



Product: 30 Inch Tilt Panel Professional Electric Range
Model Number:TRE3001

TECHNICAL DETAILS

Fuel Type	Electric
Color	Stainless Steel
Voltage	240V 50A
Frequency (Hz)	60 Hz
Controls Type	Touch Screen
Hot Surface Indicator Light	Front Right Corner of Cooktop w/ Temp at 150°F (65°C)



FEATURES & BENEFITS

- + **Five Powerful Elements** - Five elements give you great cooking flexibility with a powerful radiant cooktop. From a 100W warming zone to a high-powered 3,000W quick boil element, this range gives you the power to master any meal and the consistent low heat desired for cooking delicate sauces or melting chocolate
- + **True Convection Fan** - The true convection fan blows heat from the 800W heating element for more even heating and optimum cooking and baking results
- + **Tilt Panel** - Touch to tilt or flatten the control panel for a customizable cooking experience that offers flexibility and control of cooktop and oven settings
- + **Large Oven Capacity** - 4.55 cu. ft. oven capacity can accommodate multiple dishes at a time
- + **Air Fry** - Create healthier and mouthwatering meals using the air fry feature
- + **Multiple Cooking Modes** - Multiple cooking modes including bake, broil, roast with built-in meat probe, air fry and keep warm give you the flexibility you need to create masterful meals
- + **Storage Space** - Storage drawer provides additional storage space for cooking trays and other kitchen utensils.
- + **Hidden Bake Element** - Hidden bake element is positioned below the oven floor, creating a smooth oven surface so spills are easy to clean without maneuvering around heating elements.
- + **Self-Cleaning** - The self-cleaning cycle uses high temperature to power through soils in the oven cavity, requiring only a quick wipe down at the end of the cycle
- + **Halogen Oven Light** - The oven light illuminates your food for increased visibility

WARRANTY: 2 YEARS ON PARTS AND LABOR



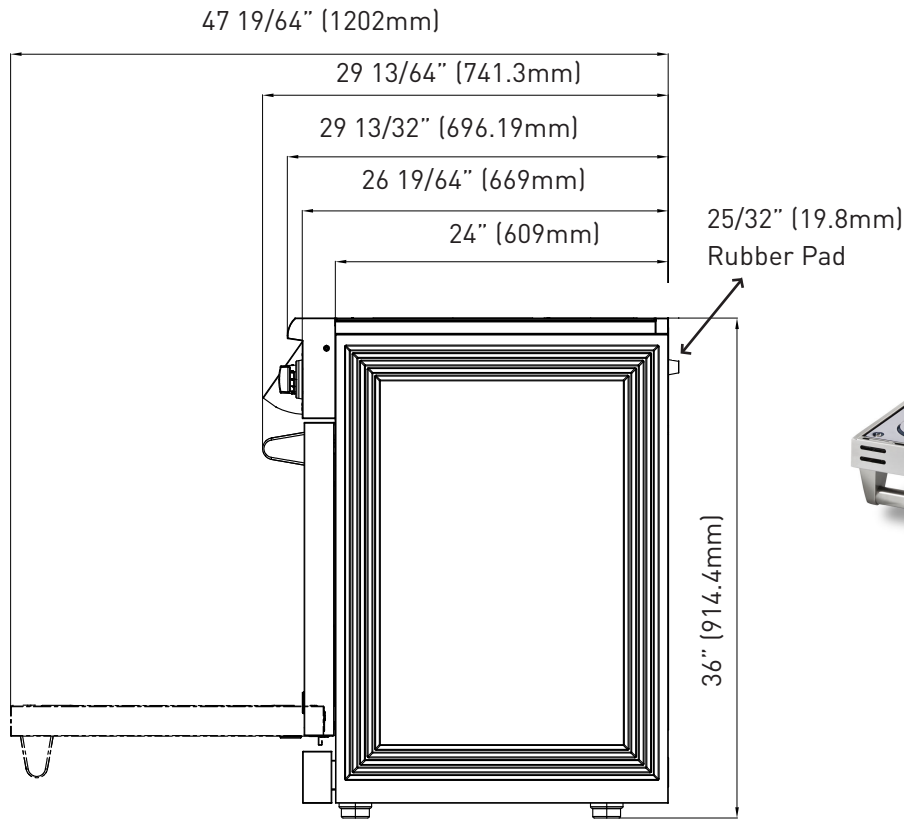

OVEN PERFORMANCE

Oven Capacity	4.55 cu. ft.
Oven Features	Air fry, Broiler in Oven, Gliding/Roll Out Racks, Hidden Bake Element, Oven Temperature Probe, Steam clean, Self clean
Oven Color	Grey
Oven Settings	Delay Bake/Delay Start, Proofing Mode
Lower Heating Element Power	3500W
Top Heater Power	3500W
Convection	True Convection with 800W Heating Element
Oven Light	1*40W Rear
Oven Racks	2
Rack Positions	6
Oven Rack Material	Chrome Plated
Baking Sheet	Fits 23" x 16" Baking sheet

ACCESSORIES

2 Oven Racks, 1 Broiler Pan, 1 Air Fry Tray

COOKTOP PERFORMANCE

Cooktop	Black Polished Plate Glass Ceramic Cooktop
Total Elements	5
[1] Front Left Element (Dual)	Outer Ring = 1500W Inner Ring = 1500W Total = 3000W
[2] Front Right Element (Dual)	Outer Ring = 1200W Inner Ring = 1800W Total = 3000W
[3] Rear Left Element (Single)	1200W
[4] Rear Middle Element (Single)	100W
[5] Rear Right Element (Single)	1200W

PRODUCT DIMENSIONS

Product Width	29 7/8"
Product Height	36" - 39"
Product Depth (including door)	26 1/2"
Adjustable Legs	3" Max
Cutout Width	30"
Cutout Height	36"
Cutout Depth	24"