

Keepplay



City Corner



BACK

Mojito Tavern

K28005

Pictures are for your reference only. The delivered goods shall prevail.

1

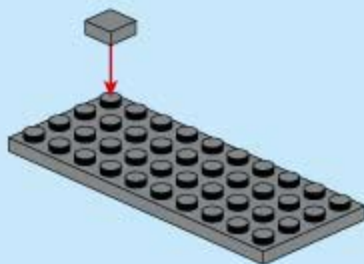
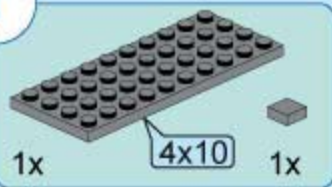

2

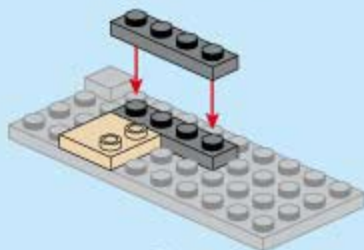

3

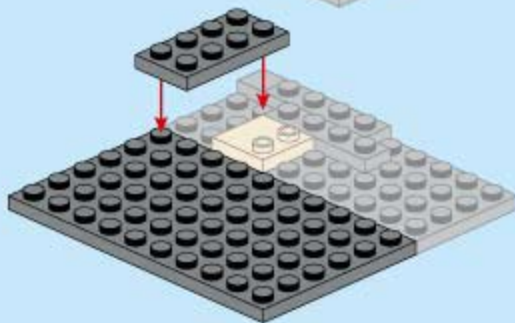
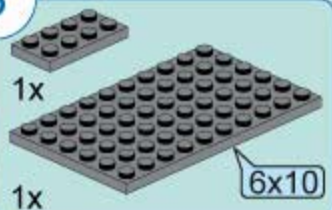

1

4

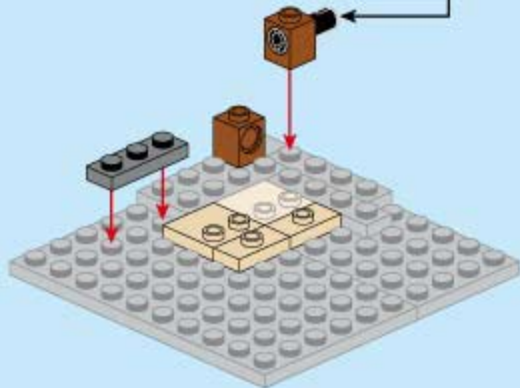
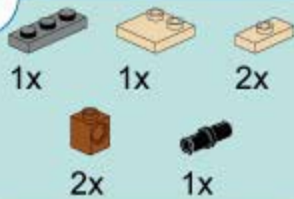

5

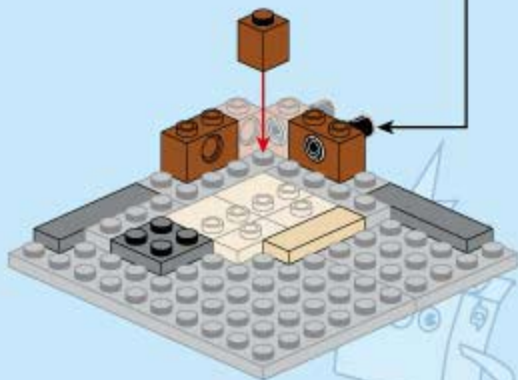
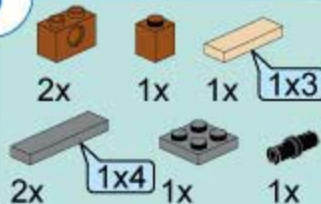

6



1x



2x



2x

7



2x



1x

1x3



1x



2x



1x



1x



3

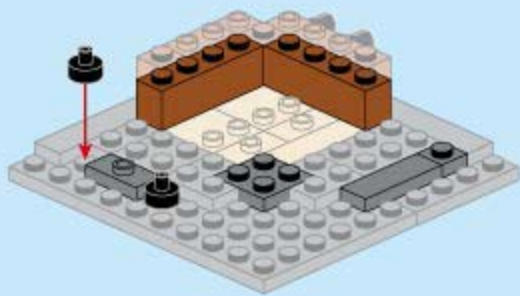

8



1x



1x



2x

1x3



2x



1:1

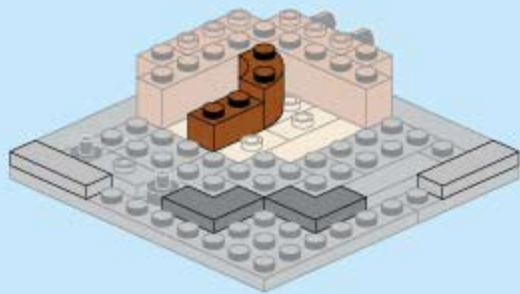

9



1x



4x



2x



2x



2x



2x

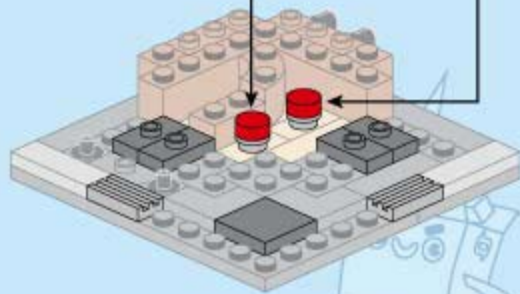

10

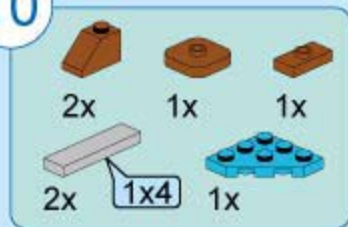

11

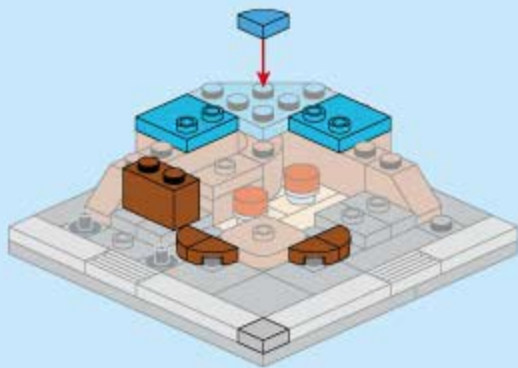
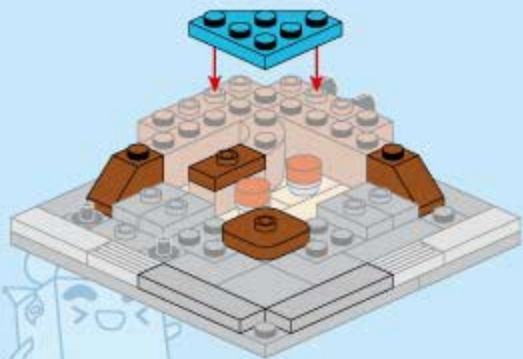
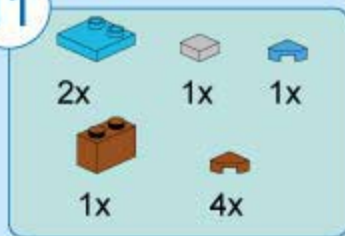

12

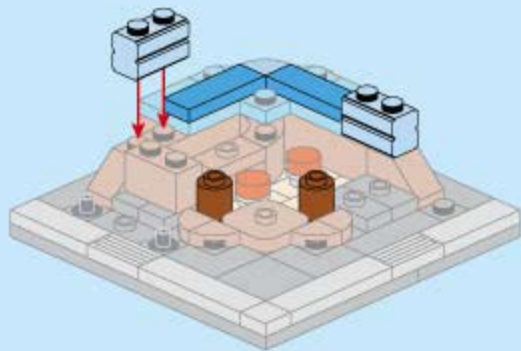
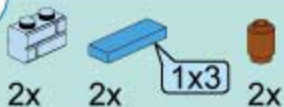

13

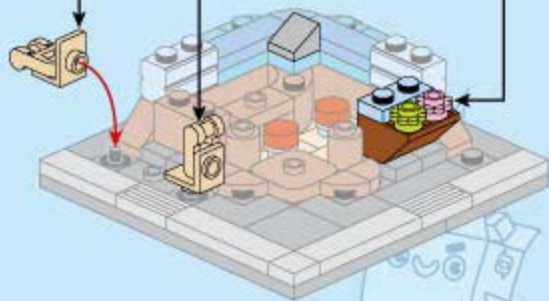
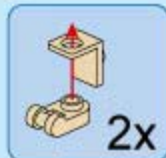

14



1x



1x



2x



1x



15



2x



1x



1x



1x



1x



1x

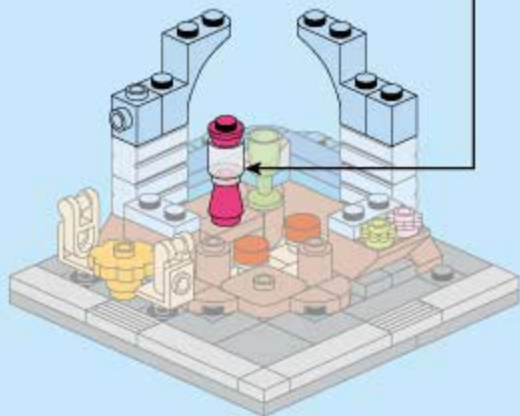
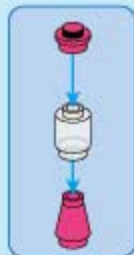

17



18

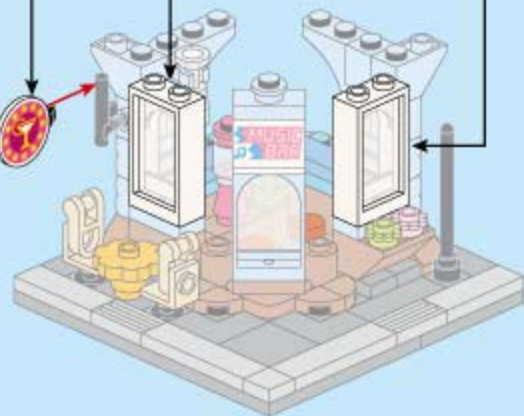
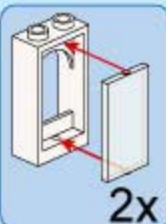
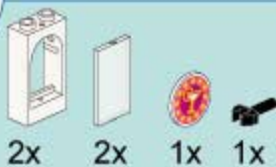

19



4x



2x

1



2

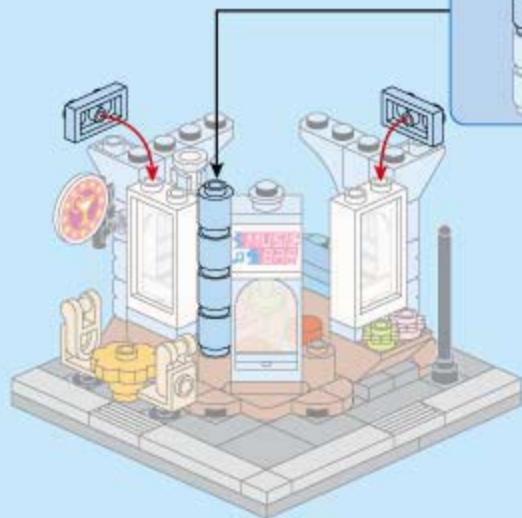

20



2x



2x



3x



1x



3x



1x

1



2



3

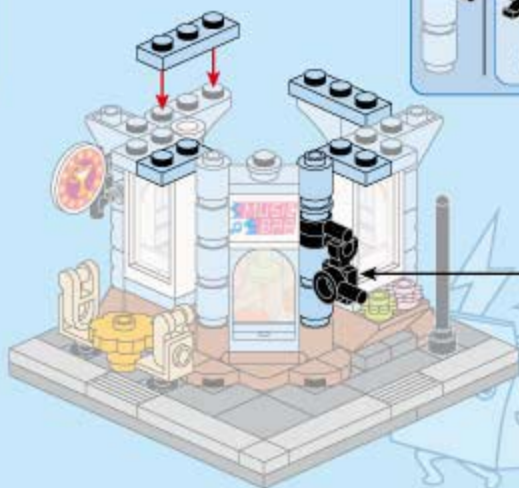

21

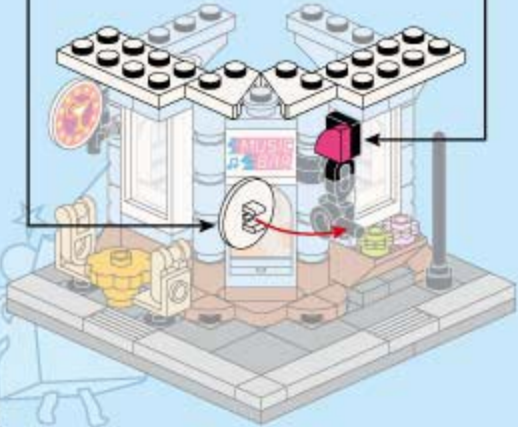

22

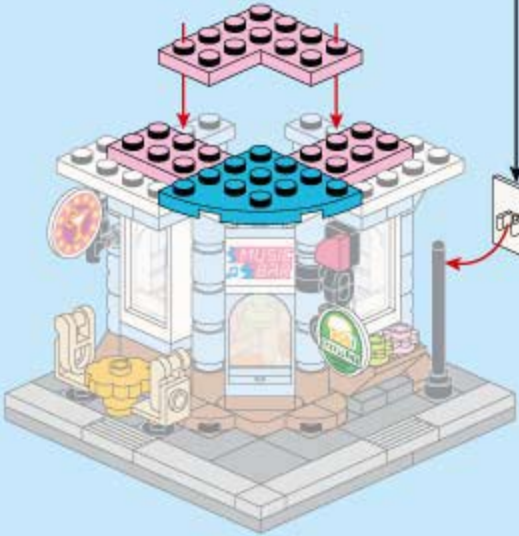
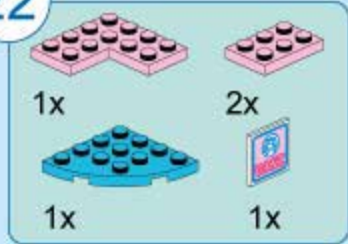

23



2x 2x 1x



24

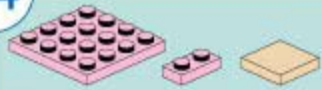

1x 2x 1x



25

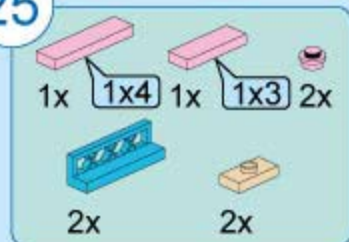

26

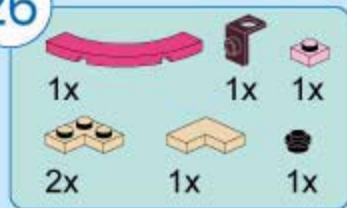

27



2x 2x 1x 1x 1x



28



1x 1x 1x 1x 1x

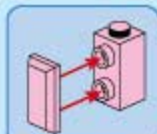

29

- 1x
- 1x
- 1x
- 1x
- 1x

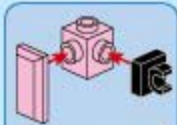

30

- 2x
- 1x
- 1x
- 2x
- 2x



31

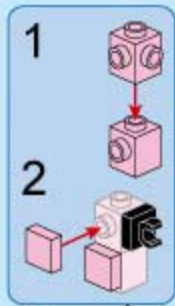
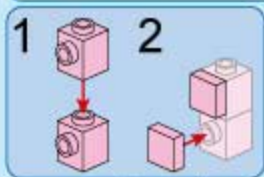
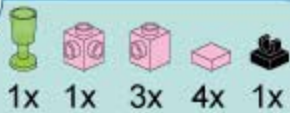

32

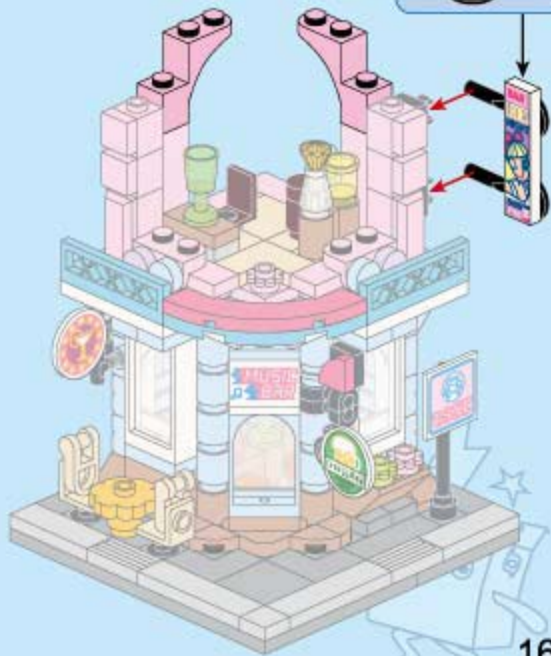

33

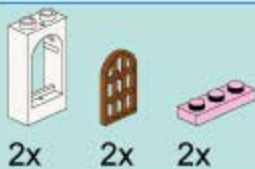

17



34

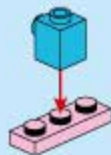

35

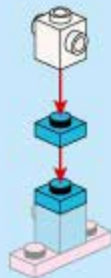

36



2x



37



1x



1x

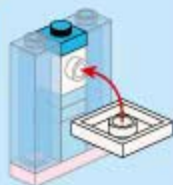

38



1x



1x

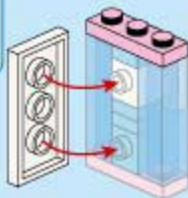

39



2x



1x



40



1x



1x



41



2x

42



2x



2x



40



43

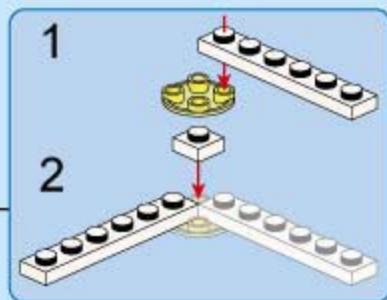
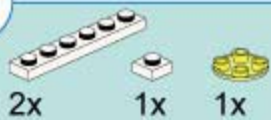

44



1x



2x

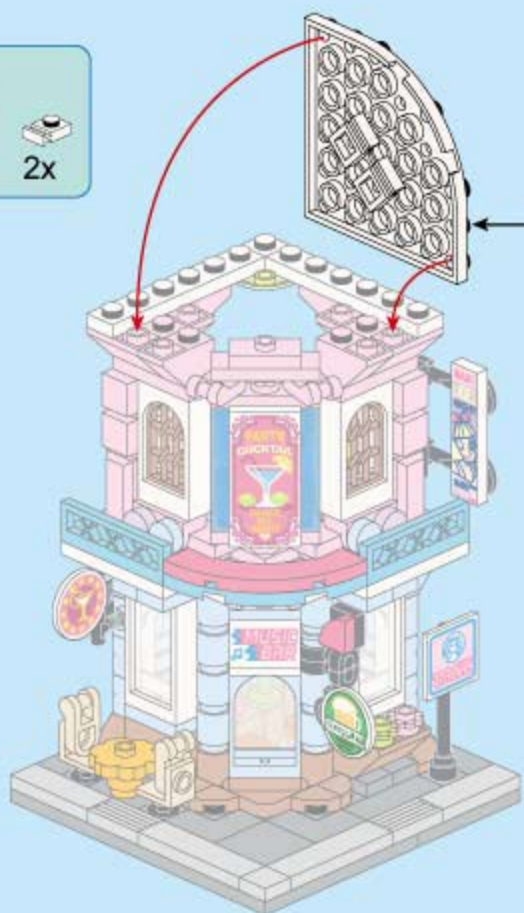
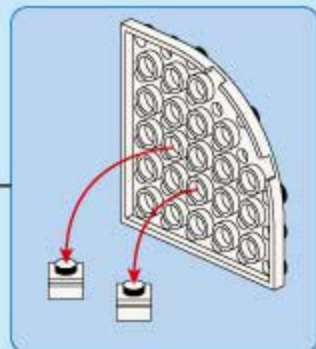

45



1x



1x



1x



46



1x



4x



47



1x

1x

1x



23

48



1x

1x

1x



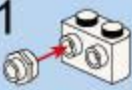
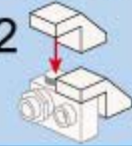

49

- | | | |
|---|---|---|
|  |  |  |
| 1x | 1x | 1x |
|  |  |  |
| 1x | 2x | 1x |
|  |  |  |
| 1x | 1x | 1x |

- 
- 

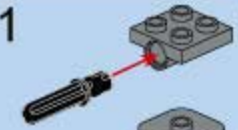

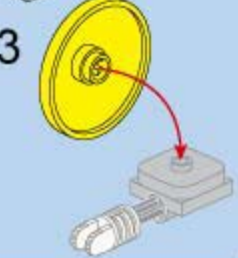
- 
- 
- 



50

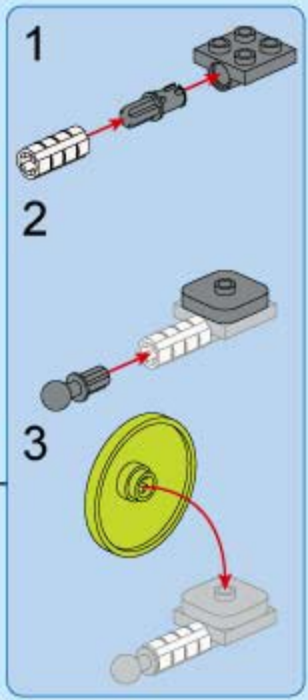
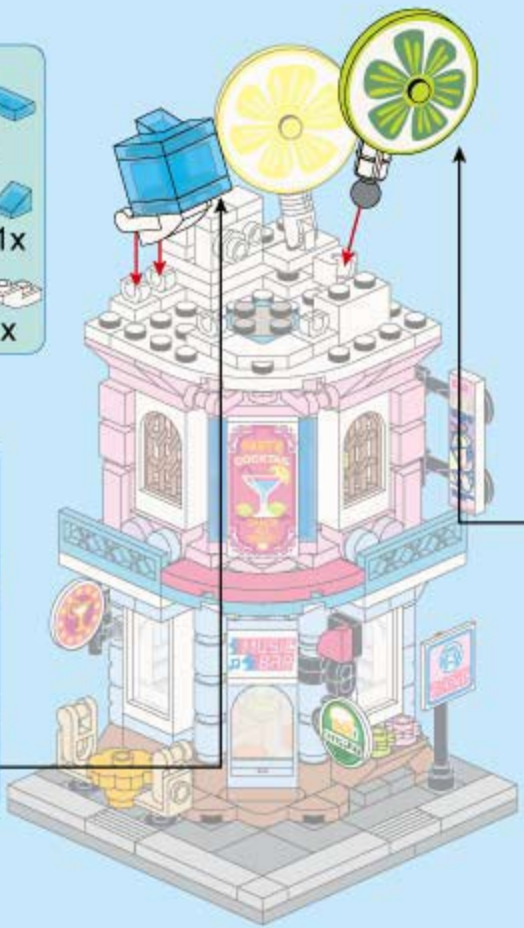
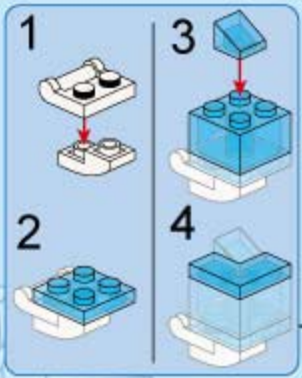



51

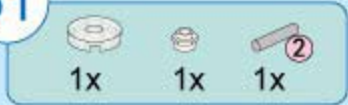

52



53

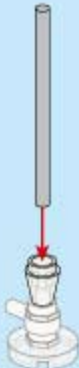

54

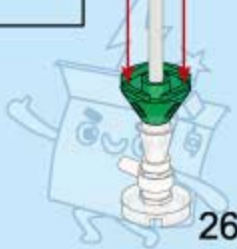
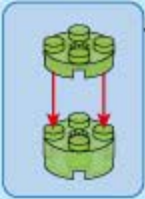

55

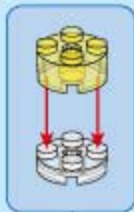

56

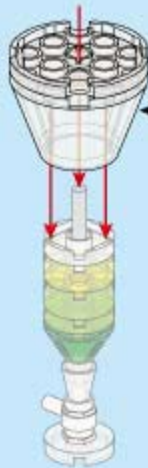
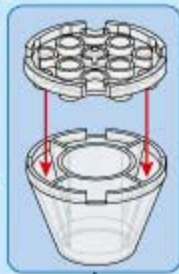
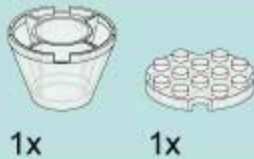

57

- | | | |
|---|---|---|
|  |  |  |
| 1x | 1x | 1x |
|  |  |  |
| 1x | 1x | 1x |

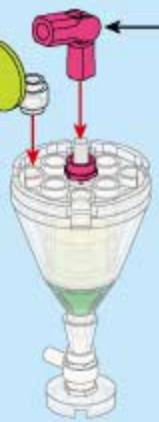
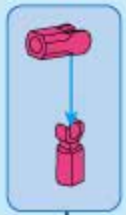
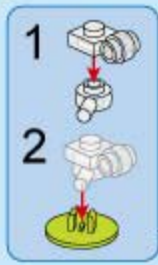





58

57





59

2x  1x4
1x  1x2
4x  1x2
4x  1x2
4x  1x2

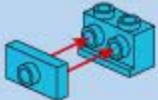

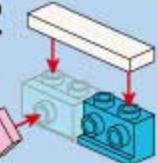
1 

2 

3 

2x



60

- 1x [White 1/2 Technic Arch]
- 1x [White 1/2 Technic Arch]
- 1x [White 1x3 Technic Brick]
- 1x [White 1/2 Technic Arch]
- 1x [White 1/2 Technic Arch]
- 1x [White 1x3 Technic Brick]
- 1x [White 1x1 Technic Brick]
- 1x [Blue 1x3 Technic Brick]
- 1x [White 1/2 Technic Arch]
- 1x [White 1x1 Technic Brick]

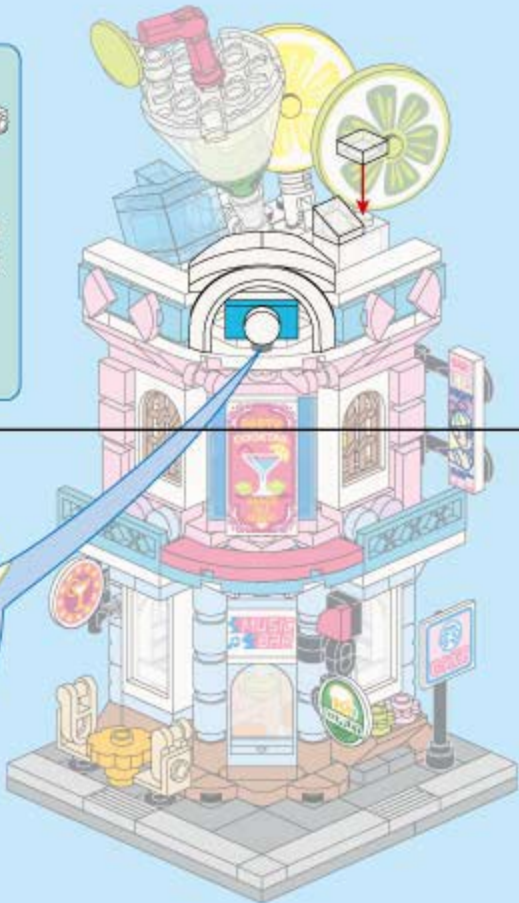
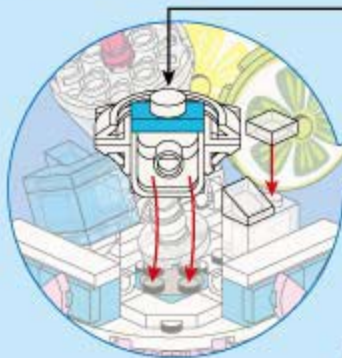

- 1 [White 1x3 Technic Brick] is placed on top of the [White 1x3 Technic Brick] and [White 1x3 Technic Brick] already on the structure. A [Blue 1x3 Technic Brick] is then placed on top of the white bricks.
- 2 [White 1/2 Technic Arch] is placed on top of the blue brick.
- 3 [White 1/2 Technic Arch] is placed on top of the previous arch.





City Corner