

The Phoenix Domes

SETUP GUIDE

Deluxe Glamping Package



Please Note: This instruction manual describes the general process for our 4-Season Deluxe Glamping Package Domes, with specifics included for any differences between 2V/3V/4V Dome sizes. Pictures are from a 6m and 8m setup.

Tools Required:

- Impact driver(s) w long 17mm (11/16") and 19mm (3/4") socket bits
- 1-2 sturdy standup ladders + rolling 9-10' scaffolding for 26'/8m or larger Domes
- A soccer ball or other common object with round edges
- A long strong rope
- hard hats for all crew members
- Driver bit(s) + screws for securing Dome feet to platform and door struts to door frame (we recommend super strong GRK screws)
- A winch, truck with tow hitch, or group of friends capable of pulling the cover over your Dome
- Scissors or exacto knife x2
- Heavy-duty zip ties (may not be necessary)
- Ratchet straps x6
- Construction level
- Measuring tape



Resources and Instructions:

Prior to installation you'll require 3 sets of documents, which you'll find located on the **Resources page** of our website and listed below. Several of them will be specific to the size of your Dome. We recommend familiarizing yourself with them in advance and downloading them to a laptop, tablet, or printing them off in advance of the big day, and ideally laminating the diagram. (phone screens are generally too small to be ideal, except in a pinch)



We also HIGHLY recommend watching our **'Assembling Your Phoenix Dome' instructional video** to get an idea of what the setup process will look like



1. **The Phoenix Domes Setup Guide** - step by step reference for installation (this is it!)
2. **Your Dome's Setup Diagram** - specific to diameter (m/ft) and frequency (2V, 3V, 4V)
3. **Interior Oxford Liner Installation Diagram** - helps you put the right pieces in the right places

2. Checking Your Delivery

It's here! It's finally here!!

Checking for Loss or Damage:

IMPORTANT! When your dome is being delivered, please make sure to **check for any damage or missing/loose items right away** and **note it on the form the driver will ask you to sign**. What you should be looking for with different kits can be found on our website the link at the bottom of the page. Make sure to clearly indicate any issues, **or even simply potential issues that you may not be certain of**. It is far better to indicate a potential problem on the sheet and to figure it out later with our help rather than not do so and miss the opportunity completely.

Without noting problems, we cannot make a claim in the event of damages.

Please check your delivery immediately and make sure everything is there and in good shape.



What to Look For:

Please check for any holes, tears, rips, damage to the crates or any cardboard boxes, any openings in crates that struts etc could potentially have escaped from, or possible missing items ASAP, before signing the delivery slip.

Unfortunately, we have been subject to negligent carriers refusing our damage claims because these forms have not had the relevant issues noted down at time of delivery. **If you are only reporting damages later, we cannot be held responsible.**

[IF YOUR DOME IS NEARING DELIVERY OR EN ROUTE,](#)

[CLICK HERE FOR FULL DETAILS REGARDING WHAT TO LOOK FOR UPON ITS ARRIVAL](#)

Caution: Cold Crack risk

The clear PVC material gets brittle in cold temperatures. Please avoid installing your dome cover in temperatures below 10 degrees Celsius / 50 Fahrenheit as moving, unfolding, pulling and tensioning the panorama window and skylights could result in cold crack damage.

Once the material is installed, it is able to withstand cold temperatures as long as there is no major movement or impact to it while it is cold.

3. Get to Know Your Struts and Hardware

Begin unloading the various crates of your Dome. You'll want to get the struts and hardware up onto your platform so they're close at hand, but the large/heavy bundles composing the Dome cover, bubble liner insulation, and Oxford liner are fine to stay off to the side for now

Each strut has 2 numbers stamped into the metal at both ends

- The 1st number corresponds to your Dome size in metres (5, 6, 7 etc)
- The 2nd is the number of the strut itself, which corresponds to your Dome's Setup Diagram

Separate your frame struts out into piles as per the numbers stamped. You may find it helpful to mark each of the numbered strut types with coloured tape or marker to prevent time-consuming errors during assembly

Bear in mind, the numbers, variety, and quantities of your struts will vary depending on your Dome's size and frequency (2V, 3V, 4V). As per our [Resources page](#), you'll find different Setup Diagrams for our:



this strut is a 6-1

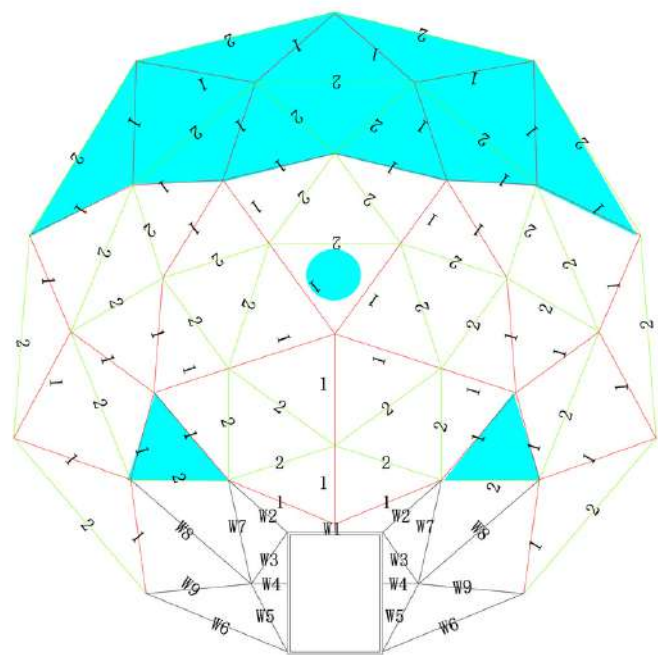

5m 2V Domes

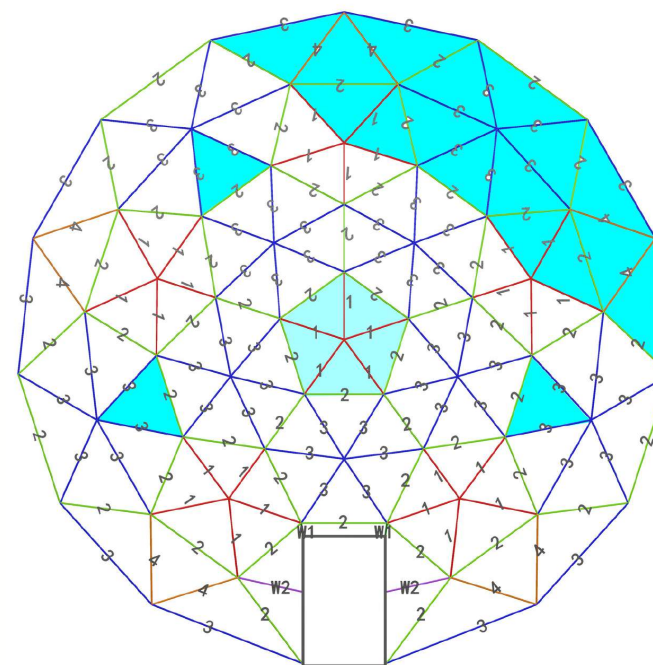

6, 7, 8m 3V Domes

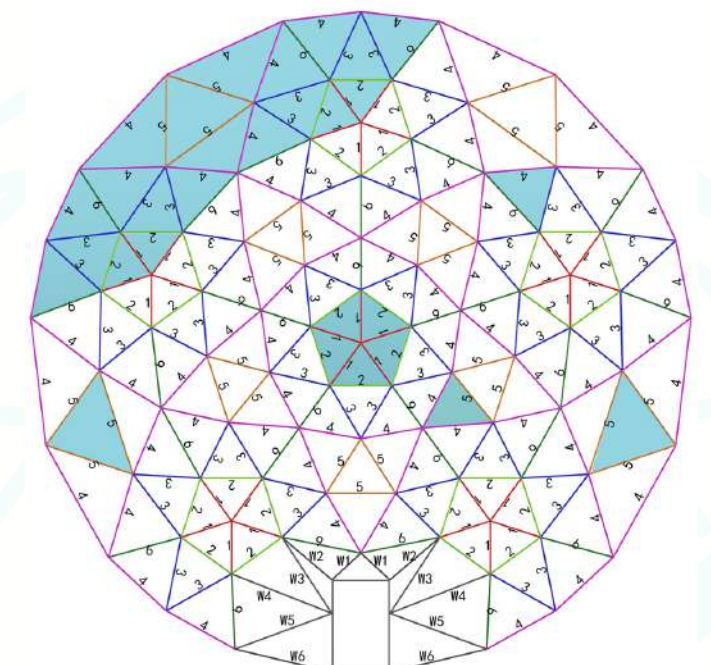

9m+ 4V Domes



Bracket Feet



Frame Nuts and Bolts
(M12, use 19mm socket)



Strut Clips and Acorn Nuts



J-Hooks and Bolts
(M10, use 17mm socket)

Curtain Brackets (only for
some domes)



Curtain Hardware



Tension Bars

Door Frame Struts (W-Series)



4. Frame Assembly

Let's get this show on the road!

Base Row:

A) Lay Out Your Perimeter

- If you have an exact fit Dome platform, begin by placing an angle bracket at each corner of your platform, then place your numbered struts in a 3-3-2 pattern all the way around as per the diagram. The door replaces a #2 strut.
 - For other platforms, begin placing numbered frame struts in a 3-3-2, 3-3-2 pattern all the way around to roughly determine your perimeter, followed by angle brackets. You may need to adjust your Dome's orientation later on (before it gets too heavy!) to face the direction you want
- Orient everything around the location of your future door
 - For 3V Domes, you can get the spacing right by temporarily using a #2 strut as a placeholder for the doorway before removing it later on to use in its proper place
 - For 2V and 4V Domes, you can leave about a 38" space for the door frame.
- 2V Domes (from doorway) will start with W6-2-2-etc
- 4V Domes will start with W6-4-4-etc. Always refer to your specific diagram!

B) Loosely Connect Everything Together

- When using an exact fit platform, have the bolt facing inwards but attach the bracket on the inside facing outwards, or attach the bracket on the outside facing inwards, so that it can be anchored into the perimeter joists of your platform with long GRK screws for superior anchoring. If necessary, foundation tie plates can be attached to the bolt on the outside and screwed into the sided of the platform for additional anchoring.
- On a larger deck the brackets can be on the outside of the frame or as desired.

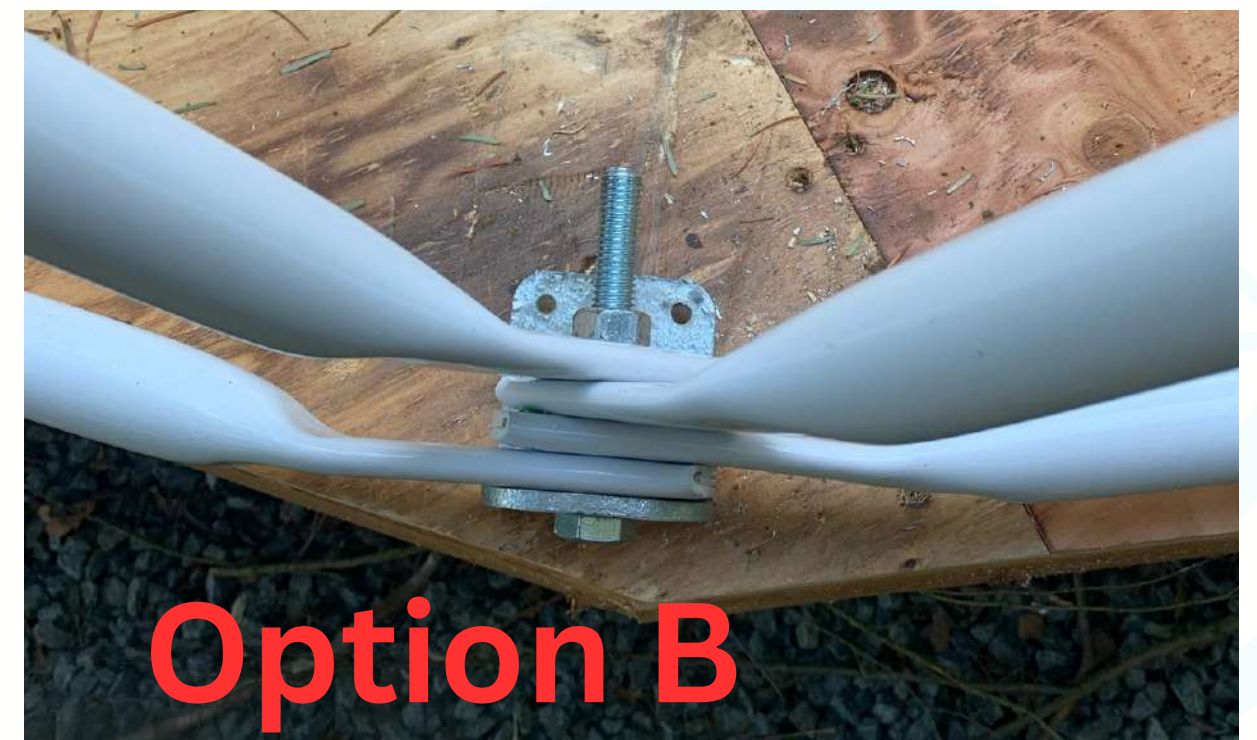

C) Get to Know Your Setup Diagram

- #1 struts form 5-pointed stars
- #3 struts form 6-pointed stars
- #2 struts form the perimeter of the pentagons and hexagons created by #1 and #3 struts
- #4 struts are used only in the first layer
- You'll notice similar patterns for 2V and 4V Domes

D) Lay Out Your First Vertical Layer

- Starting from the door, this will be a repeating 2-4-4-2-3-3 pattern (referring to the diagonal struts in the next layer after the base row you've already laid out)
- You may also want to lay out your 1st row of horizontal struts so they're ready for future (W2-2-3-3-etc)

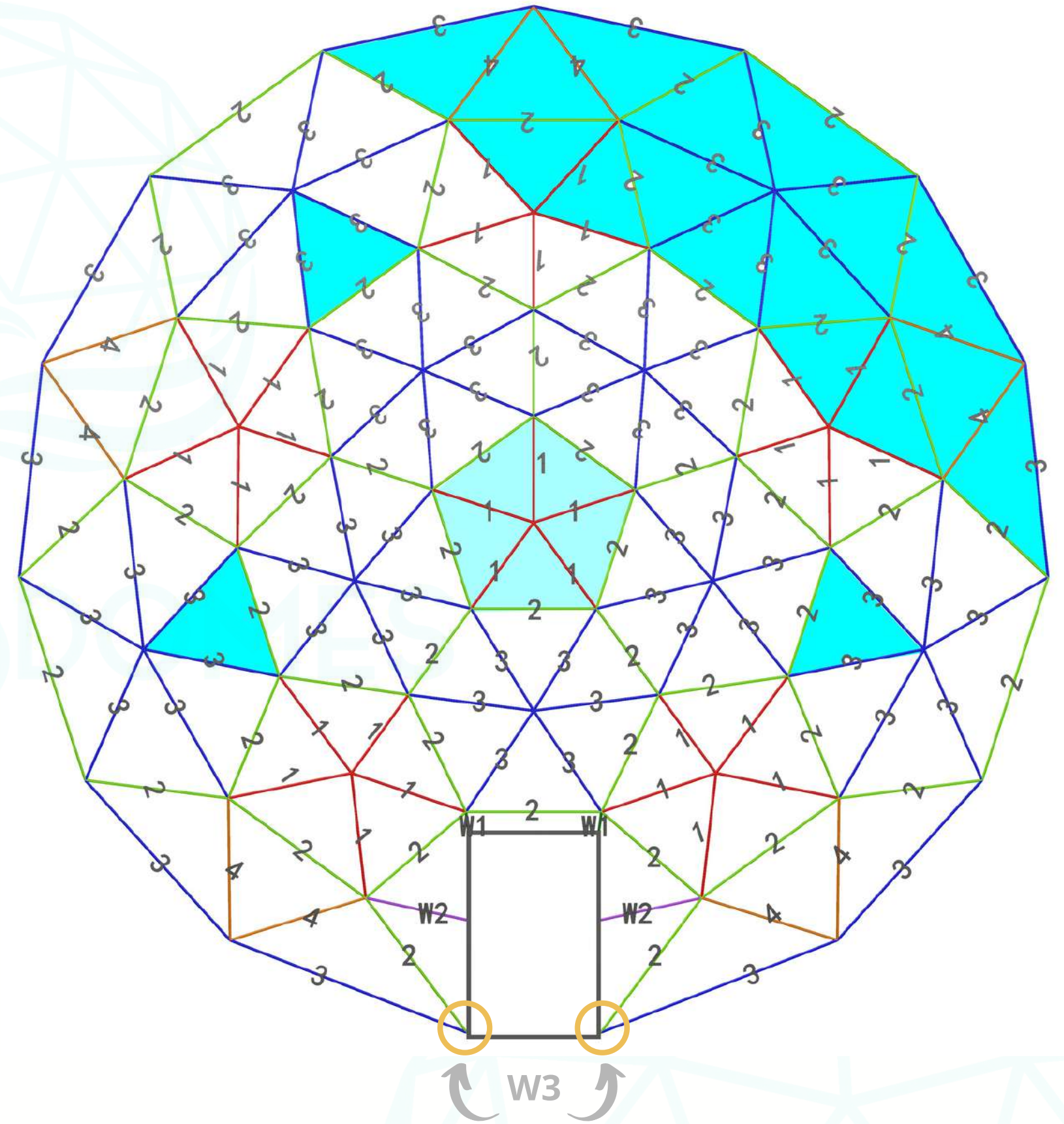

7m and 8m 3V Domes will also have short 'W3' door attachment bars that join your door frame to adjacent bracket feet on either side

E) Secure Your Bracket Hubs

- Now that these hubs in the base row have all 4 struts present, you're ready to add nuts and tighten them down
- Use your impact driver with long 19mm (3/4") socket bit



First Row:

A) Assemble Your First Row

- Work your way around the perimeter, adding each successive horizontal bar and securing it in place with a loosely fastened nut

B) Assemble Your Pentagons

- Notice on the diagram how your Dome has a total of six 5-pointed stars composed of #1 struts
- 5 attach to your first row, and the 6th at the centre of your ceiling
 - This is the case for all 2V, 3V, and 4V Domes
- Take a moment now to loosely bolt together 4 of those 5-pointed stars you are about to require as you go about assembling your Second Row (leave the 5 for the center top loose)



C) Add Your Pentagons and Second Layer

- Go around again and add the full complement of struts to each hub of your First Row
- For 3V Domes, the pattern will be 2-Pentagon-2-3-3-2-Pentagon
- Add the W-series door frame struts and just leave them hanging loosely for now



Install windows/ Window frames

Please note that there are a few different methods for triangle window installation, depending on the dome size and version. For some deluxe dome kits, there are tubing pieces that serve as a stand for the window.

- If you have these, determine now which 2 out of the 3 possible window locations you want to install the windows in and replace the 2 struts on either side of those triangles with the square tubing. Make sure the Rivet nut is on the outside.
- You can swap them out later but it will be harder. The window needs to be installed before the cover goes on, but can be after completing the frame.
- If you have a window with **'ears'**, or a **'triangle stand'**, you do not need to install those at this moment.



Tubing pieces to add during frame build



Install windows/ Window frames - with square tubing (skip this step if you have a window with ears or a triangle mounting frame).

- These windows need to be installed in the rectangular frame once the frame is complete, before pulling the cover.
- Place the window into the crook of the triangle, with the opening point / handle down.
- lock it in place with the top square bracket and affix that one with a short bolt into the rivet nut on the 2 side pieces of the frame.
- While someone is pushing firmly on the window frame from the inside, open the window. (careful it might fall while open until screwed in - make sure someone is pushing/holding it! Then use a few of the self-tapping metal screws to solidly attach your window into the outer frame through the holes provided. .

Installed square Tubing frame



Install the upper square frame piece

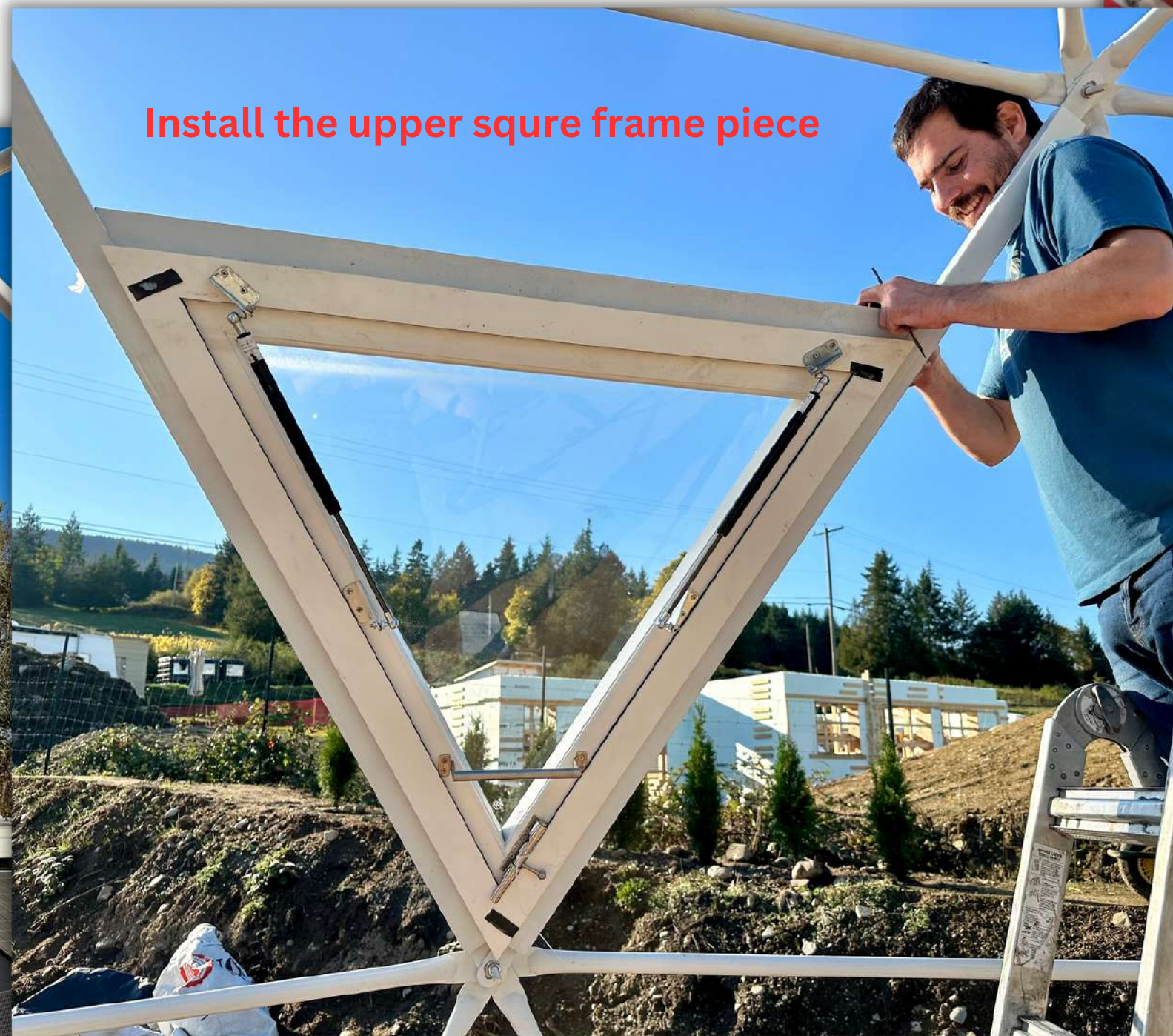

screw the window onto the frame



Second Row:

A) Assemble your Second Row, Starting from the Door

- Working as a team, make your way around the perimeter
- Again, as hubs are completed with their full complement of struts (6 in all cases except for your 5-pointed stars), lock them in with your impact driver
- Once your second row is complete, go around and add the next layer of vertical diagonal struts to each hub, hanging down for now - this will reduce your ladder or scaffold work, making you safer and speedier

B) Safety First!

- Metal struts are heavy, awkward, and can be slippery in wet conditions or with gloves on
- You're far better safe than sorry - **put on a lid!**
- Regardless, take care to ensure helpers on the ground avoid walking underneath active work areas and the potential for falling struts



Door Frame - best attached when the 2nd layer of struts is being built

- Our Domes are designed to accommodate a standard 36x80" pre-hung exterior door, which are available at any building supply.
- The Deluxe Glamping Package comes with a metal door frame with mini awning to protect your door from the elements.
- Assemble the awning/frame according to the diagram
- please note that we currently have 2 versions in our collection that are ever so slightly different - version 1 is depicted on this page, version 2 on the next.

Version 1:

- bolt the bottom and top side pieces together
- then join them at the top
- attach the door frame to the dome frame
- Make sure to screw down the bottom piece with the same distance between the sides as at the top so it cannot pull apart.

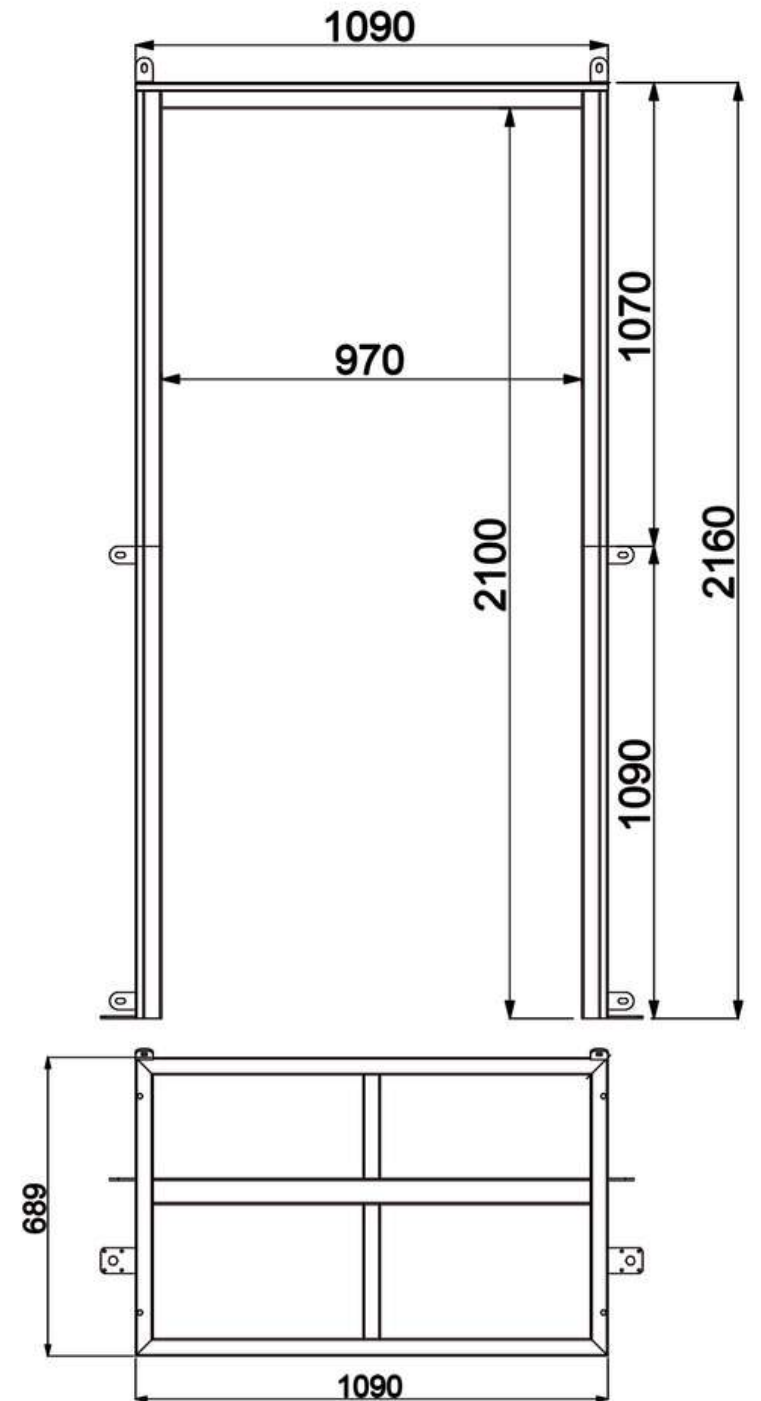
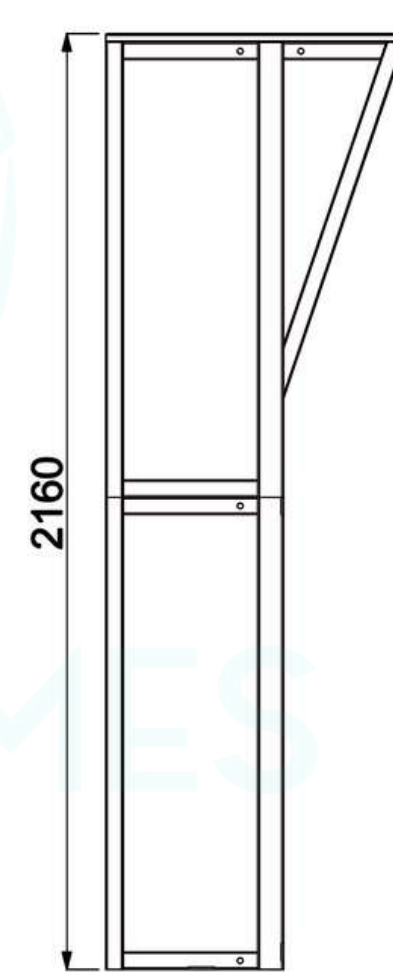
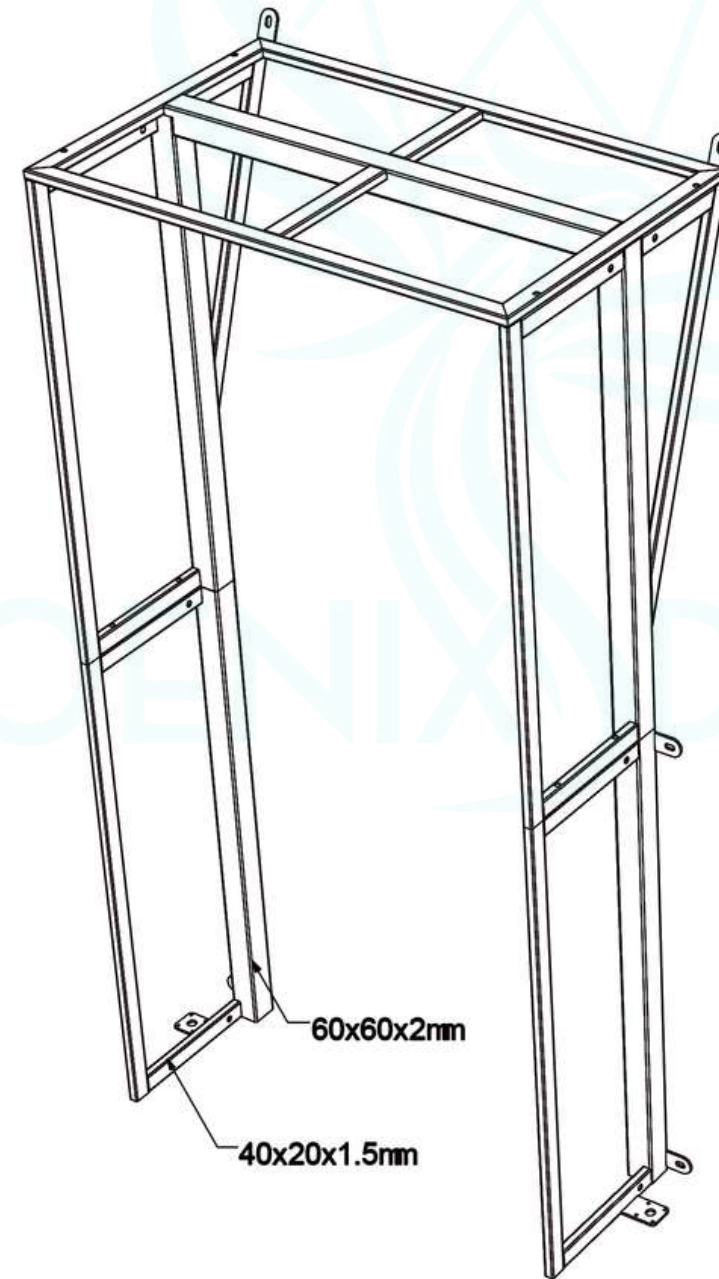

6m Dome Door Frame

Mini Awning Version2

- bolt the side and top pieces together
- then join them at the bottom
- attach the door frame to the dome frame via the attachment struts

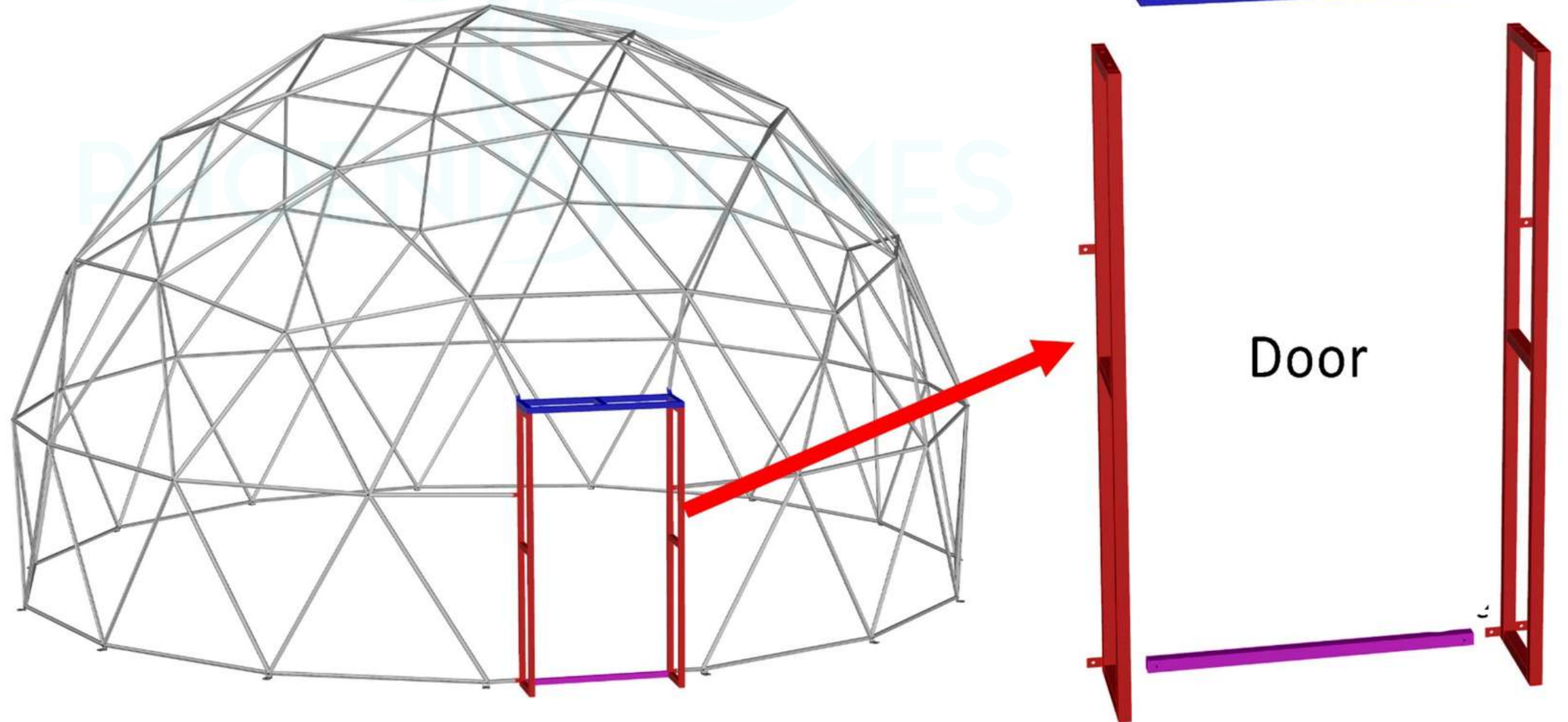

More pictures of Door frame assembly:

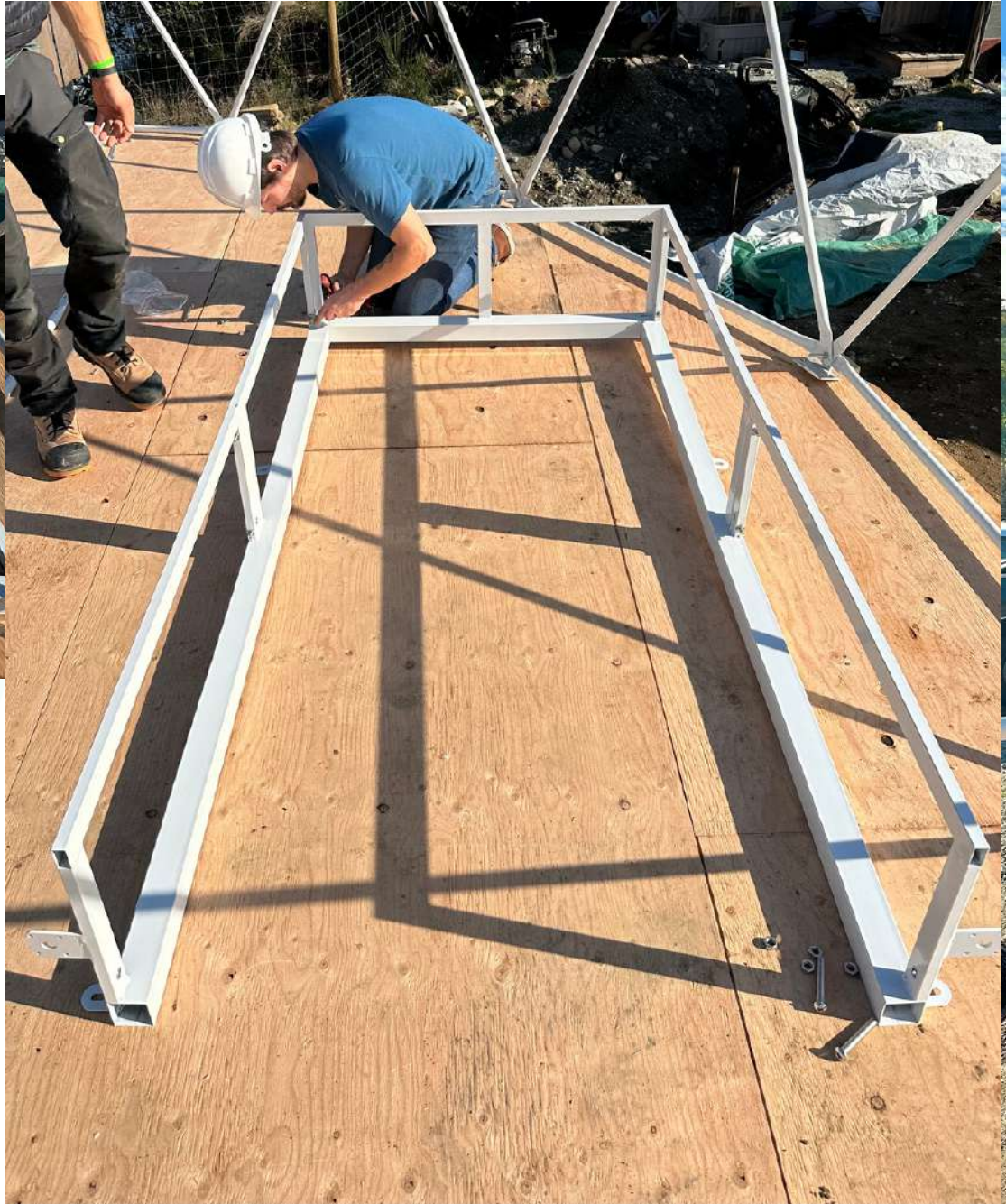

Please note: a small landing will need to be built for the door awning, which can be integrated with the stairs you will inevitably need to build for the platform.

Third Row:

A) The Dance Continues!

- We'll say it one more time... be extra careful on your ladder or scaffolding as you reach these higher rows!
- Use your dangling struts with the addition of new horizontal bars (and the next row's vertical bars) to continue working around the frame
- Tighten freshly completed 2nd row hubs with your impact driver as you go
- As before, leave the next layer of vertical struts loosely hanging and ready for the next stage

Fourth and Final Rows:

A) Keep On Rolling

- Use your hanging struts, and add your horizontals and one extra to each hub for your final central 5-pointed star
- Make sure to fully fasten each 3rd row hub while your ladder is close by (less of a problem for ground-level hubs)

B) Complete Your Central Pentagonagon

- Every single hub should now have been bolted together tightly with your impact driver. If this is not the case, tighten up any that were missed earlier on
- Your Dome should now feel rock solid! It will be perfectly fine for kids to climb on at this point, but be careful that adults place their feet close to the hubs where the structure is strongest if they want to play around :)
- CELEBRATE!



Extra tips and tricks:

- Especially for larger domes, once you get to the 3rd row and up, it can be very helpful to have a tool to pass struts that are attached on one end up to the workers on the ladder or scaffolding. One of our customers invented an especially nifty little tool - a slingshot taped to a wood stick! 'Wolfy' came in very handy and sped up his 8m setup considerably.

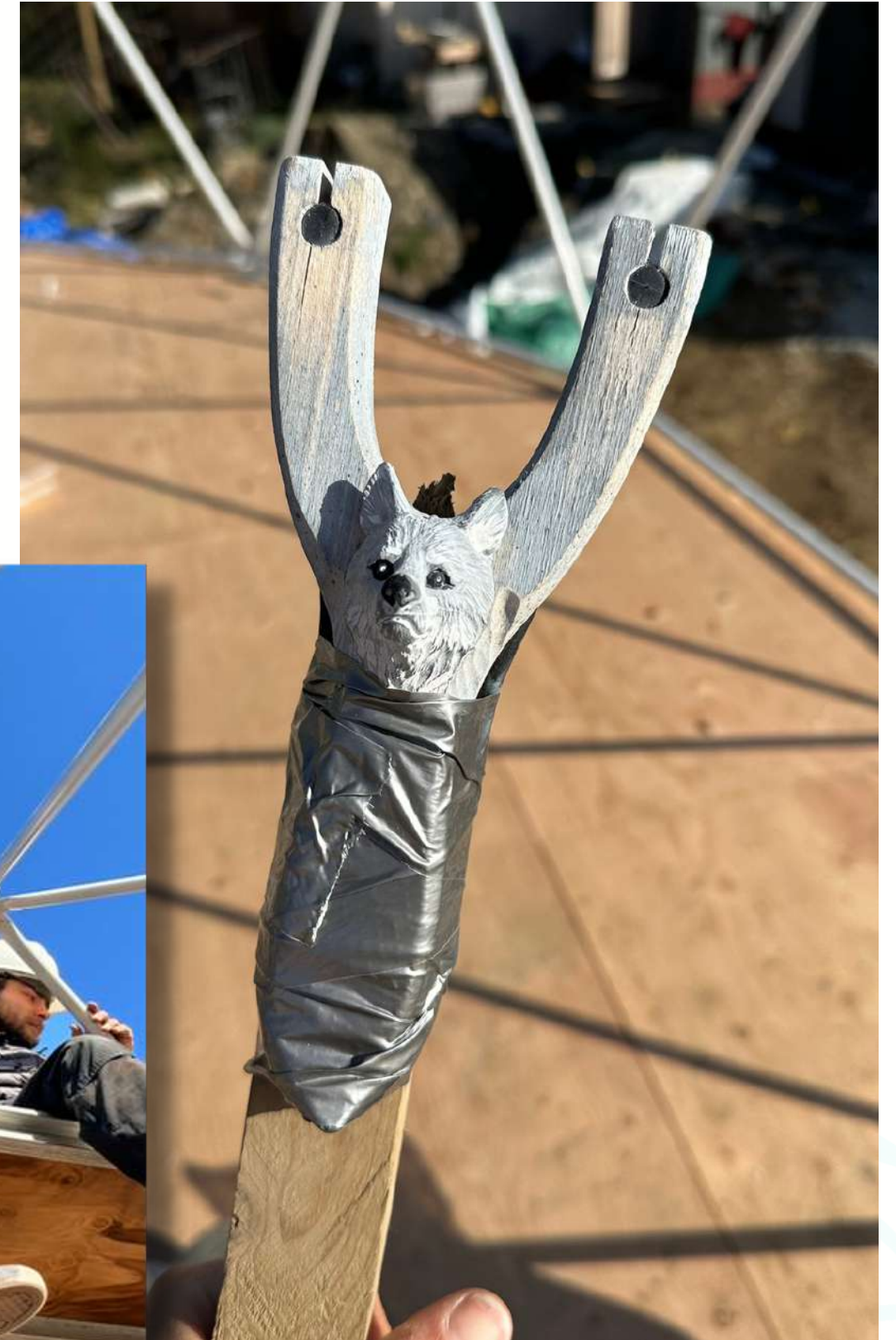

Extra tips and tricks:

Scaffolding

- for domes 8m and up, scaffolding is essential for safety. An 8-10' high rolling scaffolding is ideal with a team of 4 - 2 people can comfortably work on top of it, while 2 people below can push the scaffolding to the next spot and hand up the struts and tools required.
- **Teamwork** is most efficient! Have one designated team leader who has the diagram and determines which strut goes where, others will follow their instructions, hold, tighten, pass struts etc. This way it is much easier to avoid time-consuming errors than multiple people working on various parts of the dome, and it usually goes quite smoothly.



Bracket Feet

A) Secure Your L-Bracket Dome Feet

- Ensure your frame is centered and its vertices are correctly positioned in relation to the vertices of your platform, and shift or rotate your frame slightly if necessary
- Switching your drill to a driver bit, usually a Torx bit for GRK screws, secure your anchor feet to the platform with screws through the two smaller holes in each L-bracket
- If you don't have GRKs available, you can always use regular wood screws now and replace them later on (shown right)
- Please note that we recommend the feet facing towards the outside for exact fit platforms - see image below - so that the screws go into a perimeter joist.

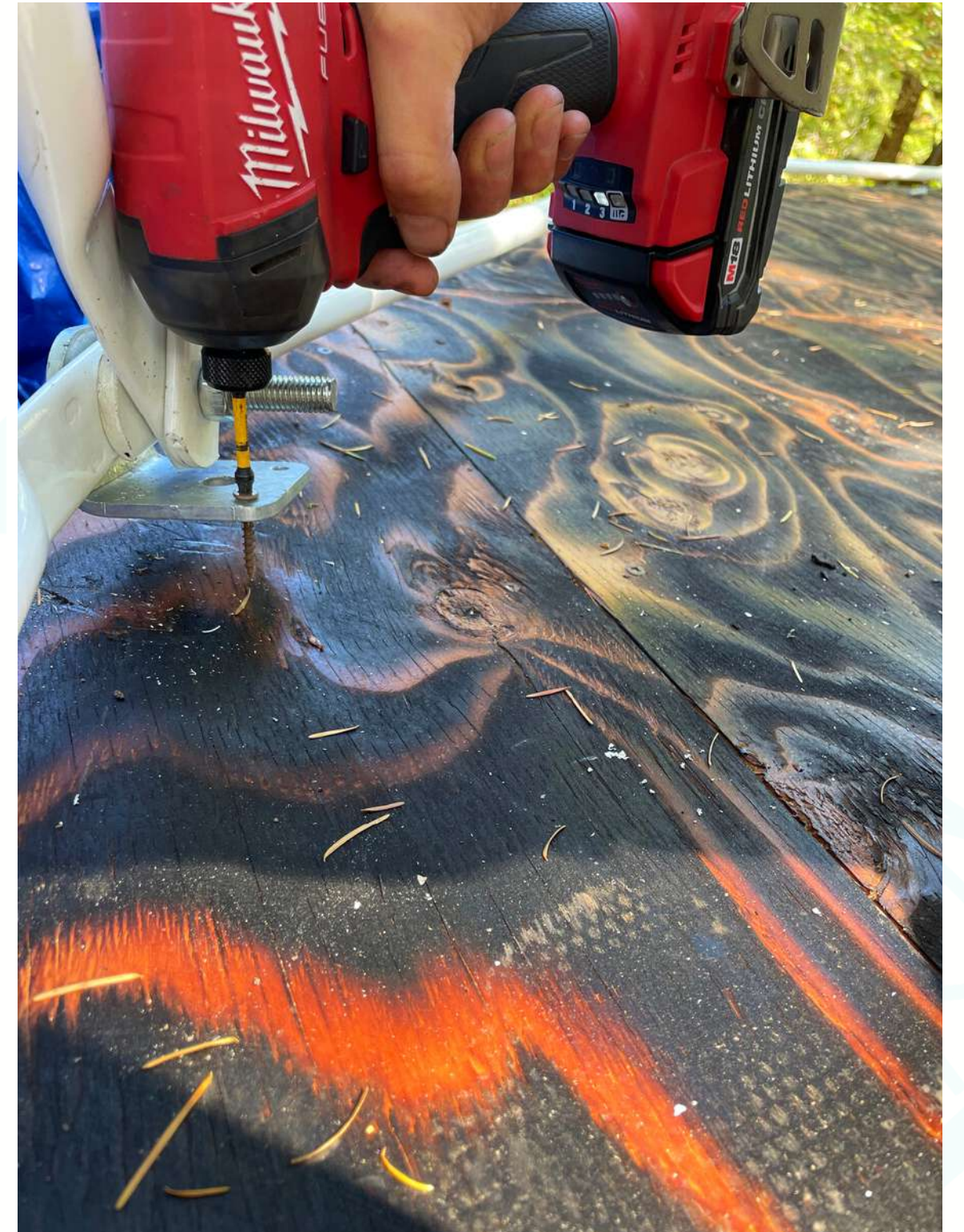

5. Outer Cover

A) Winch, Truck, or People Power?

- The first thing to consider is the direction you'll be pulling your cover up and over from
- Regardless of pull method, you want to ensure you've got an appropriate amount of space on the side of the Dome you'll be pulling from, AKA your 'runway'
- Boat winches can be attached temporarily to the structure of your platform for domes 7m and under. this also works well where there is limited space. Truck winches are also a great option!
- An alternative is to simply tie a rope to a vehicle. For this method to work, relatively smooth terrain and more runway will be required
- For smaller Domes in areas of rough terrain it may be preferable to use people power, which requires low to moderate runway (you'd need quite a few friends for this, ~5-8 people for a 5m or 6m Dome)
- Take a moment now to move your unopened cover bag to the opposite side of the frame from which you will be pulling

B) Unfold Cover, Zip In Window

- Unfold your outer PVC cover as best you can, noting the large and obvious zippered section that's missing (all of our newer glamping packages include a zip-off panorama window)
 - You may want to lay down protective tarps, cardboard, fabric, etc to protect your window on rough ground
- Locate the panorama window inside its protective fabric (same large bag as outer cover) and unfold this as well. Take even greater care not to scratch or damage your window!
- Orient and align the zipper tracks of the outer cover and panorama window and carefully **zip them together**. Failing to do so will create massive headaches for you later on!





C) Create Your Pull Point

- With your completed cover now unfolded, orient it such that your pano window and doorway cutout are in roughly the correct places they should end up after you've pulled your cover on. Counting the number of tension sleeves on the inside bottom of the cover will give you an idea of how many sides away from the door/ window your pull point is
- Find the edge that will end up on the far side of your Dome after pulling, in line with the pull path you already determined. Now find a region of the cover along that edge that is neither near the door cutout, nor part of or close to the panorama window
 - This prevents excess stress on the window, zipper, and door seams during the cover pull
- Tie a rounded object (soccer balls work great!) into this edge region with your rope

D) Cover Pulling

- Attach the rope to your winch strap if necessary, and begin cranking the winch, or pulling with your vehicle, while other team members spread the cover out in the process by pulling sideways and pushing it upwards from the back
- Pull slowly, and be sensitive to any resistance, which is usually due to your cover catching on something. When this is the case, stop pulling, free the cover, and continue
 - Pull VERY slowly if using a truck, and make sure there is good communication between the driver and people checking the cover, to stop the truck or winch if the cover gets stuck!
 - For smaller domes, it helps to have a 2x4 with cut ends, some PVC pipe, or a similar long sturdy object with a blunt end to push up and help encourage the cover over any difficult spots - for larger domes, have a team member on the scaffolding doing the same.
 - If you have a gas-powered leafblower (electric options aren't powerful enough), blowing straight up from inside the Dome can be a great tactic to reduce friction during the cover pull!
- Sometimes the panorama window can be particularly sticky and needs some extra pushing from the inside to make it slide.





E) Cover Pulling II

- In the final stages, pulling the cover down as a team will often be necessary
 - You can insert one of the tensioning pipes (pictured next page) into its tension sleeve in order to have a nice handle to pull from
- Finally, ensure the door cutout lines up with your door frame
 - A certain amount of rotation and further encouragement will be necessary! Again, it helps to equally space partners along the perimeter of the Dome and perform a few sharp tugs as a group on the count of 3
- Don't forget to untie your pull point!
- From the inside, make sure the skylight lines up nicely with the upper pentagon of your frame



6. Interior Tensioning

The tension right now is killing me...

A) Preliminaries

- Locate your long straight tension tubes, J-hooks, and the smaller nuts intended for the J-hooks
 - The shorter tension tubes will be used later on around your panorama window!
- Go around and insert a tension tube inside each horizontal sleeve around the perimeter
- Slide J-hooks under the horizontal struts in the base row and up through the holes in the tension tubes, and screw on one nut finger-tight whenever it's possible to do so (if they don't reach, see next page)
- Occasionally some of the J-hooks can be too narrow to hook around the struts of the base row if you have the heavy frame. In this case, simply use a pair of tension tubes as levers to spread them out slightly further as necessary



B) Secure Your Door Frame

- Here you'll use a pair of ratchet straps to prevent your door opening from being stretched out during tensioning
- Slide tension bars into the vertical sleeves (if present) on either side of your door frame
- Temporarily apply even tension from one bar to its opposite across the doorway using ratchet straps, one secured above and below each sleeve
- These straps will be removed and the tension tubes repurposed later on once all but two of the horizontal tension bars in the base row have been fully tightened down



C) Ratchet and Tension, Starting from the Door

- Drop down to the horizontal tension tubes of the base row on either side of your door frame
- Using 1 ratchet strap per J-hook (where necessary), hook both ends around the upper hub above your first tension tube, looping under the horizontal strut in the base row, and then sliding the loop end around the tension tube. Make sure to hook the ends only to the hubs, not the middle of the struts, as they can bend under tension!
- Now you can use the ratchet to pull the end of the tension tube down towards the base row
- Hook a J-hook under the base row strut, run its straight end through the tension tube, then finger-tighten a nut into place

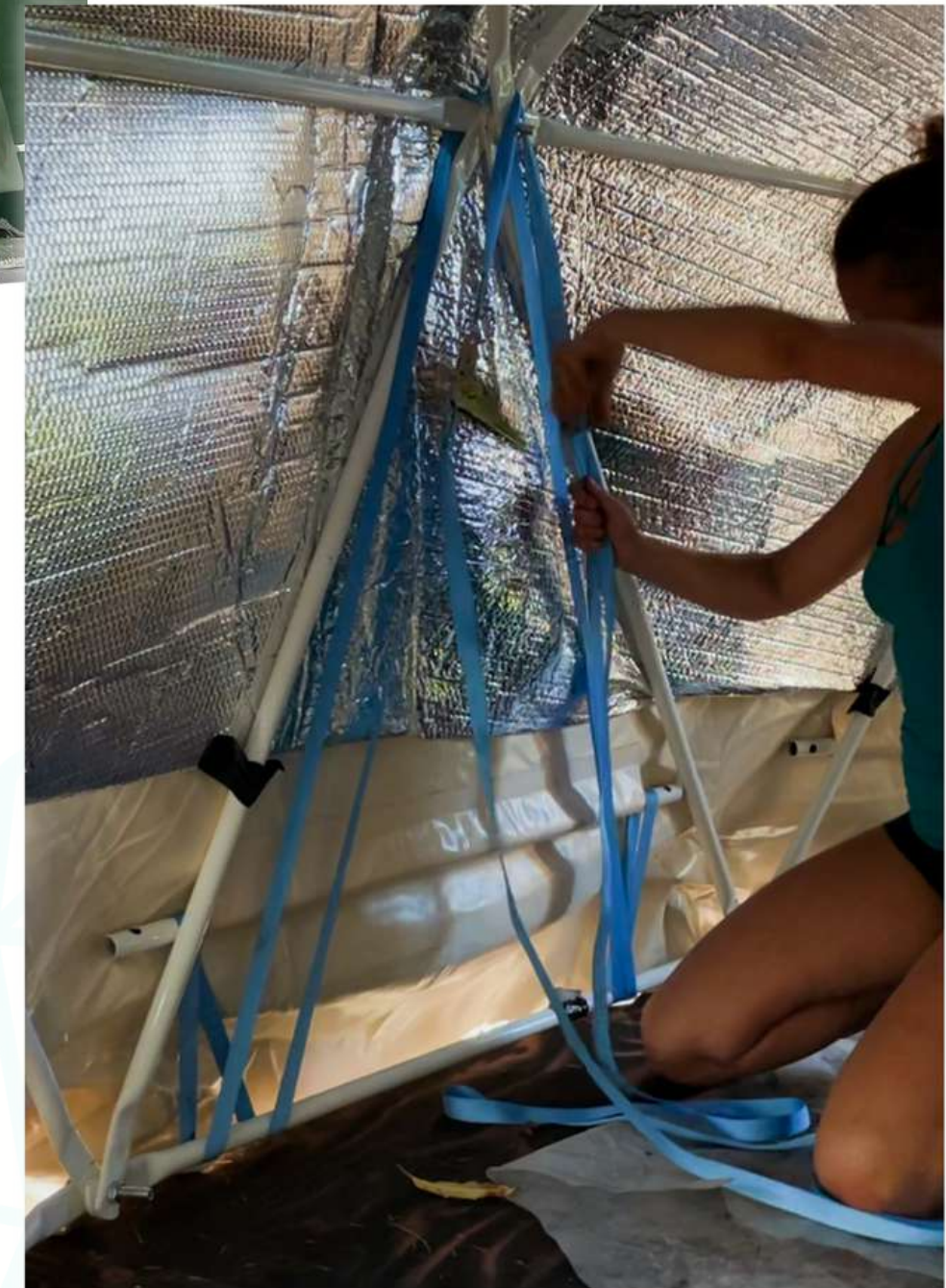
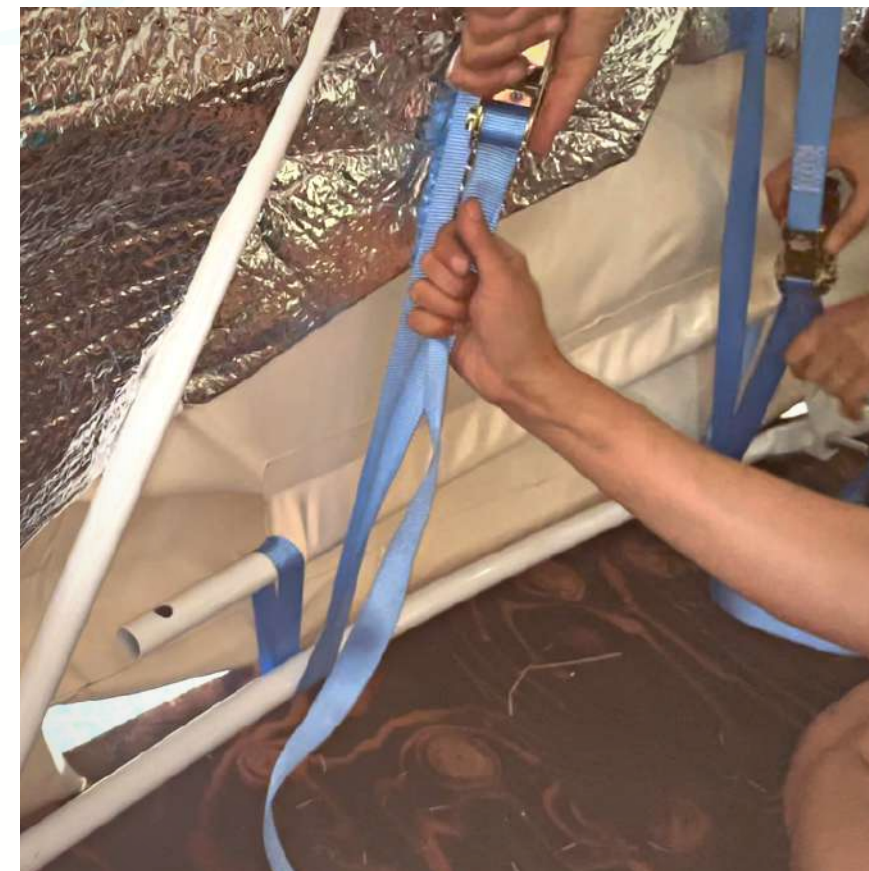

D) Continue All the Way Around

- Repeating the ratchet strap technique, ratchet and tension down one tension tube after another, alternating between either side of the door for at least the first several and ultimately continuing all the way around your Dome's perimeter
- Some tension bars will require 1 ratchet strap, others will require 2 to bring down into range of the J-hooks
- The last tension tubes by the panorama window will be the 2 vertical tubes that were temporarily holding your cover in place around the door frame. Release these and use them now
- Only once all J-hooks are in place, tighten down the nuts with the 17mm socket and impact driver



B) Tensioning Your Panorama Window

- Our Domes include tension sleeves along certain sections of the pano window
- Slide the remaining shorter tension tubes inside the tensioning sleeves on the side and top of the panorama window.
- Start by using ratchet straps to pull the tension tubes close enough to the perimeter struts framing the panorama window that you can screw nuts onto J-hooks as before
 - Tighten each one down with your impact driver
- Beyond just J-hooks, we've found that heavy-duty zap straps will provide the closest possible fit
 - The closer the fit, the more the tension on the zipper will be minimized!
 - If you'd like to go one step further, your alternative is to ratchet the tension tubes until they're sitting right up against the window struts, and use thick ratchet straps to hold them there, rather than J-hooks, for the closest possible fit
 - This step can also be performed later on after weeks or months, which can allow the cover time to stretch slightly
 - If you expect to be frequently opening and closing your panorama window in the summer months, it is important to tension tightly around the window to relieve any and all pressure on the zipper and protect its health.
- Allow at least a week for the cover and pano window to stretch and settle, or longer in cold weather, before attempting to open your panorama window
- Only open your pano window as much as necessary!
 - When you do, **MAKE SURE TO RELEASE THE TENSION AT THE BASE ROW FIRST**, while still leaving the tension in place around the window's upper perimeter
 - **NEVER** force the zipper to open or close while under tension
 - If you do, your zipper **WILL** break!



7. Window Installation

Unless you have followed the previous window installation procedure, Now is the time to install your windows.

1. Window with ears

- from the inside, lift your window into the desired triangle (you can choose 2 out of 3 possible locations) and attach the ears with an additional nut on each hub.

1. Window with triangle mouting stand

8. Reflective Insulation and Oxford Interior Liner

Modular, washable, geometric



A) Layering Your Liner

- Start by familiarizing yourself with your Interior Oxford Fabric Liner Installation Diagram (available on our [Resources page](#), it will vary depending on the size of your Dome) in terms of which shapes will go where
- If the reflective insulation is separate from the fabric, install it first, then the fabric over top, according to the same pattern. The insulation does not have grommets or holes, for a smooth fit poke a hole in the center first and attach it, then poke holes for the other bolts after smoothing the piece. It is not necessary to tape the insulation pieces together, as it will reflect heat just the same while breathing and letting any potential moisture escape from the cavity.
- Begin with the lowest pieces and work your way up, securing each in place with a white acorn cap
 - For the most pleasing final effect, we recommend overlapping higher fabric pieces on top of lower ones
 - You will have enough plastic clips included to apply two to each strut outlining your pano window, skylight, and triangle window vents
 - We'll take care of the window vents on the next page

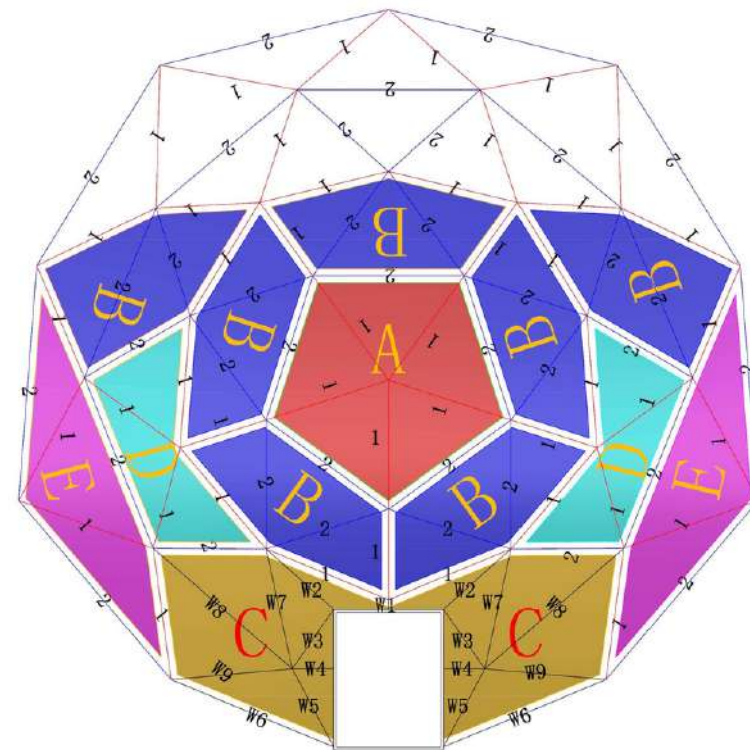

5M 2V Dome
Interior Oxford Liner Diagram

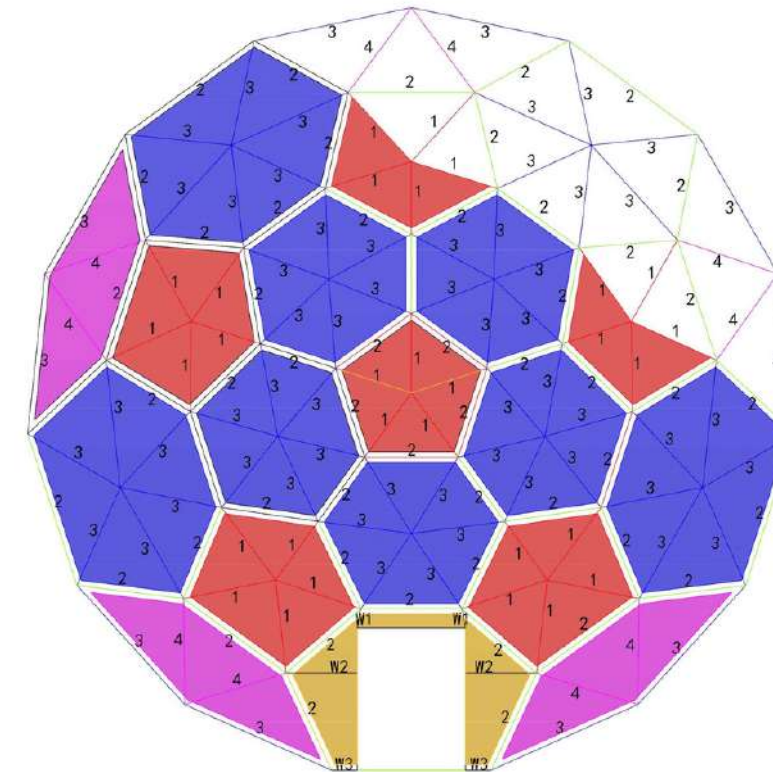

6, 7, 8M 3V Dome
Interior Oxford Liner Diagram

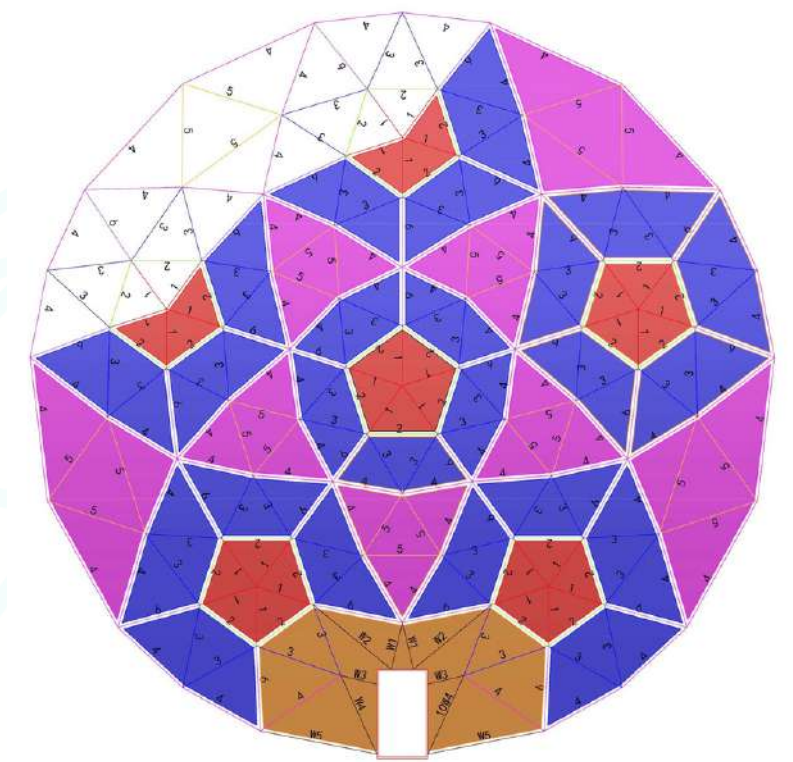

9M 4V Dome
Interior Oxford Liner Diagram

Window Vent Finishing - Glass Window

- The 2-in-1 liner/insulation has a flap for the window sewn into the piece. No other action is required.
- For the 2-piece liner/insulation, install it first, then feel for the window.
- Screw the inner trim to the window frame with self-tapping screws
- Below right is what the Oxford liner over the window should look like just prior to cutting it out with your knife, after you've already screwed each of the three finishing strips into place
- This photo shows an older single-piece triangular finishing bracket, however our newer finishing strips are 3 separate pieces with angled ends that together create a triangle
 - This older bracket is white, however our newer finishing strips arrive in silver. You can paint it in any colour that matches your decor before installation, if desired.
- Once your Oxford liner is pinned in place, then you can cut it out exactly to the inside edge of the finishing strips
- Refer to the Triangle Glass Window Instructions on our Resources page for complete information



Light and Medium Frame
Strut Clips



Heavy Frame
Strut Clips



9. Curtain Kit Installation

It's starting to look pretty cozy in here!

Bracketless installation - follow this if you don't have any curtain brackets, just the clips:

- With a helper or two, hold up the curtain track in the desired position and mark where it crosses the struts.
- Clip the mounting clips onto the track.
- Using self-tapping screws, screw the curtain clips directly into the metal dome frame struts



Installation with brackets:



- Consider the hubs of your Dome above and lateral to the top of your panorama window, imagining your curtain track as eventually parallel as shown
- Short bracket struts will be added where the distance from hubs to curtain tracks is shorter, longer ones where the distance is longer
 - 2V Domes will include 5 bracket struts
 - 3V Domes, shown above, will include 6 bracket struts
 - 4V Domes will include 7 bracket struts
- Remove the white plastic acorn caps from these hubs, and slide correctly sized bracket struts onto these hubs using an extra nut (from your Dome's hardware bag) and your impact driver to hold them in place
- You'll want to tighten them all the way down and reattach your acorn caps later on after the curtain track is up and mounted

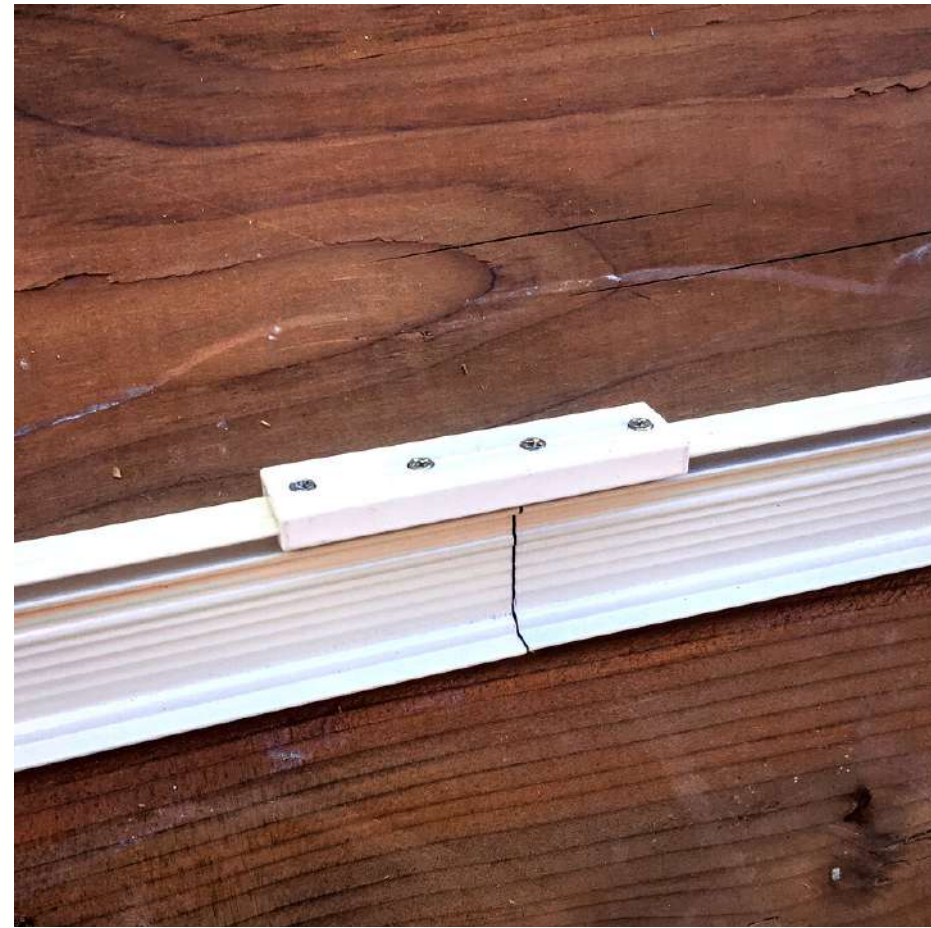

- Attach your curtain track together with the joiner brackets



- Slide on each of the curtain sliders



- Screw on each of the end stops



- Then, with the help of a partner, clip the curtain track into each of the 6 bracket struts by tilting it into their plastic teeth and pushing it up until it clicks into place
 - Be gentle with the clips! They can be finicky
 - our newest version has steel clips that need to be slid onto the track from the sides, before installing the brackets.

- Slide the curtain hooks into the pockets of the curtain, leaving **4 pockets empty** in between each curtain hook

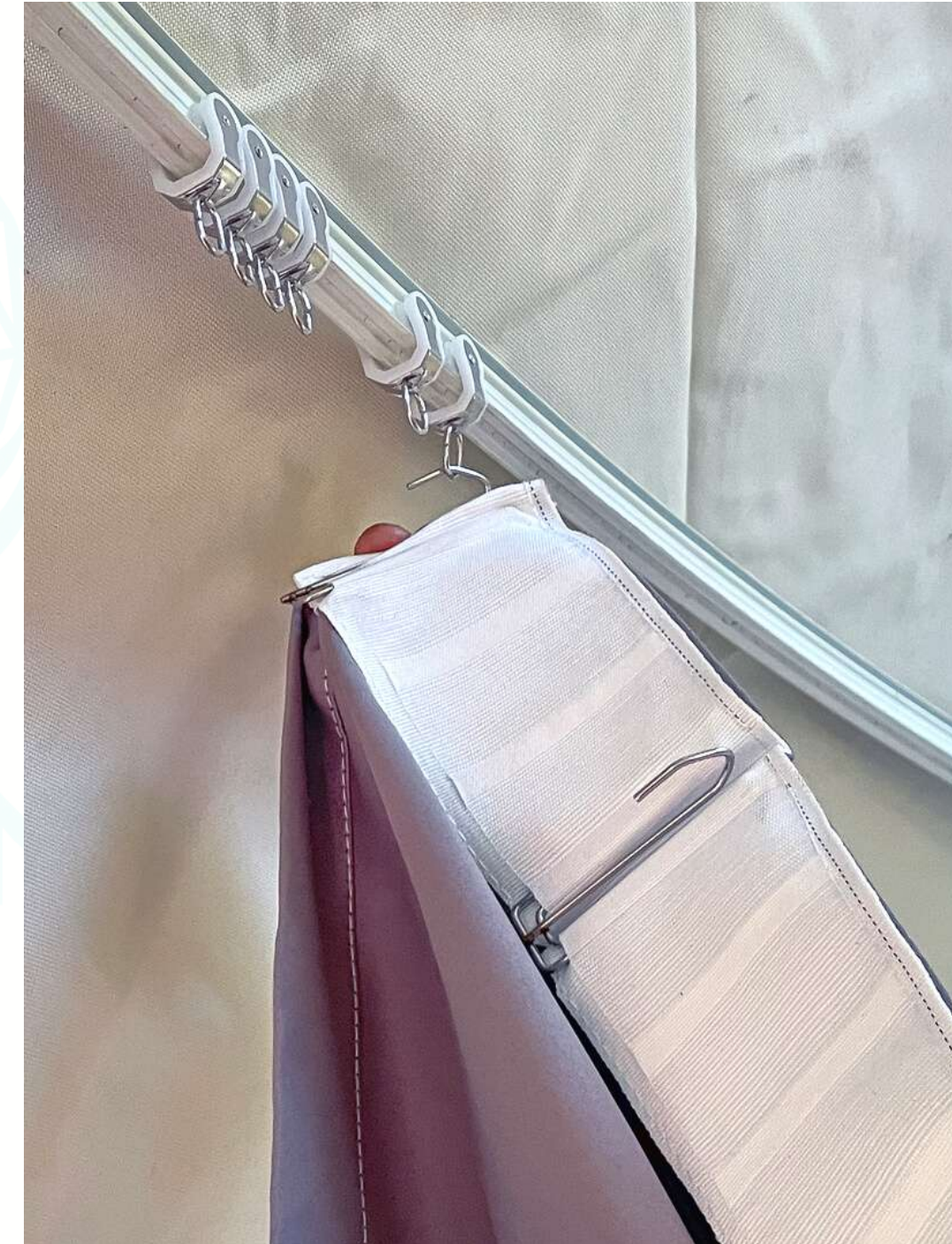
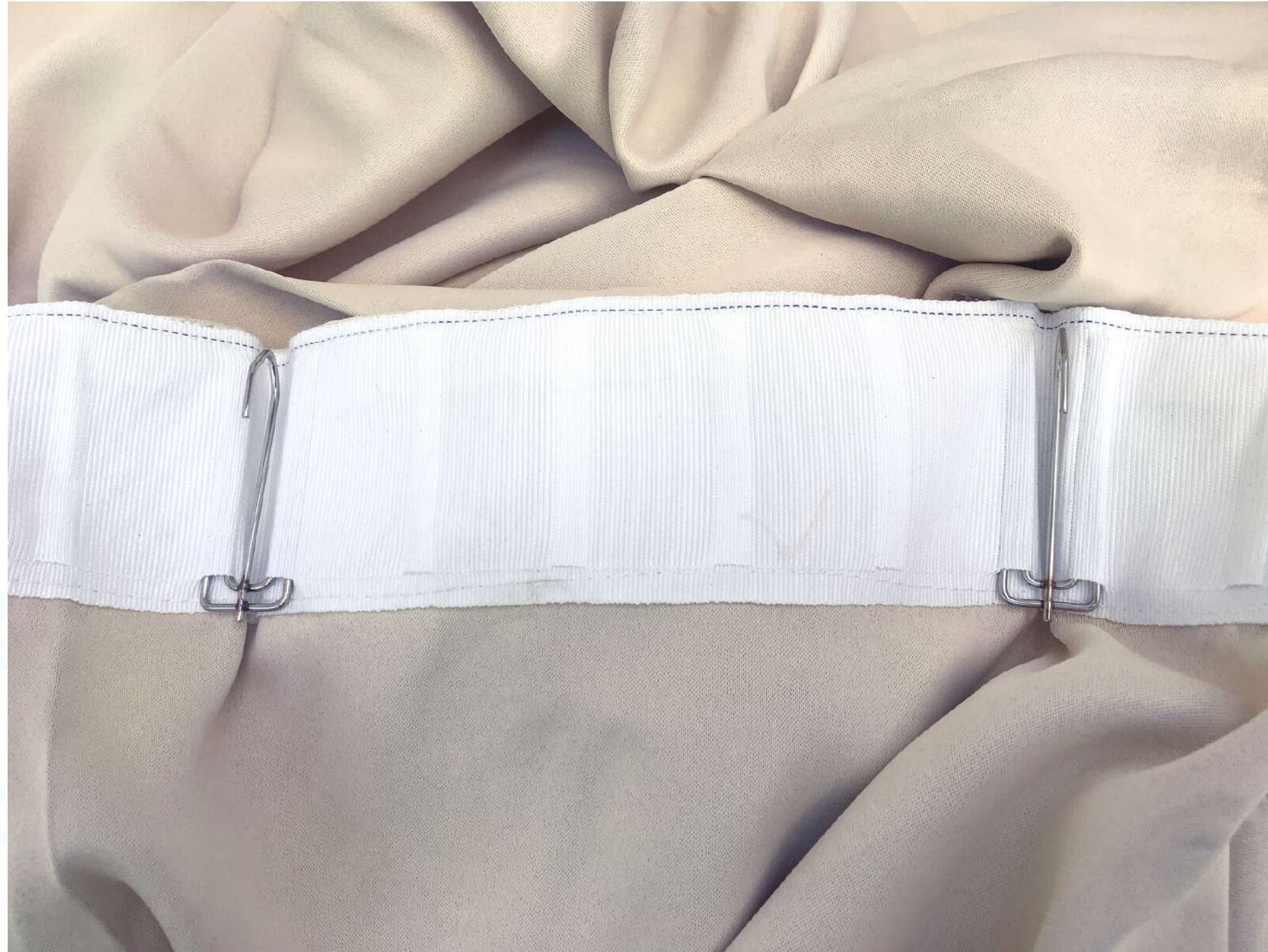

- Lastly, hang up your curtain by sliding the hooks through the loops of the rollers

10. Exterior Finishing

It's all up to you from here on out!

A) Installing Your Door

- Use shims as necessary to make sure your pre-hung door is level and opens and closes easily, then screw it into its final position. You will need to pre-drill some holes into the metal fram. **Handyman assistance can be a good idea if you haven't done this before!**
- Pull the outer cover towards the door, staple it to the door jamb, and trim off the excess
- Sandwich the cover with trim of your choice for a nice clean finish around the door
- Do the same on the inside for the Oxford liner, securing it to the outer frame with staples or similar, followed by trim if desired
- Caulk underneath the door and any other potential locations around the base of the Dome where rainwater might pool and attempt to run in, as well as the upper edge of your doorway trim and potentially its sides
- We've found that Titebond Weathermaster sealant does an excellent job of adhering to both the cover vinyl of the Dome as well as most other common building materials, which you can find locally in many hardware stores or order from us via our website





B) Awning Options

- If desired, you may extend the included mini-awning and build an additional covered space
- Extra cover material and glue are available for purchase if needed
 - Get in touch with us at contact@phoenixdomes.com if you'd like some!

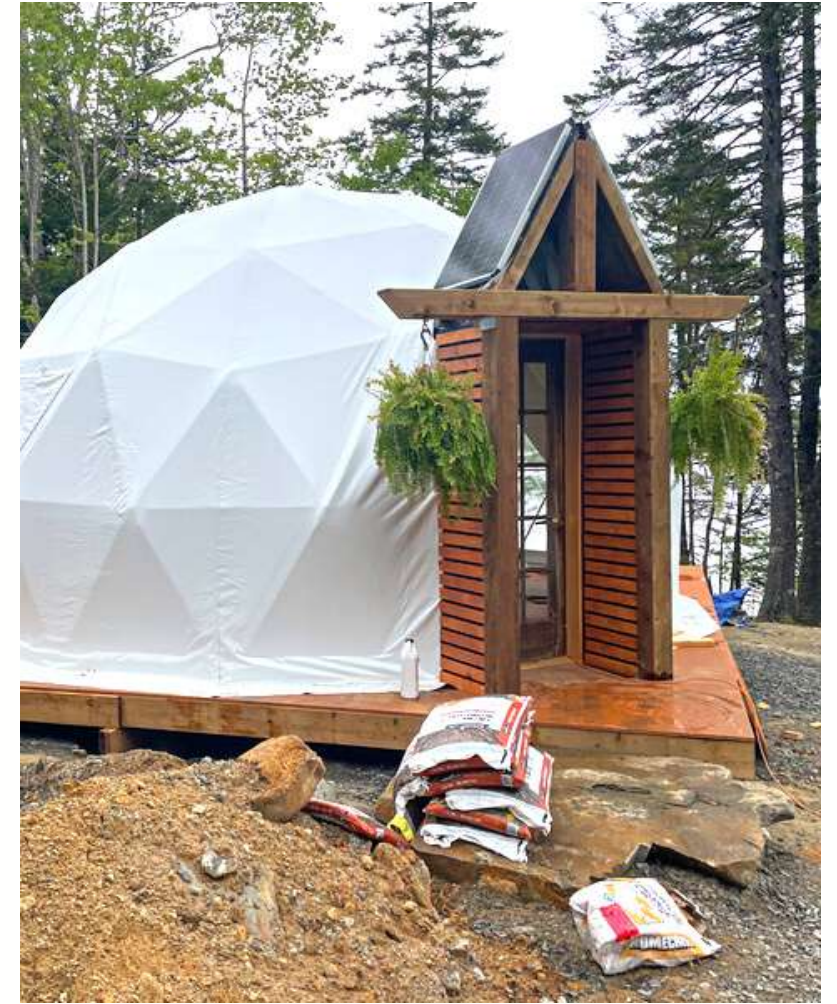

C) Sealing Around the Base

- In order to create a weathertight seal around the edge of your Dome, staple the bottom edge of the dome skirt to the platform, pulling it tight
- This will be perfectly sufficient as far as functionality is concerned, however you can also add trim all around as an upgrade if you like
 - Cedar, PVC, or aluminum will all work nicely
 - One easy option is a flexible 4" roll-type trim called 'Shur Trim Vinyl Wall Base' in white, black, grey, and beige which you can find at Home Depot. This kind of trim can also be used around on the inside of the Dome to create a nice seal around the edge and prevent dirt from creeping underneath if you like!



D) Utilities and Add-Ons

- Now is the time to run water, power, and HVAC into your Dome
 - We have silicone flashing kits available on our website in various sizes to waterproof any roof or wall penetrations
- You'll also want to install any of our add-ons, such as solar fans, chimney flashings, infrared heaters, or hanging chairs
- Get in touch with us if you plan to get the inside of your Dome insulated with spray foam, as this can change the order of certain steps above



11. Dome Care & Repairs

Be sure to look after your new family member!

You can use a sponge with soap, or ideally a pressure washer to remove debris and algae from the cover of your Dome. We recommend a good pressure washing once each year to keep your cover looking clean and fresh



Your Dome cover's lifespan is at least 10 years, and likely longer depending on its location and UV exposure. We can provide replacement covers whenever necessary! The frame of your Dome will last indefinitely as long as it is not exposed to excess moisture or salty air

Any cuts, holes or leaks can be easily remedied with a patch kit, available on our website, which includes vinyl cement glue and additional material. Your first patch kit comes free, just ask! In an emergency, use sheathing or tuck tape until your patch kit arrives. Titebond Weathermaster is a good option for small leaks or winter repairs.

At times you may notice soot streaks from your chimney that are difficult to clean. Soap and bleach are both worth a try, but we've found that WD-40 works best!

To maintain clear visibility through your windows, make sure to only use non-abrasive rags or sponges with soap or window cleaner

If you've ordered a Dome that includes our interior Oxford fabric liner, bear in mind that it's designed to be modular and easily machine washable whenever necessary in any conventional washer/dryer 2-4 pieces at a time!

12. Disclaimers and Info

That's all, folks!

A) Panorama Window Disclaimer

The panorama window is a clear vinyl that is strong, UV resistant, and won't yellow. However, it will have some wrinkles and unevennesses that will smooth out over time with sun exposure, but may not completely disappear. Your view may be somewhat blurry, but still beautiful and bright. This is normal and to be expected for the low cost compared to glass or polycarbonate

Zip-off panorama windows come standard with our glamping package Domes so that nobody will suffocate in the summer without air conditioning! Please make sure to treat your zipper with caution and great care. Even though we source the highest quality YKK zippers, they can still break if handled with force or under tension

- When tensioning the cover during installation, you can tension the bottom of the panorama window with the zipper fully closed in order to get the cover to settle and wrinkles to come out. This usually takes a few weeks to a few months depending on the climate and season. However, do not tighten the Dome to the point of extreme tension as this could cause the zipper to break
- If opening/closing the zipper, make sure to release all tensioning hooks below the panorama window first, while having the tensioning pipes around the window edge cinched tightly.
- When closing the zipper, make sure to pull both sides together and support the window piece so that there is no additional tension on the zipper whatsoever
- Only open and close the zipper when necessary for temperature control – it is not meant to be used daily
- Please note that we do not warranty the zipper for any issues due to incorrect use or overuse
- The zipper can be opened partially while keeping the bulk of the window attached for more regular use, but be sure to still treat it with great care
- On 7m and larger Domes, you can open just the side of the zipper and remove the horizontal strut in the opening for the summer, so that you can have an extra door to go out onto a deck! Make sure to put it back for winter to maintain the structural integrity of the Dome for the sake of snow load



B) Affiliate Program

- We are offering each of our existing customers who have purchased a Dome a 5% affiliate commission on referrals. This way you can make some money showing off your Dome(s) and talking it up to your friends, family and customers!
- There are a few guidelines that apply:
 - The customer must not have previously contacted or been contacted by Phoenix Domes
 - The customer or affiliate must let us know that there is a referral in place at the start of the sales conversation (before first estimate is sent) - so if you have talked to someone who might be interested in a Dome, just send us a note letting us know their name, and ask them to mention that they have been referred by you when they reach out to us. You can also copy Phoenix Domes and the potential customer in an introductory email, which is usually simplest!
 - Once the sale has closed, we will need you to invoice us for the commission payout to keep it clear for the books. If you do not have your own invoice template, we can send you one to fill out
 - We will pay out the commission within no more than 14 days of closing the referred sale
- If you are showing your Domes(s) to a customer who was already in contact with Phoenix Domes and wanted to see a Dome in person before making a decision, we are offering a commission for doing so at the value of a single night Airbnb rental of your Dome, if they decide to buy after viewing it
 - If you do not rent your Dome, we will offer you the equivalent of what the average nightly rental rate would be for a Dome of that size and setup in your area (usually, these range from \$150-350 though it can be more for super luxury Domes)

C) Warranty Information

- We offer a 5 year warranty against UV damage, manufacturer defects, and premature deterioration of our Dome covers. During this time period, if any seams split or open up by themselves, we will happily provide you with a complimentary patch kit via expedited shipping
- If the cover is compromised and not easily repairable, we will provide a replacement



A BUDDING DOME VILLAGE ON THE QUISIBIS RIVER

Bruno and Roxanne in NB have three Domes up and running, and they're not slowing down anytime soon. With three more on the way and due to start construction in June 2022, their wilderness glamping experiences will doubtless refresh and reconnect hundreds of visitors this year alone.



"The biggest benefits have to be our clients' comments after living the experience. They want to come back, they want to tell everyone how much they enjoyed the experience, how relaxing it was, & that everyone should do it! It's the best reward for us & the best publicity for the business."

[Click Here for Full Testimonial](#)

D) Photos & Testimonials

- We would absolutely love to see photos of your Dome once it's up and finished!
 - If you're willing to share a few shots of your masterpiece, please reach out via contact@phoenixdomes.com
- If you'll be using your Dome for any kind of commercial venture, we'd love to partner with you!
 - This would include anyone getting into glamping, geodesic farming, studios of various kinds, etc
 - If you're able to fill out our testimonial survey and include a bit of photo/video, we'd be happy to promote your growing business via our social media, monthly newsletter, [Testimonials page](#), and the regularly updated list of successful commercial ventures on our [Why Phoenix](#) page
 - This entails multiple posts about you over time, as well as multiple permanent hyperlinks to your website, which boosts your searchability rankings on Google!
 - Of course, any testimonial from someone who's stoked on their Dome, regardless of business or personal use, is very much appreciated!
- **[You can find our Phoenix Experience testimonial survey here!](#)**

THANKS SO MUCH FOR CHOOSING PHOENIX :)

Please don't hesitate to reach out if you have questions or feedback.

We're here to help anytime!



PHOENIX DOMES