

CDi Series Operation Manual

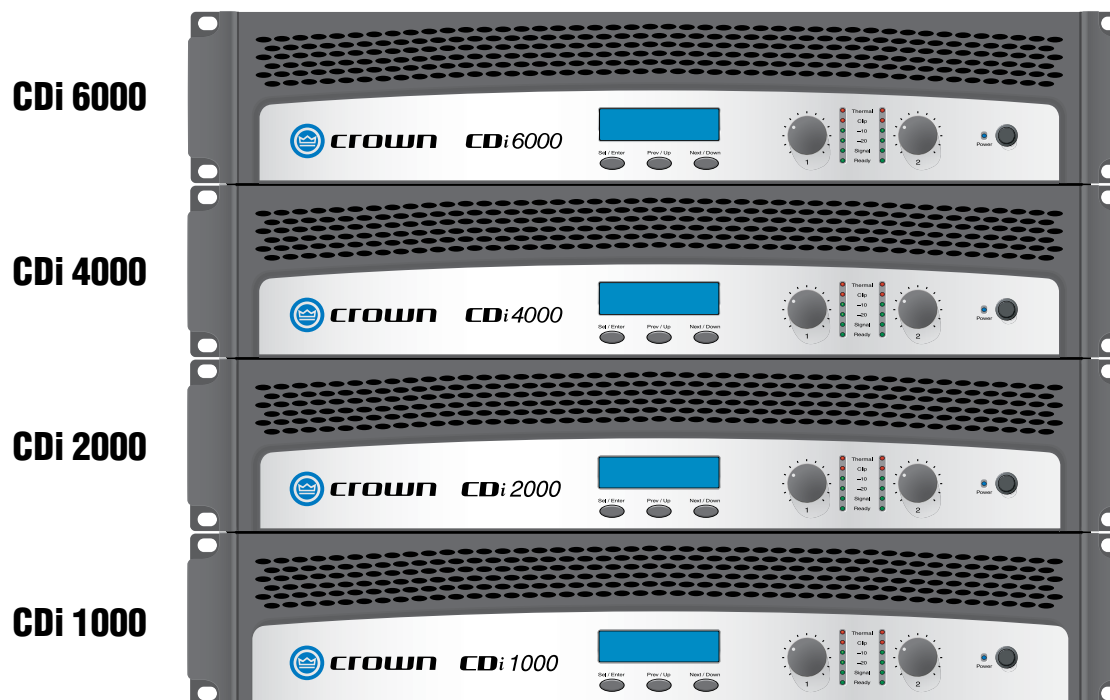

Obtaining Other Language Versions: To obtain information in another language about the use of this product, please contact your local Crown Distributor. If you need assistance locating your local distributor, please contact Crown at 574-294-8000.

This manual does not include all of the details of design, production, or variations of the equipment. Nor does it cover every possible situation which may arise during installation, operation or maintenance.

The information provided in this manual was deemed accurate as of the publication date. However, updates to this information may have occurred. To obtain the latest version of this manual, please visit the Crown website at www.crownaudio.com.

Trademark Notice: Crown, Crown Audio and Amcron are registered trademarks of Crown International. Other trademarks are the property of their respective owners.

Some models may be exported under the name Amcron®.

Important Safety Instructions

Importantes Instrucciones de Seguridad

1. Read these instructions.
2. Keep these instructions.
3. Heed all warnings.
4. Follow all instructions.
5. Do not use this apparatus near water.
6. Clean only with a dry cloth.
7. Do not block any ventilation openings. Install in accordance with the manufacturer's instructions.
8. Do not install near any heat sources such as radiators, heat registers, stoves, or other apparatus (including amplifiers) that produce heat.
9. Do not defeat the safety purpose of the polarized or grounding-type plug. A polarized plug has two blades with one wider than the other. A grounding-type plug has two blades and a third grounding prong. The wide blade or the third prong is provided for your safety. If the provided plug does not fit into your outlet, consult an electrician for replacement of the obsolete outlet.
10. Protect the power cord from being walked on or pinched, particularly at plugs, convenience receptacles, and the point where they exit from the apparatus.
11. Only use attachments/accessories specified by the manufacturer.
12. Use only with a cart, stand, tripod, bracket, or table specified by the manufacturer, or sold with the apparatus. When a cart is used, use caution when moving the cart/apparatus combination to avoid injury from tip-over.
13. Unplug this apparatus during lightning storms or when unused for long periods of time.
14. Refer all servicing to qualified service personnel. Servicing is required when the apparatus has been damaged in any way, such as power-supply cord or plug is damaged, liquid has been spilled or objects have fallen into the apparatus, the apparatus has been exposed to rain or moisture, does not operate normally, or has been dropped.
15. Use the mains plug to disconnect the apparatus from the mains.
16. WARNING: TO REDUCE THE RISK OF FIRE OR ELECTRIC SHOCK, DO NOT EXPOSE THIS APPARATUS TO RAIN OR MOISTURE.
17. DO NOT EXPOSE THIS EQUIPMENT TO DRIPPING OR SPASHING AND ENSURE THAT NO OBJECTS FILLED WITH LIQUIDS, SUCH AS VASES, ARE PLACED ON THE EQUIPMENT.
18. THE MAINS PLUG OF THE POWER SUPPLY CORD SHALL REMAIN READILY OPERABLE.



Wichtige Sicherheitsinstruktionen

Instrucciones de Seguridad Importantes

TO PREVENT ELECTRIC SHOCK DO NOT REMOVE TOP OR BOTTOM COVERS. NO USER SERVICEABLE PARTS INSIDE. REFER SERVICING TO QUALIFIED SERVICE PERSONNEL.

À PRÉVENIR LE CHOC ÉLECTRIQUE N'ENLEVEZ PAS LES COUVERCLES. IL N'Y A PAS DES PARTIES SERVICEABLE À L'INTÉRIEUR. TOUS REPARATIONS DOIT ÊTRE FAIRE PAR PERSONNEL QUALIFIÉ SEULMENT.

PARA PREVENIR UN CHOQUE ELÉCTRICO, NO RETIRE LAS CUBIERTAS SUPERIOR O INFERIOR. NO EXISTEN PARTES QUE PUEDAN SER REPARADAS POR EL USUARIO AL INTERIOR. REMITA EL SERVICIO AL PERSONAL TÉCNICO CALIFICADO.

TO COMPLETELY DISCONNECT THIS EQUIPMENT FROM THE AC MAINS, DISCONNECT THE POWER SUPPLY CORD PLUG FROM THE AC RECEPTACLE. THE MAINS PLUG OF THE POWER SUPPLY CORD SHALL REMAIN READILY OPERABLE.

POUR DÉMONTER COMPLÈTEMENT L'ÉQUIPEMENT DE L'ALIMENTATION GÉNÉRALE, DÉMONTER LE CÂBLE D'ALIMENTATION DE SON RÉCEPTACLE. LA PRISE D'ALIMENTATION RESTERA AISÉMENT FONCTIONNELLE.

PARA DESCONECTAR COMPLETAMENTE EL EQUIPO DEL SUMINISTRO ELÉCTRICO, DESCONECTE EL CABLE DE ALIMENTACION DE LA TOMA DE CA. LAS PATAS DEL CONECTOR DEL CABLE DE ALIMENTACIÓN DEBERAN MANTENERSE EN BUEN ESTADO.

WATCH FOR THESE SYMBOLS:

The lightning bolt triangle is used to alert the user to the risk of electric shock.

The exclamation point triangle is used to alert the user to important operating or maintenance instructions.

REGARDEZ CES SYMBOLES:

La triangle avec le sigle "foudre" est employée pour alerter l'utilisateur au risque de décharge électrique. Le triangle avec un point d'exclamation est employée pour alerter l'utilisateur d'instruction importantes pour lors opérations de maintenance.

ATENCIÓN CON ESTOS SÍMBOLOS:

El triángulo con el símbolo de rayo eléctrico es usado para alertar al usuario de el riesgo de un choque eléctrico.

El triángulo con el signo de admiración es usado para alertar al usuario de instrucciones importantes de operación o mantenimiento.



IMPORTANT

CDi Series amplifiers require Class 2 output wiring.

Les amplificateurs de série de CDi exigent des câbles de sortie de classe 2.

CDi-Reihe-Verstärker verlangen Klasse die 2 Produktionsverdrahtung. Los amplificadores de la Serie CDi requieren de un cableado de salida Clase 2.

MAGNETIC FIELD

CAUTION! Do not locate sensitive high-gain equipment such as pre-amplifiers directly above or below the unit. Because this amplifier has a high power density, it has a strong magnetic field which can induce hum into unshielded devices that are located nearby. The field is strongest just above and below the unit.

If an equipment rack is used, we recommend locating the amplifier(s) in the bottom of the rack and the preamplifier or other sensitive equipment at the top.



CAUTION
RISK OF ELECTRIC SHOCK
DO NOT OPEN

AVIS
RISQUE DE CHOC ÉLECTRIQUE
N'OUVREZ PAS

FCC COMPLIANCE NOTICE

This device complies with part 15 of the FCC rules. Operation is subject to the following two conditions: (1) This device may not cause harmful interference, and (2) this device must accept any interference received, including interference that may cause undesired operation.

CAUTION: Changes or modifications not expressly approved by the party responsible for compliance could void the user's authority to operate the equipment.

NOTE: This equipment has been tested and found to comply with the limits for a Class B digital device, pursuant to part 15 of the FCC Rules. These limits are designed to provide reasonable protection against harmful interference in a residential installation. This equipment generates, uses, and can radiate radio frequency energy and, if not installed and used in accordance with the instruction manual, may cause harmful interference to radio communications. However, there is no guarantee that interference will not occur in a particular installation. If this equipment does cause harmful interference to radio or television reception, which can be determined by turning the equipment off and on, the user is encouraged to try to correct the interference by one or more of the following measures:

- Reorient or relocate the receiving antenna.
- Increase the separation between the equipment and receiver.
- Connect the equipment into an outlet on a circuit different from that to which the receiver is connected.
- Consult the dealer or an experienced radio/TV technician for help.

DECLARATION of CONFORMITY

ISSUED BY: Harman International
1718 W. Mishawaka Road
Elkhart, Indiana 46517 U.S.A.

FOR COMPLIANCE QUESTIONS ONLY: Sue Whitfield
Sue.Whitfield@harman.com

European Representative's Name and Address:

David Budge
10 Harvest Close
Yateley GU46 6YS
United Kingdom

Equipment Type: Power Amplifiers

Family Name: CDi series

Model Names: CDi1000, CDi2000, CDi4000, CDi6000

EMC Standards:

EN 55103-1:2009 EMC Compatibility – Product Family Standard for Audio, Video, Audio-Visual and Entertainment Lighting Control Apparatus for Professional Use, Part 1: Emissions

EN 55103-1:2009 Magnetic Field Emissions – Annex A @ 10cm and 20cm

EN 61000-3-2:2006 Limits for Harmonic Current Emissions (equipment input current less than or equal to 16A)

EN 61000-3-3:2008 Limitation of Voltage Fluctuations and Flicker in Low-Voltage Supply systems Rated Current less than or equal to 16A

EN 55022:2010 Limits and Methods of Measurement of Radio Disturbance Characteristics of ITE: Radiated & Conducted, Class B Limits

EN 55103-2:2009 EMC Compatibility – Product Family Standard for Audio, Video, Audio-Visual and Entertainment Lighting Control Apparatus for Professional Use, Part 2: Immunity

EN 61000-4-2:2008 Ed 2.0 Electrostatic Discharge Immunity (Environment E2-Criteria B, 4k V Contact, 8k V Air Discharge)

EN 61000-4-3:2010 Ed 3.2 Radiated, Radio-Frequency, EMC Immunity (Environment E2, Criteria A)

EN 61000-4-4:2007 Electrical Fast Transient/Burst Immunity (Criteria B)

EN 61000-4-5:2006 Surge Immunity (Criteria B)

EN 61000-4-6:2006 Immunity to Conducted Disturbances Induced by Radio-Frequency Fields (Criteria A)

EN 61000-4-11:2004 Voltage Dips, Short Interruptions and Voltage Variation

Safety Standards:

IEC 60065:2001 Ed 7 +A1:2005 Safety Requirements – Audio, Video, and Similar Electronic Apparatus

CAN/CSA 60065-03 incl. A1 Safety Requirements – Audio, Video, and Similar Electronic Apparatus

UL Std No. 60065-2007 Safety Requirements – Audio, Video, and Similar Electronic Apparatus

I certify that the product identified above conforms to the requirements of the EMC Council Directive 2004/108/EC and the Low Voltage Directive 2006/95/EC.

Signed

Terry Davenport
Senior Director of Operations

Due to line current harmonics, we recommend that you contact your supply authority before connection.

Date of Issue: April 1, 2006

Table of Contents

Important Safety Instructions.....	2	3 Operation.....	11
Declaration of Conformity.....	3	3.1 Precautions.....	11
1 Welcome.....	5	3.2 Front Panel Controls and Indicators.....	11
1.1 Features.....	5	3.3 Back Panel Controls and Connectors.....	12
1.2 How to Use This Manual.....	5	4 Advanced Features and Options	14
2 Setup.....	6	4.1 Protection Systems.....	14
2.1 Unpack Your Amplifier.....	6	4.1.1 Output Current Limiting.....	14
2.2 Install Your Amplifier.....	6	4.1.2 DC Protection.....	14
2.3 Ensure Proper Cooling.....	6	4.1.3 Thermal Protection.....	14
2.4 Choose Input Wire and Connectors.....	7	4.1.4 Non-Touch Cover.....	14
2.5 Choose Output Wire and Connectors.....	7	4.1.5 Attenuator Security Covers.....	14
2.6 Wire Your System.....	8	4.1.6 DSP Presets and Processes.....	15
2.6.1 Dual Mode.....	8	5 Troubleshooting.....	18
2.6.2 Bridge-Mono Mode.....	9	6 Specifications.....	19
2.7 Connect to AC Mains.....	10	7 Service.....	20
2.8 Protecting Your Speaker.....	10	8 Warranty.....	21
2.9 Startup Procedure.....	10	Product Registration.....	23
		Crown Factory Service Information Form.....	25

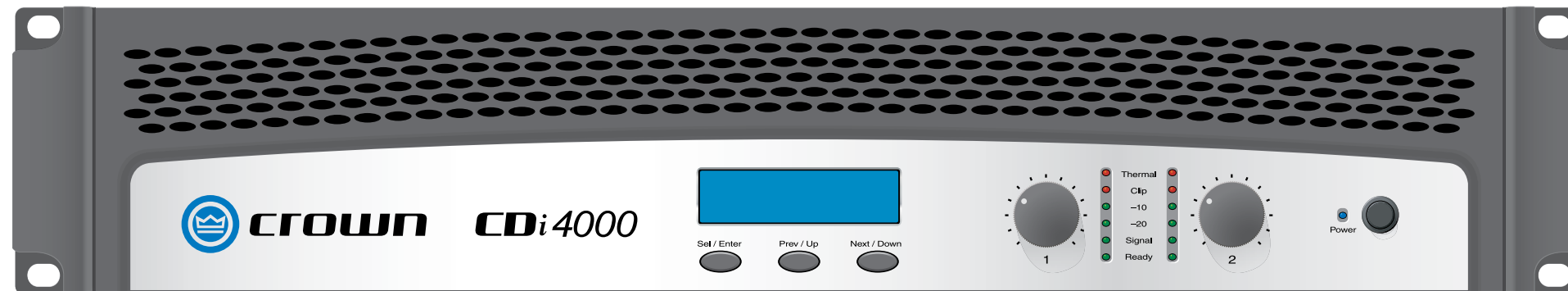

1 Welcome

The CDi Series of Crown® amplifiers are professional tools designed and built for installed sound applications. The series includes three models which are identical except for output power: CDi 1000, CDi 2000, CDi 4000 and CDi 6000. All are rugged and lightweight, and offer unmatched value in their class.

CDi-Series amplifiers feature an intuitive front-panel LCD screen to guide installers through their configurations. CDi amplifiers also offer onboard DSP for loudspeaker signal processing. Other features include a switch-mode universal power supply, useful function indicators, proportional-speed fan-assisted cooling, removable Phoenix-style inputs, barrier strip outputs for low-Z or 70V/140V loads, short-circuit protection and more.

In addition, CDi Series amplifiers include a number of features which require some explanation before they can be used to their maximum advantage.

Please take the time to study this manual so that you can obtain the best possible service from your amplifier.

1.1 Features

- Accurate, uncolored sound with very low distortion for the best in music and voice reproduction
- Advanced protection circuitry guards against: shorted outputs, open circuits, DC, mismatched loads, general overheating, high-frequency overloads and internal faults
- Extremely versatile; rated for 2, 4, 8 ohms loads and 70V and 140V outputs
- Intuitive front-panel LCD screen for quick, easy configuration
- Switch-mode universal power supply
- Onboard digital signal processing includes crossovers, EQ filters, delay, and output limiting
- All products fill 2U rack spaces and weigh under 19 pounds
- Barrier strip outputs for low-Z or 70V/140V loads, removable Phoenix-style inputs
- Three-Year, No-Fault, Fully Transferable Warranty completely protects your investment and guarantees its specifications.

1.2 How to Use This Manual

This manual provides you with the necessary information to safely and correctly setup and operate your amplifier. It does not cover every aspect of installation, setup or operation that might occur under every condition. For additional information, please consult Crown's *Amplifier Application Guide* (available online at www.crownaudio.com), Crown Technical Support, your system installer or retailer.

We strongly recommend you read all instructions, warnings and cautions contained in this manual. Also, for your protection, please send in your warranty registration card today. And save your bill of sale — it's your official proof of purchase.

2 Setup

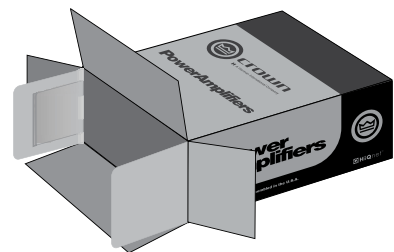

2.1 Unpack Your Amplifier

Please unpack and inspect your amplifier for any damage that may have occurred during transit. If damage is found, notify the transportation company immediately. Only you can initiate a claim for shipping damage. Crown will be happy to help as needed. Save the shipping carton as evidence of damage for the shipper's inspection.

We also recommend that you save all packing materials so you will have them if you ever need to transport the unit. **Never ship the unit without the factory pack.**

YOU WILL NEED (not supplied):

- Input wiring cables
- Output wiring cables
- Rack for mounting amplifier (or a stable surface for stacking)

WARNING: Before you start to set up your amplifier, make sure you read and observe the Important Safety Instructions found at the beginning of this manual.



2.2 Install Your Amplifier

CAUTION: Before you begin, make sure your amplifier is disconnected from the power source, with the power switch in the "off" position and all level controls turned completely down (counterclockwise).

Use a standard 19-inch (48.3 cm) equipment rack (EIA RS-310B). See Figure 2.1 for amplifier dimensions.

You may also stack amps without using a cabinet.

NOTE: When transporting, amplifiers should be supported at both front and back.

2.3 Ensure Proper Cooling

When using an equipment rack, mount units directly on top of each other. Close any open spaces in rack with blank panels. DO NOT block front or rear air vents. The back of the rack should be open.

Figure 2.2 illustrates standard amplifier airflow.

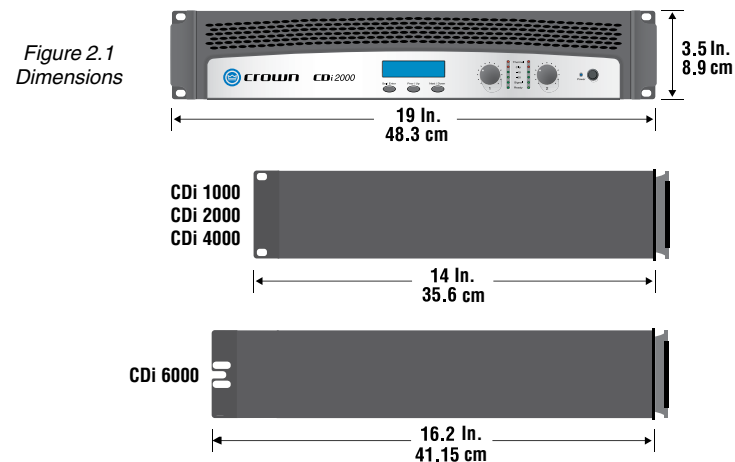

Figure 2.2 Airflow

2 Setup (continued)

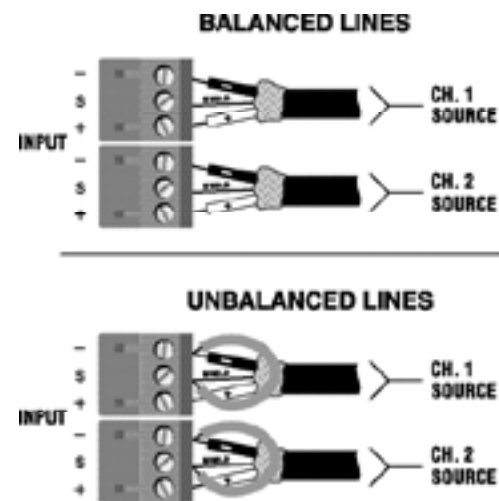

Figure 2.3 Input Connector Phoenix Wiring, Balanced (Top) and Unbalanced (Bottom)

2.4 Choose Input Wire and Connectors

Crown recommends using pre-built or professionally wired balanced line (two-conductor plus shield), 22-24 gauge cables and connectors. At the amplifier inputs, use Phoenix-style connectors (see Figure 2.3).

Unbalanced lines may be used, but may result in hum or RF noise over long cable runs.

NOTE: Custom wiring should only be performed by qualified personnel.

2.5 Choose Output Wire and Connectors

Crown recommends using pre-built or professionally wired, high-quality, two-conductor, heavy gauge speaker wire and connectors. You can use spade lugs or bare wire for your output connectors (Figure 2.4). To prevent the possibility of short-circuits, wrap or otherwise insulate exposed loudspeaker cable connectors.

Using the guidelines below, select the appropriate size of wire based on the distance from amplifier to speaker.

Distance	Wire Size
up to 25 ft.	16 AWG
26-40 ft.	14 AWG
41-60 ft.	12 AWG
61-100 ft.	10 AWG
101-150 ft.	8 AWG
151-250 ft.	6 AWG

CAUTION: Never use shielded cable for output wiring.

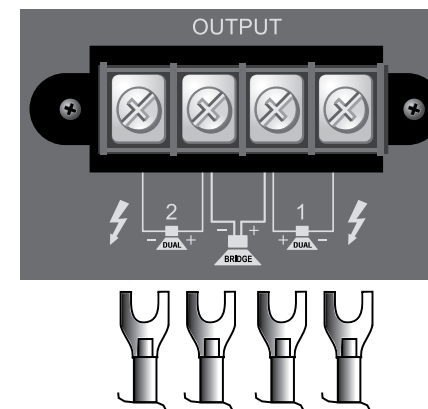

Figure 2.4 Barrier Strip Output Wiring

2 Setup (continued)

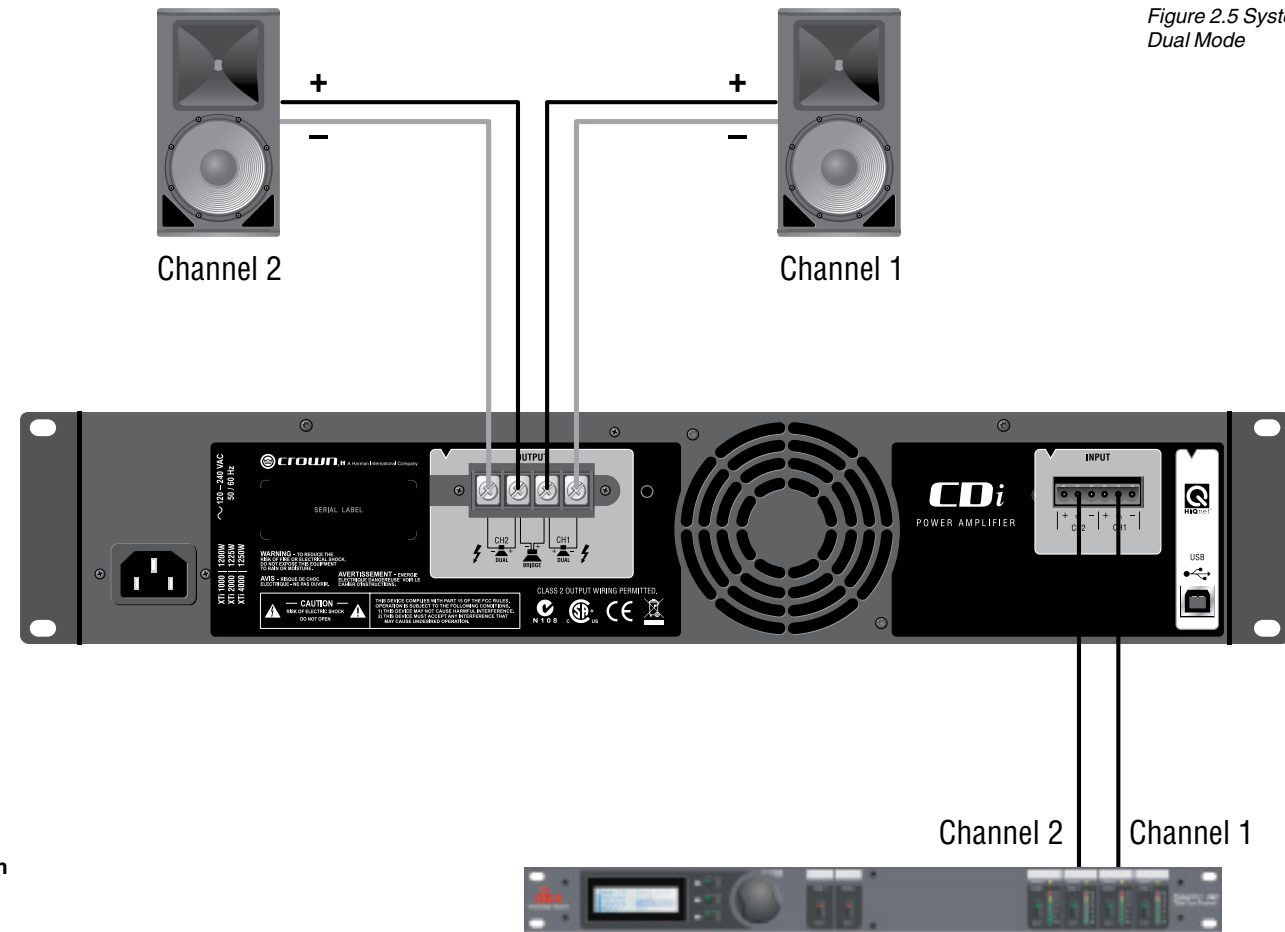

Figure 2.5 System Wiring, Dual Mode

2.6 Wire Your System

2.6.1 Dual Mode

Typical input and output wiring is shown in Figure 2.5.

INPUTS: Connect input wiring for both channels.

OUTPUTS: Maintain proper polarity (+/-) on output connectors.

Connect Channel 1 loudspeaker's positive (+) lead to Channel 1 positive (+) terminal of amp; repeat for negative (-). Repeat Channel 2 wiring as for Channel 1.

2 Setup (continued)

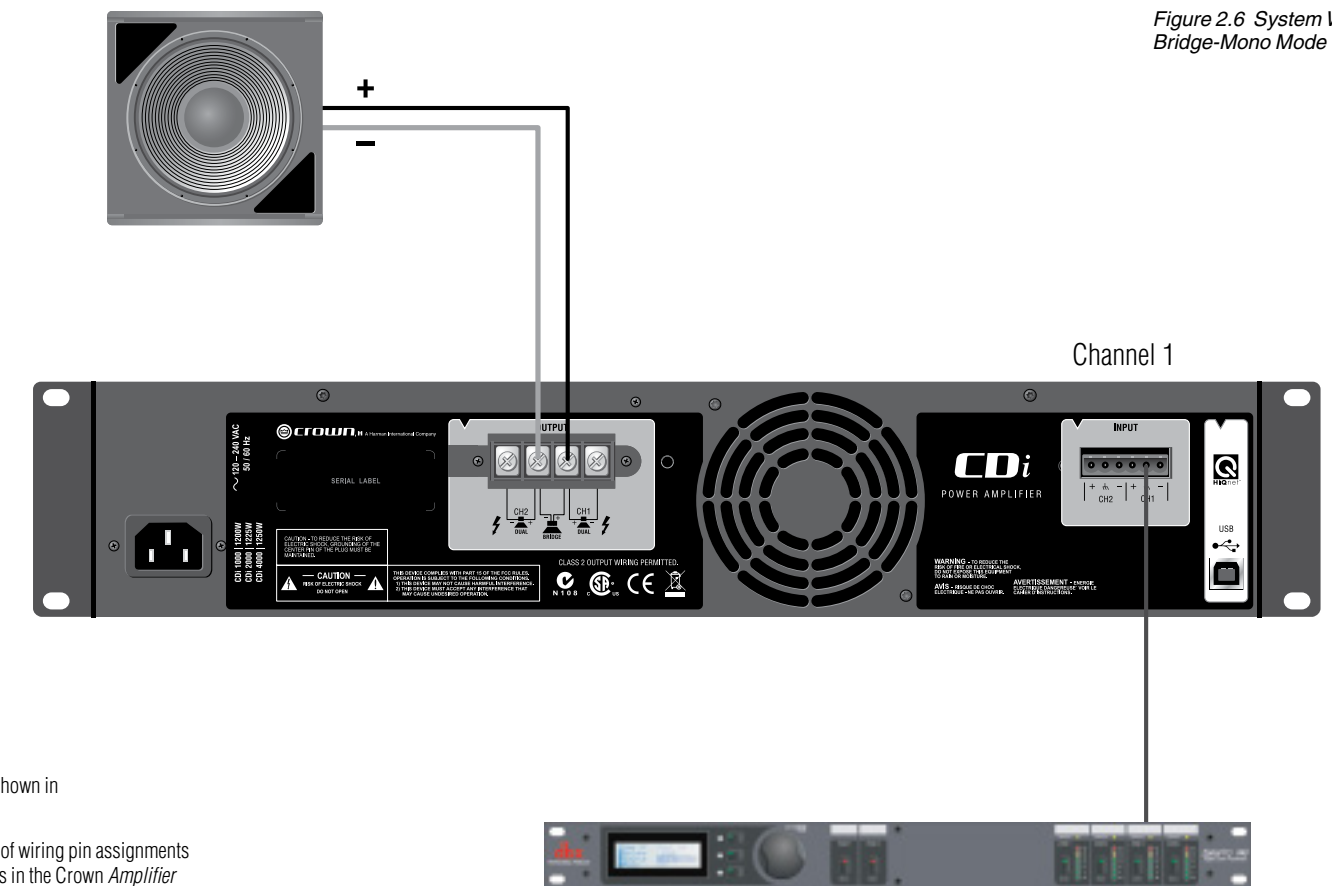

Figure 2.6 System Wiring, Bridge-Mono Mode

2.6.2 Bridge-Mono Mode

Typical input and output wiring is shown in Figure 2.6.

NOTE: Crown provides a reference of wiring pin assignments for commonly used connector types in the Crown *Amplifier Application Guide* available at www.crownaudio.com.

OUTPUTS: Connect the speaker across barrier-strip terminals 1+ and 2+.

IMPORTANT: Set the Bridge/Normal switch in the LCD screen to "Bridge." See Section 4.1.5.

NOTE: In Bridge-Mono mode, only the Channel 1 Level control is functional (unless you make an alternate selection via the "Y" menu. See Section 4.1.6.)

2 Setup (continued)

2.7 Connect to AC Mains

Connect your amplifier to the AC mains power source (power outlet) with the supplied AC power cordset. First, connect the IEC end of the cordset to the IEC connector on the amplifier; then, plug the other end of the cordset to the AC mains.

WARNING: The third prong of this connector (ground) is an important safety feature. Do not attempt to disable this ground connection by using an adapter or other methods.



Amplifiers don't create energy. The AC mains voltage and current must be sufficient to deliver the power you expect. You must operate your amplifier from an AC mains power source with not more than a 10% variation above or a 15% variation below the amplifier's specified line voltage and within the specified frequency requirements (indicated on the amplifier's back panel label). If you are unsure of the output voltage of your AC mains, please consult your electrician.

2.8 Protecting Your Speakers

It's wise to avoid clipping the amplifier signal. Not only does clipping sound bad, it can damage high-frequency drivers. The built-in clip limiter prevents clipping.

Also, avoid sending strong subsonic signals to the amplifier. High-level, low-frequency signals from breath pops or dropped microphones can blow out drivers. To prevent subsonic signals, use the amplifier's DSP to insert a highpass filter (see Section 4.1.6). Alternatively, switch in highpass filters at your mixer. Set the filter to as high a frequency as possible that does not affect your program. For example, try 35 Hz for music and 75 Hz for speech. On each mixer input channel, set the filter frequency just below the lowest fundamental frequency of that channel's instrument.

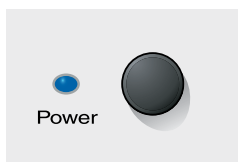

2.9 Startup Procedure

Use the following procedure when first turning on your amplifier:

1. Turn down the level of your audio source.
2. Turn down the level controls of the amplifier.
3. Turn on the "Power" switch. The Power indicator should glow.
4. Turn up the level of your audio source to an optimum level.
5. Turn up the Level controls on the amplifier until the desired loudness or power level is achieved. NOTE: In Bridge-Mono mode, only the Channel 1 Level control is functional (except for CH1 + CH2 Input Y mode).
6. Turn down the level of your audio source to its normal range.

If you ever need to make any wiring or installation changes, don't forget to disconnect the power cord.

For help with determining your system's optimum gain structure (signal levels) please refer to the Crown *Amplifier Application Guide*, available online at www.crownaudio.com.

3 Operation

3.1 Precautions

Your amplifier is protected from internal and external faults, but you should still take the following precautions for optimum performance and safety:

1. Before use, your amplifier first must be configured for proper operation, including input and output wiring hookup. Improper wiring can result in serious operating difficulties. For information on wiring and configuration, please consult the Setup section of this manual or, for advanced setup techniques, consult Crown's *Amplifier Application Guide* available online at www.crownaudio.com.

2. Use care when making connections, selecting signal sources and controlling the output level. The load you save may be your own!

3. Do not short the ground lead of an output cable to the input signal ground. This may form a ground loop and cause oscillations.

4. **WARNING: Never connect the output to a power supply, battery or power main. Electrical shock may result.**

5. Tampering with the circuitry, or making unauthorized circuit changes may be hazardous and invalidates all agency listings.

6. Do not operate the amplifier with the red Clip LEDs constantly flashing.



7. Do not overdrive the mixer, which will cause clipped signal to be sent to the amplifier. Such signals will be reproduced with extreme accuracy, and loudspeaker damage may result.

8. Do not operate the amplifier with less than the rated load impedance. Due to the amplifier's output protection, such a configuration may result in premature clipping and speaker damage.

Remember: Crown is not liable for damage that results from overdriving other system components.

9. Crown CDi amplifiers can directly drive 70V/high-Z loads. To configure your amplifier for this mode of operation, see Section 4.1.6.

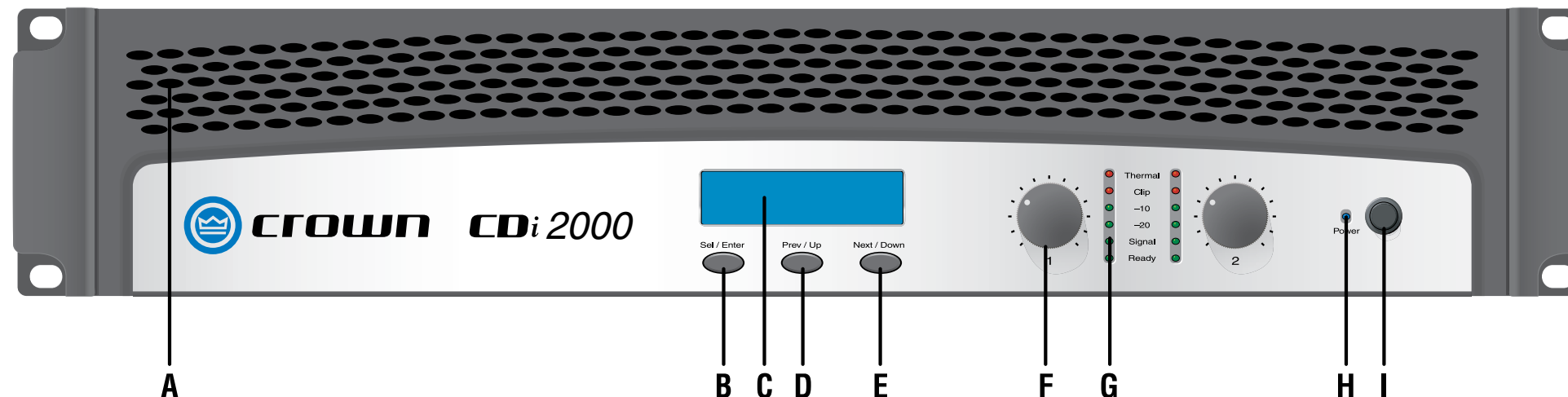

3.2 Front Panel Controls and Indicator

A. Grille

B, D, E. Sel/Prev/Next Buttons

Three buttons near the LCD screen are used to access menu items.

C. LCD Screen

Backlit liquid crystal display shows speaker presets.

F. Level

Detented rotary level control, one per channel.

H. Power Indicator

Blue LED illuminates when the amplifier has been turned on and has power.

I. Power Switch

On/off switch applies AC power to the amplifier.

G. Meter Group (one per channel)

Thermal Indicator: Red LED illuminates under excessive temperature conditions.

Clip Indicator: Red LED turns on at the threshold of audible distortion.

-10 Indicator: Green LED flashes when output signal exceeds -10 dB below clip.

-20 Indicator: Green LED flashes when output signal level exceeds -20 dB below clip.

Signal Indicator: Green LED flashes when a very low-level signal is present at input. May be used for troubleshooting cable runs.

Ready Indicator: Green LED illuminates when the amplifier is ready to produce audio.

3 Operation (continued)

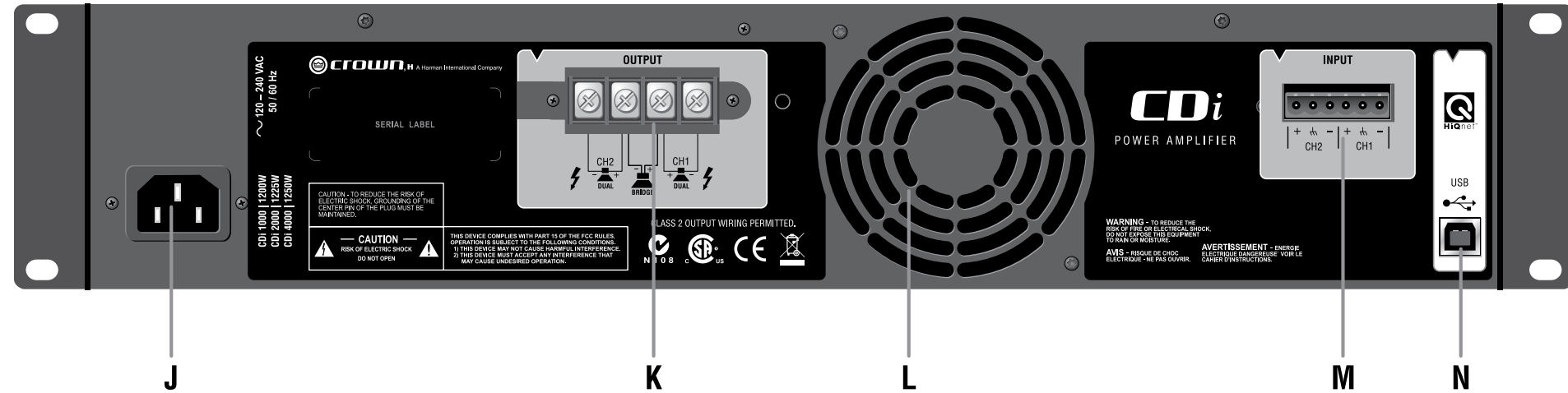

3.3 CDi 1K, 2K, 4K Back Panel Connectors

J. AC Line Connector
NEMA 5-15P (15A).

K. Output Connectors
4-position barrier strip with connectors for dual loudspeakers or bridge-mono loudspeaker. Dual connectors work with 2-8 ohm or 70V loads. Bridge-mono connectors work with 4-8 ohm or 140V loads.

L. Fan
Front-to-rear forced airflow.

M. Input Connector
Two 3-pin removable Phoenix-type connectors each accept a balanced line-level input signal.

N. HiQnet USB Connector
Type B, connects to a USB port on a PC.

3 Operation (continued)

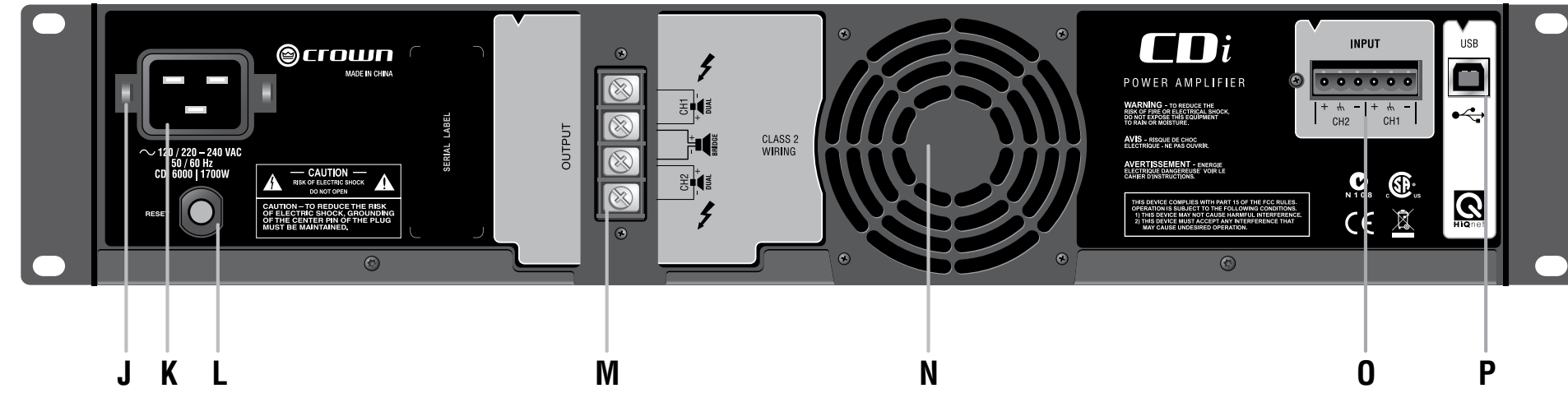

3.3 CDi 6K Back Panel Connectors

J. Line Connector Clip
Mounting points for securing power cord clip.

K. AC Line Connector
NEMA 6-20P (20A).

L. Reset Button
Resets the circuit breaker.

M. Output Connectors
4-position barrier strip with connectors for dual loudspeakers or bridge-mono loudspeaker. Dual connectors work with 2-8 ohm or 70V loads. Bridge-mono connectors work with 4-8 ohm or 140V loads.

N. Fan
Front-to-rear forced airflow.

O. Input Connector
Two 3-pin removable Phoenix-type connectors each accept a balanced line-level input signal.

P. HiQnet USB Connector
Type B, connects to a USB port on a PC.

4 Advanced Features and Options

NOTE: For detailed information about these Crown amplifier features, please consult the **Crown Amplifier Application Guide**, available on the Crown website at www.crownaudio.com.

4.1 Protection Systems

Your Crown amplifier provides extensive protection and diagnostic capabilities, including output current limiting, microprocessor-controlled DC protection, and special thermal protection for the unit's transformers and output devices.

4.1.1 Output Current Limiting

Output Current Limiting circuitry protects the amplifier output stage from damage caused by short-circuit loads.

4.1.2 DC Protection

DC Protection shuts down the amplifier in the event of an output DC offset exceeding 2V. In the majority of cases, DC protection is indicative of a faulty amplifier channel, and will be accompanied by an illuminated red Clip LED, even with no input connected and level controls set at minimum (Figure 4.1). If this is the case, contact your dealer or service center.

4.1.3 Thermal Protection

The Thermal Protection circuit will activate if the internal heatsink temperature exceeds proper operating temperatures (176°F, 80°C). When the heatsink temperature has fallen to a safe level, this protection circuit will automatically be reset. Principal causes of thermal protection are:

- 1) Inadequate ventilation of the equipment rack
- 2) Incorrect load impedance
- 3) Output cable short circuit
- 4) Blocked air vent
- 5) Heatsinks in need of cleaning
- 6) Cooling fan failure.

The cause of your amplifier's thermal protection state should be determined and corrected as soon as possible. Without correction, the Thermal Protection circuit will typically reactivate.

4.1.4 Non-Touch Cover

Located over the amplifier output terminals, this included accessory provides a shock-proof cover for the output terminals.

1. Remove the screw holding the cover onto the amplifier back panel, and remove the cover. Keep the screw.
2. The cover has two tabs A and B (Figure 4.2). Insert tab A into the slot just to the left of the output terminals (Figure 4.3).

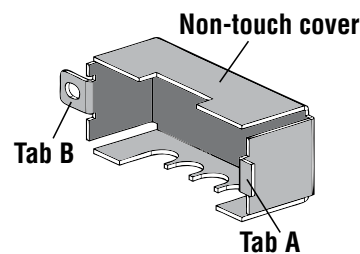

Figure 4.2 Interior of Non-Touch Cover

3. Put the screw through tab B, and screw it into the hole just to the right of the output terminals (Figure 4.3).

4.1.5 Attenuator Security Covers

The included attenuator security covers (Figure 4.4) can replace the existing level-control knobs so that the amplifier output level cannot be changed. The knobs snap into the front panel.

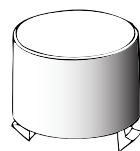

Figure 4.4 Attenuator Security Cover

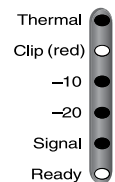

Figure 4.1 DC Protection

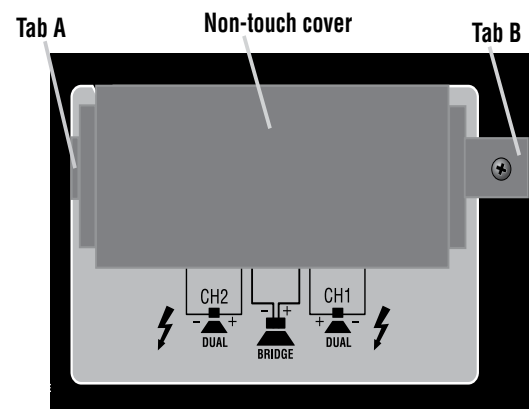

Figure 4.3 Cover Placement Over Output Terminals

4 Advanced Features and Options (continued)

4.1.6 DSP Presets and Processes OVERVIEW

Figure 4.5 shows the LCD screen and the three Menu navigation buttons: **Sel/Enter**, **Prev/Up** and **Next/Down**. These buttons let you step through the menu items displayed on the screen.

You can configure **USER PRESETS** with your own settings. When you power off and back on, your settings will be as they were when you shut off the amplifier. However, if you *recall* a user preset, all its DSP will be off—unless you had saved the preset using System Architect software (a free download from www.harmanpro.com). Any custom settings can't be saved by the front panel display, only by System Architect software.

The ICONS in the display illuminate to show which DSP functions are currently in use for each preset.

You can select the presets with the LCD screen and Menu navigation buttons.

From the front panel, you can change settings for several of the amplifier's **DSP processes**: crossovers, EQ bypass, delay, 70V mode, and output limiting. The ICONS in the display illuminate to show which DSP functions are currently applied.

When you power-on the amplifier for the first time, the LCD screen displays DSP OFF (no DSP is applied). Subsequent power-ons display the preset that was active when you shut off the amplifier.

Figure 4.6 shows the Menu Tree, which is the navigation path of options in the Menu. Later in this manual is a table that shows how to access various presets and DSP processes.

On the next page is a description of each block in the Menu Tree.

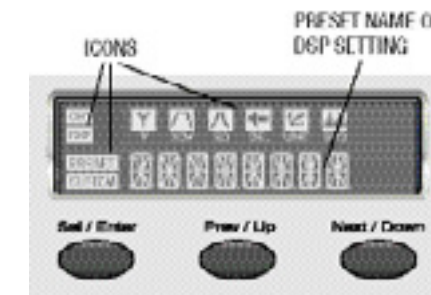

Figure 4.5 LCD Screen and Menu Navigation Buttons

Figure 4.6 Menu Tree

NAVIGATING THE LCD SCREEN MENU: BASICS

To step through the Menu options, press the **Sel**, **Next** or **Prev** buttons as described in the table later in this manual.

ICONS illuminated at the top of the screen show which DSP functions are active with the current preset.

When you are modifying a preset, its ICON flashes. You can scroll through its settings with the **Prev** and **Next** buttons. When you see the desired setting, select it by pressing **Sel**.

Doing nothing returns you to the CURRENT PRESET after ten seconds.

In the LCD screen, if the PRESET icon is lit, the current preset is unchanged from its stored settings. If the CUSTOM icon is lit, the current preset has been changed from its stored settings.

USER PRESETS: The CDi amplifier provides 19 user presets which you can modify. For example, set up a user preset with a specific crossover frequency and a specific limiting threshold.

DSP PROCESSES

The CDi amplifier includes a number of DSP processes, which appear as ICONS on the screen. They are described below:

Output Mode: The options are:

- 70V (70V/high-Z mode for Ch. 1 or Ch. 2)
- High Z – Channel is configured for 70V/high-Z loads. (A 70Hz high-pass filter is automatically enabled whenever 70V is on.) It is a 24 dB/octave Linkwitz-Riley filter in the crossover section.
- Low Z – Channel is configured for low-Z loads.

Input Mode: The options are

- CH1+CH2 (Ch. 1 input signal and Ch. 2 input signal are summed and fed to both output channels.) This provides a 6 dB level boost.
- INPUT Y (Ch. 1 input signal goes to Ch. 1 and Ch. 2 output. Ch. 2 input signal is ignored.)
- STEREO (Ch. 1 input goes to Ch. 1 output. Ch. 2 input goes to Ch. 2 output.)

XOV (Crossover): The available crossover frequencies are: OFF, 90 Hz, 100 Hz, 1200 Hz, 1500 Hz, 2000 Hz, 2-CH SUB, CUSTOM.

When you call up the XOY process, Ch. 1 will always be set to low frequencies and Ch. 2 will always be set to high frequencies. DO NOT connect high-frequency drivers to Ch. 1.

EQ (Equalization for Ch. 1 or Ch. 2): The options are OUT or IN. When set to "IN", equalization that you set up in System Architect software is applied to the signal. When set to "OUT", equalization is bypassed.

DEL (Delay for Ch. 1 or Ch. 2): The delay times are OFF, 1-10 msec, 10-50 msec, and 0 sec. "0 sec" is a placeholder for any delay time set in System Architect software.

BRG (Bridge-mono or Stereo): Use this option to set the amplifier to bridge-mono or stereo mode. When BRIDGE is active, the Ch. 1 input signal is used (unless you made an alternate setting with the Y processing block).

The tables on the next few pages describe what button sequence to press in order to achieve various functions. Four identical tables are provided, each in a different language, for easy use in the field.

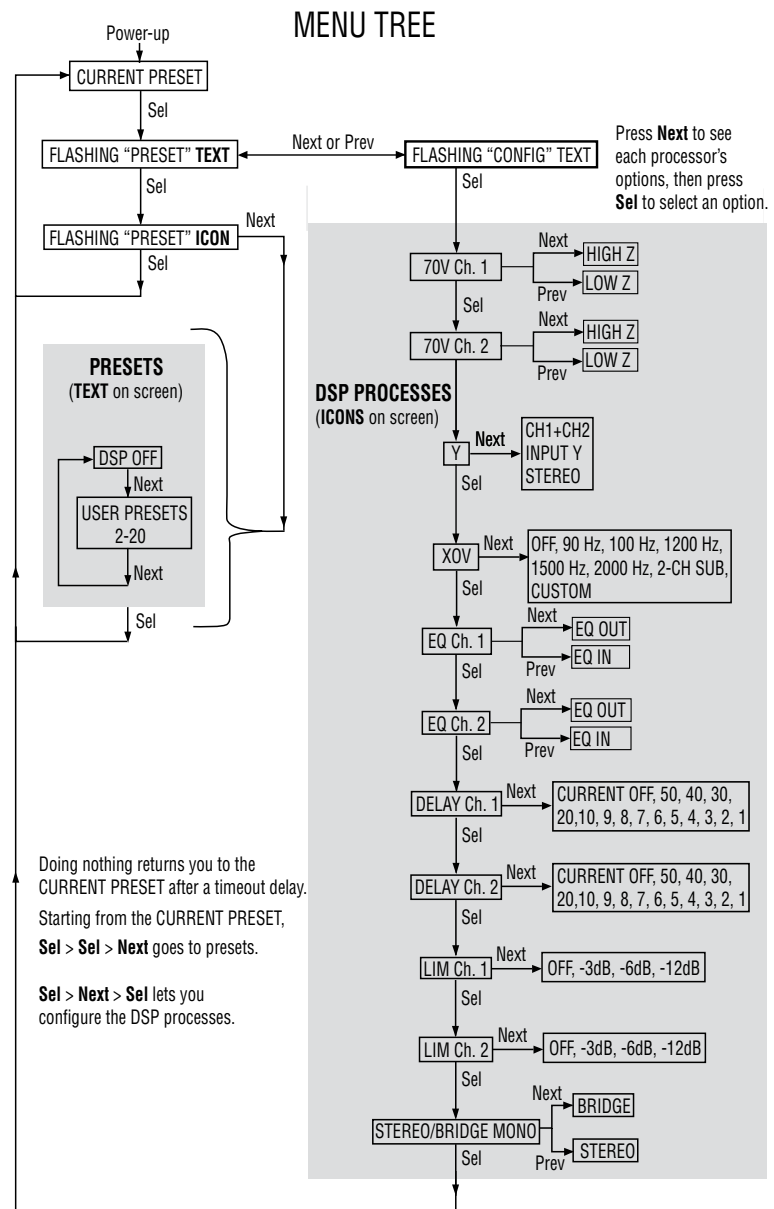

HOW TO ACCESS PRESETS AND DSP PROCESSES

DESIRED FUNCTION	BUTTON PRESSES (starting from the current preset screen)
Set up Ch. 1 output for 70V/high-Z mode	Sel > Next. Press Sel. The 70V and Ch. 1 icon flash. Press Next to turn on or off. Choose on or off by pressing Sel.
Set DUAL or BRIDGE-MONO mode manually	Sel > Next. Press Sel until the BRG icon flashes. Press Next to set the amplifier to Bridge-Mono, or press Prev to set the amplifier to Stereo. Press Sel to select your choice.
Select a user preset	Sel > Sel. Press Next until you see PRESET 2-20. Press Sel.
Set INPUT Y mode	Sel > Next. Press Sel until the Y icon flashes. Press Next to see the three options. Choose one by pressing Sel.
Turn EQ on or off for Ch. 1 or Ch. 2	Sel > Next. Press Sel until the EQ icon flashes along with CH1 or CH2. Press Next to set EQ in or out. Press Sel.
Set DELAY for Ch. 1 or Ch. 2	Sel > Next. Press Sel until the DEL icon flashes along with CH1 or CH2. Press Next until you see the amount of delay you want, then press Sel to select it.
Set LIMITING for Ch. 1 or Ch. 2	Sel > Next. Press Sel until the LIM icon flashes along with CH1 or CH2. Press Next until you see the limiting threshold you want, then press Sel to select it.
Turn off all the DSP	Sel > Sel. Press Next until you see DSP OFF. Press Sel.
Configure a USER PRESET	1. Sel > Sel . 2. Press Next until you see the desired preset. Press Sel to select it. 3. Sel > Next. 4. Press Sel until you see the DSP process you want to apply to that preset. 5. Press Next to see the processing options, then press Sel to select an option. 6. Repeat Steps 1-5 for all the processes you wish to apply to that preset. The CUSTOM ICON will light if a factory preset has been modified.



* When you call up the XOY process, Ch.1 will always be set to low frequencies and Ch. 2 will always be set to high frequencies. DO NOT connect high-frequency drivers to Ch. 1.

5 Troubleshooting

Thermal ● **CONDITION: Normal operation.**

Clip ●

-10 ○

-20 ○

Signal ○

Ready ○

- This is normal operation for your amp.

Thermal ● **CONDITION: Distorted sound.**

Clip ○

-10 ○

-20 ○

Signal ○

Ready ○

- Input signal level is too high. Turn down your amplifier Level controls. NOTE: Your amplifier should never be operated at a level which causes the Clip LEDs to illuminate constantly.

Power ● **CONDITION: No power to the amplifier.**

- The amplifier's Power switch is off.
- The amplifier's power cord is unplugged.

Thermal ○ **CONDITION: No sound.**

Clip ○

-10 ○

-20 ○

Signal ○

Ready ○

- The amplifier is in "fault" mode. A Fault status can be triggered when one of the amplifier's protection circuits is activated. First disconnect your speakers from the affected channel(s) one by one to determine if one of the loads is shorted. If the indicators return to normal status, then try a different speaker or cable to determine where the short is occurring. If no short can be found, turn off the amp and allow the amp to cool. If indicators do not return to normal after restarting your amp, check the fuse and replace if necessary, or return amp to Crown or an authorized Crown Service Center for servicing.

Power ● **CONDITION: No sound.**

- The amplifier has just turned on and is still in the 4-second turn-on delay.

Thermal ○

Clip ●

-10 ●

-20 ●

Signal ●

Ready ●

- Channel is in thermal protection.

Thermal ●

Clip ●

-10 ●

-20 ●

Signal ●

Ready ○

- No input signal
- Input signal level is very low.
- Level controls are turned down.

Thermal ●

Clip ●

-10 ○

-20 ○

Signal ○

Ready ○

- Speakers not connected.

6 Specifications

Minimum Guaranteed Power	CDi 1000	CDi 2000	CDi 4000	CDi 6000
Per channel, both channels driven				
2 ohm Dual (per channel)	700W*	1,000W*	1,600W*	3,000W*
4 ohm Dual (per channel)	500W	800W	1,200W	2,100W
8 ohm Dual (per channel)	275W	475W	650W	1,200W
4 ohm Bridge-Mono	1,400W*	2,000W*	3,200W*	6,000W*
70V Dual (per channel)	500W	800W	1000W	2,500W
140V Bridge-Mono	1000W	1600W	2000W	—
With 0.5% THD				
*With 1% THD				

Frequency Response (at 1 watt into 4 ohms, 20Hz - 20 kHz)	+0/-1 dB
Signal to Noise Ratio (below rated 8-ohm power at 1 kHz, A-weighted)	CDi 1K, 2K, 4K: 100 dB CDi 6K: 103 dB
Damping Factor (8 ohm): 20 Hz to 400 Hz	> 500
Input Stage	Input is electronically balanced and employs precision 1% resistors
AC Line Current	CDi 1000: 6.8A, CDi 2000: 8.3A, CDi 4000: 10.5A; at idle draws no more than 38 watts. CDi 6000: 15.3A; at idle draws no more than 180 watts.
Crosstalk (below rated power) 20 Hz to 1 kHz	> 70 dB

Input Impedance (nominal)	20 kilohms balanced, 10 kilohms unbalanced
Load impedance (note: safe with all types of loads) Dual Bridge mono	2-8 ohms 4-16 ohms
Voltage Gain (at 1 kHz, 8 ohm rated output)	CDi 1000: 30.5 dB, CDi 2000: 32.9 dB, CDi 4000: 34.2 dB, CDi 6000: 37.1 dB.
Sensitivity (at 8 ohm rated output)	1.4V
Maximum Input Signal	+22 dBu typical
Operating Temperature	0° C to 40° C at 95% relative humidity (non-condensing)
AC Line Voltage and Frequency Configurations Available (± 10%)	100V, 120V, 220-240V 50/60 Hz
Ventilation	Flow-through ventilation from front to back
Cooling	Heat sinks and proportional-speed fan
Dimensions: Width, Height, Depth (behind mounting surface)	EIA Standard 19" W (EIA RS-310-B) x 3.5" (8.9 cm) H x 12.25" (31.1 cm) D CDi 6000 is 16.2 in. (41.15 cm) D
Net Weight, Shipping Weight	CDi 1K, 2K, 4K: 19 lb (8.6 kg) CDi 6K: 24 lb (10.9 kg)

7 Service

Crown amplifiers are quality units that rarely require servicing. Before returning your unit for service, please contact Crown Technical Support to verify the need for servicing.

This unit has very sophisticated circuitry which should only be serviced by a fully trained technician. This is one reason why each unit bears the following label:

CAUTION: To prevent electric shock, do not remove covers. No user serviceable parts inside. Refer servicing to a qualified technician.



Complete the Crown Audio Factory Service Information form, in the back of this manual, when returning a Crown product to the factory or authorized service center. The form must be included with your product inside the box or in a packing slip envelope securely attached to the outside of the shipping carton. Do not send this form separately.

**Warranty is only valid within the United States of America. For information on Warranty outside of the U.S.A, please contact your local distributor.*

7.1 International and Canada Service

Service may be obtained from an authorized service center. (Contact your local Crown/Amcron representative or our office for a list of authorized service centers.) To obtain service, simply present the bill of sale as proof of purchase along with the defective unit to an authorized service center. They will handle the necessary paperwork and repair.

Remember to transport your unit in the original factory pack.

7.2 US Service

Service may be obtained in one of two ways: from an authorized service center or from the factory. You may choose either. It is important that you have your copy of the bill of sale as your proof of purchase.

7.2.1 Service at a US Service Center

This method usually saves the most time and effort. Simply present your bill of sale along with the defective unit to an authorized service center to obtain service. They will handle the necessary paperwork and repair.

Remember to transport the unit in the original factory pack. A list of authorized service centers in your area can be obtained from Crown Factory Service, or online from <http://www.crownaudio.com/support/servcent.htm>.

7.2.2 Factory Service

Crown accepts no responsibility for non-serviceable product that is sent to us for factory repair. It is the owner's responsibility to ensure that their product is serviceable prior to sending it to the factory. Serviceable product list is available at <http://crownweb.crownintl.com/crownrma/>. For more information, please contact us direct.

A Service Return Authorization (SRA) is required for product being sent to the factory for repair. An SRA can be completed online at www.crownaudio.com/support/factserv.htm. If you do not have access to the web, please call Crown's Customer Service at 574.294.8200 or 800.342.6939 extension 8205.

For warranty service, we will pay for ground shipping both ways in the United States. Contact Crown Customer Service to obtain prepaid shipping labels prior to sending the unit. Or, if you prefer, you may prepay the cost of shipping, and Crown will reimburse you. Send copies of the shipping receipts to Crown to receive reimbursement. Your repaired unit will be returned via UPS ground. Please contact us if other arrangements are required.

7.2.3 Factory Service Shipping Instructions:

1. Service Return Authorization (SRA) is required for product being sent to the factory for service. Please complete the SRA by going to www.crownaudio.com/support/factserv.htm. If you do not have access to our website, call 1.800.342.6939, extension 8205 and we'll create the SRA for you.
2. See packing instructions that follow.
3. Ship product to:
CROWN AUDIO FACTORY SERVICE
1718 W MISHAWKA RD.
ELKHART, IN 46517
4. Use a bold black marker and write the SRA number on three sides of the box.

5. Record the SRA number for future reference. The SRA number can be used to check the repair status.

7.2.4 Packing Instructions

Important: These instructions must be followed. If they are not followed, Crown Audio, Inc. assumes no responsibility for damaged goods and/or accessories that are sent with your unit.

1. Fill out and include the Crown Audio Factory Service Information sheet in the back of this manual.
2. Do not ship any accessories (manuals, cords, hardware, etc.) with your unit. These items are not needed to service your product. We will not be responsible for these items.
3. When shipping your Crown product, it is important that it has adequate protection. We recommend you use the original pack material when returning the product for repair. If you do not have the original box, please call Crown at 800.342.6939 or 574.294.8210 and order new pack material. See instructions for "foam-in-place" shipping pack. (Do not ship your unit in a wood or metal cabinet.)
4. If you provide your own shipping pack, the minimum recommended requirements for materials are as follows:
 - a. 275 P.S.I. burst test, Double-Wall carton that allows for 2-inch solid Styrofoam on all six sides of unit or 3 inches of plastic bubble wrap on all six sides of unit.
 - b. Securely seal the package with an adequate carton sealing tape.
 - c. Do not use light boxes or "peanuts". Damage caused by poor packaging will not be covered under warranty.

Using your 'foam-in-place' shipping pack

Note: The foam-in-place packing is molded so that there is only one correct position for your product.

1. Open carton and lift center cushion leaving both end-cushions in place.

2. Carefully place your product with the product's front panel facing the same direction as arrows indicate.
3. Reset center cushion down over top of product's chassis. The foam-in-place packing was molded to accommodate different chassis depth sizes. If your product's chassis does not completely fill the foam-in-place cavity, you may use a soft but solid packing material (such as paper or bubble wrap) behind the chassis.
4. Enclose the completed Crown Audio Factory Service Information form (or securely attach it to the outside of carton) and re-seal the shipping pack with a sturdy carton sealing tape.

7.2.5 Estimate Approval

Approval of estimate must be given within 30 days after being notified by Crown Audio Inc. Units still in the possession of Crown after 30 days of the estimate will become the property of Crown Audio Inc.

7.2.6 Payment of Non-Warranty Repairs

Payment on out-of-warranty repairs must be received within 30 days of the repair date. Units unclaimed after 30 days become the property of Crown Audio Inc.

If you have any questions, please contact Crown Factory Service.

Crown Factory Service
1718 W. Mishawaka Rd.,
Elkhart, Indiana 46517 U.S.A.

Telephone:
574.294.8200

800.342.6939 (North America,
Puerto Rico, and Virgin Islands only)

Facsimile:
574.294.8301 (Technical Support)
574.294.8124 (Factory Service)

Internet:
<http://www.crownaudio.com>

8 Warranty



SUMMARY OF WARRANTY

Crown International, 1718 West Mishawaka Road, Elkhart, Indiana 46517-4095 U.S.A. warrants to you, the ORIGINAL PURCHASER and ANY SUBSEQUENT OWNER of each NEW Crown product, for a period of three (3) years from the date of purchase by the original purchaser (the "warranty period") that the new Crown product is free of defects in materials and workmanship. We further warrant the new Crown product regardless of the reason for failure, except as excluded in this Warranty.

**Warranty is only valid within the United States of America. For information on Warranty outside of the U.S.A, please contact your local distributor.*

ITEMS EXCLUDED FROM THIS CROWN WARRANTY

This Crown Warranty is in effect only for failure of a new Crown product which occurred within the Warranty Period. It does not cover any product which has been damaged because of any intentional misuse, accident, negligence, or loss which is covered under any of your insurance contracts. This Crown Warranty also does not extend to the new Crown product if the serial number has been defaced, altered, or removed.

WHAT THE WARRANTOR WILL DO

We will remedy any defect, regardless of the reason for failure (except as excluded), by repair, replacement, or refund. We may not elect refund unless you agree, or unless we are unable to provide replacement, and repair is not practical or cannot be timely made. If a refund is elected, then you must make the defective or malfunctioning product available to us free and clear of all liens or

UNITED STATES & CANADA

other encumbrances. The refund will be equal to the actual purchase price, not including interest, insurance, closing costs, and other finance charges less a reasonable depreciation on the product from the date of original purchase. Warranty work can only be performed at our authorized service centers or at the factory. Warranty work for some products can only be performed at our factory. We will remedy the defect and ship the product from the service center or our factory within a reasonable time after receipt of the defective product at our authorized service center or our factory. All expenses in remedying the defect, including surface shipping costs in the United States, will be borne by us. (You must bear the expense of shipping the product between any foreign country and the port of entry in the United States including the return shipment, and all taxes, duties, and other customs fees for such foreign shipments.)

HOW TO OBTAIN WARRANTY SERVICE

You must notify us of your need for warranty service within the warranty period. All components must be shipped in a factory pack, which, if needed, may be obtained from us free of charge. Corrective action will be taken within a reasonable time of the date of receipt of the defective product by us or our authorized service center. If the repairs made by us or our authorized service center are not satisfactory, notify us or our authorized service center immediately.

DISCLAIMER OF CONSEQUENTIAL AND INCIDENTAL DAMAGES

YOU ARE NOT ENTITLED TO RECOVER FROM US ANY INCIDENTAL DAMAGES RESULTING FROM

ANY DEFECT IN THE NEW CROWN PRODUCT. THIS INCLUDES ANY DAMAGE TO ANOTHER PRODUCT OR PRODUCTS RESULTING FROM SUCH A DEFECT. SOME STATES DO NOT ALLOW THE EXCLUSION OR LIMITATIONS OF INCIDENTAL OR CONSEQUENTIAL DAMAGES, SO THE ABOVE LIMITATION OR EXCLUSION MAY NOT APPLY TO YOU.

WARRANTY ALTERATIONS

No person has the authority to enlarge, amend, or modify this Crown Warranty. This Crown Warranty is not extended by the length of time which you are deprived of the use of the new Crown product. Repairs and replacement parts provided under the terms of this Crown Warranty shall carry only the unexpired portion of this Crown Warranty.

DESIGN CHANGES

We reserve the right to change the design of any product from time to time without notice and with no obligation to make corresponding changes in products previously manufactured.

LEGAL REMEDIES OF PURCHASER

THIS CROWN WARRANTY GIVES YOU SPECIFIC LEGAL RIGHTS, YOU MAY ALSO HAVE OTHER RIGHTS WHICH VARY FROM STATE TO STATE. No action to enforce this Crown Warranty shall be commenced after expiration of the warranty period.

THIS STATEMENT OF WARRANTY SUPERSEDES ANY OTHERS CONTAINED IN THIS MANUAL FOR CROWN PRODUCTS. 9/07

THIS PAGE INTENTIONALLY LEFT BLANK



PRODUCT REGISTRATION

Crown Audio, Inc.
1718 W. Mishawaka Rd.
Elkhart, IN 46517-9439
Phone: 574-294-8000
Fax: 574-294-8329
www.crownaudio.com

Online registration is also available at <http://crownweb.crownintl.com/webregistration>.

**Warranty is only valid within the United States of America. For information on Warranty outside of the U.S.A, please contact your local distributor.*

When this form is used to register your product, it may be mailed or faxed.

Crown Audio, Inc. Fax: 574-294-8329
1718 W Mishawaka Rd
Elkhart IN 46517

Please note that some information is required. Incomplete registrations will not be processed. * Indicates required information.

OWNER'S INFORMATION - PLEASE PRINT

* First name: _____ Middle initial: _____ * Last name: _____
Company: _____
* Mailing address: _____
* City: _____ * State: _____ * Zip Code: _____
* Country: _____ E-mail address: _____
* Phone # (include area code): _____ Fax #: _____

PRODUCT INFORMATION

* MODEL	* SERIAL #	* PURCHASE DATE
e.g. IT8000, CDi1000, PCC160	e.g. 8000000000	mo/day/yr
_____	_____	____/____/____
_____	_____	____/____/____
_____	_____	____/____/____
_____	_____	____/____/____

Product purchased from: *(Business/Individual) _____ Country: _____

Comments: _____

CUT ON THIS LINE

THIS PAGE INTENTIONALLY LEFT BLANK

Crown Audio Factory Service Information

Shipping Address: Crown Audio Factory Service, 1718 W. Mishawaka Rd., Elkhart, IN 46517

PLEASE PRINT CLEARLY

SRA #: _____ (If sending product to Crown factory service.) Model: _____ Serial Number: _____ Purchase Date: _____

PRODUCT RETURN INFORMATION

Individual or Business Name: _____

Phone #: _____ Fax #: _____ E-Mail: _____

Street Address (please, no P.O. Boxes): _____

City: _____ State/Prov: _____ Postal Code: _____ Country: _____

Nature of problem: _____

Other equipment in your system: _____

If warranty is expired, please provide method of payment. Proof of purchase may be required to validate warranty.

PAYMENT OPTIONS

I have open account payment terms. Purchase order required. PO#: _____ COD

Credit Card (Information below is required; however if you do not want to provide this information at this time, we will contact you when your unit is repaired for the information.)

Credit card information:

Type of credit card: MasterCard Visa American Express Discover

Type of credit card account: Personal/Consumer Business/Corporate

Card # _____ Exp. date: _____ * Card ID #: _____

* Card ID # is located on the back of the card following the credit card #, in the signature area. On American Express, it may be located on the front of the card. This number is required to process the charge to your account. If you do not want to provide it at this time, we will call you to obtain this number when the repair of your unit is complete.

Name on credit card: _____

Billing address of credit card: _____

