



ULX-D Dual and Quad

Wireless Microphone System

User guide for Shure ULXD Dual and Quad wireless system. Includes setup instructions, specifications, and troubleshooting.
Version: 1 (2019-G)

Table of Contents

ULX-D Dual and Quad Wireless Microphone System	4	Setting Receiver Gain	26
IMPORTANT SAFETY INSTRUCTIONS	4	Receiver Gain Controls	26
WARNING	5	Reading the Audio Meter	26
Important Product Information	5	Muting a Receiver Channel Audio Output	27
LICENSING INFORMATION	5	Transmitter Input Clip	27
Information to the user	6	Audio Summing	27
Australia Warning for Wireless	6	Receiver Output Level	28
Quickstart Instructions	6	Scan and Sync	29
General Description	7	Multiple System Setup	30
Dual and Quad Receiver Models	8	Manual Frequency Selection	31
Hardware Interface	8	RF	31
Receiver	9	Transmitter RF Power	31
Receiver Home Screen	11	Interference Detection	31
Transmitters	12	High Density Mode	32
Boundary and Gooseneck Base Transmitters	14	Frequency Diversity	32
Advanced Transmitter Features	15	Setting Regional TV Format	33
Locking Controls and Settings	16	Custom Groups	33
Home Screen Display Options	16	Audio Signal Encryption	34
Menu Screens	17	RF Cascade Ports	34
Transmitter IR Presets	23	Antenna Bias	34
Creating a System Preset	24	Networking ULX-D Receivers	35
Batteries	24	Network Control Software	35
Battery Runtime Charts	24	IP Address Configuration	35
Shure SB900 Rechargeable Battery	25	Networking Acronyms	36
Shure SB900 Runtime	25	Overview of Dante Network Modes	36
Important Tips for Care and Storage of Shure Rechargeable Batteries	25	Network Connection and Configuration Examples	37
Installing the Battery Contact Cover	26	Assigning Network Device IDs for Shure Control and Dante Control	43
		Configuring Audio Routes with the Dante Controller	44
		Network Troubleshooting	46
		Restoring Dante Factory Settings	46

System Reset	47	Firmware Mismatch	50
		Radio Frequency (RF)	50
Firmware	47		
Firmware Versioning	47	Accessories	51
Updating the Receiver	47	Furnished Accessories	51
Updating the Transmitter	48	Optional Accessories	53
Connecting to an External Control System	48	Specifications	54
Setting the Gateway to Allow Cross Subnet Routing	48	ULXD4D & ULXD4Q	55
		ULXD1	56
Managing Your System with Shure Software	48	ULXD2	58
		Tables and Diagrams	59
Troubleshooting	49	Batteries	60
Power	49	Frequency Range and Transmitter Output Power	60
Gain	49		
Cables	49	Certifications	67
Interface Locks	49	Information to the user	68
Encryption Mismatch	49		

ULX-D Dual and Quad Wireless Microphone System









IMPORTANT SAFETY INSTRUCTIONS

1. READ these instructions.
2. KEEP these instructions.
3. HEED all warnings.
4. FOLLOW all instructions.
5. DO NOT use this apparatus near water.
6. CLEAN ONLY with dry cloth.
7. DO NOT block any ventilation openings. Allow sufficient distances for adequate ventilation and install in accordance with the manufacturer's instructions.
8. DO NOT install near any heat sources such as open flames, radiators, heat registers, stoves, or other apparatus (including amplifiers) that produce heat. Do not place any open flame sources on the product.
9. DO NOT defeat the safety purpose of the polarized or grounding type plug. A polarized plug has two blades with one wider than the other. A grounding type plug has two blades and a third grounding prong. The wider blade or the third prong are provided for your safety. If the provided plug does not fit into your outlet, consult an electrician for replacement of the obsolete outlet.
10. PROTECT the power cord from being walked on or pinched, particularly at plugs, convenience receptacles, and the point where they exit from the apparatus.
11. ONLY USE attachments/accessories specified by the manufacturer.
12. USE only with a cart, stand, tripod, bracket, or table specified by the manufacturer, or sold with the apparatus. When a cart is used, use caution when moving the cart/apparatus combination to avoid injury from tip-over.



13. UNPLUG this apparatus during lightning storms or when unused for long periods of time.
14. REFER all servicing to qualified service personnel. Servicing is required when the apparatus has been damaged in any way, such as power supply cord or plug is damaged, liquid has been spilled or objects have fallen into the apparatus, the apparatus has been exposed to rain or moisture, does not operate normally, or has been dropped.
15. DO NOT expose the apparatus to dripping and splashing. DO NOT put objects filled with liquids, such as vases, on the apparatus.
16. The MAINS plug or an appliance coupler shall remain readily operable.
17. The airborne noise of the Apparatus does not exceed 70dB (A).
18. Apparatus with CLASS I construction shall be connected to a MAINS socket outlet with a protective earthing connection.
19. To reduce the risk of fire or electric shock, do not expose this apparatus to rain or moisture.
20. Do not attempt to modify this product. Doing so could result in personal injury and/or product failure.
21. Operate this product within its specified operating temperature range.

Explanation of Symbols

	Caution: risk of electric shock
	Caution: risk of danger (See note.)
	Direct current
	Alternating current
	On (Supply)
	Equipment protected throughout by DOUBLE INSULATION or REINFORCED INSULATION
	Stand-by
	Equipment should not be disposed of in the normal waste stream

WARNING: Voltages in this equipment are hazardous to life. No user-serviceable parts inside. Refer all servicing to qualified service personnel. The safety certifications do not apply when the operating voltage is changed from the factory setting.

WARNING: Danger of explosion if incorrect battery replaced. Operate only with AA batteries.

Note: Use only with the included power supply or a Shure-approved equivalent.

WARNING

- Battery packs may explode or release toxic materials. Risk of fire or burns. Do not open, crush, modify, disassemble, heat above 140°F (60°C), or incinerate.
- Follow instructions from manufacturer
- Only use Shure charger to recharge Shure rechargeable batteries
- **WARNING:** Danger of explosion if battery incorrectly replaced. Replace only with same or equivalent type.
- Never put batteries in mouth. If swallowed, contact your physician or local poison control center
- Do not short circuit; may cause burns or catch fire
- Do not charge or use battery packs other than Shure rechargeable batteries
- Dispose of battery packs properly. Check with local vendor for proper disposal of used battery packs.
- Batteries (battery pack or batteries installed) shall not be exposed to excessive heat such as sunshine, fire or the like

Important Product Information

LICENSING INFORMATION

Licensing: A ministerial license to operate this equipment may be required in certain areas. Consult your national authority for possible requirements. Changes or modifications not expressly approved by Shure Incorporated could void your authority to operate the equipment. Licensing of Shure wireless microphone equipment is the user's responsibility, and licensability depends on the user's classification and application, and on the selected frequency. Shure strongly urges the user to contact the appropriate telecommunications authority concerning proper licensing, and before choosing and ordering frequencies.

Information to the user

This device complies with part 15 of the FCC Rules. Operation is subject to the following two conditions:

1. This device may not cause harmful interference.
2. This device must accept any interference received, including interference that may cause undesired operation.

These limits are designed to provide reasonable protection against harmful interference in a residential installation. This equipment generates uses and can radiate radio frequency energy and, if not installed and used in accordance with the instructions, may cause harmful interference to radio communications. However, there is no guarantee that interference will not occur in a particular installation. If this equipment does cause harmful interference to radio or television reception, which can be determined by turning the equipment off and on, the user is encouraged to try to correct the interference by one or more of the following measures:

- Reorient or relocate the receiving antenna.
- Increase the separation between the equipment and the receiver.
- Connect the equipment to an outlet on a circuit different from that to which the receiver is connected.
- Consult the dealer or an experienced radio/TV technician for help.

Note: EMC conformance testing is based on the use of supplied and recommended cable types. The use of other cable types may degrade EMC performance.

Please follow your regional recycling scheme for batteries, packaging, and electronic waste.

Australia Warning for Wireless

This device operates under an ACMA class licence and must comply with all the conditions of that licence including operating frequencies. Before 31 December 2014, this device will comply if it is operated in the 520-820 MHz frequency band.

WARNING: After 31 December 2014, in order to comply, this device must not be operated in the 694-820 MHz band.



Quickstart Instructions

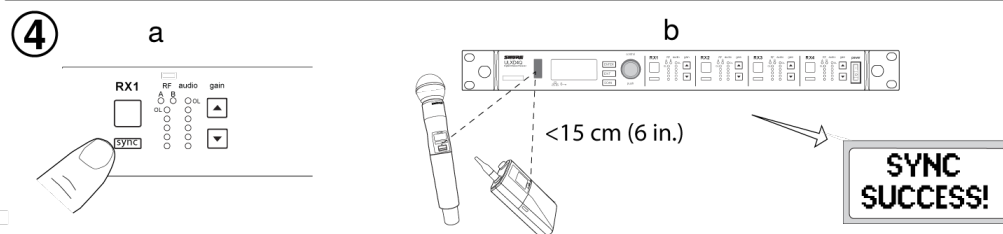
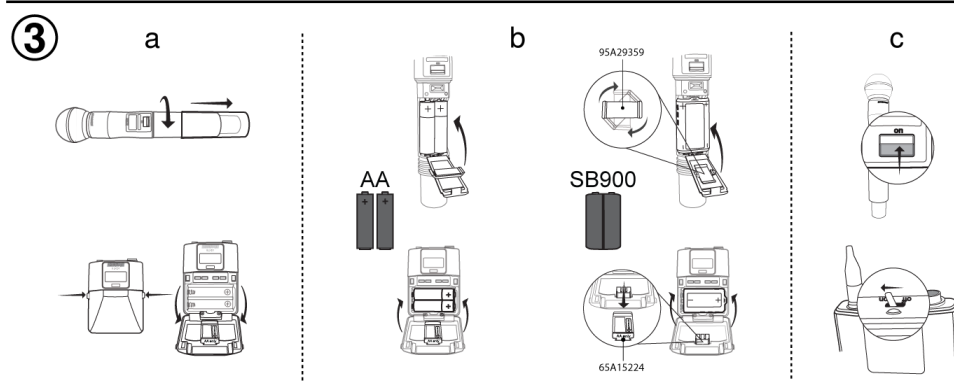
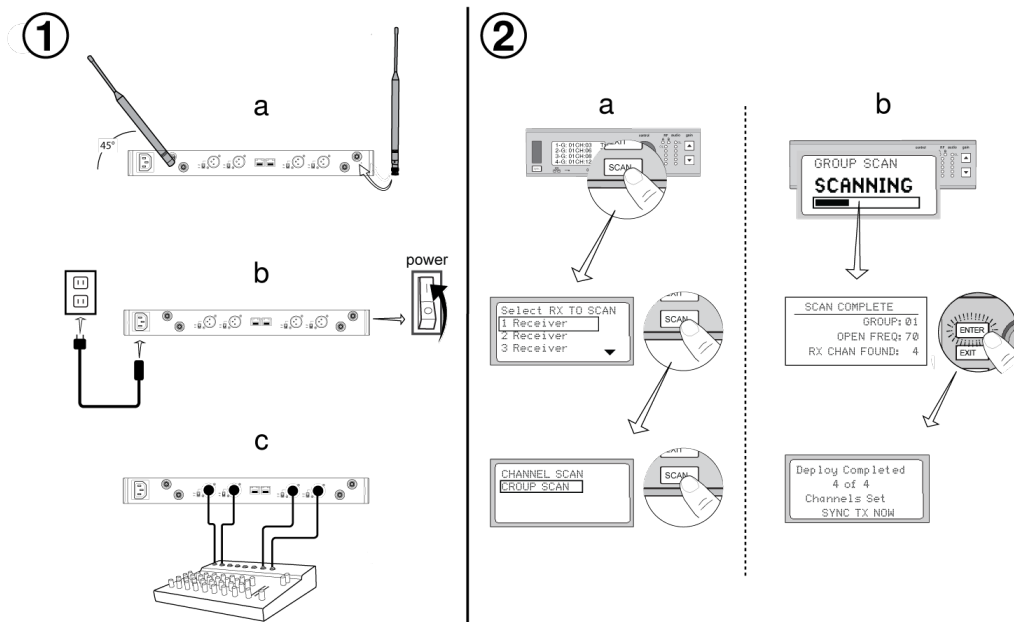

General Description

Shure ULX-D™ Digital Wireless offers uncompromising 24-bit audio quality and RF performance, with intelligent, encryption-enabled hardware, flexible receiver options, and advanced rechargeability options for professional sound reinforcement.

A breakthrough in wireless audio quality, Shure digital processing enables ULX-D to deliver the purest reproduction of source material ever available in a wireless system, with a wide selection of trusted Shure microphones to choose from. Extended 20 Hz – 20 kHz frequency range and flat response captures every detail with clarity, presence, and incredibly accurate low end

and transient response. With greater than 120 dB, ULX-D delivers wide dynamic range for excellent signal-to-noise performance. Optimized for any input source, ULX-D eliminates the need for transmitter gain adjustments.

ULX-D sets a new and unprecedented standard for spectral efficiency and signal stability. The intermodulation performance of ULX-D is an incredible advancement in wireless performance, enabling a dramatic increase in the number of simultaneous active transmitters on one TV channel. Rock-solid RF signal with zero audio artifacts extends over the entire range. For applications where secure wireless transmission is required, ULX-D offers Advanced Encryption Standard (AES) 256-bit encrypted signal for unbreakable privacy.

For scalability and modular flexibility, ULX-D receivers come in single, dual, and even quad channel versions. The dual and quad channel receivers offer conveniences such as RF cascade, internal power supply, bodypack frequency diversity, audio output channel summing, and Dante™ digital networking for multi-channel audio over Ethernet. All receivers offer High-Density mode for applications where high channel counts are needed, greatly increasing the amount of simultaneous channels possible over one frequency band.

Advanced Lithium-ion rechargeability provides extended transmitter battery life over alkaline batteries, battery life metering in hours and minutes accurate to within 15 minutes, and detailed tracking of battery health status.

Generations ahead of any other available system in its class, ULX-D brings a new level of performance to professional sound reinforcement.

Dual and Quad Receiver Models

The ULXD4 receiver is available in dual channel and quad channel models. Both models share the same feature set and functionality, but differ in the number of channels available and the number of audio outputs.

The descriptions and procedures in this guide are applicable to either the dual or the quad receiver.

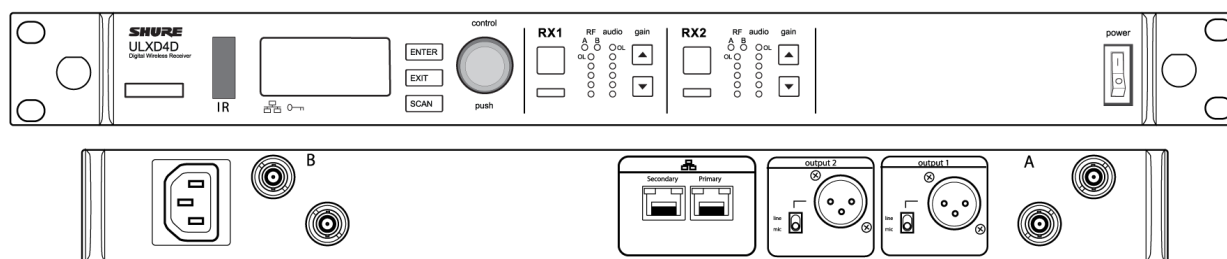

ULXD4D Dual Receiver

Supports 2 channels of wireless audio.

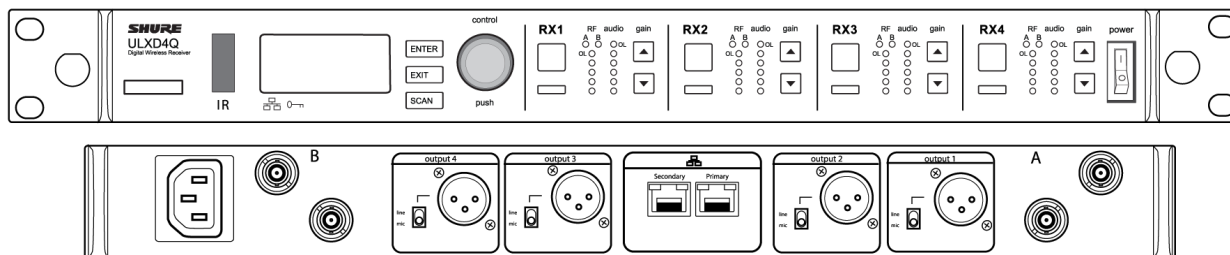

ULXD4Q Quad Receiver

Supports 4 channels of wireless audio.

Hardware Interface

Receiver

Front Panel

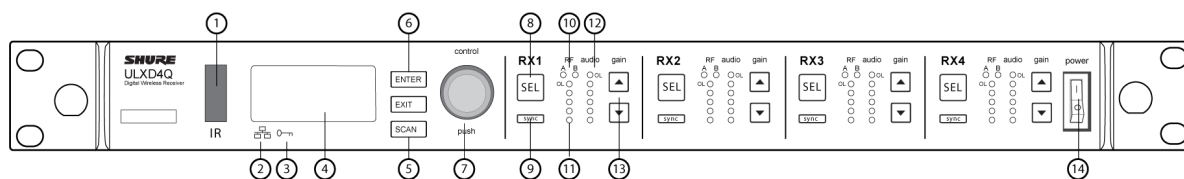

① Infrared (IR) Sync Window

Sends IR signal to the transmitter for sync.

② Network Icon

Illuminates when the receiver is connected with other Shure devices on the network. IP Address must be valid to enable networked control.

③ Encryption Icon

Illuminates when AES-256 encryption is activated.

④ LCD Panel

Displays settings and parameters.

⑤ Scan Button

Press to find the best channel or group.

⑥ Menu Navigation Buttons

Use to navigate and select parameter menus.

⑦ Control Wheel

- Push to select a channel or menu item
- Turn to scroll through menu items or to edit a parameter value

⑧ Channel Select Button

Press to select a channel.

⑨ Sync Button

Press the *sync* button while the receiver and transmitter IR windows are aligned to transfer settings from the receiver to the transmitter.

⑩ RF Diversity LEDs

Indicate antenna status:

- Blue = normal RF signal between the receiver and transmitter
- Red = interference detected
- Off = No RF connection between the receiver and transmitter

Note: the receiver will not output audio unless one blue LED is illuminated.

11 RF Signal Strength LEDs

Indicate the RF signal strength from the transmitter:

- Amber = Normal (-90 to -70 dBm)
- Red = Overload (greater than -25 dBm)

12 Audio LEDs

Indicate average and peak audio levels:

LED	Audio Signal Level	Description
Red (6)	-0.1 dBFS	Normal peaks
Yellow (5)	-6 dBFS	
Yellow (4)	-12 dBFS	
Green (3)	-20 dBFS	Signal Present
Green (2)	-30 dBFS	
Green (1)	-40 dBFS	

Note: In Frequency Diversity mode, simultaneous blinking of the red and yellow audio LEDs indicates that diversity audio has been routed to this channel.

13 Gain Buttons

Press the ▲ ▼ gain buttons on the front of the receiver to incrementally adjust gain from -18 to +42 dB.

14 Power Switch

Powers the unit on or off.

Back Panel

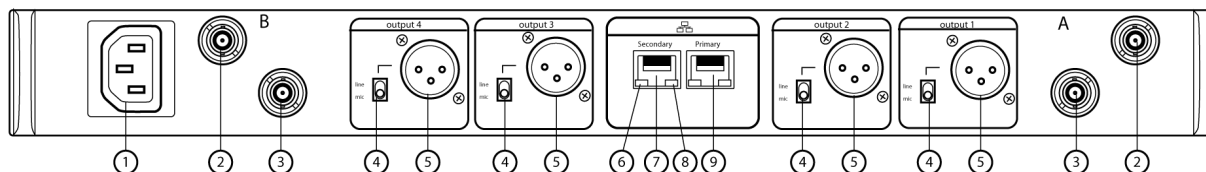

1 AC Power Input

IEC Connector, 100 - 240 V AC.

② RF Antenna Diversity Input Jack (2)

For antenna A and antenna B.

③ RF Cascade Jack (2)

Passes the RF signal from Antenna A and Antenna B to one additional receiver.

④ Mic/Line Switch (one per channel)

Applies a 30 dB pad in *mic* position.

⑤ Balanced XLR Audio Output (one per channel)

Connect to a mic or line level input.

⑥ Network Status LED (Green)

One per network port.

- Off = no link
- On = network link
- Flashing = network link active

⑦ Ethernet/Dante Network Secondary Port

Connect to an Ethernet network to enable remote device control via WWB6 software. Also carries Dante digital audio and control signals for audio distribution, monitoring, and recording - see Dante Network topic.

⑧ Network Speed LED (Amber)

One per network port.

- Off = 10/100 Mbps
- On = 1 Gbps

⑨ Ethernet/Dante Network Primary Port

Connect to an Ethernet network to enable remote device control via WWB6 software. Also carries Dante digital audio and control signals for audio distribution, monitoring, and recording - see Dante Network topic.

Receiver Home Screen

The home screen displays the following information for each receiver channel:

- Group and Channel
- Transmitter Status: *NoTx* or *TxOn*, battery icon/remaining battery life

Press the *SEL* button to access a channel menu screen.

1	G:01	CH:01	TxOn
2	G:01	CH:02	TxOn
3	G:01	CH:03	>9
4	G:01	CH:04	

Transmitters

① Power LED

- Green = unit is powered on
- Red = low battery or battery error (see Troubleshooting)
- Amber = power switch is disabled

② On/Off Switch

Powers the unit on or off.

③ SMA Connector

Connection point for RF antenna.

④ LCD Display:

View menu screens and settings. Press any control button to activate the backlight.

⑤ Infrared (IR) Port

Align with the receiver IR port during an IR Sync for automated transmitter programming.

⑥ Menu Navigation Buttons

Use to navigate through parameter menus and change values.

<i>exit</i>	Acts as a 'back' button to return to previous menus or parameters without confirming a value change
<i>enter</i>	Enters menu screens and confirms parameter changes
▼ ▲	Use to scroll through menu screens and to change parameter values

⑦ Battery Compartment

Requires Shure SB900A rechargeable battery or 2 AA batteries.

⑧ AA Battery Adapter

- Handheld: rotate and store in the battery compartment to use a Shure SB900A battery
- Bodypack: remove to accommodate a Shure SB900A battery

⑨ Bodypack Antenna

For RF signal transmission.

⑩ Integrated Antenna

For RF signal transmission.

⑪ Microphone Cartridge

See Optional Accessories for a list of compatible cartridges.

⑫ TA4M / LEMO Input Jack

Connects to a microphone or instrument cable.

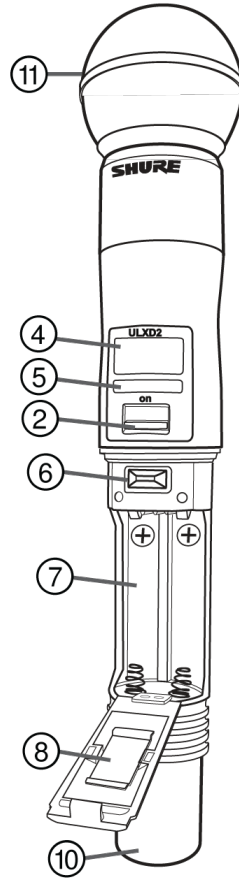
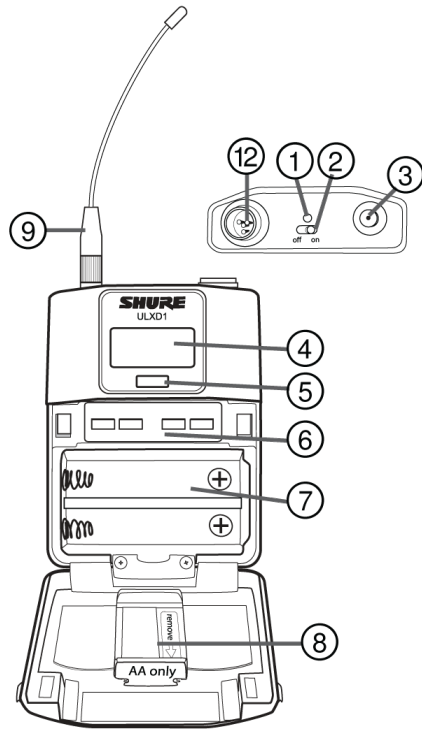

Boundary and Gooseneck Base Transmitters

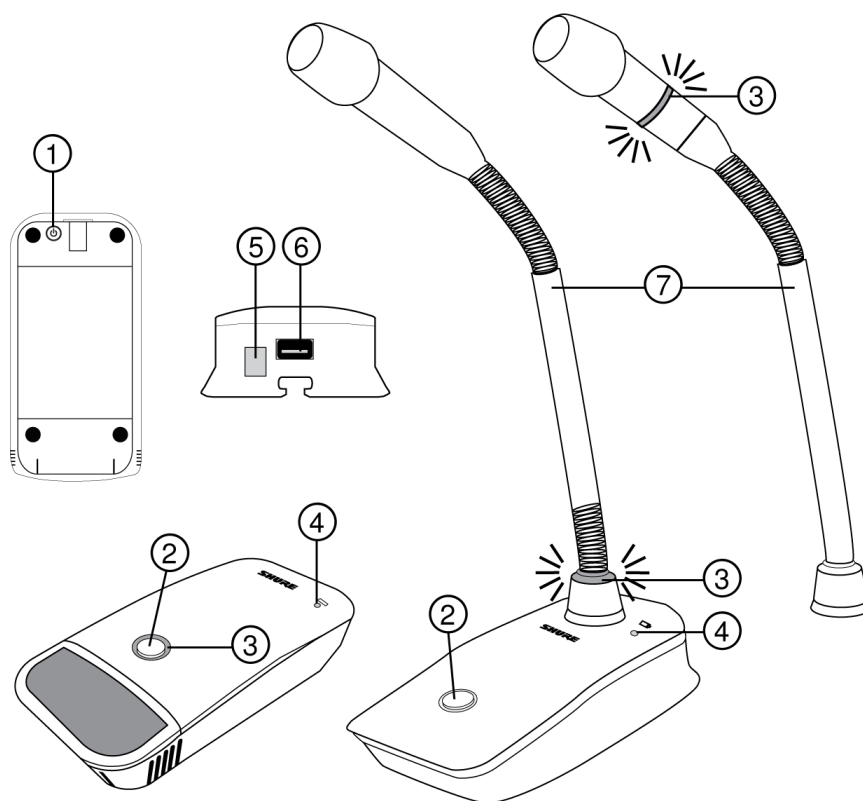

① Power Button

Press to power on; press and hold to power off.

② Mute/Active Button

Four settings are available for the mute/active button:

- Toggle: Press to switch between active and mute states
- Push-to-Mute: Hold button to mute microphone
- Push-to-Talk: Hold button to activate microphone
- Disabled: Button functionality off

③ Mute LED

Indicates whether microphone is active or muted. The following settings are available:

Active	Muted
Green*	Red*
Red	Off
Red	Flashing red

*MX400R series gooseneck microphones (red LED) do not offer this setting.

④ Low-Battery LED

- Off = More than 30 minutes of battery life remain
- On (red) = Less than 30 minutes of battery life remain
- On (green) = Microphone docked on charging station
- On (amber) = Battery is missing or is not inserted correctly

⑤ Infrared (IR) Port

Align with receiver IR port to send settings to transmitter.

⑥ Charge Connector

Connects to networked chargers and USB power supply.

⑦ Gooseneck Microphone

ULXD8 base fits 5", 10", and 15" Microflex series microphones, available in single or dualflex and with bi-color or red-only LEDs.

Advanced Transmitter Features

RF MUTE

Use this to turn on a transmitter without interfering with the RF spectrum.

Press and hold *exit* during power-on until *RF MUTED* is displayed. To un-mute, restart the transmitter.



MIC.OFFSET

MIC.OFFSET compensates for signal level differences between transmitters that share the same receiver channel.

Set the offset gain on a low signal level transmitter to match a louder transmitter: *UTILITY > MIC.OFFSET*

Note: For normal gain adjustments, use the receiver gain buttons.

Transmitter Audio Mute Mode

Mute Mode reconfigures the transmitter power switch to act a mute switch for the audio. Using the switch, the audio can be easily turned on or muted by presenters, sports referees, or anyone who periodically needs to speak. When the audio is muted, the transmitter RF signal remains on and ready at all times.

Note: Mute Mode can be selected as an *IR PRESET* option.

To set a transmitter to Mute Mode:

1. From the transmitter menu: *UTILITY > MUTE MODE*
2. Use the arrows to select *ON* or *OFF*.
3. Press *enter* to save.

Tip: The transmitter LED turns red when audio is muted and turns green when audio is enabled. The display of the transmitter will show *AUDIO MUTED* and the receiver display will show *Tx Muted*.

Note: Mute Mode must be set to *OFF* in order to use the power switch to turn off the transmitter.

Locking Controls and Settings

Use the *LOCK* feature to prevent accidental or unauthorized changes to the hardware.

Receiver

Menu path: *DEVICE UTILITIES > LOCK*

Use the control wheel to select and lock any of the following receiver functions.

- *MENU*: All menu paths are inaccessible
- *GAIN*: Gain adjustment is locked
- *POWER*: Power switch is disabled
- *SCAN*: Cannot perform a group scan
- *SYNC*: Cannot sync devices

Tip: To unlock, press the *EXIT* button, turn the control wheel to select *UNLOCKED*, and then press *ENTER* to save.

Transmitter

Menu path: *UTILITY > LOCK*

Use the transmitter controls to select and lock any of the following transmitter functions.

- *MENU LOCK*: All menu paths are inaccessible.
- *POWER LOCK*: Power switch is disabled

Quick-Lock Option: To turn on the transmitter with its power and menu navigation buttons locked, press and hold the **▲** button during power-on until the locked message is displayed.

Tip: To unlock the *MENU LOCK*, press the *ENTER* button 4 times to pass through the following screens: *UTILITY > LOCK > MENU UNLOCK*

To unlock the *POWER LOCK*, set the power switch to the *off* position, then press and hold the **▲** button while resetting the power switch to the *on* position.

Home Screen Display Options

Receiver

```

470.150 MHz
G: 01 CH: 01
GAIN: +0dB   No Tx
  
```

```

G:01 CH:01
470.150MHz  8:37
GAIN: +0dB   ULXD1
  
```

```

CHANNAME
470.150MHz  8:37
+10dB       ULXD1
  
```

The *HOME INFO* menu provides options to change the information shown on the receiver home screen:

DEVICE UTILITIES > HOME INFO

Use the control wheel to select one of the following screen displays.

Transmitter



Home Screen: Press the ▲ ▼ arrows at the home menu to display one of the following screens:

Menu Screens

Receiver Channel

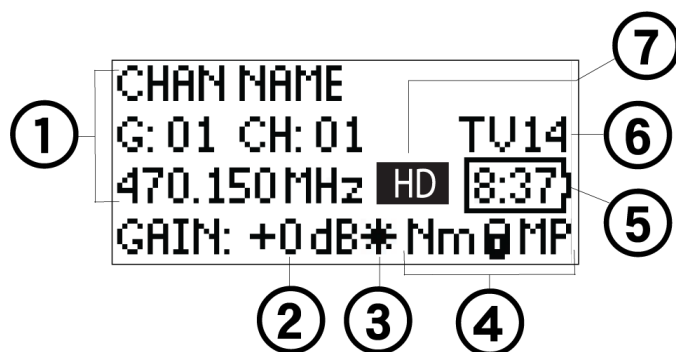

① Receiver Information

Use *DEVICE UTILITIES > HOME INFO* to change the home screen display.

② Gain Setting

-18 to +42 dB, or Mute.

③ Mic. Offset Indicator

Indicates offset gain is added to the transmitter.

④ Transmitter Settings

The following information cycles when a transmitter is tuned to the receiver's frequency:

- Transmitter Type
- Input Pad (Bodypack only)
- RF Power Level
- Transmitter Lock Status
- Transmitter Mute Status

⑤ Battery Runtime Indicator

Shure SB900 battery: runtime is displayed in minutes remaining.

AA batteries: runtime is displayed with a 5-bar indicator.

⑥ TV Channel

Displays the TV channel that contains the tuned frequency.

⑦ High Density Mode Icon

Displayed when High Density mode is enabled.

Transmitter Status

The following text or icons report transmitter status to the receiver screen:

Display Icon	Transmitter Status
	Bodypack input is attenuated 12 dB
	Offset gain is added to the transmitter
<i>Lo</i>	1 mW RF power level
<i>Nm</i>	10 mW RF power level
<i>Hi</i>	20 mW RF power level
<i>M</i>	Menu is locked
<i>P</i>	Power is locked
<i>TxMuted</i>	Displayed when the transmitter audio is set to off using the <i>MUTE MODE</i> feature
<i>-No Tx-</i>	No RF connection between a receiver and transmitter or transmitter OFF

Transmitter

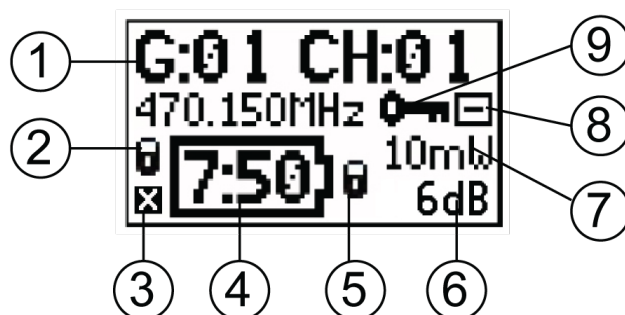

① Transmitter Information

Scroll ▲ ▼ at the home screen to change the display

② Power Lock Indicator

Indicates power switch is disabled

③ Transmitter Audio Muted Indicator

Displayed when the transmitter audio is set to off using the *MUTE MODE* feature.

④ Battery Runtime Indicator

- Shure SB900 battery: runtime is displayed in hours:minutes remaining
- AA Batteries: runtime is displayed with a 5-bar indicator

⑤ Menu Lock Indicator

Indicates menu navigation buttons are disabled

⑥ Mic. Offset

Displays microphone offset gain value

⑦ RF Power

Displays RF power setting

⑧ Bodypack Input Pad

The input signal is attenuated 12 dB

⑨ Encryption Icon

Indicates encryption is enabled on the receiver and has been transferred to the transmitter from a sync

Adjusting Receiver Display Brightness and Contrast

Adjust *BRIGHTNESS* and *CONTRAST* settings to improve visibility in challenging lighting environments.

1. From the receiver menu: *DEVICE UTILITIES > DISPLAY*
2. Press the control wheel to select *CONTRAST* or *BRIGHTNESS*.
3. Turn the control to adjust the selected parameter.
4. Press *ENTER* to save changes.

Editing Receiver Channel Name

To edit a receiver channel name, choose *EDIT NAME* from the menu.

- Turn the control wheel to edit a highlighted character
- Press the control wheel to advance to the next character
- Press *ENTER* to save changes

Note: The channel name is transferred to a transmitter during a sync.

Receiver Menu Descriptions

RADIO

Displays Group, Channel, Frequency, and TV information. Use the control wheel to edit values

G:

Group for the selected frequency

CH:

Channel for the selected frequency

FREQUENCY

Selected frequency (MHz)

TV:

Displays the TV channel for the selected frequency

*AUDIO***GAIN**

Use the control wheel or gain buttons to adjust the channel gain from -18 to 42 dB, in 1 dB increments.

MUTE

Mutes the receiver audio output.

EDIT NAME

Use the control wheel to assign and edit the selected receiver channel name.

*IR PRESETS***BODYPACK / HANDHELD****BP PAD**

Sets the audio input attenuation options: *KEEP, 0, -12*.

LOCK

Sets the lock options: *KEEP, Power, Menu, All, None*

RF POWER

Sets the transmitter RF power level: *KEEP, 10mW=Nm, 1mW=Lo, 20mW=Hi*.

BATT

Sets the transmitter battery type to ensure accurate metering: *KEEP, Alkaline, NiMH, Lithium*

BP OFFSET

Adjustable gain to compensate for signal level difference between transmitters: *KEEP, 0 to 21 dB in 3 dB increments*

HH OFFSET

Adjustable gain to compensate for signal level difference between transmitters: *KEEP, 0 to 21 dB in 3 dB increments*

MUTE MODE

Configures the transmitter power switch to act as an audio mute switch.

Cust. Group

Create Custom Groups of up to 6 frequencies and export to networked receivers

GOOSENECK / BOUNDARY

HIGH PASS

Attenuates frequencies below 150 Hz by 12 dB per octave: *KEEP, OFF, ON*

RF POWER

Sets the transmitter RF power level: *KEEP, 10mW=Nm, 1mW=Lo, 20mW=Hi*

BATTERY

Sets the transmitter battery type to ensure accurate metering: *KEEP, Alkaline, NiMH, Lithium*

BN OFFSET

Adjustable gain to compensate for signal level difference between transmitters: *KEEP, 0 to 21 dB in 3 dB increments*

GN OFFSET

Adjustable gain to compensate for signal level difference between transmitters: *KEEP, 0 to 21 dB in 3 dB increments*

POWER LOCK

Locks the transmitter's power button: *KEEP, OFF, ON*

Cust. Group

Create Custom Groups of up to 6 frequencies and export to networked receivers

INITIAL STATE FROM CHARGER

Choose the transmitter's state after it is removed from a charger: *KEEP, Active, Muted, OFF*

MUTE BUTTON BEHAVIOR

Sets the mute button behavior: *KEEP, Toggle, Push-to-Talk, Push-to-Mute, Disabled*

BN MUTE LED ACTIVE/MUTE

Sets the mute LED colors for active and muted states: *KEEP, Green/Red, Red/OFF, Red/Flash-Red, OFF/OFF*

GN MUTE LED ACTIVE/MUTE

Sets the mute LED colors for active and muted states: *KEEP, Green/Red, Red/OFF, Red/Flash-Red, OFF/OFF*

MUTE LED LIGHT BRIGHTNESS

Sets the mute LED brightness: *KEEP, Normal, Low*

BATTERY INFO

HEALTH

Percentage of charge capacity compared to a new battery

CHARGE

Percentage of charge capacity

CYCLES

Number of charge cycles logged by the battery

TEMP

Battery temperature: °C/°F

DEVICE UTILITIES

FREQ DIVERSITY

- OFF (default)
- 1 + 2
- 3 + 4 (quad only)
- 1 + 2 / 3 + 4 (quad only)

AUDIO SUMMING

- OFF (default)
- 1 + 2
- 3 + 4 (quad only)
- 1 + 2 / 3 + 4 (quad only)
- 1 + 2 + 3 + 4 (quad only)

ENCRYPTION

Set encryption: ON/OFF

ADVANCED RF

- HIGH DENSITY: ON/OFF
- CUSTOM GROUPS: SETUP/EXPORT/CLEAR
- ANTENNA BIAS: ON/OFF
- SWITCH BAND (Japan AB band only)

LOCK

- MENU: LOCKED/UNLOCKED
- GAIN: LOCKED/UNLOCKED
- POWER: LOCKED/UNLOCKED
- SCN/SYC: LOCKED/UNLOCKED

HOME INFO

Select screen options for Home Menu.

DISPLAY

- CONTRAST
- BRIGHTNESS: LOW/MEDIUM/HIGH

NETWORK

- CONFIGURATION: SWITCHED/REDUNDANT AUDIO/SPLIT
- SHURE CONTROL: DEVICE ID, Network Mode, Set IP and Subnet values for Ethernet network
- DANTE: DANTE DEVICE ID, AUDIO & CNTRL, REDUNDANT AUDIO, Set IP, Subnet, Gateway and Yamaha values for Dante™ network

Note: Additional information can be accessed from the selected networking option.

TX FW UPDATE

IR DOWNLOAD, Tx Firmware Version

SYSTEM RESET

- RESTORE: Default Settings, Presets
- SAVE: Create New Preset
- DELETE: Delete Preset

VERSION

- Model
- Band
- S/N (serial number)
- Ver
- Mcu
- FPGA
- Boot

Transmitter IR Presets

Use the *IR PRESETS* receiver menu to quickly configure transmitter settings from the receiver screen. When a sync is performed between the receiver and transmitter, the IR PRESETS automatically configure the transmitter. Each parameter has the default value *KEEP*, which leaves that setting unaffected by a sync.

Feature	Setting
BP PAD	+0 dB, -12 dB
LOCK	<i>Power, Menu, All, None</i>
RF POWER	<i>10mW=Nm (normal), 1mW=Lo (low), 20mW=Hi (high)</i>
BATT	<i>Alkaline, NiMH, Lithium</i>
BP OFFSET	0 dB to +21 dB (in 3 dB increments)
HH OFFSET	0 dB to +21 dB (in 3 dB increments)

Feature	Setting
MUTE MODE	OFF, ON
Cust. Group	OFF, ON

Note: When Cust. Groups is set to on, it may take up to 30 seconds to complete an IR sync.

Creating a System Preset

System Presets allow a current receiver setup to be saved and restored. Presets store all receiver settings to provide a quick way to configure a receiver or switch between several different setups. Up to 4 presets can be stored in receiver memory.

To save the current receiver setup as a new preset: **DEVICE UTILITIES > SYSTEM RESET > SAVE > CREATE NEW PRESET**

Use the control wheel to name the preset, and then press Enter to save.

To recall a saved preset: **DEVICE UTILITIES > SYSTEM RESET > RESTORE**

Use the control wheel to select the preset name, and then press Enter.

Batteries

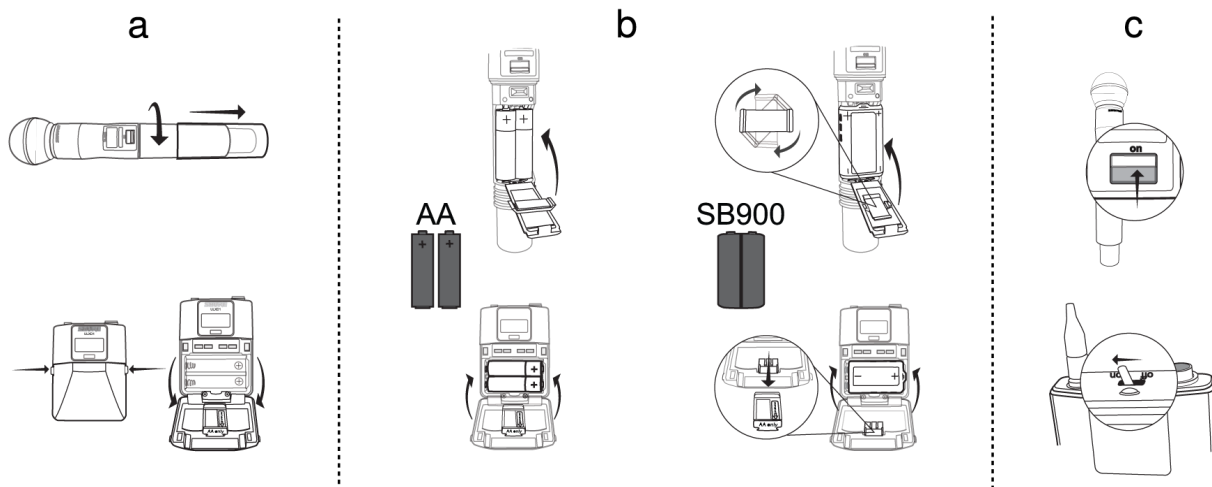

The transmitter runs on two AA batteries or the Shure SB900 rechargeable battery. Use the included AA battery adapter when using batteries other than the Shure SB900.

Bodypack: Remove the adapter when using the Shure SB900

Handheld: Rotate and store the adapter in battery door when using Shure SB900

Battery Runtime Charts

A 5-segment icon on the receiver and transmitter menu screens indicates battery charge.

For accurate battery runtime monitoring, set the transmitter to the appropriate battery type: **UTILITY > BATTERY > SET . AA . TYPE.**

The tables display the approximate hours and minutes remaining (h:mm).

Alkaline

Battery Indicator	UHF/VHF		ISM/1.x	
	1/10 mW	20 mW	1/10mW	20mW
	9:00 to 6:30	5:45 to 4:15	7:30 to 5:30	5:30 to 4:00
	6:30 to 4:00	4:15 to 3:00	5:30 to 3:30	4:00 to 2:45
	4:00 to 1:45	3:00 to 1:30	3:30 to 1:45	2:45 to 1:30
	1:45 to 0:45	1:30 to 0:30	1:45 to 0:45	1:30 to 0:30
	<0:45	<0:30	<0:45	<0:30
	Replace	Replace	Replace	Replace

Shure SB900 Rechargeable Battery

When using an SB900 rechargeable battery, the receiver and transmitter home screens display the number of hours and minutes remaining.

Detailed information for the SB900 is displayed in the receiver *BATTERY INFO* menu and the transmitter menu: *UTILITY > BATTERY > BATT. STATS*

HEALTH: Displays battery health as a percentage of the charge capacity of a new battery.

CHARGE: Percentage of a full charge

CYCLES: Number of times the battery has been charged

TEMP: Battery temperature in Celsius and Fahrenheit

Note: For additional rechargeable battery information, visit www.shure.com.

```
HEALTH: 90%
CHARGE: 80%
CYCLES: 100
TEMP: 10°C / 50°F
```

Shure SB900 Runtime

1 mW	10 mW	20 mW
>9 hours	>9 hours	>6 hour

Important Tips for Care and Storage of Shure Rechargeable Batteries

Proper care and storage of Shure batteries results in reliable performance and ensures a long lifetime.

- Always store batteries and transmitters at room temperature
- Ideally, batteries should be charged to approximately 40% of capacity for long-term storage

- During storage, check batteries every 6 months and recharge to 40% of capacity as needed

Installing the Battery Contact Cover

Install the included battery contact cover (65A15947) on the handheld transmitter to prevent light reflection in broadcast and performance situations.

1. Align the cover as shown.
2. Slide the cover over the battery contacts until it is flush with the transmitter body.

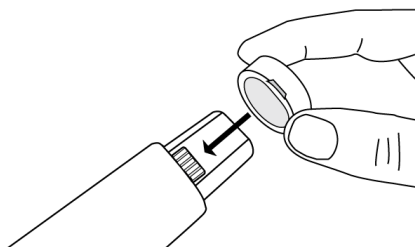

Note: Slide the cover off before inserting the transmitter in the battery charger.

Setting Receiver Gain

The receiver gain control sets the audio signal level for the entire receiver and transmitter system. Changes to the gain settings occur in realtime allowing for adjustments during live performances. When adjusting the gain, monitor the audio meter levels to prevent signal overloads.

Receiver Gain Controls

The gain can be adjusted by using the *gain* ▲ ▼ buttons or by entering the *AUDIO* menu and using the control wheel.

Tip: To quickly adjust the gain, press and hold a gain button to enable accelerated scrolling.

Reading the Audio Meter



The audio meter displays yellow, green, and red LEDs to indicate the audio signal level. Audio peaks illuminate the LEDs for 2 seconds, while the RMS signal is displayed in realtime.

When setting up the receiver, adjust the gain so that the average signal LED levels are solid green and occasionally yellow, with only the highest peaks causing the red LED to illuminate.

Tip: If a vocalist is overloading a bodypack transmitter, try lowering the receiver gain. If additional attenuation is needed, use the transmitter menu to set the *INPUT PAD* to *-12dB*.

Note: Illumination of the red *OL* (overload) LED indicates the internal limiter is engaged to prevent digital clipping.

Muting a Receiver Channel Audio Output

The audio output of each receiver channel can be independently muted to prevent audio from passing. Mute status is indicated by *Rx MUTED* message appearing on the receiver display in place of the gain value.

Note: Receiver gain is disabled for muted channels to prevent unexpected changes in audio levels.

To set a receiver channel output to mute:

1. *AUDIO > MUTE*
2. Use the control wheel to select *ON* or *OFF*.
3. Press *ENTER* to save.

To unmute the receiver output:

Simultaneously press the **▲ ▼** buttons or select *OFF* from the *MUTE* menu option.

Tip: Audio mute can be enabled remotely from *Wireless Workbench* or from an external controller.

Important! A power cycle will reset the receiver and unmute the audio output.

Transmitter Input Clip

The following warning displays on the receiver LCD panel when the transmitter input is clipped:



Tx OVERLOAD

To correct, select *INPUT PAD* from the main menu and attenuate the input signal by 12 dB. If the warning persists, reduce the level of input signal.

Audio Summing

Audio summing allows the dual and quad receivers to function as a 2 or 4 channel mixer, respectively. Summed audio is available on all outputs (Dante and XLR). For example, when *1 + 2* is selected (see diagram), the outputs of channels 1 and 2 supply the summed audio of the two channels.

Choosing an Audio Summing Mode

The following Audio Summing mode options are available:

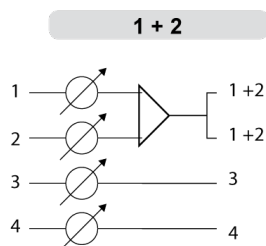

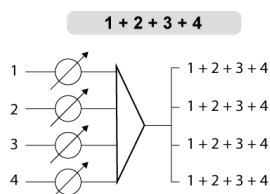
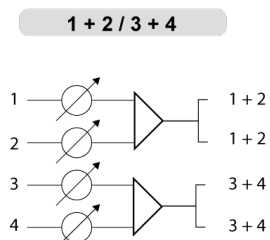
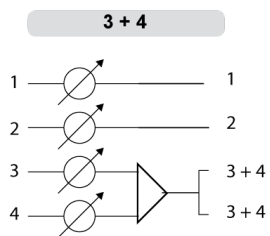

To select an Audio Summing mode:

1. Menu: *DEVICE UTILITIES* > *AUDIO SUMMING*
2. Use the control wheel to select an option, and then press *Enter*.

Note: When set to *OFF*, Audio Summing is disabled.

Adjusting Gain for Summed Outputs

Use the gain controls for each channel to create the overall mix balance. The front panel LEDs indicate the audio level for each channel. If an overload occurs, the red LEDs will illuminate indicating that the internal limiter is active and the display will show an overload message. To correct, adjust the overall gain balance.

Receiver Output Level

The following table describes the typical total system gain from the audio input to the receiver outputs:

Receiver Output Gain

Output Jack	System Gain (gain control = 0dB)
XLR (line setting)	+24 dB
XLR (mic setting)	-6 dB*

*This setting matches a typical wired SM58 audio signal level.

Scan and Sync

Use this procedure to tune a receiver and transmitter to the best open channel.

Important! Before you begin:

Turn off all transmitters to prevent them from interfering with the frequency scan.

Turn on any devices that might produce interference during the show so the scan can detect and avoid them, including:

- Other wireless systems or devices
- Computers
- CD players
- Large LED panels
- Effects processors

1. Press *SEL* to select a receiver channel.
2. Perform a group scan on the receiver: *SCAN > GROUP SCAN*.
3. Press *SCAN*. While the scan is running, *SCANNING* appears on the screen.
4. When the scan is done, the receiver displays the group with the most available frequencies. Press the flashing *ENTER* button to deploy frequencies to each receiver channel.
5. Power on the ULXD transmitter.
6. Press the *sync* button on the receiver.
7. Align the IR windows until the receiver IR port turns red.

Note: When complete, *SYNC SUCCESS!* appears. The transmitter and receiver are now tuned to the same frequency.

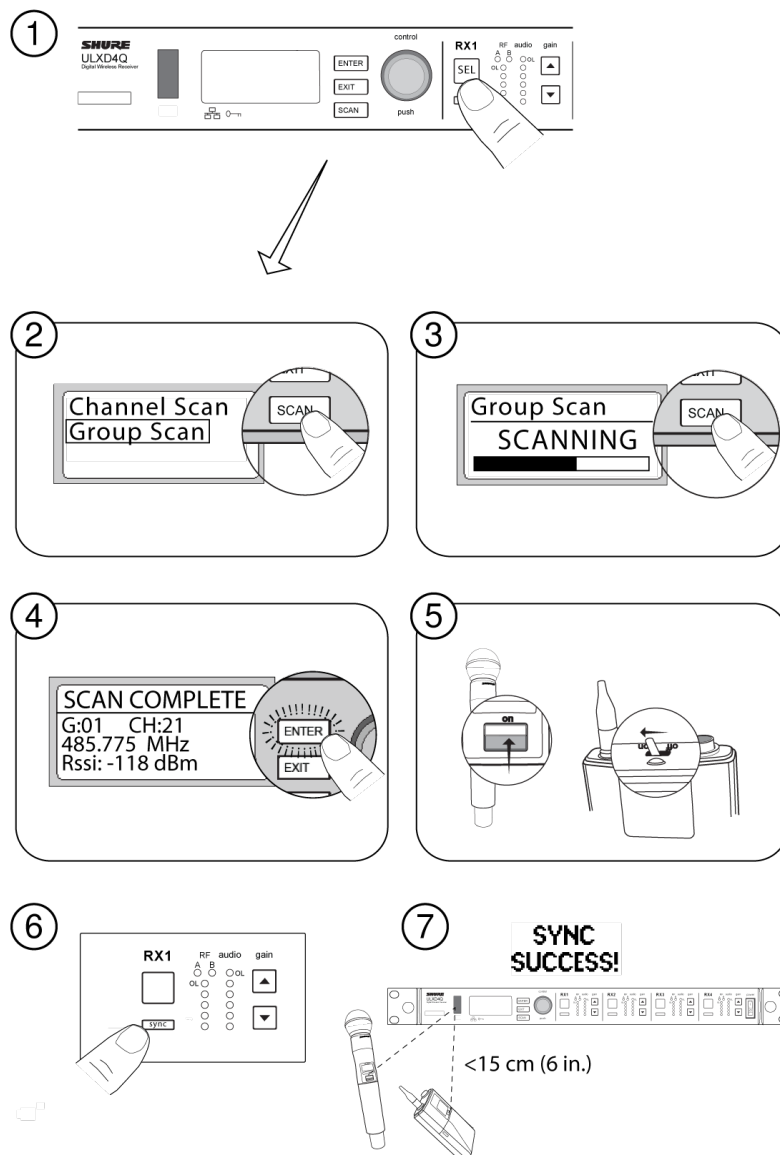

Multiple System Setup

A setup using networked receivers is the fastest and easiest way to distribute the best open channel to each system. See Networking ULX-D Receivers for networking details.

Note: Networked receivers must all be within the same frequency band.

Networked Receivers

1. Turn on all receivers.
2. Conduct a group scan on the first receiver to find available frequencies in each group: *SCAN > GROUP SCAN*.
3. Press *ENTER* to accept the group number and automatically assign the next best channel to each receiver on the network. The receiver LEDs will flash when a frequency has been assigned.
4. Turn on a transmitter and sync to the receiver.

Important! Leave the transmitter on and repeat this step for each additional system.

Non-networked Receivers

1. Turn on all receivers.
2. Conduct a group scan on the first receiver to find available frequencies in each group: *SCAN > SCAN > GROUP SCAN > SCAN*
3. When the scan is complete, use the control wheel to scroll through each group. Press *ENTER* to select a group that has enough available frequencies for all channels in the system.
4. Sync a transmitter to each receiver channel.

Important! Leave all transmitters on use the following steps to set up additional receiver channels:

1. Set each additional receiver channel to the same group as the first receiver: *RADIO > G :*
2. Conduct a channel scan to find available frequencies within the group: *SCAN > SCAN > CHANNEL SCAN > SCAN*
3. When the scan is complete, press *ENTER* to assign frequencies to each receiver channel.
4. Sync a transmitter to each receiver channel.

Manual Frequency Selection

To manually adjust group, channel, or frequency:

1. Press *SEL* to choose a receiver channel and navigate to the *RADIO* menu.
2. Use the control wheel to adjust the group, channel, or frequency.
3. Press *ENTER* to save changes.

RF

Transmitter RF Power

Reference the following table for setting RF Power:

RF Power Setting	System Range	Application
1 mW	33 m (100 ft.)	For increased channel reuse at close distances
10 mW	100 m (330 ft.)	Typical setups
20 mW	>100 m (330 ft.)	For hostile RF environments or long-distance applications

Note: Using the 20 mW setting decreases the transmitter battery runtime and reduces the number of compatible systems.

Interference Detection



Interference Detection monitors the RF environment for potential sources of interference which can cause audio dropouts.

When interference is identified, the RF LEDs illuminate red and the following warning displays on the receiver LCD panel.

If the warning display persists or the audio drops out repeatedly, perform a Scan and Sync at the first opportunity to find a clear frequency.

High Density Mode

High Density mode creates additional bandwidth for more channels in crowded RF environments. Frequency efficiency is optimized by running at 1 mW RF transmit power and narrowing the modulation bandwidth, allowing for the channel spacing to be reduced from 350 kHz to 125 kHz. Transmitters can be positioned on adjacent channels with unsubstantial intermodulation distortion (IMD).

High Density mode is ideal for applications where many channels are needed in a confined area, transmission distances are short, and the number of available frequencies is limited. Up to 30 meters of range is available in High Density mode.

Setting the Receiver to High Density Mode

To set the receiver to High Density mode:

DEVICE UTILITIES > ADVANCED RF > HIGH DENSITY

Use the control wheel to set *HIGH DENSITY* to *ON*.

When prompted, sync the transmitter and receiver to enable *HIGH DENSITY* mode.

Note: When the receiver is in *HIGH DENSITY* mode, the following indicators are shown on the receiver display:

- The *HD* icon will appear on the receiver display
- The receiver band name will be shown with an "HD" added. (example: The G50 band will appear as G50HD)
- The transmitter group and channel are assigned letters instead of numbers (example: G:AA CH:AA)

Best Practices for High Density Mode

- When band planning, position ULX-D High Density channels in a range of frequencies separated from other devices.
- Use a separate RF zone for ULX-D High Density channels to prevent intermodulation distortion from other devices.
- During High Density channel scanning, turn on all other transmitters and move them to their intended position.
- Perform a walk test to verify transmitter range
- If using custom groups, the groups loaded into the receiver must be compatible with High Density mode

Frequency Diversity

Frequency Diversity is an advanced ULX-D receiver feature that safeguards against loss of audio signal caused by RF interference or by power loss in a transmitter.

In Frequency Diversity mode, the signals from two transmitters from a common audio source are routed to the outputs of 2 receiver channels. In the event of interference or power loss, the audio from the good channel is switched to both outputs to preserve the audio signal. Switching between channels is seamless and inaudible.

When the receiver senses that the signal quality has improved, audio routing is restored without interrupting the audio signal.

Note: *WWB6* software offers an option to selectively lock the diversity audio source to a specific transmitter (see *Wireless Workbench 6* section).

Best Practices for Frequency Diversity

- Use the same microphone type and model for each transmitter
- Place microphones within close proximity to the source
- Use the gain controls to match the output levels for each receiver channel
- If Audio Summing is active, use a Y-cable (Shure AXT652) to connect the bodypacks to a single audio source to prevent comb filtering

Choosing Diversity Output Routing

The following receiver channel routing output options are available:

- 1 + 2
- 3 + 4 (quad only)
- 1 + 2 / 3 + 4 (quad only)

To enable Frequency Diversity and select a routing option:

DEVICE UTILITIES > FREQ DIVERSITY

Use the control wheel to choose a routing option, and then press *ENTER*.

Note: Choose *OFF* to disable Frequency Diversity.

Frequency Diversity and Encryption

Enabling Encryption while in Frequency Diversity mode provides an additional layer of protection by only passing audio from the most recently synced encrypted transmitter for each receiver channel.

Setting Regional TV Format

To ensure accurate display of TV channel information, set the *TVFORMAT* to match the TV channel bandwidth in the region where the receiver is operating. TV bandwidth varies globally, so check local regulations to determine the regional TV bandwidth.

The following *TVFORMAT* options are available:

- 6 MHz
- 7 MHz
- 8 MHz
- 6 MHz JAPAN
- NO TV (use to turn off TV channel display or in regions where TV channels are not applicable)

To set the *TVFORMAT*:

1. Menu: *DEVICE UTILITIES > ADVANCED RF > TV FORMAT*
2. Use the control wheel to select a *TVFORMAT* option.
3. Press *ENTER* to save.

Custom Groups

Use this feature to create and export up to 6 groups of manually selected frequencies to networked receivers prior to a group scan to simplify system set up.

Tip: Use Wireless Workbench or Wireless Frequency Finder to select the best compatible frequencies. See www.shure.com for more information.

To create a custom group: *DEVICE UTILITIES > ADVANCED RF > CUSTOM GROUPS > SETUP*

Use the control wheel to choose group, channel and frequency values. Press *ENTER* to save.

Prior to performing a group scan, export a custom group to networked receivers:

1. Go to *DEVICE UTILITIES > ADVANCED RF > CUSTOM GROUPS > EXPORT*
2. Press the flashing *ENTER* button to export all custom groups to all receivers on the network.

Note: Use the *CLEAR ALL* option to remove all custom group settings.

Audio Signal Encryption

When encryption is enabled, the receiver generates a unique encryption key which is shared with a the transmitter during an IR sync. Transmitters and receivers that share an encryption key form a protected audio path, preventing unauthorized access from other receivers.

Encrypting a Single Transmitter to a Single Receiver

1. From the receiver menu: *DEVICE UTILITIES > ENCRYPTION > ON (Auto)*
2. Press *ENTER*.
3. Perform an IR Sync to share the encryption key with the selected transmitter.

Encrypting Multiple Transmitters to a Single Receiver

Multiple transmitters can share the same encryption key, allowing them access to a single receiver. Use this method if you have multiple instruments or wish to use a combination of handheld and bodypack transmitters.

1. From the receiver menu: *DEVICE UTILITIES > ENCRYPTION > ON (Manual) > KEEP KEYS*.
2. Press *ENTER*.
3. Perform an IR Sync to share the encryption key with the first transmitter.
4. Turn off the transmitter and perform an IR Sync to share the key additional transmitters.

Caution! Make sure only one transmitter is turned on during an IR sync or a performance to avoid causing cross interference between transmitters.

Regenerating Encryption Keys

Periodically regenerating the encryption key maintains security for transmitters and receivers that are paired for extended periods.

1. From the receiver menu: *DEVICE UTILITIES > ENCRYPTION > ON (Manual) > REGENERATE KEYS*.
2. Press *ENTER*.
3. Perform an IR Sync to share the encryption key with the first transmitter.
4. Turn off the transmitter and perform an IR Sync to share the key additional transmitters.

Caution! Make sure only one transmitter is turned on during an IR sync or a performance to avoid causing cross interference between transmitters.

Removing Encryption

1. From the receiver menu: *DEVICE UTILITIES ENCRYPTION OFF*
2. Press *ENTER*.
3. IR Sync the transmitter and receiver to clear the encryption key.

Note: If multiple transmitters are encrypted to a single receiver, each transmitter must be IR synced to clear the encryption key.

RF Cascade Ports

The receiver has 2 RF cascade ports on the rear panel to share the signal from the antennas with 1 additional receiver.

Use a shielded coaxial cable to connect the RF cascade ports from the first receiver to the antenna inputs of the second receiver.

Important! The frequency band must be the same for both receivers.

Antenna Bias

Antenna ports A and B provide a DC bias to power active antennas. Set the DC power to off when using passive (non-powered) antennas.

To turn bias off: *DEVICE UTILITIES > ADVANCED RF > ANTENNA BIAS > OFF*

Networking ULX-D Receivers

ULX-D Dual and Quad receivers feature a Dante dual-port network interface. Dante technology provides an integrated solution to distribute digital audio, manage control signals, and carry Shure Control (WWB and AMX/Crestron) signals. Dante uses standard IP over Ethernet and safely coexists on the same network as IT and control data. Selectable Dante networking modes route port signals for flexible network set up.

Network Control Software

The ULX-D receivers can be controlled by Shure Control (WWB6) for remote management and monitoring and the Dante Controller to manage digital audio routing. Signals for AMX and Crestron controllers are carried on the same network as Shure Control.

Shure Control

Wireless Workbench 6 (WWB6) software provides comprehensive control for wireless audio systems. Wireless Workbench enables live remote adjustments to networked receivers for real-time changes to gain, frequency, RF power, and control locks. A familiar channel strip interface displays audio meters, transmitter parameters, frequency settings and network status.

Wireless Workbench 6 is available for Windows or Mac and can be downloaded at: www.shure.com/wwb

Dante

The Dante controller is a free software program created by Audinate™ to configure and manage a network of Dante enabled devices. Use the controller to create audio routes between networked components and to monitor the status of online devices.

Visit www.audinate.com for download and installation instructions.

IP Address Configuration

An IP address must be assigned to each device in the network to ensure communication and control between components. Valid IP addresses can assigned automatically using a DHCP server or manually from a list of valid IP addresses. If using Dante audio, a separate Dante IP address must also be assigned to the receiver.

Automatic IP Addressing

1. If using a DHCP capable Ethernet switch, set the DHCP switch to ON.
2. Set the IP Mode to Automatic for all receivers: *DEVICE UTILITIES > NETWORK > SHURE CONTROL > NETWORK*
3. Use the control wheel to set the mode to *Automatic*, press *ENTER* to save.

Note: Use only one DHCP server per network.

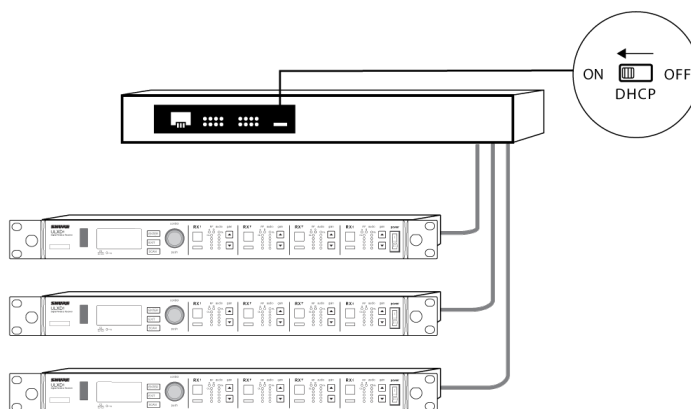

Manual IP Addressing

1. Connect the receivers to an Ethernet switch.
2. Set the IP Mode to Manual for all devices: *DEVICE UTILITIES* > *NETWORK* > *SHURE CONTROL* > *NETWORK*
3. Use the control wheel to set the mode to *Manual*.
4. Set valid IP addresses and subnet values for all devices, press *ENTER* to save.

Dante IP Addressing

IP addresses for a Dante network can assigned automatically using a DHCP server or manually from a list of valid IP addresses

To select the Dante IP addressing mode (Automatic or Manual): *DEVICE UTILITIES* > *NETWORK* > *DANTE* > *AUDIO & CNTRL*

Use the control wheel to select the mode, and then press *ENTER* to save.

Networking Acronyms

DHCP: Dynamic Host Configuration Protocol

LAN: Local Area Network

MCU: Micro Controller Unit

RJ45: Ethernet Connection

RX: Receiver

TX: Transmitter

WWB6: Wireless Workbench 6 Software

VLAN: Virtual Local Area Network

MAC: Machine Access Code

Overview of Dante Network Modes

The Dante network interface has two ports (Primary and Secondary) to provide flexible routing and configuration options for network signals.

Three selectable Dante network modes are available to control signal routing from the receiver ports to the Dante network.

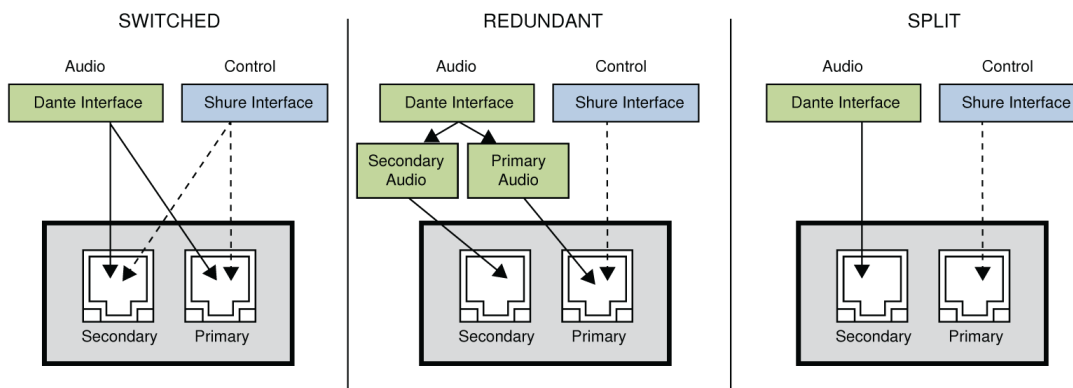

Network Mode	Port Function and Signals		Application
	Secondary	Primary	
SWITCHED	Shure Control Dante Audio and Control	Shure Control Dante Audio and Control	For single network installations of star or daisy-chained networks.
REDUNDANT AUDIO	Dante Redundant Audio	Shure Control Dante Audio and Control	Primary and Secondary ports are configured as 2 separate networks. The Secondary port carries a backup copy of the Primary digital audio signal.
SPLIT	Dante Audio and Control	Shure Control	Primary and Secondary ports are configured as 2 separate networks to provide isolation between control signals and audio signals.

Setting the Dante Networking Mode

Select a Dante mode to configure network signal routing on the Primary and Secondary ports. Set all receivers on the network to the same mode.

Note: Remove network connections from the receiver before changing the mode.

1. From the receiver menu: *DEVICE UTILITIES > NETWORK > CONFIGURATION*
2. Use the control wheel to select a mode (*SWITCHED, REDUNDANT AUDIO, SPLIT*)
3. Press *ENTER* to save.
4. Cycle receiver power to enable the mode change.

Network Connection and Configuration Examples

Note: Use shielded Cat5e cable for network connections to ensure reliable performance.

Switched Mode

Switched mode is typically used for single network installations of star or daisy-chained networks. Switched mode is recommended for installations that don't require Dante audio.

Network Characteristics:

- Dante Audio and Shure Control are present on both the Primary and Secondary ports
- The Dante IP address and the Shure Control IP address must be on the same subnet. The computer running WWB6 must also be on this subnet.

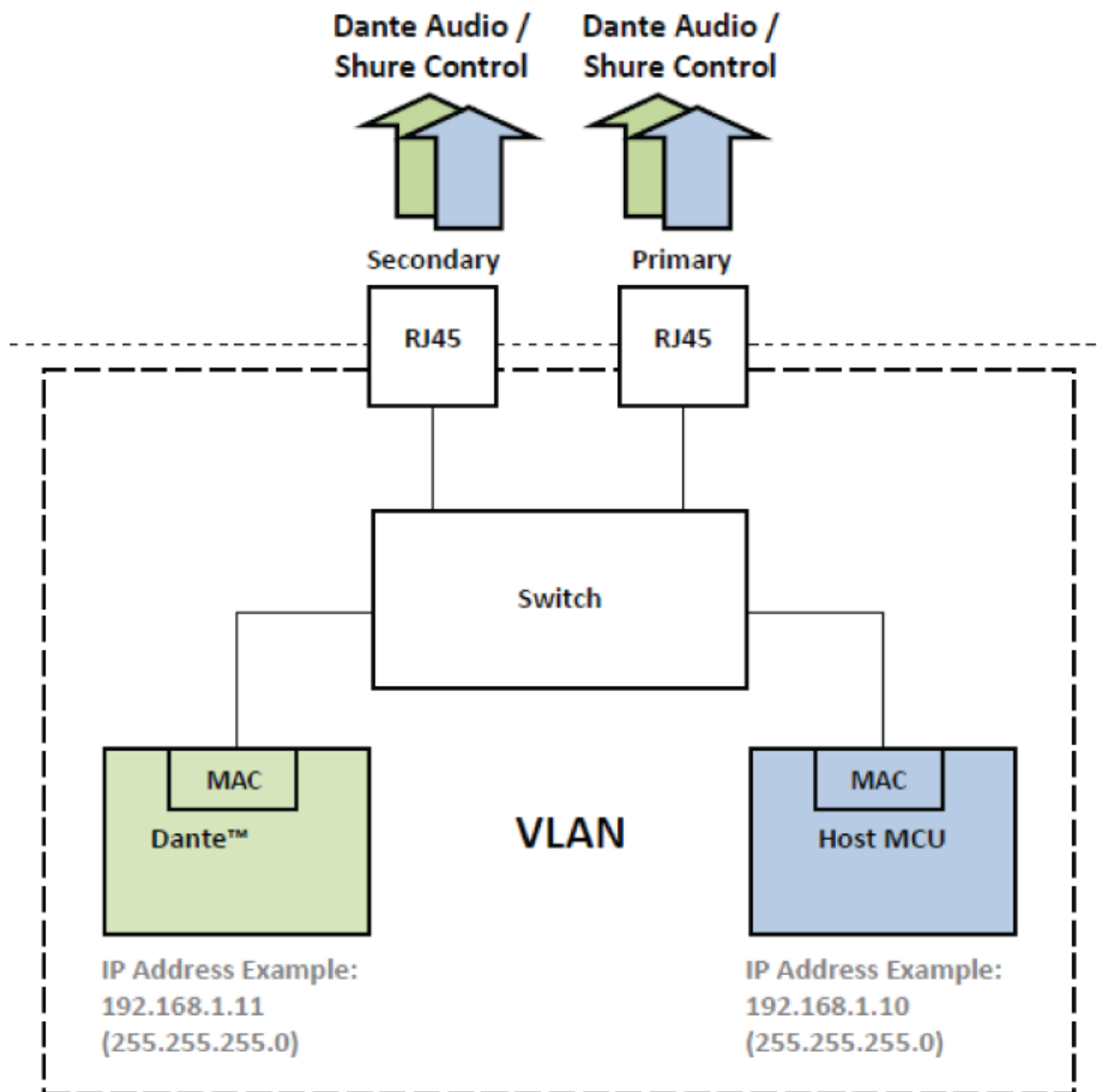

Network Example (Dante Audio + WWB6)

① Computer

Connect the computer running the Dante controller and WWB6 to the Primary port.

② DHCP Server

Can be configured with or without a DHCP server. Do not route audio through the server.

③ Gigabit Ethernet Switch

- Do not connect both network ports to the same Ethernet switch
- Use a star network topology to minimize audio latency

④ Receiver Connection

Connect receivers to the Primary port

⑤ Dante Receiver

Connect Dante receivers (mixers, recorders, amplifiers) to the Primary port.

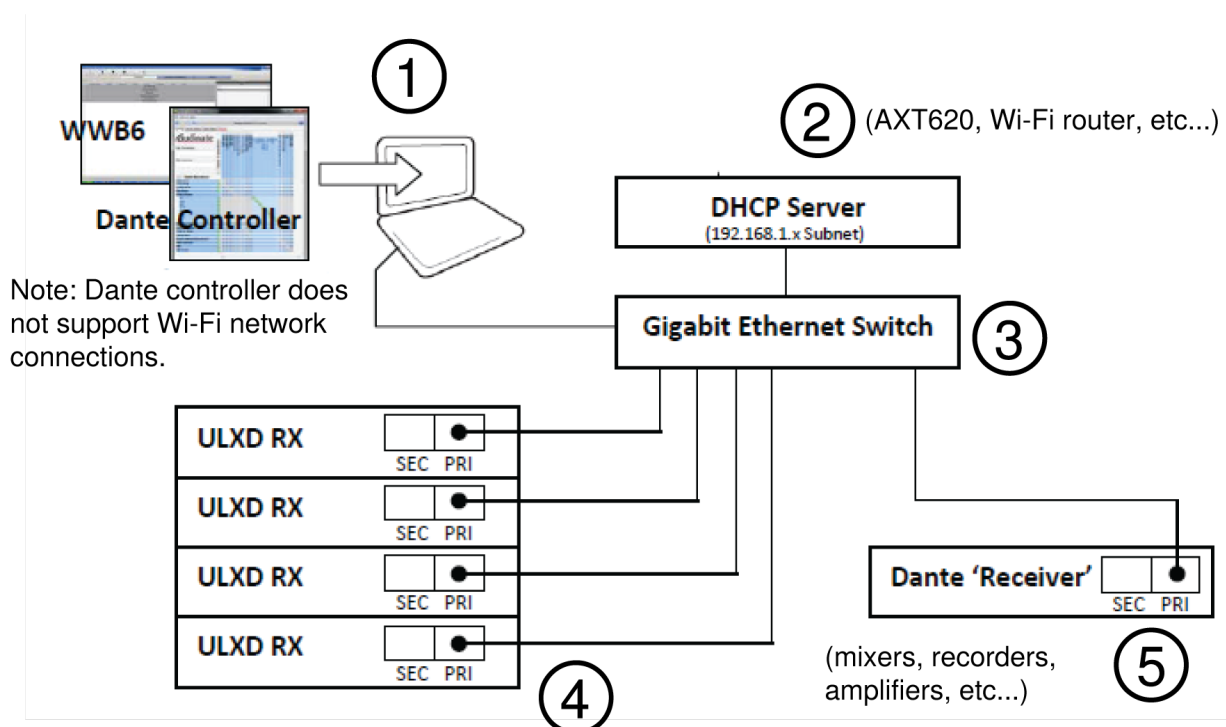

Network Example (WWB6 Only)

① Computer

Connect the computer running WWB6 to the Primary port.

② DHCP Server

Can be configured with or without a DHCP server.

③ Receiver Connection

Connect receivers to the Primary port

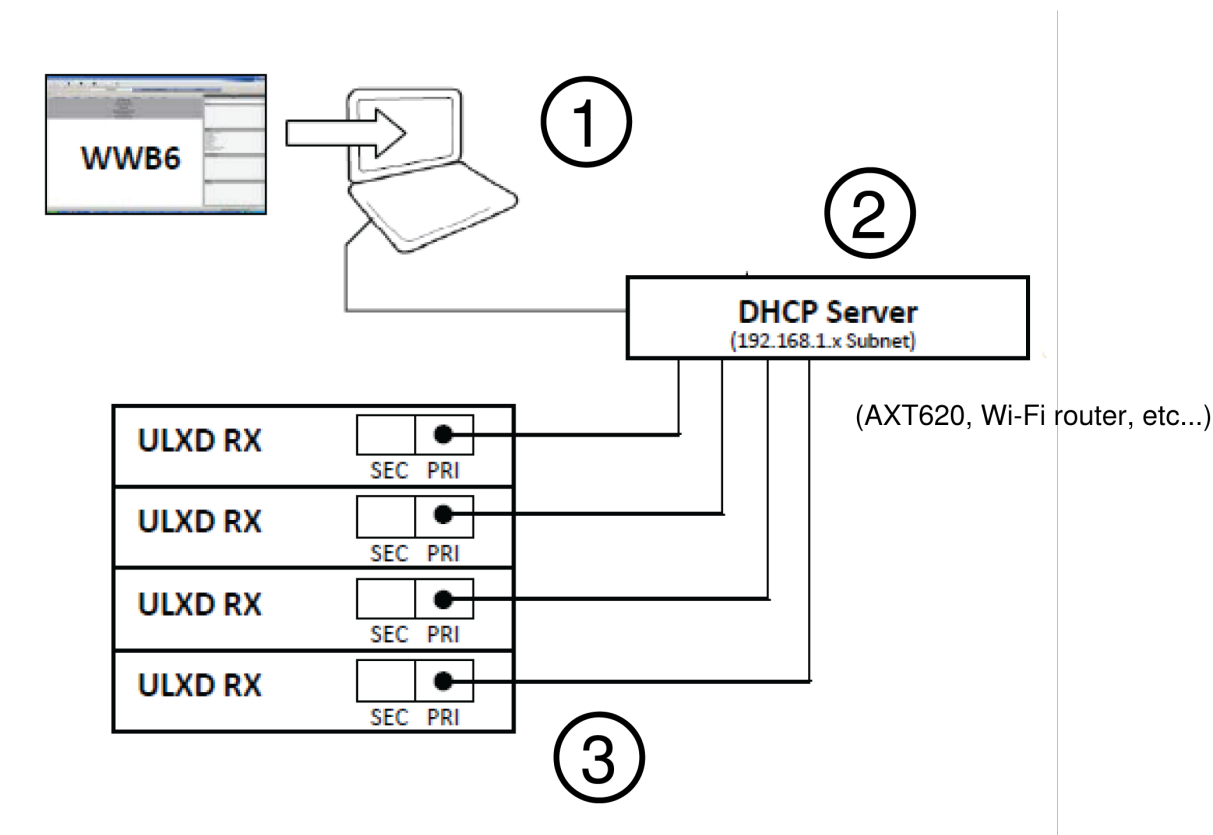

Redundant Audio Mode

Use Redundant mode to carry a backup copy of the Dante audio on the Secondary network in case the audio on the primary network is interrupted.

Network Characteristics:

- Dante Primary Audio and Shure Control are present on the Primary port
- Backup Dante audio is present on the Secondary port
- The Primary Dante IP address and the Shure Control IP address must be on the same subnet. The computer running WWB6 must also be on this subnet.
- The Secondary Dante IP Address must be set to a different subnet

Note: Devices connected to the Redundant network must be compatible with Redundant audio.

Network Example

① Computer

Connect the computer running the Dante controller and WWB6 to the Primary port.

② DHCP Server

Can be configured with or without a DHCP server. Do not route audio through the server.

③ Gigabit Ethernet Switches

- Use dedicated switches for the Primary and Secondary networks

- Do not connect both network ports to the same Ethernet switch
- Use a star network topology to minimize audio latency

④ Receiver Connection

Connect Primary and Secondary ports to dedicated switches.

Note: The Secondary port only supports manual IP or automatic Link-Local configuration. The Link-Local Dante Secondary address subnet is preset to 172.31.x.x (255.255.0.0)

⑤ Dante Receiver

Connect Dante receivers (mixers, recorders, amplifiers) to the Primary or Secondary ports.

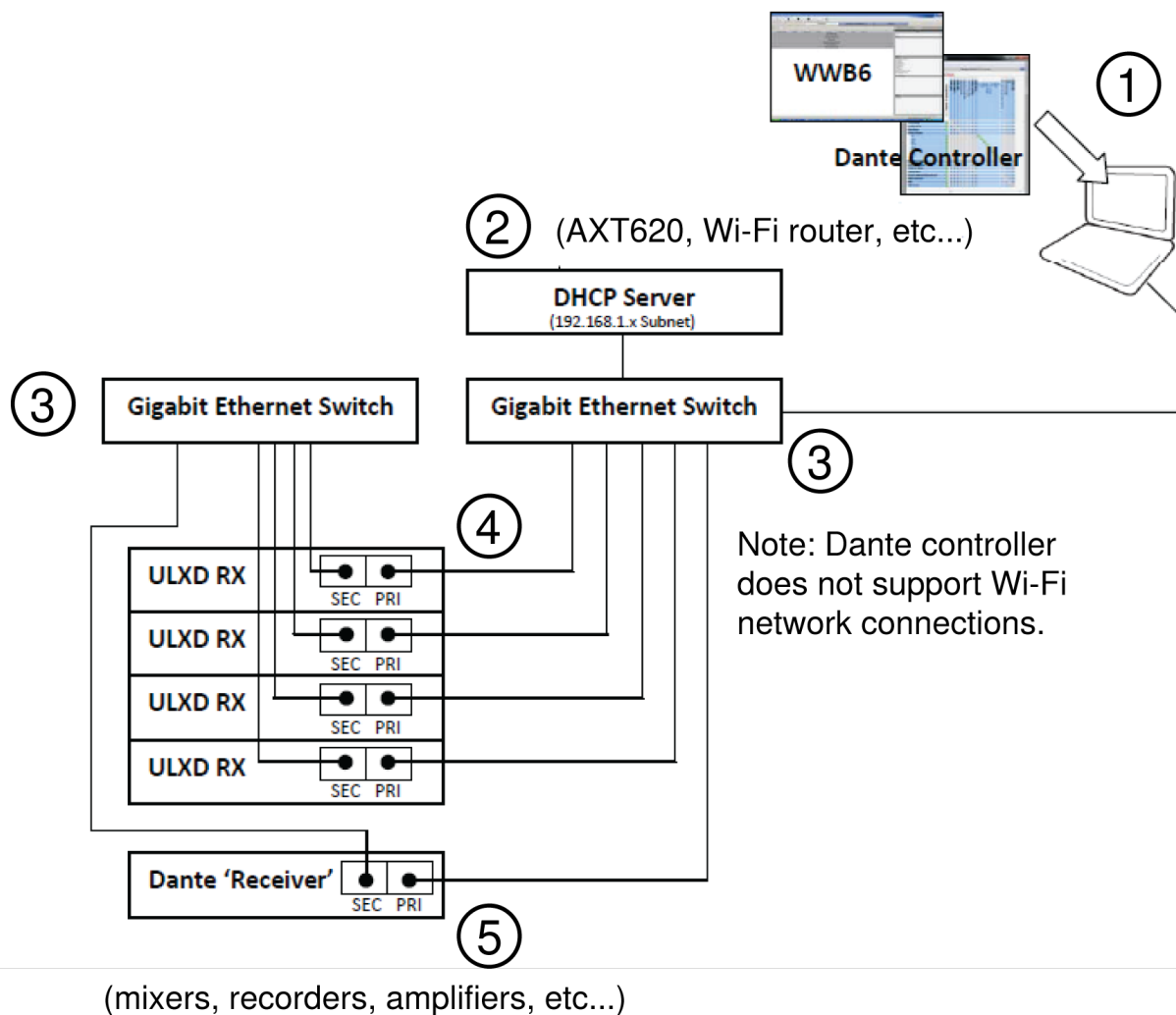

Split Mode

Use Split Mode to isolate control signals from audio signals by placing them on two separate networks.

Network Characteristics:

- Shure Control is present on the Primary port
- Dante Audio is present on the Secondary port
- The IP addresses for Dante and Shure Control must be on different subnets

Network Example

① Computer (Dante Controller)

Connect the computer running the Dante controller to the Secondary port.

② DHCP Server (Secondary Network)

Can be configured with or without a DHCP server. Do not route audio through the server.

③ Gigabit Ethernet Switch (Secondary Network)

- Use dedicated switches for the Primary and Secondary networks
- Do not connect both network ports to the same Ethernet switch
- Use a star network topology to minimize audio latency

④ Receiver Connections (Dante Audio)

Connect the Secondary ports to the Secondary network switch.

⑤ Computer (Shure Control)

Connect the computer running the Shure Control to the Primary port.

⑥ DHCP Server (Primary Network)

Can be configured with or without a DHCP server. Do not route audio through the server.

⑦ Gigabit Ethernet Switch (Primary Network)

- Use dedicated switches for the Primary and Secondary networks
- Do not connect both network ports to the same Ethernet switch
- Use a star network topology to minimize audio latency

⑧ Receiver Connections (Shure Control)

Connect the Primary ports to the Primary network switch.

⑨ Dante Receiver

Connect Dante receivers (mixers, recorders, amplifiers) to the Primary port.

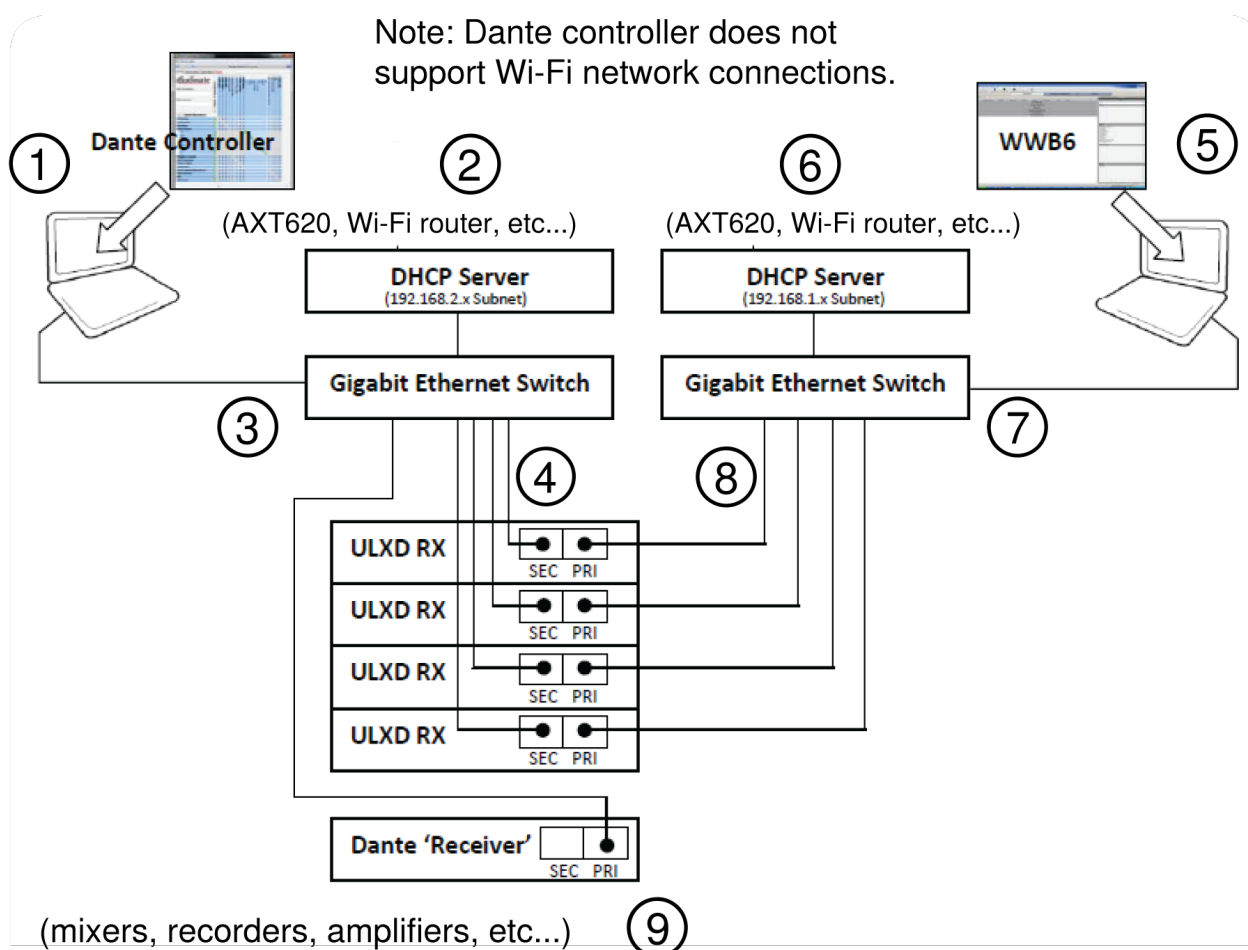

Assigning Network Device IDs for Shure Control and Dante Control

When using the receiver in a network with Shure Control (WWB6) and a Dante Controller, two Device IDs are required: one for Shure Control and one for Dante Control. Device IDs are used to identify devices on the network and for creating Dante digital audio routes.

Best Practices

Using the following best practices will help to organize network setup and ease troubleshooting.

- For consistency, convenience, and easy troubleshooting, use the same device ID for both WWB6 (Shure Control) and for the Dante network.
- The Dante network requires unique Dante device IDs to prevent a loss of audio signal routing. Any duplicate IDs on the network will be tagged with a number such as -1, -2, -3, etc.... and must be changed to a unique value.
- WWB6 (Shure Control) does not require unique device IDs and duplicates do not affect the Dante network; however, a best practice is to use unique device IDs.

Setting the Shure Control Device ID

1. Launch WWB6.
2. Open the Inventory View.
3. Click on the Device ID to enable editing.

Tip: Click on the device icon next to the channel name to identify the receiver using the Flash function.

Optionally, the Shure Control Device ID can be entered from the receiver front panel:

1. From the receiver menu: *DEVICE UTILITIES > NETWORK > SHURE CONTROL > Dev. ID*
2. Use the control wheel to edit the ID.
3. Press *ENTER* to save.

Creating a Dante Device ID

There are two ways to create a Dante ID:

1. Enter the ID using the receiver menu.
2. Enter the ID using a keyboard from the Dante controller.

If entering IDs from the receiver menu, additional ID modes are available for quickly adding sequential numbering to multiple receivers or adding a prefixes for network discovery by Dante enabled Yamaha mixing consoles.

Note: Changing the Dante ID will cause a loss of audio signal. After an ID has been changed, use the Dante controller to restore audio route subscriptions using the new ID.

Setting the Device ID from the receiver menu:

1. *DEVICE UTILITIES > NETWORK > DANTE > Dev. ID*
2. Use the control wheel to select an *ID MODE*:
 - *Off*: Manually enter an ID by using the control wheel. Press *ENTER* to save.
 - *Sequential*: Adds a 3-digit numerical prefix to the receiver model name to create the device ID. (ex: *001-Shure-ULXD*). Use the control wheel to increment the prefix value. Press *ENTER* to save.
 - *Yamaha*: Adds a prefix starting with "Y" followed by 3-digits to the receiver model name to create a device ID that allows Dante enabled Yamaha mixing consoles to discover ULX-D receivers on a Dante network. (ex: *Y001-Shure-ULXD*). Use the control wheel to increment the prefix numerical value. Press *ENTER* to save.

Entering the Device ID from the Dante controller:

1. Open the *Device View* and select the receiver from the pulldown menu.
2. Click on the *Device Config* tab.
3. Enter the ID in the *Rename Device* box and press *ENTER*.

Viewing Dante Device IDs in the Dante Controller

Dante device IDs are displayed in the *Network View* window in the Dante Controller.

1. Launch the Dante controller and open the *Network View* window.
2. Verify that the Dante device IDs match the IDs entered in the receiver.

Identify Device Feature

The Dante controller's Identify Device feature flashes the front panel LEDs of a selected receiver to provide identification when multiple receivers are in use.

Open the *Device View* in the Dante controller and click on the identify icon (eye). The front panel LEDs of the selected receiver will respond by flashing.

Configuring Audio Routes with the Dante Controller

Devices that appear in the Dante controller are categorized as "Transmitters" and "Receivers"

In order for audio to flow in the network, audio routes (subscriptions) must be configured between transmitters and receivers.

Note: *ULX-D* receivers will appear in the Dante controller as a Transmitter. Devices that have both inputs and outputs commonly appear as both transmitters and receivers.

Dante Transmitters

Devices that send or add audio into the network such as:

- Receiver Outputs
- Amplifier Outputs
- Mixer Outputs
- Signal Processor Outputs
- Recorder Playback Outputs



Dante Receivers

Devices that receive audio from the network such as:

- Amplifier Inputs
- Mixer Inputs
- Signal Processor Inputs
- Recorder Inputs

Forming an Audio Route

Launch the Dante Controller and click on the intersection point between components to form an audio route. The audio route is also referred to as a Subscription.

1. Find the intersection between the transmitter and receiver channels.
2. Click on the  where the components meet.
3. A green checkmark  indicates that the audio route has been established.
4. Check the audio to verify that the audio route has been formed.

For additional information about the Dante controller, visit www.audinate.com.

Click to expand this Dante device to view its Tx channels

Enter text to show only those Dante devices and channels containing that text

Click to expand all Dante devices and view all Rx channels

Click to collapse the Dante device Rx channel view

Click while holding the Ctrl key to subscribe to all possible channels at the same time.

Click to expand all Dante device and view all Tx channels

Network Troubleshooting

- Use only one DHCP server per network
- All devices must share the same subnet mask
- All receivers must have the same level of firmware revision installed
- Look for the illuminated network icon on the front panel of each device:

If the icon is not illuminated, check the cable connection and the LEDs on the network jack.

If the LEDs are not on and the cable is plugged in, replace the cable and recheck the LEDs and network icon.

To check connectivity of WWB6 to the network:

1. Start WWB6 software and use Inventory view to see devices connected to the network.
2. If not, find the IP address from one of the devices on the network (such as a ULX-D receiver) and see if you can ping it from the computer running WWB6.
3. From a WINDOWS/MAC command prompt, type 'ping IPADDRESS' of the device (e.g. "ping 192.168.1.100").
4. If the ping returns success (no packet loss), then the computer can see the device on the network. If the ping returns failure (100% packet loss), then check the IP address of the computer to ensure it's on the same subnet.
5. If the pings are successful and the devices still do not show up in the WWB6 inventory, check to ensure all firewalls are either disabled or allow the WWB network traffic to pass to the application. Check that firewall settings are not blocking network access.

Restoring Dante Factory Settings

The receiver and the Dante network card can be reset to restore factory Dante settings. Performing a reset is helpful for clearing existing data before setting up a system.

Caution! Performing a reset on either the Dante network card or on the ULX-D receiver will interrupt the Dante audio.

Tip: Prior to performing a factory reset, note the current Dante network mode and IP settings. After a reset, the Dante network mode reverts to *SWITCHED*, and the IP address mode revert to *AUTO*.

Restoring Receiver and Dante Card Factory Settings

Performing a reset from the receiver restores the factory settings and configures the Shure Control and Dante IP address mode to *AUTO*.

1. From the receiver menu: *DEVICE UTILITIES > SYSTEM RESET > RESTORE DEFAULT SETTINGS*
2. Press *ENTER* to complete the reset.

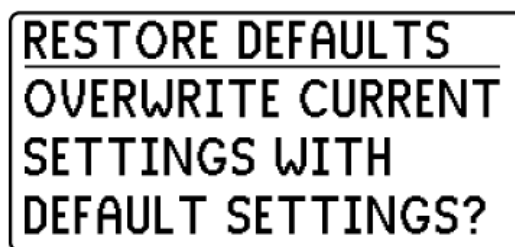
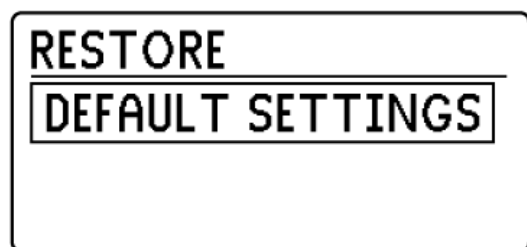

Restoring the Dante Network Card Factory Settings

The *Factory Reset* option within the Dante controller restores the Dante card to the factory settings and configures the Dante IP address mode to AUTO.

1. From the Dante controller, select a receiver and open the *Network Config* tab.
2. Click on *Factory Reset*.
3. Allow the Dante controller to refresh before making any additional changes.

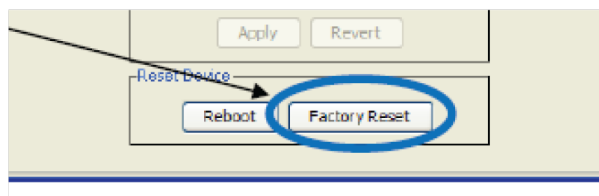

System Reset

System Reset clears the current receiver settings and restores the factory default settings.

To restore factory default settings:

1. Go to *DEVICE UTILITIES > SYSTEM RESET > RESTORE*.
2. Scroll to the *DEFAULT SETTINGS* option and press *ENTER*.
3. Press the flashing *ENTER* button to return the receiver to the default settings.

Firmware

Firmware is embedded software in each component that controls functionality. Periodically, new versions of firmware are developed to incorporate additional features and enhancements. To take advantage of design improvements, new versions of the firmware can be uploaded and installed using the Shure Update Utility tool available in Shure's Wireless Workbench[®] software. Software is available for download from <http://www.shure.com/wwb>.

Firmware Versioning

When updating receiver firmware, update transmitters to the same firmware version to ensure consistent operation.

The firmware of all ULX-D devices has the form of MAJOR.MINOR.PATCH (e.g., 1.2.14). At a minimum, all ULX-D devices on the network (including transmitters), must have the same MAJOR and MINOR firmware version numbers (e.g., 1.2.x).

Updating the Receiver

CAUTION! Ensure that receiver power and network connections are maintained during a firmware update. Do not turn off the receiver until the update is complete.

Once the download is complete, the receiver automatically begins the firmware update, which overwrites the existing firmware.

1. From Shure Wireless Workbench software, open the Shure Update Utility: *Tools > Shure Update Utility*.
2. Click the update button (for example, *5 Updates Available*) to view new firmware versions available to download.

3. Select the updates and click *Download*. The new downloads are added to the *Firmware* tab, making them available to install on the device hardware.
4. Connect the receiver and computer to the same network.
5. From the *Update Devices* tab, download the latest firmware to the receiver.

For more information on the Shure Update Utility, visit the [Shure Update Utility user guide](#).

Updating the Transmitter

1. To upload the firmware to the transmitter, go to *DEVICE UTILITIES > TXFWUPDATE* on the receiver.
2. Place the transmitter on its side and align the IR ports.
3. Press *ENTER* on the receiver to begin the download to the transmitter. IR ports must be aligned for the entire download, which can take 50 seconds or longer.

Connecting to an External Control System

The ULX-D receiver is compatible with external control systems such as AMX or Crestron via the Ethernet, using on the same cables used to carry Shure Control (WWB6). Use only one controller per system to avoid messaging conflicts.

- Connection: Ethernet (TCP/IP; ULX-D receiver is the client)
- Port: 2202

For a comprehensive list of ULX-D command strings, visit: http://shure.custhelp.com/app/answers/detail/a_id/4976

Setting the Gateway to Allow Cross Subnet Routing

ULX-D receivers include gateway addressing to support cross-subnet routing. The gateway setting allows a single controller to manage devices assigned to different subnets such as multiple rooms or multiple buildings.

Note: A gateway address is an advanced network setting. In most network configurations, the setting does not need to be changed.

To set the receiver gateway:

1. From the receiver menu: *DEVICE UTILITIES > NETWORK > SHURE CONTROL > NETWORK*
2. Press and turn the control wheel to set the *Mode* to *Manual*.
3. Press the control wheel to navigate to the first digit of the *GW* (gateway) setting.
4. Turn the control wheel to change a value, press the control wheel to advance to the next octet.
5. When finished, press *ENTER* to save.

Note: When setting the gateway address, the IP address and Subnet must be set to valid addresses.

Managing Your System with Shure Software

Wireless Workbench[®]

Manage every facet of wireless system performance, from pre-show planning to live channel monitoring, with Wireless Workbench.

- Visit [the Wireless Workbench page](#) to download Workbench.
- Visit [the Workbench help page](#) to learn how to use Workbench with your system.

ShurePlus™ Channels Application

Monitor the key elements of your wireless operation on a mobile device over Wi-Fi with ShurePlus Channels. Use alongside Wireless Workbench or as a stand-alone application for less complex coordination needs.

- Visit [the Channels page](#) to download ShurePlus Channels.
- Visit [the Channels user guide](#) to learn how to use Channels with your system.

Troubleshooting

Issue	See Solution...
No Sound	Power, Cables, Radio Frequency, or Encryption Mismatch
Faint sound or distortion	Gain
Lack of range, unwanted noise bursts, or dropouts	RF
Cannot turn transmitter off or change frequency settings, or can't program receiver	Interface locks
Encryption Mismatch message	Encryption Mismatch
Firmware Mismatch message	Firmware Mismatch
Antenna Fault message	RF

Power

Make sure that the receiver and transmitter are receiving sufficient voltage. Check the battery indicators and replace the transmitter batteries if necessary.

Gain

Adjust the system gain on the front of the receiver. Ensure the output level (XLR output only) on the back of the receiver corresponds to the input of the mixing console, amplifier, or DSP.

Cables

Check that all cables and connectors are working correctly.

Interface Locks

The transmitter and the receiver can be locked to prevent accidental or unauthorized changes. A locked feature or button will produce the *Locked* screen on the LCD panel.

Encryption Mismatch

Re-sync all receivers and transmitters after enabling or disabling encryption.

Firmware Mismatch

Paired transmitters and receivers must have the same firmware version installed to ensure consistent operation. See Firmware topic for firmware update procedure.

Radio Frequency (RF)

RF LEDs

If neither blue *RF* Diversity LED is illuminated, then the receiver is not detecting the presence of a transmitter.

The amber *RF* Signal Strength LEDs indicate the amount of RF power being received. This signal could be from the transmitter, **or it could be from an interfering source, such as a television broadcast**. If more than one or two of the amber *RF* LEDs are still illuminated while the transmitter is off, then that channel has too much interference, and you should try a different channel.

The red *RF* LED indicates RF overload. This will usually not cause a problem unless you are using more than one system at the same time, in which case, it can cause interference **in the other system**.

Compatibility

- Perform a Scan and Sync to ensure the transmitter and receiver are set to the same group and channel.
- Look at the label on the transmitter and receiver to make sure they are in the same band (G50, J50, L50, etc...).

Reducing Interference

- Perform a group or channel scan to find the best open frequency. Perform a sync to transfer the setting to the transmitter.
- For multiple systems, check that all systems are set to channels in the same group (systems in different bands do not need to be set to the same group).
- Maintain a line of sight between transmitter and receiver antennas.
- Move receiver antennas away from metal objects or other sources of RF interference (such as CD players, computers, digital effects, network switches, network cables and Personal Stereo Monitor (PSM) wireless systems).
- Eliminate RF overload (see below).

Increasing Range

If the transmitter is more than 6 to 60 m (20 to 200 ft) from the receiver antenna, you may be able to increase range by doing one of the following:

- Reduce interference (see above).
- Increase transmitter RF power level.
- Use Normal mode instead of High Density mode.
- Use an active directional antenna, antenna distribution system, or other antenna accessory to increase RF range.

Eliminating RF Overload

If you see the red RF LED on a receiver, try the following:

- Reduce the transmitter RF power level
- Move the transmitter further away from the receiver—at least 6 m (20 ft)
- If you are using active antennas, reduce antenna or amplifier gain.
- Use omnidirectional antennas

Antenna Faults

The *Antenna Fault* message indicates a short circuit condition at an antenna port.

- Check antennas and cables for damage
- Ensure that antenna ports are not overloaded
- Check antenna bias voltage setting. Turn off voltage if using passive antennas.

Accessories

Furnished Accessories

All Systems

Receiver	ULXD4D (Dual Receiver), ULXD4Q (Quad Receiver)
1/2-Wave Antenna (2)	Varies by band (see Antennas table for band-specific part numbers)
Hardware Kit (1)	90XN1371
2' BNC Cable (2)	95K2035
BNC Bulkhead Adapters (2)	95A8994
3' Ethernet Cable (1)	95B15103

Handheld Systems

Handheld Transmitter	ULXD2
Cartridge	see options below
Microphone Clip	95T9279
Zipper Bag	95B2313
AA Alkaline batteries (2)	80B8201
Battery Contact Cover	65A15947

Choice of one (1) of the following:

SM58	RPW112
SM86	RPW114
SM87A	RPW116
Beta 58A	RPW118
Beta 87A	RPW120

Beta 87C	RPW122
KSM8 Nickel	RPW170
KSM8 Black	RPW174
KSM9	RPW184
KSM9HS	RPW186

Bodypack System

Bodypack Transmitter	ULXD1
1/4-Wave Antenna	Varies by band (see Antennas table for band-specific part numbers)
Zipper Bag	95A2313
AA Alkaline batteries (2)	80B8201

Choice of one (1) of the following:

Instrument cable	WA302
Instrument Clip-on microphone	Beta 98H/C
Lavalier microphone	MX150, MX153, WL183, WL184, WL185
Headset microphone	WH30TQG
Instrument Cable 1/4" Right-Angle	WA304
Premium Instrument Cable	WA306
Premium 1/4" Right-Angle	WA307
LEMO to 1/4"	WA308
LEMO to 1/4" Right-Angle	WA309

Antennas

Band	1/2-Wave Receiver Antennas	1/4-Wave Transmitter Antennas
G50	95AA9279	95G9043 (Yellow)
G51	95AA9279	95G9043 (Yellow)
G52	95AA9279	95G9043 (Yellow)
H51	95AL9279	95D9043 (Gray)
H52	95AL9279	95D9043 (Gray)
J50	95AK9279	95E9043 (Black)

K51	95AJ9279	95E9043 (Black)
L50	95AD9279	95E9043 (Black)
L51	95AD9279	95E9043 (Black)
P51	95AF9279	95F9043 (Blue)
R51	95M9279	95F9043 (Blue)
AB	95M9279	N/A
Q51	95M9279	N/A

Optional Accessories

Shure Rechargeable Battery	SB900
8-Bay Battery Charger	SBC800
Dual Docking Battery Charger	SBC200
Boundary Transmitter	ULXD6
Gooseneck Base Transmitter	ULXD8
4-Bay Networked Charger for ULXD6 and ULXD8 Transmitters	SBC450
8-Bay Networked Charger for ULXD6 and ULXD8 Transmitters	SBC850
Carrying Case	WA610
Y-Cable for Bodypack Transmitters	AXT652
Active Antenna Splitter	UA845SWB
Passive Antenna Splitter/Combiner Kit	UA221
UHF Line Amplifier	UA830USTV
UHF Antenna Power Distribution Amplifier (U.S.A.)	UA844SWB
UHF Antenna Power Distribution Amplifier (Europe)	UA844SE
In-line Power Supply	UABIAST
Front Mount Antenna Kit (Includes 2 cables and 2 bulkhead	UA600
Remote Antenna Bracket with BNC Bulkhead Adapter	UA505
UHF Powered Directional Antenna	UA874WB
Passive Directional Antenna	PA805SWB
Coaxial Cable, BNC-BNC, RG58C/U type, 50 Ohm, 2 ft length (0.6 m)	UA802
Coaxial Cable, BNC-BNC, RG58C/U type, 50 Ohm, 6 ft length (2 m)	UA806
Coaxial Cable, BNC-BNC, RG8X/U type, 50 Ohm, 25 ft length (7.5 m)	UA825

Coaxial Cable, BNC-BNC, RG8X/U type, 50 Ohm, 50 ft length (15 m)	UA850
Coaxial Cable, BNC-BNC, RG213/U Type, 50 Ohm, 100 ft length (30 m)	UA8100
Black Bodypack Pouch	WA582B

Specifications

ULX-D System Specifications

RF Carrier Frequency Range

470–932 MHz, varies by region (See Frequency Range and Output Power table)

Working Range

100 m (330 ft)

Note: Actual range depends on RF signal absorption, reflection and interference.

RF Tuning Step Size

25 kHz, varies by region

Image Rejection

>70 dB, typical

RF Sensitivity

–98 dBm at 10^{-5} BER

Latency

<2.9 ms

Audio Frequency Response

ULXD1	20 – 20 kHz (± 1 dB)
ULXD2	Note: Dependent on microphone type

Audio Dynamic Range

A-weighted, typical, System Gain @ +10

XLR Analog Output	>120 dB
Dante Digital Output	130 dB

Total Harmonic Distortion

–12 dBFS input, System Gain @ +10

<0.1%

System Audio Polarity

Positive pressure on microphone diaphragm produces positive voltage on pin 2 (with respect to pin 3 of XLR output) and the tip of the 6.35 mm (1/4-inch) output.

Operating Temperature Range

-18°C (0°F) to 50°C (122°F)

Note: Battery characteristics may limit this range.

Storage Temperature Range

-29°C (-20°F) to 74°C (165°F)

Note: Battery characteristics may limit this range.

ULXD4D & ULXD4Q

Dimensions

44 x 482 x 274 mm H x W x D

Weight

ULXD4D	3.36 kg (7.4 lbs), without antennas
ULXD4Q	3.45 kg (7.6 lbs), without antennas

Housing

steel; Extruded Aluminum

ULXD4 Power Requirements

ULXD4D	100 to 240 V AC, 50-60 Hz, 0.26 A max.
ULXD4Q	100 to 240 V AC, 50-60 Hz, 0.32 A max.

RF Input

Spurious Rejection

>80 dB, typical

Connector Type

BNC

Impedance

50 Ω

Bias Voltage

12 to 13 V DC, 150 mA maximum, per antenna

switchable on-off

Cascade Output

Connector Type

BNC

Note: For connection of one additional receiver in the same band

Configuration

Unbalanced, passive

Impedance

50 Ω

Insertion Loss

0 dB

Audio Output

Gain Adjustment Range

-18 to +42 dB in 1 dB steps (plus Mute setting)

Configuration

XLR	balanced (1=ground, 2=audio +, 3=audio -)
------------	---

Impedance

100 Ω

Full Scale Output

LINE setting	+18 dBV
MIC setting	-12 dBV

Mic/Line Switch

30 dB pad

Phantom Power Protection

Yes

Networking

Network Interface

Dual Port Ethernet 10/100 Mbps, 1Gbps, Dante Digital Audio

Network Addressing Capability

DHCP or Manual IP address

Maximum Cable Length

100 m (328 ft)

ULXD1

Mic Offset Range

0 to 21 dB (in 3 dB steps)

Battery Type

Shure SB900 Rechargeable Li-Ion or LR6 AA batteries 1.5 V

Battery Runtime

@ 10 mW

Shure SB900	>9 hours
alkaline	9 hours

See Battery Runtime Chart

Dimensions

86 mm x 66 mm x 23 mm (3.4 in. x 2.6 in. x 0.9 in.) H x W x D

Weight

142 g (5.0 oz.), without batteries

Housing

Cast aluminum

Audio Input

Connector

4-Pin male mini connector (TA4M), See drawing for details

Configuration

Unbalanced

Impedance

1 M Ω , See drawing for details

Maximum Input Level

1 kHz at 1% THD

Pad Off	8.5 dBV (7.5 Vpp)
Pad On	20.5 dBV (30 Vpp)

Preamplifier Equivalent Input Noise (EIN)

System Gain Setting $\geq +20$

-120 dBV, A-weighted, typical

RF Output

Connector

SMA

Antenna Type

1/4 wave

Impedance50 Ω **Occupied Bandwidth**

<200 kHz

Modulation Type

Shure proprietary digital

Power

1 mW, 10 mW, 20 mW

See Frequency Range and Output Power table, varies by region

ULXD2

Mic Offset Range

0 to 21 dB (in 3 dB steps)

Battery Type

Shure SB900 Rechargeable Li-Ion or LR6 AA batteries 1.5 V

Battery Runtime

@ 10 mW

Shure SB900	>9 hours
alkaline	9 hours

See Battery Runtime Chart

Dimensions

VHF V50 and V51	278 mm x 51 mm (10.9 in. x 2.0 in.) L x Dia.
Other frequency bands	256 mm x 51 mm (10.1 in. x 2.0 in.) L x Dia.

Weight

VHF V50 and V51	348 g (12.3 oz.), without batteries
Other frequency bands	340 g (12.0 oz.), without batteries

Housing

Machined aluminum

Audio Input

Configuration

Unbalanced

Maximum Input Level

1 kHz at 1% THD

145 dB SPL (SM58), typical

Note: Dependent on microphone type

RF Output

Antenna Type

Integrated Single Band Helical

Occupied Bandwidth

<200 kHz

Modulation Type

Shure proprietary digital

Power

1 mW, 10 mW, 20 mW

See Frequency Range and Output Power table, varies by region

Tables and Diagrams

TA4M Connector

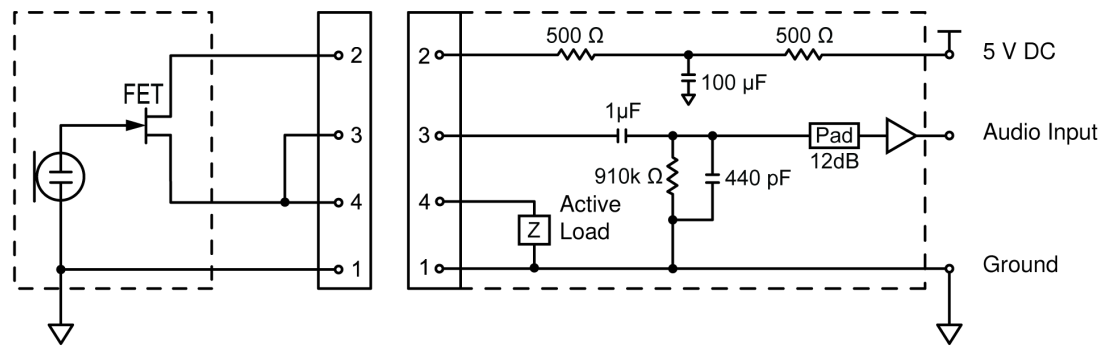

LEMO Connector

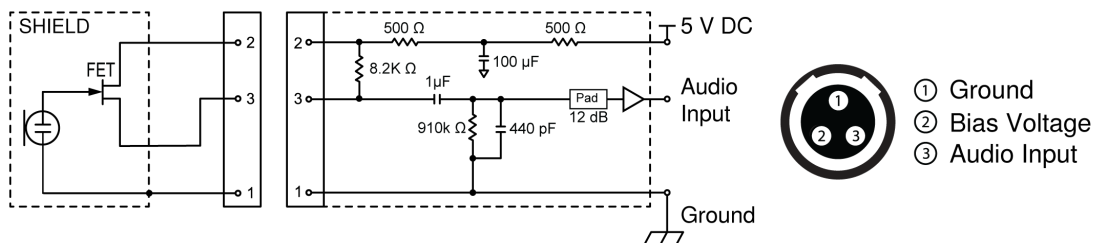

XLR to 1/4 Output

Use the following wiring diagram to convert the XLR output to a 1/4 output.

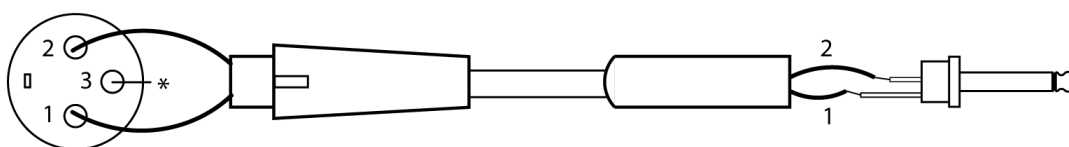

* No Connection

Batteries

ULXD Battery Life

ULXD	SB900A		alkaline	
	1/10 mW	20 mW	1/10 mW	20 mW
470 to 810	>9 hours	>6 hours	>8 hours	>5:30 hours
902 to 928	>8 hours	>5 hours	>7 hours	>4 hours
174 to 216	>9 hours	7 hours	8 hours	>5 hours
1240 to 1800	>8:30 hours	>6:30 hours	>6 hours	>4:30 hours

The values in this table are typical of fresh, high quality batteries. Battery runtime varies depending on the manufacturer and age of the battery.

Frequency Range and Transmitter Output Power

Band	Frequency Range (MHz)	Power (mW RMS)* (Lo/Nm/Hi)
G50	470 to 534	1/10/20
G51	470 to 534	1/10/20
G52	479 to 534	1/10

Band	Frequency Range (MHz)	Power (mW RMS)* (Lo/Nm/Hi)
G62	510 to 530	1/10/20
H50	534 to 598	1/10/20
H51	534 to 598	1/10/20
H52	534 to 565	1/10
J50	572 to 636	1/10/20
J50A Δ	572 to 608	1/10/20
J51	572 to 636	1/10/20
K51	606 to 670	1/10
L50	632 to 696	1/10/20
L51	632 to 696	1/10/20
L53	632 to 714	1/10/20
P51	710 to 782	1/10/20
R51	800 to 810	1/10/20
JB (Tx only)	806 to 810	1/10
AB (Rx and Tx)	770 to 810	'A' Band (770-805): 1/10/20
		'B' Band (806-809): 1/10
Q12	748 to 758	10/50
Q51	794 to 806	10
V50	174 to 216	1/10/20
V51	174 to 216	1/10/20
V52	174 to 210	10
X50	925 to 932	1/10
X51	925 to 937.5	10
X52	902 to 928	0.25/10/20
X53	902 to 907.500, 915 to 928	0.25/10/20
X54	915 to 928	0.25/10/20
Z16	1240 to 1260	1/10/20
Z17	1492 to 1525	1/10/20

Band	Frequency Range (MHz)	Power (mW RMS)* (Lo/Nm/Hi)
Z18	1785 to 1805	1/10/20
Z19	1785 to 1800	1/10/20
Z20	1790 to 1805	1/10/20

△ Output power limited to 10 mW above 608 MHz.

Note: Frequency bands might not be available for sale or authorized for use in all countries or regions.

* Power delivered to the antenna port

For the band Z17 (1492-1525 MHz), it must be used indoors only.

For the Band Z19 (1785-1800MHz) used in Australia, per Radio Communications Low Interference Potential Devices Class License 2015; item 30 note C: the system must be operated within the range of 1790-1800MHz when used outdoors.

低功率電波輻射性電機管理辦法

第十二條

經型式認證合格之低功率射頻電機，非經許可，公司、商號或使用者均不得擅自變更頻率、加大功率或變更原設計之特性及功能。第十四條

低功率射頻電機之使用不得影響飛航安全及干擾合法通信；經發現有干擾現象時，應立即停用，並改善至無干擾時方得繼續使用。前項合法通信，指依電信法規定作業之無線電通信。低功率射頻電機須忍受合法通信或工業、科學及醫療用電波輻射性電機設備之干擾。

Frequencies for European Countries

651 470–534 MHz

Country Code	Frequency Range
Code de Pays	Gamme de frequences
Codice di paese	Gamme di frequenza
Código de país	Gama de frecuencias
Länder-Kürzel	Frequenzbereich
A, B, BG, CH, CY, CZ, D, DK, EST, F	*
FIN, GB, GR, H, HR, I, IRL, IS, L, LT	*
M, N, NL, P, PL, RO, S, SK, SLO, TR	*
All other countries	*

* This equipment may be capable of operating on some frequencies not authorized in your region. See [Licensing Information](#).

H51 534-598 MHz

Country Code	Frequency Range
Code de Pays	Gamme de frequences
Codice di paese	Gamme di frequenza
Código de país	Gama de frecuencias
Länder-Kürzel	Frequenzbereich
A, B, BG, CH, CY, CZ, D, EST	534 - 598 MHz*
F, GB, GR, H, I, IS, L, LT	534 - 598 MHz*
NL, P, PL, S, SK, SLO	534 - 598 MHz*
DK, FIN, M, N	*
HR, E, IRL, LV, RO, TR	*
All other countries	*

* This equipment may be capable of operating on some frequencies not authorized in your region. See [Licensing Information](#).

K51 606-670 MHz

Country Code	Frequency Range
Code de Pays	Gamme de frequences
Codice di paese	Gamme di frequenza
Código de país	Gama de frecuencias
Länder-Kürzel	Frequenzbereich
A, B, BG, CH, CY, CZ, D, EST	606 - 670 MHz*
F, GB, GR, H, I, IS, L, LT	606 - 670 MHz*
NL, P, PL, S, SK, SLO	606 - 670 MHz*
RO	646 - 647; 654 - 655; 662 - 663 MHz*
DK, E, FIN, HR, IRL, LV, M, N, TR	*
All other countries	*

* This equipment may be capable of operating on some frequencies not authorized in your region. See [Licensing Information](#).

L52 632-694 MHz

Country Code	Frequency Range
Code de Pays	Gamme de frequences
Codice di paese	Gamme di frequenza
Código de país	Gama de frecuencias
Länder-Kürzel	Frequenzbereich
A, B, BG, CH, CY, CZ, D, DK, EST, F	*
FIN, GB, GR, H, HR, I, IRL, IS, L, LT	*
M, N, NL, P, PL, RO, S, SK, SLO, TR	*
All other countries	*

* This equipment may be capable of operating on some frequencies not authorized in your region. See [Licensing Information](#).

P51 710-782 MHz

Country Code	Frequency Range
Code de Pays	Gamme de frequences
Codice di paese	Gamme di frequenza
Código de país	Gama de frecuencias
Länder-Kürzel	Frequenzbereich
A, B, BG, CH, CY, CZ, D, EST, F, GB	710 - 782 MHz*
GR, H, I, IS, L, LT, NL, P, PL, S, SK, SLO	710 - 782 MHz*
RO	718 - 719; 726 - 727; 734 - 743; 750 - 751; 758 - 759 MHz*
DK, E, FIN, HR, IRL, LV, M, N, TR	*
All other countries	*

* This equipment may be capable of operating on some frequencies not authorized in your region. See [Licensing Information](#).

Q51 794-806 MHz

Country Code	Frequency Range
Code de Pays	Gamme de frequences
Codice di paese	Gamme di frequenza
Código de país	Gama de frecuencias
Länder-Kürzel	Frequenzbereich
A, B, BG, CH, CY, CZ, D, DK, E, EST	*
F, FIN, GB, GR, H, HR, I, IRL, IS, L, LT	*
LV, M, N, NL, P, PL, S, SK, SLO, TR	*
All other countries	*

* This equipment may be capable of operating on some frequencies not authorized in your region. See [Licensing Information](#).

R51 800-810 MHz

Country Code	Frequency Range
Code de Pays	Gamme de frequences
Codice di paese	Gamme di frequenza
Código de país	Gama de frecuencias
Länder-Kürzel	Frequenzbereich
N	800 - 810 MHz*
A, B, BG, CH, CY, CZ, D, DK, E, EST	*
F, FIN, GB, GR, H, HR, I, IRL, IS, L, LT	*
LV, M, N, NL, P, PL, S, SK, SLO, TR	*
All other countries	*

* This equipment may be capable of operating on some frequencies not authorized in your region. See [Licensing Information](#).

S50 823-832 MHz, 863-865 MHz

Country Code	Frequency Range
Code de Pays	Gamme de frequences
Codice di paese	Gamme di frequenza
Código de país	Gama de frecuencias
Länder-Kürzel	Frequenzbereich
D	license free
A, B, BG, CH, CY, CZ, D, DK, EST, F	*
FIN, GB, GR, H, HR, I, IRL, IS, L, LT	*
M, N, NL, P, PL, RO, S, SK, SLO, TR	*
863 - 865 MHz	EU: license free
All other countries	*

* This equipment may be capable of operating on some frequencies not authorized in your region. See [Licensing Information](#).

V51 174-216 MHz

Country Code	Frequency Range
Code de Pays	Gamme de frequences
Codice di paese	Gamme di frequenza
Código de país	Gama de frecuencias
Länder-Kürzel	Frequenzbereich
A, B, BG, CH, CY, CZ, D, DK, E, EST	*
F, FIN, GB, GR, H, HR, I, IRL, IS, L, LT	*
LV, M, N, NL, P, PL, S, SK, SLO, TR	*
All other countries	*

* This equipment may be capable of operating on some frequencies not authorized in your region. See [Licensing Information](#).

Z17 1492-1525 MHz

Country Code	Frequency Range
Code de Pays	Gamme de frequences
Codice di paese	Gamme di frequenza
Código de país	Gama de frecuencias
Länder-Kürzel	Frequenzbereich
A, B, BG, CH, CY, CZ, D, DK, E, EST	*
F, FIN, GB, GR, H, HR, I, IRL, IS, L, LT	*
LV, M, N, NL, P, PL, S, SK, SLO, TR	*
This Wireless microphone operates on the range of 1492-1525 MHz. Should be used INDOORS ONLY.	
All other countries	*

* This equipment may be capable of operating on some frequencies not authorized in your region. See [Licensing Information](#).

Z18 1785-1805 MHz

Country Code	Frequency Range
Code de Pays	Gamme de frequences
Codice di paese	Gamme di frequenza
Código de país	Gama de frecuencias
Länder-Kürzel	Frequenzbereich
A, B, BG, CH, CY, CZ, D, DK, E, EST	*
F, FIN, GB, GR, H, HR, I, IRL, IS, L, LT	*
LV, M, N, NL, P, PL, S, SK, SLO, TR	*
All other countries	*

* This equipment may be capable of operating on some frequencies not authorized in your region. See [Licensing Information](#).

Certifications

Meets essential requirements of the following European Directives:

- WEEE Directive 2002/96/EC, as amended by 2008/34/EC
- RoHS Directive 2011/65/EU

Note: Please follow your regional recycling scheme for batteries and electronic waste

This product meets the Essential Requirements of all relevant European directives and is eligible for CE marking.

Hereby, Shure Incorporated declares that the radio equipment is in compliance with Directive 2014/53/EU. The full text of the EU declaration of conformity is available at the following internet address: <http://www.shure.com/europe/compliance>

Authorized European representative:

Shure Europe GmbH

Headquarters Europe, Middle East & Africa

Department: EMEA Approval

Jakob-Dieffenbacher-Str. 12

75031 Eppingen, Germany

Phone: +49-7262-92 49 0

Fax: +49-7262-92 49 11 4

Email: EMEAsupport@shure.de

Certified under FCC Part 15 and FCC Part 74.

Certified by ISED in Canada under RSS-102 and RSS-210.

IC: 616A-ULXD1 G50, 616A-ULXD1 H50, 616A-ULXD1 J50, 616A-ULXD1 L50; 616A-ULXD2 G50, 616A-ULXD2 H50, 616A-ULXD2 J50, 616A-ULXD2 L50, 616A-ULXD1G50S, 616A-ULXD1H50S, 616A-ULXD1J50AS, 616A-ULXD2G50S, 616A-ULXD2H50S, 616A-ULXD2J50AS.

FCC: DD4ULXD1G50, DD4ULXD1H50, DD4ULXD1J50, DD4ULXD1L50; DD4ULXD2G50, DD4ULXD2H50, DD4ULXD2J50, DD4ULXD2L50, DD4ULXD1-G50, DD4ULXD1-H50, DD4ULXD1-J50A, DD4ULXD1-X52, DD4ULXD2-G50, DD4ULXD2-H50, DD4ULXD2-J50A, DD4ULXD2-X52 .

IC: 616A-ULXD1X52, 616A-ULXD2X52

FCC: DD4ULXD1X52, DD4ULXD2X52

IC: 616A-ULXD1V50, 616A-ULXD2V50

FCC: DD4ULXD1V50, DD4ULXD2V50

***Note:** For transmitters operating in the V50 and V51 bands: nominal free space antenna gain at middle of the band is typically -6 dBi, and rolls off at the band edges an additional -4 dB.*

Approved under the Declaration of Conformity (DoC) provision of FCC Part 15.

Conforms to electrical safety requirements based on IEC 60065.

Information to the user

This device complies with part 15 of the FCC Rules. Operation is subject to the following two conditions:

1. This device may not cause harmful interference.
2. This device must accept any interference received, including interference that may cause undesired operation.

These limits are designed to provide reasonable protection against harmful interference in a residential installation. This equipment generates uses and can radiate radio frequency energy and, if not installed and used in accordance with the instructions, may cause harmful interference to radio communications. However, there is no guarantee that interference will not occur in a particular installation. If this equipment does cause harmful interference to radio or television reception, which can be determined by turning the equipment off and on, the user is encouraged to try to correct the interference by one or more of the following measures:

- Reorient or relocate the receiving antenna.
- Increase the separation between the equipment and the receiver.
- Connect the equipment to an outlet on a circuit different from that to which the receiver is connected.
- Consult the dealer or an experienced radio/TV technician for help.

This device operates on frequencies shared with other devices. Consult the Federal Communications Commission White Space Database Administration website to determine available channels in your area prior to operation.

No user-operated control of power, frequency, or other parameters are available beyond those specified in this operating manual.

Canada Warning for Wireless

This device operates on a no-protection, no-interference basis. Should the user seek to obtain protection from other radio services operating in the same TV bands, a radio licence is required. For further details, consult Innovation, Science and Economic Development Canada's document Client Procedures Circular CPC-2-1-28, Voluntary Licensing of Licence-Exempt Low-Power Radio Apparatus in the TV Bands.

Ce dispositif fonctionne selon un régime de non-brouillage et de non-protection. Si l'utilisateur devait chercher à obtenir une certaine protection contre d'autres services radio fonctionnant dans les mêmes bandes de télévision, une licence radio serait requise. Pour en savoir plus, veuillez consulter la Circulaire des procédures concernant les clients CPC-2-1-28, Délivrance de licences sur une base volontaire pour les appareils radio de faible puissance exempts de licence et exploités dans les bandes de télévision d'Innovation, Sciences et Développement économique Canada.

This device contains licence-exempt transmitter(s)/receiver(s) that comply with Innovation, Science and Economic Development Canada's licence-exempt RSS(s). Operation is subject to the following two conditions:

1. This device may not cause interference.
2. This device must accept any interference, including interference that may cause undesired operation of the device.

L'émetteur/récepteur exempt de licence contenu dans le présent appareil est conforme aux CNR d'Innovation, Sciences et Développement économique Canada applicables aux appareils radio exempts de licence. L'exploitation est autorisée aux deux conditions suivantes :

1. L'appareil ne doit pas produire de brouillage;
2. L'appareil doit accepter tout brouillage radioélectrique subi, même si le brouillage est susceptible d'en compromettre le fonctionnement.