

# Aivia IN

## A-MIP IN Installation and operation manual



# General Information

## Important

Read this instruction manual before installation and use of the Aivia. Read this section carefully and follow the instructions. The warranty does not apply to damage caused by failure to follow the instructions.

The Aivia PROTECTION is a wall-mounted protective enclosure used to house and shelter AEDs. The Aivia PROTECTION does not ensure inspection of the AED. The DISTRIBUTOR shall verify under its sole responsibility, and inform its own SUB-DISTRIBUTORS and USERS that it is their responsibility to verify the state of operation of the AED and its presence by ensuring regular on-site physical inspections. Depending on the options chosen, the Aivia PROTECTION triggers on-unit visual and audible alarms. The alarm is specific information that's active only during the anomaly; no anomaly history is recorded. Under no circumstances shall the operating status and presence of AEDs housed in the Aivia PROTECTION be verifiable remotely. The Aivia can in no way replace the inspections and checks recommended by the manufacturer of the defibrillator.

Installation must be performed by a qualified technician or a technician authorized by the manufacturer of the Aivia.

Never install the Aivia where it will be directly exposed to sunlight. The unheated Aivia must be installed in a temperate environment in accordance with the defibrillator manufacturer's specifications. The heated Aivia must be installed in an environment that respects the operating temperatures of the Aivia. You must follow up on temperature alerts.

The Aivia's features are subject to change without prior notice.

The Aivia's manufacturer reserves the right to modify its products at any time without the obligation to modify previously delivered products.

Aivia is a registered trademark.

## Safety

To avoid all risk of fire or electric shock, no open flame should be placed near the Aivia.

Leave a space of at least 13 cm all around the Aivia to ensure proper ventilation.

Keep the Aivia away from radiators and other heat sources. Please do not place the Aivia on other appliances that heat up. Do not place anything under the Aivia.

To avoid damage, do not insert any objects into the openings.

Never install the Aivia where it'll be directly exposed to sunlight.

Do not expose the Aivia to water when the door is open.

Fasteners must be suitable for the type of support on which the Aivia is mounted. The manufacturer cannot be held responsible in the event of improper mounting or in the event of accident or injury during mounting.

## Warranty

Do not dismantle any of the Aivia's components. Do not insert any objects into the openings.

Only authorised personnel are allowed to perform repairs on the Aivia.

Failure to follow the instructions will void all warranties, express or implied.

Any operation expressly prohibited or any assembly procedure not recommended in this manual will void the warranty.

## Environmental Information

In the event you need to return the Aivia, all the original packaging must be used.

Do not dispose of the Aivia and its packaging with your household waste. Use the collection system in place in your area. The use of collection systems helps protect the environment in addition to your health. The Aivia comes equipped with batteries that comply with European Directives 2006/66/EC and 2008/103/EC. These cannot be disposed of along with regular household waste. Please enquire about the battery collection system in place in your area. The correct disposal of used batteries helps protect the environment in addition to your health.



## Maintenance

### ATTENTION

**THE AIVIA CONTAINS BATTERIES. THERE'S A RISK OF EXPLOSION IF THE AIVIA'S BATTERIES ARE REPLACED WITH THE INCORRECT TYPE OF BATTERIES.**

**ONLY AN AUTHORISED TECHNICIAN IS ALLOWED TO PERFORM MAINTENANCE OPERATIONS, ESPECIALLY WITH RESPECT TO REPLACING THE BATTERIES.**

# Table of Contents

---

---

## Installation

<b>Important</b>	<b>4</b>
Presentation of the Aivia	4
Identificationlabel	4
Initial opening	4
Installing the Aivia	5
Inserting the batteries into the Aivia	6
Inserting the defibrillator	7
Installing the seals	7
Pictograms	7

---

## Usage

Operation of the alerts	8
Use of the Aivia	8
After using the defibrillator	8

---

## Troubleshooting

**9**

---

## Specifications

Mechanical characteristics	10
Technical characteristics	10
Compliance	10

# Installation

## Important

Read these instructions carefully and completely before installing and using the Aivia..

**Never install the Aivia where it is exposed to direct sunlight. You may expose the defibrillator to excessive temperatures.**

## Presentation of the Aivia

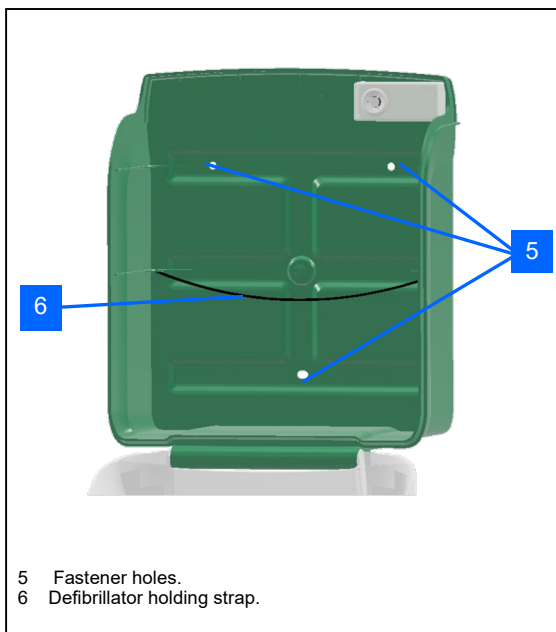
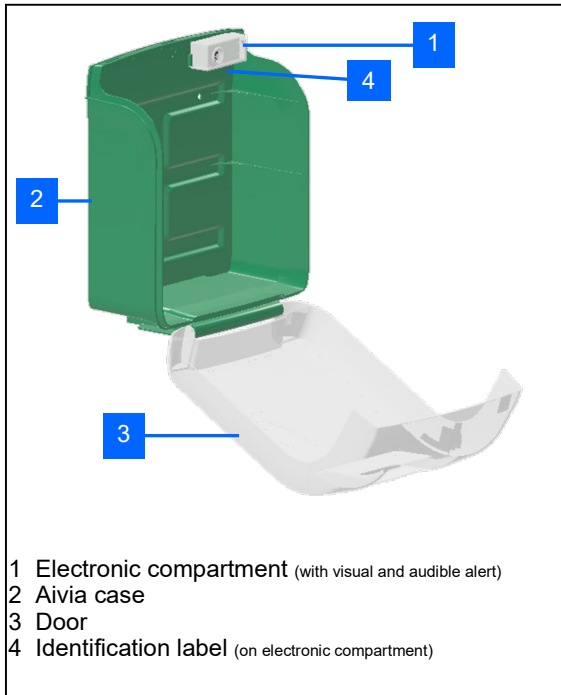

## Identification label

• The identification label is affixed to the inside of the Aivia.

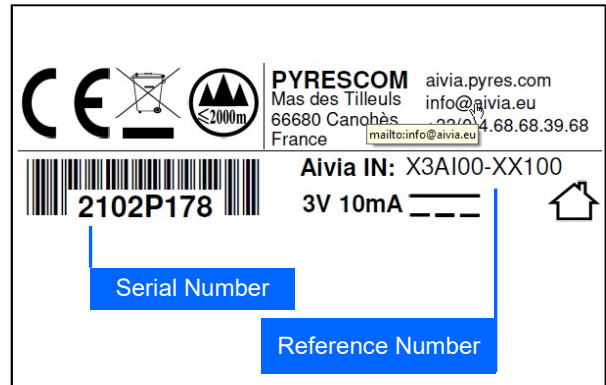

• For any correspondence with Customer Service or your service provider, please have the Aivia's reference number and serial number.

## Initial opening

• To open the Aivia IN before it's attached to the wall, hold the Aivia's case and push on both ends of the door.

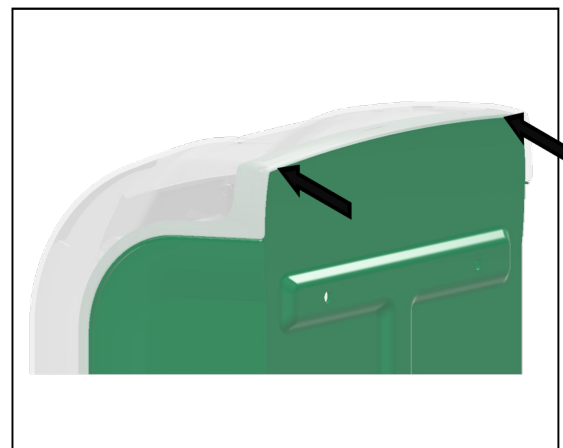

# Installation

## Installing the Aivia

**Never install the Aivia directly exposed to sunlight. The Aivia must be installed in a temperate environment in accordance with the defibrillator manufacturer's instructions.**

- Must be installed by a qualified technician or one authorised by the manufacturer of the Aivia and in adherence to the Bornavie Charter.
- If the Aivia is installed in a public area or passageway, provide a floor area (abutment) or a column to comply with the Order of 15 January 2007 "Technical requirements for free passageways" Article N°6-D.
- The fasteners must be appropriate for the type of support on which the Aivia is mounted.
- Leave free space for the Aivia as specified in the diagram below.
- The Aivia's specific dimensions are provided at the end of this document in the specifications section.

- Leave a space of 1.40 metres from the Aivia's wall bracket so that the door can be opened easily.

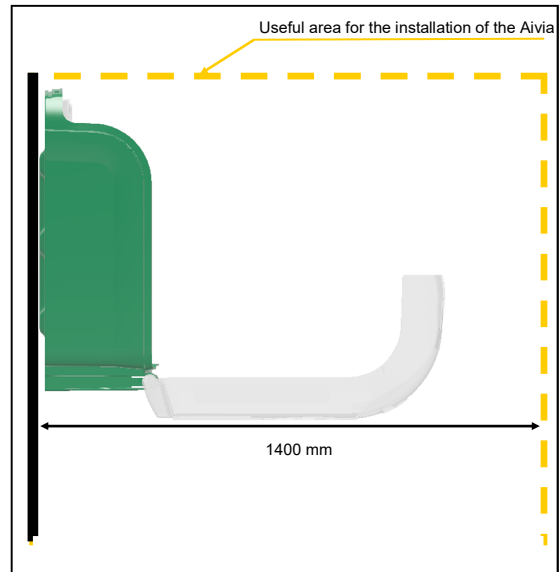

**Centreline mounting distance to be observed**

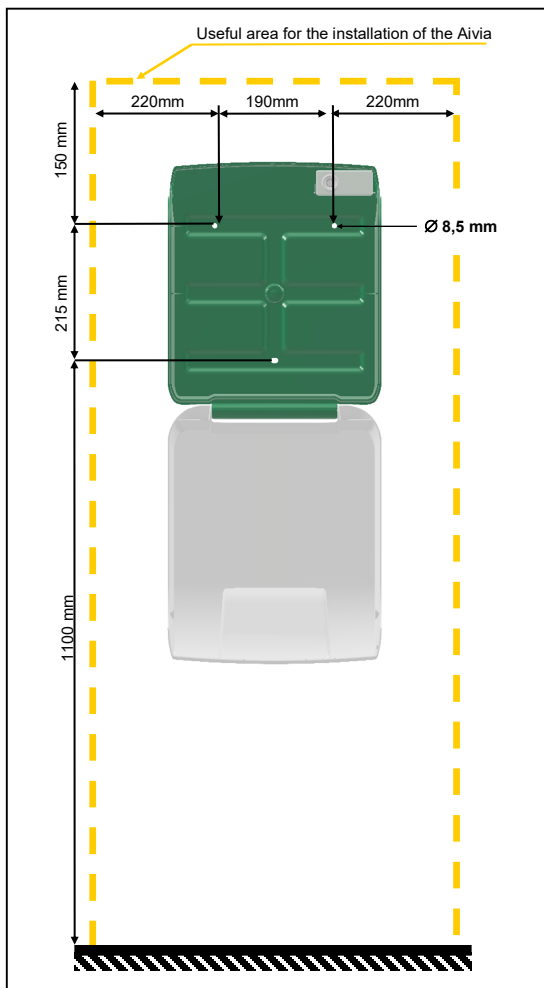

- The door can be unhooked to use the box as a mounting template.

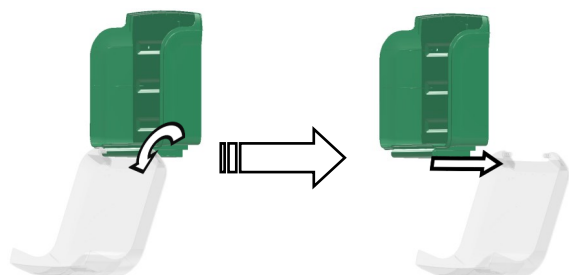

# Installation

- Use a mounting kit suitable for the type of support on which the Aivia is installed.
- The mounting must be able to withstand a minimum load of 20Kg.
- Mounting example:

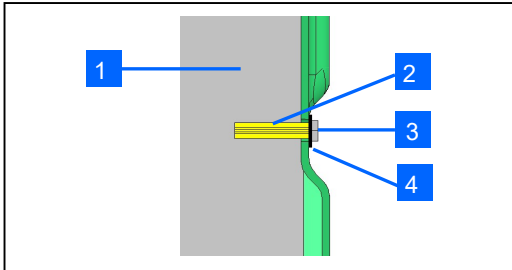

- 1 Support.
- 2 Wall plug.
- 3 Mounting screws: M6 minimum, M8 maximum.
- 4 Washer plate Ø 14mm maximum.

- The screw/washer assembly must not exceed a thickness of 8mm.

**Attach the Aivia via the three mounting holes.**

## Contents of the box



- Take out and open the box containing the additional items

## Additional items

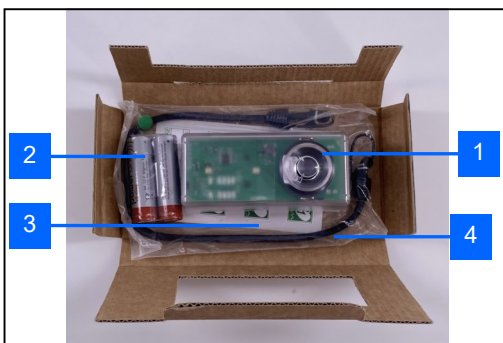

- 1 Electronics compartment (see page 6 for use)
- 2 AA batteries (see page 6 for use)
- 3 Seal labels (see page 7 for use)
- 4 Holding strap (see page 7 for use)

## Setting up the Aivia IN

- Place the 2 AA batteries in the electronic casing, observing the correct polarity.



- Clip the electronic compartment onto the box using an upward motion.



- Check that the Aivia is switched on when the door is closed.
- Alert lights blink red twice*



*The LEDs did not flash (see page 9)*

- The Aivia is operational.
- **When the door is opened, the visual and audible alarm will be activated for 30 seconds.**

# Installation

## Presentation of additional items

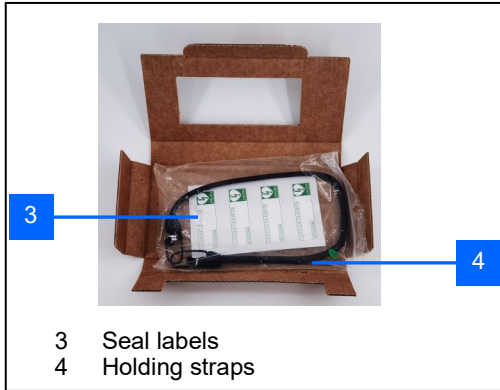

- Remove the protective film from the seal.

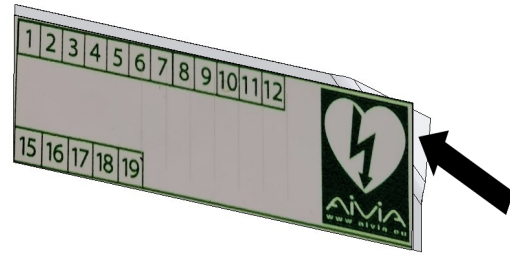

- Stick the seal across the Aivia's door and frame.

## Insertion of the defibrillator

- Hook the strap in the holes provided for this purpose.



- Pull the defibrillator holding strap and slide the defibrillator to the bottom of the Aivia.

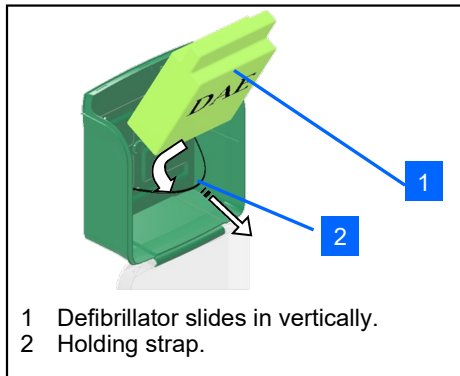

*The holding strap allows for easy removal in an emergency while holding the defibrillator in place.*



- Place one seal on each side of the Aivia.



## Installation of the seals

- The Aivia comes with two sets of seals.
- The seals alert you to the opening of the door.
- Regularly check the condition of the seals.

## Installation of the seals

- Close the Aivia's door completely. Make sure to pull the foot of the door towards you before rotating the door

- The surfaces of collage must be clean, dry, fat free.

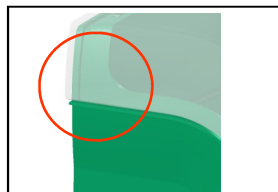

## Pictographs

- The signage on the door of the Aivia shows you what to do in case of emergency.
- Under SOS, you must include the number to call in case of emergency if it is not listed there.

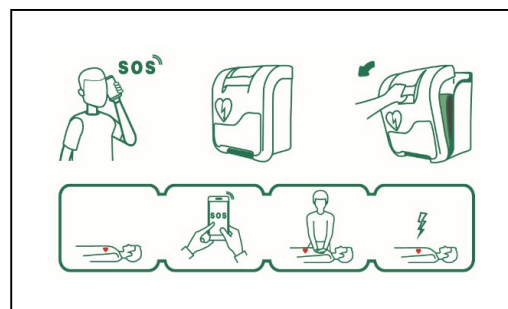

# Usage

## Operation of alerts

- Upon opening the door, a visual alert is given via the flashing of the red lights.
- The audible alarm is activated for 30 seconds when the door is opened.

## Use of the Aivia

If you witness an incident requiring the use of a defibrillator.

### • Contact emergency services.

Speak in a loud and clear voice, describe the situation and specify the location of the incident.



### • Pull on the Aivia's door to open it.

A visual alert is given via the flashing of the red lights. If your Aivia is equipped with an audible alarm, it's activated for 30 seconds).



### • Grasp the defibrillator.

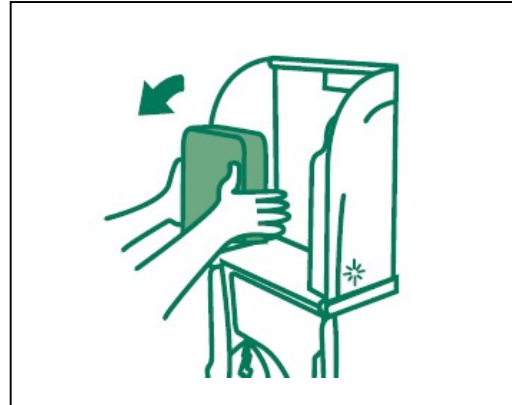

### • Approach the victim.

### • Activate the defibrillator.

### • Follow the defibrillator's instructions.

## After using the defibrillator

- Do not put the defibrillator back in the Aivia until it has been reactivated.
- Follow the instructions in the defibrillator's manual for putting it back into service.
- Your provider can help you put the defibrillator back into service. Please do not hesitate to contact him or her.
- When the defibrillator is back in service, install it in the Aivia following the instructions in the "Setting up the defibrillator" section.
- Install the seals by following the instructions in the "Installing the seals" section.

## Maintaining the Aivia

- Clean the surfaces of the Aivia with a soft, damp cloth. Wipe the Aivia with a clean, dry soft cloth. Do not use chemicals or cleaning products, as this could damage the Aivia.
- Do not rub the Aivia with a hard object, as this may scratch or permanently damage its surface.
- Do not use a high-pressure washer.
- Regularly check the condition of the seals.
- If the Aivia's seals have been compromised, make sure that all defibrillator components are present and in good working order. If in doubt, contact your defibrillator dealer.



# Troubleshooting

---

• The red LEDs do not light up when the batteries are inserted.

1. Check the battery insertion polarity.
2. Replace the batteries.
3. Contact your supplier.

• The red lights do not flash when I open the door.

1. Replace the batteries.
2. Contact your supplier.

• The alarm doesn't sound when I open the door.

1. Replace the batteries.
2. Contact your supplier.

Number of blinks	Cause	Solution
Every 20 secs	Dead batteries	Change the batteries.

# Specifications

## Mechanical characteristics

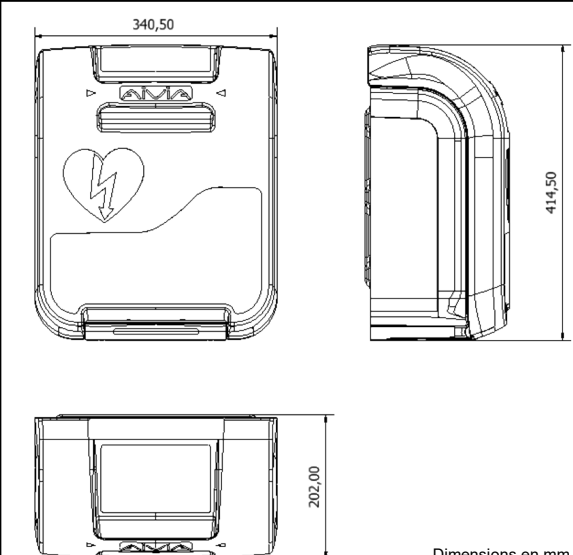

Dimensions en mm

**Weight:**

- Door: 825g
- Case: 988 g
- Electronic compartment: 97 g

**Materials:**

- Door: Polycarbonate.
- Case: ABS.
- Electronic compartment: Polycarbonate.

## Compliance

Electromagnetic compatibility  
Norme CISPR 32 : 2015  
Norme CISPR 35 : 2016

Norme FCC CFR Part 15 : 2020

Directive RoHS 2

## Technical characteristics

- Power supply:  
2 AA-LR6 Alkaline batteries
- Electrical consumption:  
Minimum: 0,8 mA.  
Maximum: 75 mA.  
Sound level: 90 dB / 1 metre.
- Autonomy :  
Greater than 1 year
- Operating temperatures and humidity:  
Minimum temperature: 0°C.  
Maximum temperature: 40°C.  
Relative humidity: 95% max with no condensation.
- Maximum weight supported: 5Kg.
- Maximum altitude: 2000m.



[aivia.pyres.com](http://aivia.pyres.com)

[info@aivia.eu](mailto:info@aivia.eu)

2021-02-18



A - M I P - I N - E N - 2 0 1