

# HEIDTS

HOT ROD & MUSCLE CAR PARTS



WILWOOD • IDIDIT • CURRIE • WELD



# INDEX

## Camaro: 1967-'81 & Nova: 1968-'79

- Coil-Overs .....13
- Control Arms .....13
- Disc Brakes .....13
- Independent Rear HEIDTS Pro-G® IRS System .....6
- Pro-G® Subframe .....4
- Rear 4-Link .....5
- Spindles, Dropped .....13
- Stabilizer Bar Kit.....13
- Right Hand Suspension Systems.....34

## Camaro/Firebird: 1982-'02

- 82-92 IRS .....8
- 82-92 Bolt On Parts.....10
- 93-02 Bolt On Parts .....11

## Chevy Chevelle & GM A-Body: 1964-'72

- Chassis Brace Links .....12
- Coil-Overs .....12
- Control Arms .....12
- Disc Brakes .....12
- Rear 4-Links.....12
- Spindles, Dropped .....12

## Mustang: 1964<sup>1/2</sup> -'70, Cougar: 1967-'68, Falcon: 1963-'65

- Brake Pedals .....15
- Chassis Stiffeners .....17
- Front HEIDTS Pro-G® Full Front Suspension System.....18
- HEIDTS Superide® .....16
- Independent Rear HEIDTS Pro-G® IRS System .....19
- Inner Fender Panels .....15

- Motor Mounts .....15,16
- Rear 4-Link Kit .....17
- Steering Kits.....15
- Subframe Connectors .....17
- HEIDTS Mustang II IFS Kit .....14
- Right Hand Suspension Systems.....34

## Fairlane & Comet: 1966-'67

- Rear 4-Link Kit .....21
- HEIDTS Superide® II .....20
- Right Hand Suspension Systems.....34

## Chevy Nova: 1962-'67 & 1968-'74

- Front Subframe .....22
- HEIDTS Superide® II .....23
- Front HEIDTS Pro-G® Full Front Suspension System.....24
- Independent Rear HEIDTS Pro-G® IRS System .....26
- Inner Fender Panels .....22,23,24
- Rear 4-Link Asmbly. ....25
- Stabilizer Bar Kit.....22,23,24
- Right Hand Suspension Systems.....34

## Nova: 1968-'74

- Front HEIDTS Pro-G® Full Front Suspension System....27
- Rear 4-Link .....28
- Independent Rear HEIDTS Pro-G® IRS System .....26

## Chevy: 1955-'57

- Coil-Overs .....29
- Control Arms .....29
- Disc Brakes .....30
- Rear 4-Link .....31
- HEIDTS PRO-G® IRS .....32
- Spindles, Dropped .....30
- Stabilizer Bar Kit.....29

## Right Hand Drive IFS Kits

- Right Hand Complete IFS Kits.....29

## HEIDTS SUPERIDE® IRS Systems .....36

### Complete Frames & Chassis

- Tri 5 Chevy Frame.....38
- '47-'54 Chevy Truck Frame.....39
- '32 Ford Car Frame.....40
- '33-'34 Ford Car Frame.....41
- '35-'40 Frame.....42
- '40-'41 Willy's Frame.....43
- Model A Frame.....44

### Mustang II

- Air Shock Suspension System .....50
- Control Arms .....49,50
- IFS Kits-Chevy, Ford, Multi-Fit .....45,46,47
- Replacement/Rebuild Parts .....73
- Right Hand Suspension Systems.....29
- Suspension Components .....48
- Tubular Strut Rods.....50

### SUPERIDE® IFS Systems

- Chevy: 1934-'35, most early systems .....51
- Ford: 1928-'34.....51
- Open Wheel (outboard & inboard shocks).....53
- Right Hand Suspension Systems.....34

### HEIDTS SUPERIDE® II IFS Systems

- Chevy: 1937-'39, Ford: 1935-'48.....55
- Chevy Pick-Up, 1947-'59 .....55
- Ford Pick-Up, '35-'41, Willy's: '37-'41 .....55
- Ford Pick-Up, '53-'56 .....55
- Right Hand Suspension Systems.....34

### Classic Trucks

- Chevy: 1955-'59 .....57
- Ford: 1953-'64.....57
- Right Hand Suspension Systems.....34

### Ford F-100: 1965-'72

- Heavy Duty Front Subframe Suspension System.....59
- Heavy Duty Rear 4-Link .....60

### Chevy C-10: 1967-'87

- Heavy Duty Front Subframe Suspension System.....61
- Heavy Duty Rear 4-Link .....62

### Street Rod & Classic Truck 4-Links .....63,64

### HEIDTS PRO-G® Universal IRS .....33

### Misc. Items

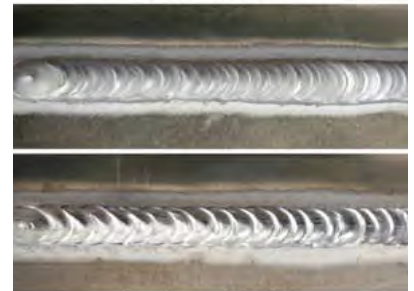
- Brake Calipers: Avail. Separately.....68
- Brake Line Fittings .....69
- Coil-Over Shocks .....65,66
- Column Hook-Up Kits.....71,72
- Disc Brakes & Brake Parts .....68,69
- Disc Brakes Conversion Kits.....67
- Motor Mounts .....70
- Panhard Bars .....64
- Power Steering Hose Kits.....72
- Power Steering Proportioning Valve .....72
- Proportioning Valves .....72
- Stabilizer Bars .....70
- Rear Disc Brake Kit .....67
- Spring Spacers.....73
- Stainless Brake Lines.....69
- Steering Columns.....71
- Steering Components.....72
- Toe Plates.....74

## Alston Racing Products

- Roll Bars & Cages.....75
- Roll Bar Accessories.....76
- Chassis, Snout Kits.....77,78
- Ladder Bar Frame.....79
- ProLink 4 Link.....79
- Fabricated Rear End.....80
- Racing Windows.....83,84
- Interior Kits.....85-91
- Understanding An IFS.....92
- Tech Tips.....94
- Installation Information.....95
- Questions/Answers .....99



AC TIG



Pulsed MIG





# NEW PRODUCTS IN THIS ISSUE

Part # IRC-401



1982-1992 & 1993-2002 Camaro/  
Firebird PRO-G IRS



'64-'70 Mustang PRO-G, Superide II and Musang II IFS. All new, completely redesigned for the Coyote motor and all Ford FE and Modular motors.



HEIDTS full frames!

## COMPARISON GUIDE TO HEIDTS® FRONT SUSPENSION SYSTEMS

**GOOD**



PAGE 46

**BETTER**



PAGE 54

**BEST**



HEIDTS PRO-G  
PAGE 77

**Mustang II**

**HEIDTS SuperRide® II**

**HEIDTS PRO-G®**

Upper Arm	T-Bolt Style	Heim-Style	Heim-Style
Shocks	Standard Spring and Shock	Adjustable Coil-Over Shocks	Adjustable Coil-Over Shocks
Crossmember	Single Crossmember	Single Crossmember	Double Crossmember
Brakes	GM Metric Caliper and Rotor	Wilwood Caliper and Granada Rotor	11" Full Wilwood Kit
Spindles	Mustang II Spindle Stock or Drop	Mustang II Spindle Stock or Drop	Heidts PRO-G® Spindle
Control Arm Thickness	7/8"	7/8"	1 1/4"
Geometry	Standard Geometry	Improved Geometry	Advanced Geometry



**Order/Tech: 800-841-8188**

# '67-69, '70-81 CAMARO/FIREBIRD

## HEIDTS PRO-G® FRONT SUBFRAME

LOWERS VEHICLE 2", 58 1/2" TRACK WIDTH



\*'70-'81 CAMARO SHOWN.  
Product is painted for catalog purposes only! All kits ship with Silver Powder Coated Springs - not shown.

\*Shown with upgrades.  
\*Air bags will not fit.

### INCLUDED IN BASE KIT:

- HEIDTS PRO-G® Subframe
- HEIDTS PRO-G® 2" Dropped Spindles
- Transmission X-Member
- Tubular Upper & Lower Arms
- Power Rack & Pinion Steering
- 11" Wilwood Brakes with Black Calipers
- Billet Coil-Over, Single Adjustable Shocks with Silver Powder Coated Springs

Now Available!  
Double Adjustable  
Shocks

### BRAKE OPTIONS

Description
11" Wilwood Smooth Rotors & 4 Piston Calipers (Black, Red, Chrome)
12" Wilwood Drilled Rotors & 4 Piston Calipers (Black, Red, Polished)
13" Wilwood Drilled Rotors & 6 Piston Calipers (Black, Red, Polished)

Additional options available. Call for pricing.

### SPINDLE

Description	Part#
2" Dropped Spindles	SP-110



### SHOCK & SPRING OPTIONS

Description	Part#
Single Adjustable Billet Coil-Over Shocks	CB-160
Double Adjustable Billet Coil-Over Shocks	CB-160-D
400#, 450#, 500#, 550# 600# Silver Powder Coated 10" Springs	CSV-XXX-10
Adjustable Spanner Wrench	TA-001
Thrust Bearings For Coil Over Shocks	CQ-010

### ADDITIONAL OPTIONS

Description	Part#
Upper Arm "Heim Style" Adjuster Kit	CF-104
1" Swaybar	SB-110
1-1/4" Swaybar	SB-111
1-1/4" Splined Swaybar	SB-401
67-69 Camaro/Firebird Subframe Connectors, Coupe	CF-107-WT
67-69 Camaro/Firebird Subframe Connectors, Convertible	CF-110-WT
67-69 Camaro/Firebird Drive Shaft Hoop (Subframe Connectors Required)	RC-037
70-81 Camaro/Firebird Subframe Connectors	CF-202-WT
70-81 Camaro/Firebird Drive Shaft Hoop (Subframe Connectors Required)	RC-125
Body Mount Kit Urethane Bushings	CF-106
Body Mount Kit Aluminum Bushings	CF-109
Motor Mount Stands	MM-220
LS Block Adapters Mounts (Urethane Mounts w/Adapters)	MM-200
Rubber Motor Mounts for Small Block Chevy	MM-120

HEIDTS® now offers their bolt on front subframe. Featuring their new Pro-G® suspension package for unbelievable cornering and overall handling. Simply unbolt and remove your front sheetmetal, engine/trans, old subframe, then slide in the new complete HEIDTS® Subframe. Reinstall your engine/trans and sheetmetal. HEIDTS® makes high end handling affordable!

### COMPLETE SUBFRAME BASE KIT

Description	Part#
67-69 Camaro/Firebird (Includes Trans Crossmember)	CF-101-WT
70-81 Camaro/Firebird (Includes Trans Crossmember)	CF-201-WT

### CONTROL ARM OPTIONS

Description	Part#	Add
Control Arms	CF-102	Included
Plain Control Arms 8" Adtl. Positive Caster (optional)	CF-102-8-H	Included
Polished Stainless Steel Control Arms	CF-103	Upgrade

### CONTROL ARM OPTIONS

Description	Part#	Add
Control Arms	CF-102	Included
Plain Control Arms 8" Adtl. Positive Caster (optional)	CF-102-8-H	Included
Polished Stainless Steel Control Arms	CF-103	Upgrade

### POWER RACK & PINION OPTIONS

Description	Part#	Add
Power Rack	MP-038-3-K	Included
Power Rack W/ Stainless Steel Tie Rod Ends	MP-038-SS-K	Upgrade



PACKAGES SHIP UNASSEMBLED VIA TRUCK FRIEGHT.

# 67-69, 70-81 CAMARO/FIREBIRD REAR 4-LINK

Bolt-on maximum performance for your Camaro or Firebird. Kit includes chassis and axle brackets, adjustable links, full upper coil-over crossmember, panhard bar, adjustable **HEIDTS**® coil-overs and all hardware. Completely bolt-on, with no cutting or floor modifications. Adjustable 4-link mounts allow suspension tuning.



## BOLT-IN REAR 4-LINK KIT



## LOWERS VEHICLE 2"

Product is painted for catalog purposes only! All kits ship with Silver Powder Coated Springs - not shown.

**PACKAGES SHIP UNASSEMBLED VIA TRUCK FREIGHT.**

### INCLUDED IN BASE KIT:

- 4-Links with Spherical Bearings and Axle Brackets
- Top Crossmember
- Panhard Bar
- Standard Coil-Over Shocks, Black Body and Black Springs

### COMPLETE 4-LINK BASE KIT

Description	Part#
67-69 Camaro/Firebird	RC-101-WT
67-69 Camaro/Firebird (Use If Ordering 9" Housing)	RC-101-WT-H
70-81 Camaro/Firebird	RC-121
70-81 Camaro/Firebird (Use if ordering Heidts 9" housing)	RC-121-H
74-81 Camaro/Firebird 4 Link	RC-126
70-73 Camaro/Firebird PRO-G 4 Link	RC-121-PG

### LINKS & PANHARD BAR OPTIONS

Description	Part#	
Plain Links and Panhard Bar	RC-106	Included
Polished Stainless Steel Links and Panhard Bar	RC-107	Upgrade

### SHOCK & SPRING OPTIONS

Description	Part#	
Black Coil-Over Shocks 250#, 300#, 350# Black Coil Springs	CO-101	Included
Billet Coil-Over Shocks 250#, 300#, 350# Silver Coil Springs	CB-105	Upgrade
Double Adjustable Billet Coil-Over Shocks	CB-105-D	Upgrade
Adjustable Spanner Wrench	TA-001	Upgrade
Thrust Bearings For Coil Over Shocks	CQ-010	Upgrade

### OPTIONAL AXLE HOUSING AND AXLE

Description	Part#
56" Track Width Housing With Brackets Installed	RC-040-56-H-WT
58" Track Width Housing With Brackets Installed	RC-040-58-H-WT
60" Track Width Housing With Brackets Installed	RC-040-60-H-WT
56" Track Width 31 Spline Axles with Chevy Bolt Pattern	RC-041-56-31
58" Track Width 31 Spline Axles with Chevy Bolt Pattern	RC-041-58-31
60" Track Width 31 Spline Axles with Chevy Bolt Pattern	RC-041-60-31

*'70-81 USE 60" TW '67-69 USE 56", 58" OR 60" TW*

### OPTIONAL 3RD MEMBER

Description	Part#
Positraction 31 Spline 3, 3.25, 3.50, 3.70, 3.90, 4.11 Ratio	BN-XXX-I-L

### OPTIONAL BRAKE OPTIONS

Description	
11" Heavy Duty Drum Brake	
12" Iron Rotors, GM Single Piston Calipers W/Parking Brake	
12" Wilwood Smooth Rotors & 4 Piston Calipers W/Parking Brake	Black, Red or Polished Calipers
12" Wilwood Drilled Rotors & 4 Piston Black Calipers W/Parking Brake	Black, Red or Polished Calipers

### OPTIONAL SUBFRAME CONNECTOR OPTIONS

Description	Part#
67-69 Camaro/Firebird Subframe Connectors- Coupe	CF-107-WT
67-69 Camaro/Firebird Subframe Connectors- Convertible	CF-110-WT
67-69 Camaro/Firebird Subframe Connectors - Coupe (Factory Subframe)	RC-102
67-69 Camaro/Firebird Subframe Connectors - Convertible (Factory Subframe)	RC-103
70-81 Camaro/Firebird Subframe Connectors (Factory)	RC-122
70-81 Camaro/Firebird Subframe Connectors (PRO-G®)	CF-202-WT

### ADDITIONAL OPTIONS

Description	Part#
67-69 Camaro/Firebird Drive Shaft Hoop (Subframe Connectors Req.)	RC-037
67-69 Camaro/Firebird Rear Swaybar	SB-009
70-81 Camaro/Firebird Rear Swaybar	SB-170
70-81 Camaro/Firebird Drive Shaft Hoop (Subframe Connectors Req.)	RC-125
70-81 Camaro/Firebird Subframe Connectors-Coupe (PRO-G®)	CF-202-WT
70-81 Camaro/70-81 Firebird Subframe Connectors (Factory)	RC-122



**Now Available!  
Double Adjustable  
Shocks**



HEIDTS CAMARO BOLT ON 4-LINK KIT

**Order/Tech: 800-841-8188**



'67-'69, '70-'73  
CAMARO/FIREBIRD



# HEIDTS PRO-G IRS

**HIGH HORSEPOWER INDEPENDENT REAR SUSPENSION**  
**58 1/2" TRACK WIDTH**

Product is painted for catalog purposes only! All kits ship with Silver Powder Coated Springs - not shown.



Available with cast aluminum center section or steel fabricated housing.

U.S. Patent No. D666,949 Additional Patents Pending



## WHY HEIDTS PRO-G® IRS

Do you really want to go fast and out-handle everyone else on the autocross or road race course in your first generation camaro? Full independent rear suspension is the only way to go. **HEIDTS®** now has a High Horsepower Independent Rear Suspension bolt-In Package that will do the job just fine.

*It is a true high horsepower package, with upper links and heavy duty CV joints. The upper link produces  $-.5^\circ$  of camber curve at 3/4 of total travel, especially during very high cornering loads. Forward struts, attached to the sub-frame connectors insures the wheels stay in place during hard acceleration.*

**“About once every ten years, someone comes up with a breakthrough part in the aftermarket. The HEIDTS® Bolt-in Independent Rear suspension could be that part for 2011 and beyond”**

Quoted from Jim Campisano – Editor  
Super Chevy Magazine, January Issue

## WHAT YOU GET:

- Track Width 58 1/2"
- 9" Aluminum HSG.
- 3rd Member, Iron, Posi
- CV Joint Halfshafts
- Tubular Upper & Lower Arms
- Steel Outer Uprights
- Top Crossmember
- Frame Mounting Brackets
- Front Pinion Support
- Forward Struts\*
- 10.5" Wilwood Rotors
- Black Wilwood Calipers
- Billet Single Adjustable Coil-Overs with Silver Powder Coated Springs
- Posi-Traction

**Now Available!**  
**Double Adjustable**  
**Shocks**

## OPTIONS: CALL FOR DETAILS.

- Choice of Gear Ratios
- Parking Brake Kit and Cable Kit

# '67-'69, '70-'73 CAMARO/FIREBIRD



## HEIDTS PRO-G IRS

### HIGH HORSEPOWER INDEPENDENT REAR SUSPENSION

**COMPLETE BASE KIT** (500HP and 800HP Options Available)

Description	Part#
67-69 Camaro/Firebird IRS, Plain Rotors	IRC-101
67-69 Camaro/Firebird IRS, Slotted Rotors	IRC-101-S
70-73 Camaro/Firebird IRS, Plain Rotors	IRC-201
70-73 Camaro/Firebird IRS, Slotted Rotors	IRC-201-S



Product is painted for catalog purposes only! All kits ship with Silver Powder Coated Springs - not shown.

**\*Subframe Connectors Included.**

#### SHOCK & SPRING OPTIONS

Description	Part#	
Single Adjustable Billet Coil-Over Shocks	CB-106	Included
Double Adjustable Billet Coil-Over Shocks	CB-106-D	Upgrade
350# Silver Powder Coated Springs	CSV-450-10	Included
400# Silver Powder Coated Springs	CSV-400-10	Included
450# Silver Powder Coated Springs	CSV-450-10	Included
550# Silver Powder Coated Springs	CSV-550-10	Included

#### 3RD MEMBER OPTIONS

Description	Part#	
Positraction 31 Spline 3.00 Ratio	BN-300-I-L	Included
Positraction 31 Spline 3.25 Ratio	BN-325-I-L	Included
Positraction 31 Spline 3.50 Ratio	BN-350-I-L	Included
Positraction 31 Spline 3.70 Ratio	BN-370-I-L	Included
Positraction 31 Spline 3.90 Ratio	BN-390-I-L	Included
Positraction 31 Spline 4.11 Ratio	BN-411-I-L	Included

#### SUBFRAME CONNECTORS FOR PRO-G®

SUBFRAME Description	Part#	
67-69 Camaro/Firebird Subframe Connectors - Coupe	CF-107-WT-RC	Included
67-69 Camaro/Firebird Subframe Connectors - Convertible	CF-110-WT-IRC	Included
70-73 Camaro/Firebird Subframe Connectors - Coupe	CF-202-WT-RC	Included

#### SUBFRAME CONNECTORS FOR FACTORY SUBFRAME

Description	Part#	
67-69 Camaro/Firebird Subframe Connectors - Coupe	RC-102-IRC	Included
67-69 Camaro/Firebird Subframe Connectors - Convertible	RC-103-IRC	Included
70-73 Camaro/Firebird Subframe Connectors	RC-122-IRC	Included

#### PARKING BRAKE OPTIONS

Description	Part#	
Parking Brake Kit & Cable Kit- Black	PB-101	Upgrade
E-Stop Actuator	BM-013	Upgrade
Parking Brake Kit- Silver	PB-101-S	Upgrade

#### HOUSING OPTIONS

Description	Part#	
Polished Aluminum 9" Housing	BM-001-P	Upgrade
Steel Fab 9" Housing	BT-410	Upgrade



PB-101



**Order/Tech: 800-841-8188**

**HEIDTS® MUSCLE CAR PARTS**

'82-'92, '93-'02 CAMARO/FIREBIRD

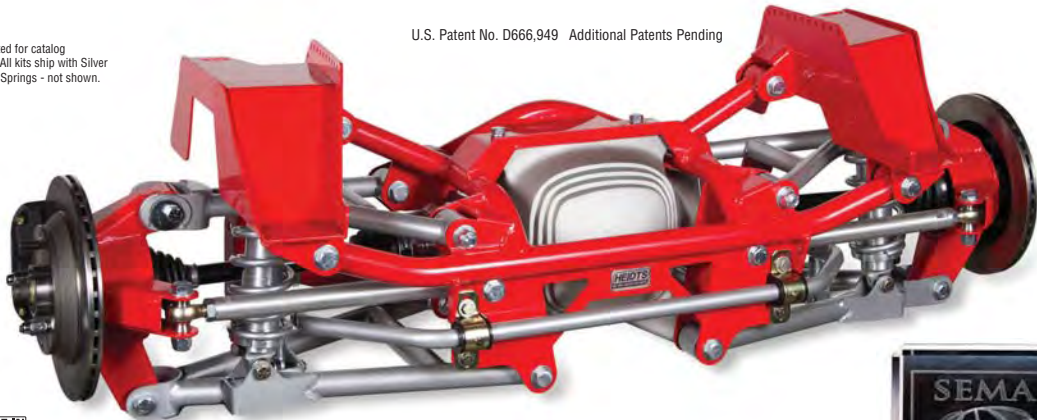


# HEIDTS PRO-G<sup>®</sup> IRS

## HIGH HORSEPOWER INDEPENDENT REAR SUSPENSION

Product is painted for catalog purposes only! All kits ship with Silver Powder Coated Springs - not shown.

U.S. Patent No. D666,949 Additional Patents Pending



2015 SEMA Global Media Award Winner  
Suspension Category



### WHY HEIDTS PRO-G<sup>®</sup> IRS

Do you really want to go fast and out-handle everyone else on the autocross or road race course in your 3rd generation camaro? Full independent rear suspension is the only way to go. HEIDTS<sup>®</sup> now has a High Horsepower Independent Rear Suspension bolt-In Package that will do the job.



### WHAT YOU GET:

- Track Width 62", 65"
- 9" Housing
- CV Joint Halfshafts
- Tubular Upper & Lower Arms
- Billet Adjustable Coil-Overs with Silver Powder Coated Springs
- Rear Steering Arm

### OPTIONS: CALL FOR DETAILS

- Choice of Gear Ratios
- Parking Brake Kit and Cable Kit
- Wilwood Brake Upgrades
- 3rd Member, Iron, Posi



# 3RD & 4TH GEN CAMARO/FIREBIRD

## HEIDTS PRO G IRS



Builder: The RestoMod Store

## HIGH HORSEPOWER INDEPENDENT REAR SUSPENSION

### COMPLETE BASE KIT (500HP and 800HP Options Available)

Description	Part#
82-92 Camaro/Firebird IRS	IRC-301
93-02 Camaro/Firebird IRS	IRC-401

### SHOCK & SPRING OPTIONS

Description	Part#	
Single Adjustable Billet Coil-Over Shocks	CB-105-G	Included
Double Adjustable Billet Coil-Over Shocks	CB-105-G-D	Upgrade
350# Silver Powder Coated Springs	CSV-350-10	Included
400# Silver Powder Coated Springs	CSV-400-10	Included
450# Silver Powder Coated Springs	CSV-450-10	Included
550# Silver Powder Coated Springs	CSV-550-10	Included



Product is painted for catalog purposes only! All kits ship with Silver Powder Coated Springs - not shown.



### 3RD MEMBER OPTIONS

Description	Part#	
Positraction 31 Spline 3.00 Ratio	BN-300-I-L	Upgrade
Positraction 31 Spline 3.25 Ratio	BN-325-I-L	Upgrade
Positraction 31 Spline 3.50 Ratio	BN-350-I-L	Upgrade
Positraction 31 Spline 3.70 Ratio	BN-370-I-L	Upgrade
Positraction 31 Spline 3.90 Ratio	BN-390-I-L	Upgrade
Positraction 31 Spline 4.11 Ratio	BN-411-I-L	Upgrade



### CV SHAFT OPTIONS

Description	Part#	
Standard Horsepower CV Shafts W/27 Spline Hubs 62"	IRC-127	Included
High Horsepower CV Shafts W/33 Spline Hubs 62"	IRC-126	Upgrade
Standard Horsepower CV Shafts W/27 Spline Hubs 65"	IRC-130	Included
High Horsepower CV Shafts W/33 Spline Hubs 65"	IRC-131	Upgrade

\*IRC-130 and IRC-131 also available with TCS sensors

### UPRIGHT OPTIONS

Description	Part#	
IRS Upright Kit With Bushings	IRC-331	Included
IRS Upright Kit With Spherical Bearings	IRC-332	Upgrade

### Swaybar Option

Description	Part#	
Sway Bar Kit, Rates 228-282-359 LB./INCH	SB-240	Upgrade



### BRAKE OPTIONS

Description	Part#	
C4 Caliper with Plain Rotors	DR-070	Upgrade
C4 Calipers with Wilwood Drilled and Slotted Rotors	DR-075	Upgrade
4 Piston Red Wilwood Calipers, Slotted Rotors, No Park Brake	DR-080-S-R	Upgrade
4 Piston Black Wilwood Calipers, Slotted Rotors, No Park Brake	DR-080-DS-B	Upgrade
4 Piston Red Wilwood Calipers, Slotted Rotors, Parking Calipers	DR-085-S-R	Upgrade
4 Piston Black Wilwood Calipers, Slotted Rotors, Parking Calipers	DR-085-DS-B	Upgrade



Order/Tech: 800-841-8188

# '82-'92 CAMARO/FIREBIRD

## BOLT-ON SUBFRAME CONNECTOR

No cutting or welding to install allowing you to retain your stock exhaust, fuel and brake lines. These connectors come complete with grade 8 hardware and instructions. They are powder coated black to insure long life and beauty. (they can also be welded)

Description	Part#
82-92 Camaro/Firebird Inner Subframe Connectors	AL-102411
82-92 Camaro/Firebird Outer Subframe Connectors	RC-536

## BOLT-ON REAR CONTROL ARMS

Genuine Energy Suspension bushings are used exclusively for a long life with low maintenance. Profile milled sway bar mounts. Powder coated gloss black for a long lasting beautiful finish.

Description	Part#
82-92 Camaro/Firebird Control Arms	401010
82-92 Camaro/Firebird Adjustable Control Arms	RC-551
3rd & 4th Gen Rear Coilover Conversion Kit (shocks, brackets, springs)	CO-107-XXX

## GM BOLT ON TORQUE ARM

Our BOLT ON TORQUE ARM features an 1/8" steel plate cradle that replaces the factory rubber mount. Our Torque Arm not only improves traction but significantly increases stability under deceleration. Our adjustable Torque Arm enables you to adjust the pinion angle.

Description	Part#
82-92 Camaro/Firebird Torque Arm	RC-588
82-92 Camaro/Firebird Torque Arm Axle Bracket	RC-609
82-92 F-Body Torque Arm kit (RC-588, RC-602, and RC-609)	RC-587

## GM PAN HARD BARS

Tubular design PAN HARD BARS replaces the factory u-channel style, providing more chassis stability. Energy Suspension bushings dramatically resist deflection keeping the housing centered and improving cornering ability

Description	Part#
82-02 Camaro/Firebird Non Adjustable	AL-401061
82-02 Camaro/Firebird- Adjustable	RC-561

## STRUT TOWER BRACES

Heidts FRONT STRUT TOWER BRACES tighten up the handling and control of the 3rd Gen Camaro and Firebird.

Description	Part#
2 Point Adjustable Strut Tower Brace, V6, V8 Tuneport	CF-370
3 Point Adjustable Strut Tower Brace, V6, V8 Tuneport	CF-371
Adjustable 2 Point Strut Tower Brace- 305 motor	CF-372
Adjustable 3 Point Strut Tower Brace- 305 motor	CF-373
Strut Tower Upgrade Kit	CF-387
Strut Tower Upgrade Kit-305 motor	CF-388
Non Adjustable 2 Point Strut Tower Brace, Throttle Body Motors	CF-425
Non Adjustable 3 Point Strut Tower Brace, Throttle Body Motors	CF-426
Non Adjustable 2 Point Strut Tower Brace, TPI Motors	CF-427
Non Adjustable 3 Point Strut Tower Brace, TPI Motors	CF-428

## Tubular K-Members

Heidts tubular K-Members reduce weight and are the perfect fit for an LS swap or stock engines. Our K-Members come with 3 degrees of built in anti-dive for better handling on the street or track

Description	Part#
Tubular K-Member For Use With Coil Over Shocks	CF-401
Tubular K-Member For Use With Stock Shocks	CF-402
Front Tubular Lower Control Arms	CA-370
Front Swaybar Kit, 1-3/8" Solid	SB-250



Silver Streak  
Builder: Hawks Motorsports



AL-102411



AL-401010



RC-551



RC-588



AL-101061



RC-561



CF-373



CF-401

# '93-02 CAMARO/FIREBIRD



## FRONT SUSPENSION BOLT ON COMPONENTS

Description	Part#
STAGE I KIT - Coilover Shocks + Swaybar	9302-11
STAGE II KIT - Coilover Shocks + Swaybar + A-arms (CF-490, CF-511)	9302-12
STAGE III KIT - Includes Stage II + K-member (CF-450)	9302-13
Front Coilover Kit, Single Adjustable (300, 325, 350, 400)	CO-109-XXX
Front Swaybar, 1-3/8" Solid	SB-254
Splined Front Swaybar	SB-425
Adjustable Upper Control Arms	CF-490
Upper A-arm Bracket Kit, OE Replacement	CF-520
Upper A-arm Bracket Kit, Coilover	CF-525
Boxed Lower Control Arms, Non-Adjustable	CF-511
Boxed Lower Control Arms, Adjustable	CF-512
Front K-member	CF-450
Front Chromoly K-member	CF-450-C
2 Point Strut Tower Brace	AL-401059
3 Point Strut Tower Brace	AL-401060
Chevy Motor Stands PRO-G - SB ONLY	MM-220
LS Block Adapters (Urethane Mounts w/Adapters)(Short & Wide)	MM-200



## REAR SUSPENSION BOLT ON COMPONENTS

Description	Part#
STAGE I KIT - Coilover Shocks + Swaybar + NA Control Arms + Panhard	9302-51
STAGE II KIT - Includes Everything In Stage 1+ Subframe Connector	9302-52
STAGE III KIT - Includes Everything in Stage 1 and 2 + Torque Arm	9302-53
Outer Subframe Connectors	AL-102410
Rear Coilover Shock Conversion Kit (125#,150#,175#,200#)	CO-107-XXX
Rear Swaybar- Solid Axle	SB-251
Non-Adjustable Lower Control Arms	AL-401010
Adjustable Lower Control Arms	RC-551
Lower Control Arm & Panhard Kit (RC-551, RC-556, RC-561, RC-567)	RC-550
Non-Adjustable Panhard Bar	AL-401061
Adjustable Panhard Bar	RC-561
Panhard Bar Relocation Brackets and Mount	RC-567
Adjustable Torque Arm Kit, Tunnel Mount	RC-621







# '64-'72 CHEVELLE & GM A-BODY PRE '73

## GM A-BODY CONTROL ARMS

Replace your tired control arms with **HEIDTS®** tubular upper and lower control arms for the '64-'72 Chevelle, GTO and all other GM A-body cars. Uppers are 1-1/4" dia. tube, and the lowers are a full 1-1/2" tube and all come powder coated and are supplied with ball joints and bushings installed. High performance urethane bushings are standard to tighten up the suspension and allow no deflection under cornering loads for solid, positive handling. Upper arms include offset cross shafts for ease of alignment and allow you to experiment with caster settings, allowing better straight line tracking as well as in the corners. All arms are completely assembled.

AL-501012-U



AL-501012-L



### HIGH PERFORMANCE TALL 2" DROPPED STEEL SPINDLE

It is called a TALL Spindle because the upper ball joint is raised 1-1/2". Different from the factory design, it yields a better camber change during suspension movement. Pivot points are determined by the ball joints on the spindles and bushing locations on the frame, not the control arms. These spindles are STEEL, the strongest ones in the industry.

Description	Part
2" Dropped Spindles, Pair*	SP-110

\*Must use HEIDTS® Control Arms



SP-110



CB-130

### SWAYBARS

Description	Part
64-72 1 1/8" Chevelle Front Swaybar	SB-071
64-72 1" Chevelle Rear Swaybar**	SB-150

\*\*Must Use HEIDTS® 4-Link Package



RC-250

Description	Part#
64-72 Chevelle/GM A-Body Upper Control	AL-501012-U
64-72 Chevelle/GM A-Body Lower Control Arms	AL-501012-L

\*\*We Recommend Using Our Pro-G® Dropped Spindles (SP-110) With Our Control Arms Control Arms can be shipped unassembled for powdercoat painting.

### WILWOOD™ DISC BRAKES

Description	Part#
11" Wilwood Smooth Rotors & 4 Piston Black Calipers	DFE-221-B
11" Wilwood Drilled Rotors & 4 Piston Red Calipers	DFE-221-D-RED
11" Wilwood Drilled Rotors & 4 Piston Polished Calipers	DFE-221-D-P
12" Wilwood Drilled Rotors & 4 Piston Black Calipers	DFE-222-D-B
12" Wilwood Drilled Rotors & 4 Piston Red Calipers	DFE-222-D-RED
12" Wilwood Drilled Rotors & 4 Piston Polished Calipers	DFE-222-D-P
13" Wilwood Drilled Rotors & 6 Piston Black Calipers	DFE-223-D-B
13" Wilwood Drilled Rotors & 6 Piston Red Calipers	DFE-223-D-RED
13" Wilwood Drilled Rotors & 6 Piston Polished Calipers	DFE-223-D-P

For 67-69 Camaro/Firebird & 68-72 Nova only!

### CHEVELLE & GM A-BODY COIL OVER SHOCKS

Coil-Over Shocks make the suspension more tunable, and **HEIDTS®** has them. Billet shock bodies with powder coated springs in different spring rates are the ticket. These shocks are fully adjustable with just the turn of a knob in both compression and rebound for full performance tuning. Ride height is also tunable with adjustment rings. Springs included.

Description	Part#
64-72 Chevelle & GM A-Body Single Adj. Coil-Over Shocks	CB-130
64-72 Chevelle & GM A-Body Double Adj. Coil-Over Shocks	CB-130-D
64-72 Chevelle & GM A-Body (450,550,650#) 11" Powder Coat Springs	CQ-XXX-11
Thrust Bearings For Coil-Over Shocks	CQ-010
Spanner Wrench	TA-001

### REAR 4-LINK PACKAGES

At **HEIDTS®** the answer to handling is their upper and lower rear Suspension Links for the '64-'72 Chevelle, GTO and all other GM A-body cars. These links are state of the art in both design and fabrication. Upper Links are adjustable, 1-1/4" dia. tube, and the lowers area full 1-1/2" x 2" square tube. They come powder coated black and are supplied with greaseable swivel and fixed bushings installed. High performance urethane bushings are used to tighten up the suspension and swivel ends allow roll deflection under cornering loads for absolutely solid, positive handling. All rear links are completely assembled, ready to install and include new hardware.

Description	Part#
64-66 Chevelle / 64-66 GM A-Body Rear 4-Link	RC-240
67-72 Chevelle / 67-72 GM A-Body Rear 4-Link	RC-250

### CHASSIS BRACE LINKS

Chassis Brace Links attach to the upper bolt of the Rear 4-Links and to the chassis crossmember. They take the added stress from the new Rear 4-Links. Sold in pairs.

Description	Part#
64-66 Chevelle/GM A-Body Rear Axle Link Braces	RC-255
67-72 Chevelle/GM A-Body Rear Axle Link Braces	RC-251



**UPPER AND LOWER CONTROL ARMS**

Description	Part#
67-69 Camaro/Firebird Control Arm Kit	AL-501010
70-81 Camaro Upper Control Arm Kit	AL-501011
68-72 Nova Control Arm Kit	AL-501010
68-72 GM A Body Control Arm Kit	AL-201012
78-83 GM G-Body Control Arm Kit	AL-501013
70-81 Camaro Tubular Upper Control Arms	CA-302
70-81 Camaro Tubular Lower Control Arms	CA-312
70-81 Camaro Tubular Lower Control Arms, Coilover	CA-312-M

(AL- PART NUMBERS FOR USE WITH STOCK SPINDLES AND COIL OVERS ONLY)

**WILWOOD™ DISC BRAKES**

Description	Part#
11" Wilwood Smooth Rotors & 4 Piston Black Calipers	DFE-221-B
11" Wilwood Drilled Rotors & 4 Piston Red Calipers	DFE-221-D-RED
11" Wilwood Drilled Rotors & 4 Piston Polished Calipers	DFE-221-D-P
12" Wilwood Drilled Rotors & 4 Piston Black Calipers	DFE-222-D-B
12" Wilwood Drilled Rotors & 4 Piston Red Calipers	DFE-222-D-RED
12" Wilwood Drilled Rotors & 4 Piston Polished Calipers	DFE-222-D-P
13" Wilwood Drilled Rotors & 6 Piston Black Calipers	DFE-223-D-B
13" Wilwood Drilled Rotors & 6 Piston Red Calipers	DFE-223-D-RED
13" Wilwood Drilled Rotors & 6 Piston Polished Calipers	DFE-223-D-P

For 67-69 Camaro/Firebird & 68-74 Nova only!



DFE-221-B

DFE-222-D-B

**COIL OVER SHOCKS**

Description	Part#
67-69 Camaro/Firebird/68-74 Nova Single Adj. Coil-Over Shocks	CB-130
67-69 Camaro/Firebird/68-74 Nova Double Adj. Coil-Over Shocks	CB-130-D
70-81 Camaro/Firebird Single Adj. Coil-Over Shocks	CB-120
70-81 Camaro/Firebird Double Adj. Coil-Over Shocks	CB-120-D
67-69 Camaro 450# SBC	CQ-450-11
70-81 Camaro 450# SBC	CQ-450-10-F
70-81 Camaro/Firebird 550# 10" Silver Powder Coat Springs - Big Block	CQ-550-10-F
Thrust Bearings For Coil-Over Shocks	CQ-010
Spanner Wrench	TA-001

Available for Small and Big Block



CB-130

**HIGH PERFORMANCE TALL 2" DROPPED STEEL SPINDLE**

It is called a TALL Spindle because the upper ball joint is raised 1-1/2". Different from the factory design, it yields a better camber change during suspension movement. Pivot points are determined by the ball joints on the spindles and bushing locations on the frame, not the control arms. These spindles are STEEL, the strongest ones in the industry.



Description	Part#
2" Dropped Spindles, Pair	SP-110

For 67-69 Camaro/Firebird & 68-74 Nova only!

**SWAYBARS**

Description	Part#
67-69 Camaro/Firebird/68-72 Nova 1-1/8" Diameter Swaybar	SB-069
70-81 Camaro/Firebird 1-5/16" Diameter Swaybar	SB-070

For 67-69 Camaro/Firebird & 68-74 Nova only!



SP-110

SB-069



# '64½ - '70 MUSTANG, '67-'70 COUGAR '60-'65 FALCON, '64-'65 COMET **MUSTANG II IFS**

Owner & Builder:  
Stang-Aholics



**All New Design! Heidts new Mustang II crossmember allows for better fitment and easier installation of the Ford 289, 302, 351, 390, 460, Mod and Coyote motors.**



**Now Available!  
Double Adjustable  
Shocks**

Shown with options.  
Product is painted for catalog purposes only!

## **COMPLETE BASE KIT**

### **COMPLETE BASE KIT**

Description	Part#
64 1/2 -70 Mustang/67-70 Cougar (351w, 351c, 460, FE Motors)	PM-320-E-K
64 1/2 -70 Mustang/67-70 Cougar (289, 302, Coyote, Mod Motors)	PX-320-E-K
60-65 Falcon /64-65 Comet	PX-330-E-K

### **CONTROL ARM OPTIONS**

Description	Part#	
Tubular Control Arms	CA-116	Included
Coil Over Tubular Arms	CA-116-M	Upgrade

### **BRAKE OPTIONS**

Description	Part#	
11" Iron Rotors & GM Calipers	DF-201-B-G or F-G	Included
12" Wilwood Drilled Rotors & 4 Piston Polished Calipers	DFM-208-P	Upgrade
13" Wilwood Drilled Rotors & 6 Piston Polished Calipers	DFM-206-P	Upgrade

Additional options available. Call for pricing.

### **SPINDLE OPTIONS**

Description	Part#	
2" Dropped Spindles	SP-101-K	Included

### **RACK & PINION OPTIONS**

Description	Part#	
Manual Rack & Pinion	MP-018-K	Included
Power Rack & Pinion	MP-038-3-K	Upgrade
Power Rack W/ Stainless Steel Tie Rod Ends	MP-038-SS-K	Upgrade

### **SHOCK & SPRING OPTIONS**

Description	Part#	
Stock Springs & Shocks 300# - 375#	MP-007-XXX-K	Included
Single Adj. Billet Coil-Over Shocks & Springs 375# - 700#	MP-050-XXX-K	Upgrade
Double Adj. Billet Coil-Over Shocks & Springs	MP-050-XXX-D	Upgrade
Thrust Bearings For Coil-Over Shocks	CQ-010	Upgrade
Spanner Wrench	TA-001	Upgrade

### **OPTIONS**

	Part#
Stabilizer Bar Kit- 1" Solid/ 64-70 Mustang MII V1 or V2	SB-429
64-66 Mustang Inner Panels	PX-325
67-70 Mustang Inner Panels	PX-326
Kit, Coyote, 4.6L MOD, Motor Mounts and Stands	MM-281
Kit, 351W SB Motor Mounts and Stands	MM-263
Kit, 351C Motor Mounts and Stands	MM-287
Kit, FE 390, 427, 428 BB Motor Mounts and Stands	MM-264
Kit, FE 429, 460 BB Motor Mounts and Stands	MM-288

**HEIDTS®** suspension systems will give your Mustang, Cougar or Falcon the ride, handling and stopping power you are after (Comes standard with dropped spindles). Assembled package is shown so you can see what your completed front end will look like.

### **INCLUDED IN BASE KIT:**

- **HEIDTS®** Crossmember • 2" Dropped Spindles • Tubular Upper & Lower Arms • 11" Rotors with Single Piston Calipers
- Manual Rack & Pinion Steering • Stock Shocks & Springs

\* Air bags will not fit.

\* **Note:** These kits all require the use of a Rear Sump Style Oil Pan



MP-038-3-K



DF-201



DFM-208



DFM-206



SP-101-K



**`64½ - `70 MUSTANG, `67-`70 COUGAR  
`60-`65 FALCON, `64-`65 COMET**



# MUSTANG II IFS

Now you can give your Mustang superior handling. HEIDTS® now offers Mustang II Front Suspension crossmembers and components to make it easy!

## ADDITIONAL OPTIONS

Description	Part#
Polished Stainless Steel Balljoint Caps, Pair	MP-034
64-66 Mustang Inner Panels	PX-325
67-70 Mustang Inner Panels	PX-326
64-66 Mustang 36 Spline Power Rack Steering Kit For Stock Column DD Shaft	SC-290-DD
64-66 Mustang Manual Rack Steering Kit For Stock Column DD Shaft	SC-291-DD
67-68 Mustang Power Rack Steering Kit for Stock Column DD Shaft	SC-295-DD
67-68 Mustang Manual Rack Steering Kit For Stock Column DD Shaft	SC-296-DD
67-70 Mustang Brake Pedal Kit for Automatic Trans	DP-001
67-70 Mustang Brake Pedal Kit for Manual Trans	DP-002
60-65 Falcon Inner Fender Panels	PX-328



MP-050



PX-325



DP-001

DP-002



MP-035



MM-130



MM-135



SB-429



**Order/Tech: 800-841-8188**

# '64 1/2 - '70 MUSTANG FOR HEIDTS SUPERIDE® II



Now Available!  
Double Adjustable  
Shocks



**ALL NEW DESIGN!  
NOW FITS THE COYOTE & FE MOTORS!**

Product is painted for catalog purposes only! All kits ship with Silver Powder Coated Springs - not shown.

## COMPLETE BASE KIT

### INCLUDED IN BASE KIT:

- HEIDTS® Crossmember and Boxing Plates • 2" Dropped Spindles • Tubular Upper & Lower Arms • Manual Rack & Pinion Steering • 11" Rotors with 4 Piston Wilwood Calipers • Billet Single Adjustable Coil-Over Shocks with Silver Powder Coated Springs



BX-350



BS-040-SS

BS-002-XX



DF-202

DF-208-P

DF-206-B



MP-038-3-K

## COMPLETE BASE KIT

Description	Part#
64 1/2 - 70 Mustang (289, 302, Mod, Coyote Motors)	BX-350
64 1/2 - 70 Mustang (351w, 351c, FE, 460 Motors)	BX-360

## CONTROL ARM OPTIONS

Description	Part#	
Tubular Arms	BS-040	Included
Stainless Steel Tubular Arms	BS-040-SS	Upgrade

## BRAKE OPTIONS

Description	Part#	
11" Iron Rotors & 4 Piston Black or Polished Calipers	DF-202	Included
12" Wilwood Drilled Rotors & 4 Piston Black, Polished Calipers	DFS-208-P or B	Upgrade
13" Wilwood Drilled Rotors & 6 Piston Black, Polished Calipers	DFS-206-B	Upgrade

Additional options available. Call for pricing.

## RACK & PINION OPTIONS

Description	Part#	
Manual Rack & Pinion	MP-018-1-K	Included
Power Rack & Pinion	MP-038-3-K	Upgrade
Power Rack W/ Stainless Steel Tie Rod Ends	MP-038-SS-K	Upgrade

## SPINDLE OPTIONS

Description	Part#	
2" Dropped Spindles	SP-101-K	Included

## SHOCK & SPRING OPTIONS

Description	Part#	
Single Adj. Billet Coil-Over Shocks 400#, 450#, 500#, 550# Springs	BS-001-XX	Included
Double Adj. Billet Coil-Over Shocks 400#, 450#, 500#, 550# Springs	BS-001-D-XX	Upgrade
400#, 450#, 500#, 550# Springs/Polished Billet Coil-Over Shocks	BS-002-XX	Upgrade
Thrust Bearings For Coil-Over Shocks	CQ-010	Upgrade
Spanner Wrench	TA-001	Upgrade

## ADDITIONAL OPTIONS

Description	Part#	
Plain Swaybar	SB-429	Upgrade
64-66, 67-70 Mustang Inner Panels	PX-325	Upgrade
67-70 Mustang Inner Panels	PX-326	Upgrade
64-66 Mustang 36 Spline Power Rack Steering Kit For Stock Column	SC-290-DD	Upgrade
64-66 Mustang Manual Rack Steering Kit For Stock Column DD Shaft	SC-291-DD	Upgrade
67-68 Mustang 36 Spline Power Rack Steering Kit For Stock Column	SC-295-DD	Upgrade
67-68 Mustang Manual Rack Steering Kit For Stock Column DD Shaft	SC-296-DD	Upgrade
Kit, 351W SB Motor Mounts and Stands (MM-257 & MM-259)	MM-263	Upgrade
Kit, 351C Motor Mounts and Stands (MM-285 & MM-259)	MM-287	Upgrade
Kit, FE 390, 427, 428 BB Motor Mounts & Stands	MM-264	Upgrade
Kit, FE 429, 460 BB Motor Mounts and Stands	MM-288	Upgrade



# '64 1/2- '70 MUSTANG, '60-'65 FALCON

## Bolt-In Rear HEIDTS PRO-G® 4-Link Kit



Bolt on maximum performance for your Mustang or Falcon. Kit includes chassis and axle brackets, adjustable links, full upper coil-over crossmember, panhard bar, adjustable HEIDTS® coil-overs and all hardware. Completely bolt-on, with no cutting or floor modifications. Adjustable 4-link mounts allow suspension tuning. Axle housing with brackets installed also available.

### COMPLETE BASE KIT

**COMPLETE 4-LINK BASE KIT** \* Note: Will not fit Falcon convertible, Ranchero or Cougar.

Description	Part#
64 1/2 - 70 Mustang	RM-101
64 1/2 - 70 Mustang	RM-101-PG
60 - 65 Falcon	RF-101
67-70 Cougar	RG-101-PG

### LINKS & HARDWARE

Description	Part#	
64 1/2 - 70 Mustang Plain Links and Panhard Bar	RM-104	Included
60 - 65 Falcon Plain Links and Panhard Bar	RF-104	Included
64 1/2 - 70 Mustang Polished Stainless Steel Links and Panhard Bar	RM-106	Upgrade
60 - 65 Falcon Polished Stainless Steel Links and Panhard Bar	RF-106	Upgrade

### SHOCK & SPRING OPTIONS

Description	Part#	
Black Coil-Over Shocks	CO-101	Included
250#, 300#, 350# Black Coil Springs	CR-XXX-11-B	Included
Single Adjustable Billet Coil-Over Shocks	CB-105	Upgrade
Double Adjustable Billet Coil-Over Shocks	CB-105-D	Upgrade
250#, 300#, 350# Silver Powder Coated Coil Springs	CSV-XXX-11-C	Included
Thrust Bearings For Coil-Over Shocks	CQ-010	Upgrade
Spanner Wrench	TA-001	Upgrade

### REAR AXLE HOUSING WITH BRACKETS

Description	Part#	
64 1/2 - 66 Mustang/60-65 Falcon Housing - 58" Track Width	RM-040-58-H	Upgrade
67-70 Mustang Stock/Race - 59" Track Width	RM-040-59-H	Upgrade

### HEAVY DUTY AXLE OPTIONS

Description	Part#	
64-66 Mustang/60-65 Falcon 31 Spline Axles, 58" Track Width	RM-041-31	Upgrade
67-70 Mustang Stock/Race - 59" Track Width	RM-043-31	Upgrade

### 3RD MEMBER OPTIONS

Description	Part#	
Open 31 Spline 3.00, 3.25, 3.50, 3.70, 3.90, 4.11 Ratio	BN-XXX-I	Upgrade
Positraction 31 Spline 3.00, 3.25, 3.50, 3.70, 3.90, 4.11 Ratio	BN-XXX-I-L	Upgrade

### BRAKE OPTIONS

Description	Part#	
11" Heavy Duty Drum Brake	RN-054	Upgrade
12" Iron Rotors, GM Single Piston Calipers W/Parking Brake	DR-005-E-P	Upgrade
12" Wilwood Smooth Rotors & 4 Piston Black Calipers W/Parking Brake	DRE-005-P-B	Upgrade
12" Wilwood Smooth Rotors & 4 Piston Red Calipers W/Parking Brake	DRE-005-P-RED	Upgrade
12" Wilwood Smooth Rotors & 4 Piston Polished Calipers W/Parking Brake	DRE-005-P	Upgrade
12" Wilwood Drilled Rotors & 4 Piston Black Calipers W/Parking Brake	DRE-005-P-D-B	Upgrade
12" Wilwood Drilled Rotors & 4 Piston Red Calipers W/Parking Brake	DRE-005-P-D-RED	Upgrade
12" Wilwood Drilled Rotors & 4 Piston Polished Calipers W/Parking Brake	DRE-005-P-D	Upgrade

### STIFFENER & CONNECTOR OPTIONS

Description	Part#	
Rear Sway Bar	SB-016	Upgrade
Chassis Stiffener - Coupe or Fastback	RM-023	Upgrade
Subframe Connectors - Mustang Coupe or Fastback, Cougar	RM-102	Upgrade
Subframe Connectors - Mustang Convertible, Cougar	RM-103	Upgrade
Subframe Connectors - Falcon - Coupe Only	RF-102	Upgrade



Product is painted for catalog purposes only! All kits ship with Silver Powder Coated Springs - not shown.

### INCLUDED IN BASE KIT:

- 4-Links and Axle Brackets
- Top Crossmember
- Panhard Bar
- Standard Coil-Over Shocks, Black Body and Black Springs



RM-101-PG

Now Available!  
Double Adjustable  
Shocks



CO-101  
CR-XXX-11-B



BN-XXX-I



RN-054



DR-005-P



RM-102



RM-023

HEIDTS® MUSCLE CAR PARTS



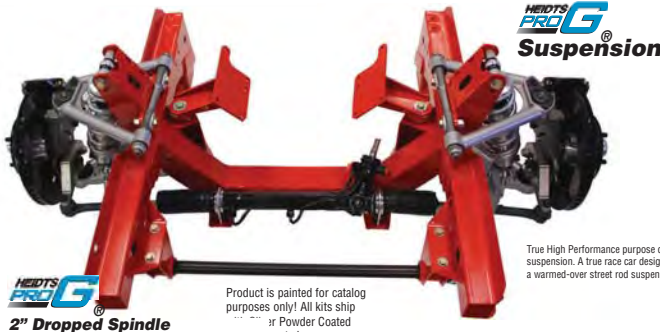




# 64 1/2 - 70 MUSTANG - TRACK WIDTH 58"

## HEIDTS PRO-G FULL FRONT SUSPENSION

All New Design! Heidts new PRO-G IFS allows for better fitment and easier installation of all Ford Motors including the Coyote.



HEIDTS PRO-G Suspension

HEIDTS® now offers their HEIDTS Pro-G® full suspension package for early Mustangs. This Pro-Touring front end will give your car unbelievable cornering and handling. This kit includes everything you need to transform your Mustang. Kit includes: fully adjustable tubular control arms, Wilwood disc brakes, power rack & pinion, and motor mounts that will accept any of the popular Ford engines.

True High Performance purpose designed suspension. A true race car designed geometry, not a warmed-over street rod suspension.

HEIDTS PRO-G  
2" Dropped Spindle

Product is painted for catalog purposes only! All kits ship in powder coat or Powder Coated not shown.

Now Available!  
Double Adjustable  
Shocks

### COMPLETE BASE KIT

#### COMPLETE BASE KIT

Description	Part#
64 1/2 - 70 Mustang	MTF-201
67 - 70 Cougar	MTF-101

#### CONTROL ARM OPTIONS

Description	Part#	Included
Plain Control Arms	CA-480	Included

#### SPINDLE OPTIONS

Description	Part#	Included
2" Dropped Spindles	SP-110	Included

#### BRAKE OPTIONS

Description	Part#	Included
11" Wilwood Rotors & 4 Piston Black Calipers	DFP-221-B	Included
12" Wilwood Drilled Rotors & 4 Piston Black Calipers	DFP-222-D-B	Upgrade
13" Wilwood Drilled Rotors & 6 Piston Black, Polished Calipers	DFP-223-D-B	Upgrade

Additional options available. Call for pricing.

#### RACK & PINION OPTIONS

Description	Part#	Included
Power Rack with 17mm "DD" Input Shaft	OPR-1-D-K	Included

#### SHOCK & SPRING OPTIONS

Description	Part#	Included
Steel Coilover Shock- Black	CO-102	Included
Single Adjustable Coilover- Billet	CB-105-G	Upgrade
Double Adjustable Coilover-Billet	CB-105-D-G	Upgrade
400#, 450#, 500#, 550# Silver Powder Coated Springs	CSV-XXX-10	Included
Thrust Bearings For Coil-Over Shocks	CQ-010	Upgrade
Spanner Wrench	TA-001	Upgrade

#### ADDITIONAL OPTIONS

Description	Part#	Included
64-66 Mustang Inner Fender Panels	PX-325	Upgrade
67-70 Mustang Steel Inner Fender Panels	PX-326	Upgrade
Swaybar 1 1/4 Splined	SB-403	Upgrade
1" Swaybar	SB-112-K	Upgrade
Upper Arm "Heim Style" Adjuster Kit	CF-104	Upgrade
POWER STEERING RELOCATION BRACKET KIT, 5.0 COYOTE	PS-180	Upgrade



DF-222-D-P

DF-223-D-B

SP-110



CB-160

SP-110

PX-325

# '64 1/2 - '70 MUSTANG



Owner & Builder:  
Stang-Aholics

## HEIDTS PRO-G IRS

Now Available!  
Double Adjustable  
Shocks

### HIGH HORSEPOWER INDEPENDENT REAR SUSPENSION

#### WHY HEIDTS PRO-G<sup>®</sup> IRS



Do you really want to go fast and out-handle everyone else on the autocross or road race course in your Mustang? Full independent rear suspension is the only way to go. HEIDTS<sup>®</sup> now has a High Horsepower Independent Rear Suspension bolt-In Package that will do the job just fine.

*It is a true high horsepower package, with upper links and heavy duty CV joints. The upper link produces -.5° of camber curve at 3/4 of total travel during very high cornering loads. Forward struts, attached to the sub-frame connectors insures the wheels stay in place during hard acceleration.*

**COMPLETE BASE KIT** (500HP and 800HP Options Available)



Available with cast aluminum center section or steel fabricated housing.

Product is painted for catalog purposes only! All kits ship with Silver Powder Coated Springs - not shown.

Description	Part#
64 1/2 - 70 Mustang High Horsepower IRS - Plain Rotors	IRM-101
64 1/2 - 70 Mustang High Horsepower IRS - Drilled & Slotted Rotors	IRM-101-S
64 1/2-70 Mustang Standard Horsepower IRS- Plain Rotor	IRM-101
64 1/2-70 Mustang Standard Horsepower IRS- Drilled Rotor	IRM-101-S

#### SHOCK & SPRING OPTIONS

Description	Part#	
Single Adjustable Billet Coil-Over Shocks	CB-106	Included
Double Adjustable Billet Coil-Over Shocks	CB-106-D	Upgrade
350# Silver Powder Coated Springs	CSV-350-09	Included
400# Silver Powder Coated Springs	CSV-400-09	Included
450# Silver Powder Coated Springs	CSV-450-09	Included
550# Silver Powder Coated Springs	CSV-450-09	Included

#### 3RD MEMBER OPTIONS

Description	Part#	
Positraction 31 Spline 3.00 Ratio	BN-300-I-L	Included
Positraction 31 Spline 3.25 Ratio	BN-325-I-L	Included
Positraction 31 Spline 3.50 Ratio	BN-350-I-L	Included
Positraction 31 Spline 3.70 Ratio	BN-370-I-L	Included
Positraction 31 Spline 3.90 Ratio	BN-390-I-L	Included
Positraction 31 Spline 4.11 Ratio	BN-411-I-L	Included

#### SUBFRAME CONNECTOR

Description	Part#	
64 1/2 - 70 Mustang Subframe Connectors - Coupe	RM-102-IRM	Included
64 1/2 - 70 Mustang Subframe Connectors - Convertible	RM-103-IRM	Included

#### HOUSING OPTIONS

Description	Part#	
Polished Aluminum 9" Housing	BM-001-P	Upgrade
Steel Fab 9" Housing	BT-410	Upgrade

#### COMPLETE BASE KIT



\*Subframe Connectors Included.



#### WHAT YOU GET:

- Track Width 56 1/2"
- 9" Aluminum HSG.
- 3rd Member, Iron, Posi
- CV Joint Halfshafts
- Tubular Upper & Lower Arms
- Steel Outer Uprights
- Top Crossmember
- Frame Mounting Brackets
- Front Pinion Support
- Forward Struts\*
- 10.5" Wilwood Rotors
- Black Wilwood Calipers
- Billet Single Adjustable Coil-Overs with Silver Powder Coated Springs
- Posi-Traction

#### OPTIONS: CALL FOR DETAILS.

- Choice of Gear Ratios
- Parking Brake Kit and Cable Kit

#### PARKING BRAKE OPTIONS

Description	Part#
Parking Brake Kit & Cable Kit- Black	PB-101
E-Stop Actuator	BM-013
Parking Brake Kit- Silver	PB-101-S



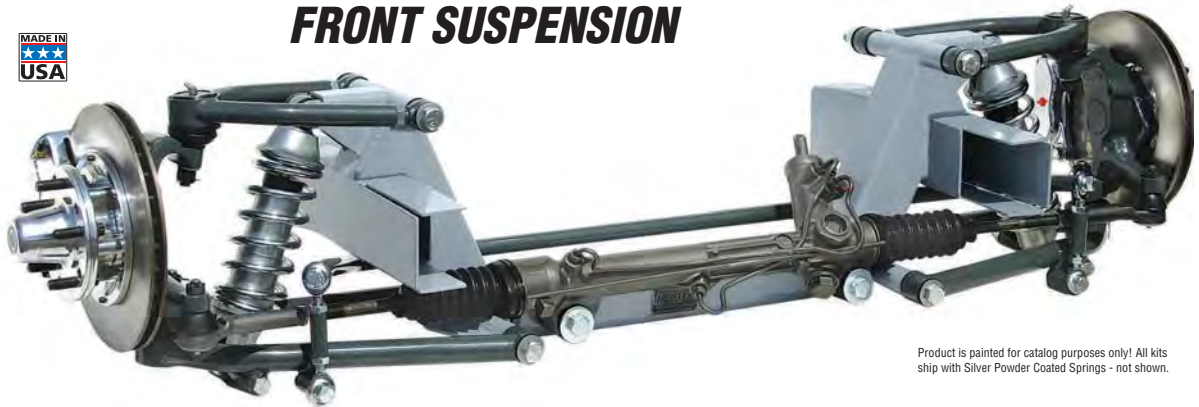
Order/Tech: 800-841-8188

HEIDTS<sup>®</sup> MUSCLE CAR PARTS

# HEIDTS SUPERIDE® II IFS

\*LOWERS VEHICLE 2"

## '66 - '67 FAIRLANE/COMET HEIDTS SUPERIDE® II FRONT SUSPENSION



Product is painted for catalog purposes only! All kits ship with Silver Powder Coated Springs - not shown.

### INCLUDED IN BASE KIT:

- HEIDTS® Crossmember and Boxing Plates • Spindles
- Tubular Upper & Lower Arms • Power Rack & Pinion Steering • 11" Rotors with 4 Piston Wilwood Calipers
- Billet Single Adjustable Coil-Over Shocks with Silver Powder Coated Springs

Now Available!  
Double Adjustable  
Shocks



### COMPLETE BASE KIT

Description	Part#
66-67 Fairlane / 66-67 Comet	BX-601

### BRAKE OPTIONS

Description	Part#
11" Iron Rotors & 4 Piston Black or Polished Calipers	DFS-202-C-B or C-P Included
12" Wilwood Drilled Rotors & 4 Piston Black, Polished Calipers	DFS-208-P Upgrade
13" Wilwood Drilled Rotors & 6 Piston Black Calipers	DFS-206-B Upgrade

Additional options available. Call for pricing.

### CONTROL ARM OPTIONS

Description	Part#
Tubular Arms (Narrowed available)	BS-021-RS Included
Stainless Steel Tubular Arms (Narrowed available)	BS-022-RS Upgrade

### SPINDLE OPTIONS

Description	Part#
Stock Spindles Recommended	MP-028 Included
2" Dropped Spindles	SP-101-K Included

### POWER RACK & PINION OPTIONS

Description	Part#
Power Rack	MP-038-3-K-CT Included
Chrome Power Rack	MP-038-C-K-CT Upgrade

### SHOCK & SPRING OPTIONS

Description	Part#
Single Adjustable Billet Coil-Over Shocks 400#, 450#, 500#, 550#	BS-001-XX Included
Double Adjustable Billet Coil-Over Shocks 400#, 450#, 500#, 550#	BS-001-D-XX Upgrade
Thrust Bearings For Coil-Over Shocks	CQ-010 Upgrade
Spanner Wrench	TA-001 Upgrade

### ADDITIONAL OPTIONS

Description	Part#
Plain Sway Bar	SB-190 Upgrade
Small Block Ford Motor Mounts	MM-140 Upgrade
Steel Inner Fender Panels	PX-327 Upgrade



DF-202

DF-208

DF-206-B-K



MP-038-3-K-CT



BS-022-RS

BS-002

TA-001



PX-327



# '66 - '67 FAIRLANE 66 - '67 COMET

LOWERS VEHICLE 2"

## Bolt-In Rear 4-Link Kit

**HEIDTS PRO-G®** Rear 4-Link offers maximum performance for your Fairlane. Completely bolt-on, with no cutting or floor modifications. Adjustable 4-link mounts allow suspension tuning. Axle housing with brackets installed also available.

### INCLUDED IN BASE KIT:

- Adjustable Links with Frame and Axle Brackets
- Full Upper Coil-Over Crossmember • Standard Coil-Over Shocks, Black Body and Black Springs



Now Available!  
Double Adjustable  
Shocks

Product is painted for catalog purposes only! All kits ship with Silver Powder Coated Springs - not shown.

### COMPLETE BASE KIT

Description	Part#
66-67 Fairlane/Comet	RF-110

### LINKS & HARDWARE

Description	Part#	
66-67 Fairlane/Comet Plain Links	RF-111	Included
66-67 Fairlane/Comet Polished Stainless Steel Links	RF-112	Upgrade

### SHOCK & SPRING OPTIONS

Description	Part#	
Black Coil-Over Shocks	CO-101	Included
250#, 300#, 350# Black Coil Springs	CR-XXX-11-B	Included
Single Adjustable Billet Coil-Over Shocks	CB-105	Upgrade
Double Adjustable Billet Coil-Over Shocks	CB-105-D	Upgrade
250#, 300#, 350# Silver Powder Coated Coil Springs	CSV-XXX-10	Included
Thrust Bearings For Coil-Over Shocks	CQ-010	Upgrade
Spanner Wrench	TA-001	Upgrade

### REAR AXLE HOUSING

Description	Part#	
66-67 Fairlane/Comet Rear 9" Housing with Brackets	RF-115	Upgrade

### HEAVY DUTY AXLE

Description	Part#	
31 Spline Axle -Ford Bolt Pattern - 60" Track Width	RM-042-31	Upgrade

### 3RD MEMBER OPTIONS

Description	Part#	
Open 31 Spline 3.00, 3.25, 3.50, 3.70, 3.90, 4.11 Ratio	BN-XXX-I	Upgrade
Positraction 31 Spline 3.00, 3.25, 3.50, 3.70, 3.90, 4.11 Ratio	BN-XXX-L	Upgrade

### BRAKE OPTIONS

Description	Part#	
11" Heavy Duty Drum Brake	RN-054	Upgrade
12" Iron Rotors, GM Single Piston Calipers W/Parking Brake	DR-005-E-P	Upgrade
12" Wilwood Smooth Rotors & 4 Piston Black Calipers W/Parking Brake	DRE-005-P-B	Upgrade
12" Wilwood Smooth Rotors & 4 Piston Red Calipers W/Parking Brake	DRE-005-P-RED	Upgrade
12" Wilwood Smooth Rotors & 4 Piston Polished Calipers W/Parking Brake	DRE-005-P	Upgrade
12" Wilwood Drilled Rotors & 4 Piston Black Calipers W/Parking Brake	DRE-005-P-D-B	Upgrade
12" Wilwood Drilled Rotors & 4 Piston Red Calipers W/Parking Brake	DRE-005-P-D-RED	Upgrade
12" Wilwood Drilled Rotors & 4 Piston Polished Calipers W/Parking Brake	DRE-005-P-D	Upgrade

### OPTIONS

Description	Part#	
Swaybar	SB-195	Upgrade



HEIDTS® MUSCLE CAR PARTS



Order/Tech: 800-841-8188

# '62-'67 NOVA SUBFRAME

## '62-'67 NOVA SUBFRAME / CROSSMEMBER SUSPENSION PACKAGE AND ASSEMBLY



Now you can give your '62-'67 Chevy Nova the lowered look and superior handling the street rods have enjoyed for years. HEIDTS® now offers their Front Suspension crossmembers and components for '62-'67 Novas to make it easy!

Product is painted for catalog purposes only! All kits ship with Silver Powder Coated Springs - not shown.



\* Air bags will not fit.

CA-112-SS



DF-202



DF-208



DF-206-B-K



MP-038-3-K



MP-050



SP-101-K



CX-325

### INCLUDED IN BASE KIT:

- HEIDTS® Front Subframe • Tubular Upper & Lower Arms • Stock Spindles • 11" Rotors with Single Piston Calipers • Manual Rack & Pinion Steering • Stock Shocks and Springs

Now Available!  
Double Adjustable  
Shocks

### COMPLETE BASE KIT

#### COMPLETE BASE KIT

Description	Part#
62-67 Nova	CX-320-S-K

#### CONTROL ARM OPTIONS

Description	Part#	
Tubular Arms (Narrowed available)	CA-112	Included
Stainless Steel Tubular Arms (Narrowed available)	CA-112-SS	Upgrade

#### SPINDLE OPTIONS

Description	Part#	
Stock Spindles	MP-028	Included
2" Dropped Spindles	SP-101-K	Included

#### BRAKE OPTIONS

Description	Part#	
11" Iron Rotors & GM Metric Calipers	DF-201-B-G or F-G	Included
12" Wilwood Drilled Rotors & 4 Piston Black, Polished Calipers	DFM-208-P	Upgrade
13" Wilwood Drilled Rotors & 6 Piston Black, Black Calipers	DFM-206-B	Upgrade

Additional options available. Call for pricing.

#### RACK & PINION OPTIONS

Description	Part#	
Manual Rack & Pinion	MP-018-1-K	Included
Power Rack & Pinion	MP-038-3-K	Upgrade
Power Rack W/ Stainless Steel Tie Rod Ends	MP-038-SS-K	Upgrade

#### SHOCK & SPRING OPTIONS

Description	Part#	
275# - 375# Springs & Stock Shocks	MP-007-XXX-K	Included
Single Adjustable Billet Coil-Over Shocks 275# - 375# Springs	MP-050-XXX-K	Upgrade
Double Adjustable Billet Coil-Over Shocks 275# - 375# Springs	MP-050-XXX-D	Upgrade
Thrust Bearings For Coil-Over Shocks	CQ-010	Upgrade
Spanner Wrench	TA-001	Upgrade

#### ADDITIONAL OPTIONS

Description	Part#	
62-67 Nova Swaybar	SB-060	Upgrade
Polished Stainless Steel Balljoint Caps, Pair	MP-034	Upgrade
62-65 Nova Steel Inner Fender Panels	CX-325	Upgrade
66-67 Nova Steel Inner Fender Panels	CX-326	Upgrade
67 Nova Stock Column to Power Rack	SC-249-DD	Upgrade
67 Nova Stock Column to Manual Rack	SC-239-DD	Upgrade

# '62-'67 NOVA HEIDTS SUPERIDE® II FOR SUBFRAME



## INCLUDED IN BASE KIT:

- HEIDTS® Front Subframe • Tubular Upper & Lower Arms • Stock Spindles • 11" Rotors with 4 Piston Wilwood Calipers
- Manual Rack & Pinion Steering • Billet Single Adjustable Coil-Over Shocks

Now Available!  
Double Adjustable  
Shocks

## COMPLETE BASE KIT S

### COMPLETE BASE KIT

Description	Part#
62-67 Nova	BX-320

### CONTROL ARM OPTIONS

Description	Part#	
Tubular Arms (Narrowed available)	BS-025	Included
Stainless Steel Tubular Arms (Narrowed available)	BS-026	Upgrade

### BRAKE OPTIONS

Description	Part#	
11" Iron Rotors & 4 Piston Wilwood Black or Polished Calipers	DFS-202-C-B or C-P	Included
12" Wilwood Drilled Rotors & 4 Piston Black, Polished Calipers	DFS-208-P	Upgrade
13" Wilwood Drilled Rotors & 6 Piston Black, Black Calipers	DFS-206-B	Upgrade

Additional options available. Call for pricing.

### SPINDLE OPTIONS

Description	Part#	
Stock Spindles	MP-028	Included
2" Dropped Spindles	SP-101-K	Included

### SHOCK & SPRING OPTIONS

Description	Part#	
Single Adjustable Billet Coil-Over Shocks 400#, 450#, 500#, 550#	BS-001-XX	Included
Double Adjustable Billet Coil-Over Shocks 400#, 450#, 500#, 550#	BS-001-D-XX	Upgrade

### RACK & PINION OPTIONS

Description	Part#	
Manual Rack & Pinion	MP-018-1-K	Included
Power Rack & Pinion	MP-038-3-K	Upgrade
Power Rack W/ Stainless Steel Tie Rod Ends	MP-038-SS-K	Upgrade

### SUPPORT TUBE OPTIONS

Description	Part#	
Support Tubes With Shims	BX-321	Included
Adjustable Support Tubes	BX-322	Upgrade

### ADDITIONAL OPTIONS

Description	Part#	
Plain Swaybar	BS-061	Upgrade
Chrome Swaybar	BS-061-C	Upgrade
62-65 Nova Inner Fender Panels	CX-325	Upgrade
66-67 Nova Steel Inner Fender Panels	CX-326	Upgrade
Polished Stainless Steel Balljoint Caps, Pair	MP-035	Upgrade
Rubber Motor Mounts for Small Block Chevy, Pair	MM-120	Upgrade
67 Nova Stock Column to Power Rack	SC-249-DD	Upgrade
67 Nova Stock Column to Manual Rack	SC-239-DD	Upgrade



\* Air bags will not fit.

Product is painted for catalog purposes only! All kits ship with Silver Powder Coated Springs - not shown.



HEIDTS® MUSCLE CAR PARTS



Order/Tech: 800-841-8188



# '62-'67 NOVA

## TRACK WIDTH 56 3/8"

Owner/Builder:  
Bill Jelinek  
Route 66 Motorsports



# HEIDTS PRO-G® '62-'67 BOLT-ON SUBFRAME

Now Available!  
Double Adjustable  
Shocks



**HEIDTS PRO-G®**  
**2" Dropped Spindle**  
Part of this high performance suspension package. Make your Nova handle like a 600 HP Go-Kart!

**HEIDTS PRO-G®**  
**Suspension**  
True High Performance purpose designed suspension. A true race car designed geometry, not a warmed-over street rod suspension.



Product is painted for catalog purposes only! All kits ship with Silver Powder Coated Springs - not shown.



DF-222-D-P



DF-223-D-B



SP-110



TA-001



CB-160



CX-327

Bolt on the best suspension possible for your '62-'67 Nova. **HEIDTS®** now offers their true bolt on Pro Touring full front subframe. Featuring their new **HEIDTS Pro-G®** Suspension package for unbelievable cornering and overall handling. Simply unbolt and remove your front sheetmetal, engine and trans, your old subframe, then slide in the new complete **HEIDTS®** Subframe. Reinstall your fresh engine, reinstall your sheetmetal and you are set to tear up the streets!

### COMPLETE BASE KIT

#### COMPLETE BASE KIT

Description	Part#
62-67 Nova	NVF-320

#### CONTROL ARM OPTIONS

Description	Part#	
Plain Control Arms	CF-102	Included
Plain Control Arms 8" Addl. Positive Caster (optional)	CF-102-8-H	Included
Polished Stainless Steel Control Arms	CF-103	Upgrade

#### SPINDLE OPTIONS

Description	Part#	
2" Dropped Spindles	SP-110	Included

#### BRAKE OPTIONS

Description	Part#	
11" Wilwood Rotors & 4 Piston Black Calipers	DFP-221-B	Included
12" Wilwood Drilled Rotors & 4 Piston Black, Polished Calipers	DFP-222-D-B	Upgrade
13" Wilwood Drilled Rotors & 6 Piston Black, Polished Calipers		Upgrade

Additional options available. Call for pricing.

#### RACK & PINION OPTIONS

Description	Part#	
Power Rack with 17mm "DD" Input Shaft	OPR-1-D-K	Included

#### SHOCK & SPRING OPTIONS

Description	Part#	
Single Adjustable Billet Coil-Over Shocks	CB-160	Included
Double Adjustable Billet Coil-Over Shocks	CB-160-D	Upgrade
400#, 450#, 500#, 550# Silver Powder Coated Springs	CSV-XXX-10	Included
Thrust Bearings For Coil-Over Shocks	CQ-010	Upgrade
Spanner Wrench	TA-001	Upgrade

#### ADDITIONAL OPTIONS

Description	Part#	
62-65 Nova Steel Inner Fender Panels	CX-327	Upgrade
66-67 Nova Steel Inner Fender Panels	CX-328	Upgrade
62-67 Nova Swaybar 1 1/4 Spline	SB-403	Upgrade
Steering Hookup Kit	SC-307	Upgrade

# '62-'67 NOVA

## 4-LINK KIT FOR NOVA REAR



Owner/Builder:  
Bill Jelinek  
Route 66 Motorsports

**INCLUDED IN BASE KIT:**  
• 4-Link Chassis and Axle Brackets •  
• Top Crossmember • Panhard Bar •  
• Subframe Connectors • Standard Black  
Coil-Over Shocks and Black Springs

Now Available!  
Double Adjustable  
Shocks

### COMPLETE BASE KIT

#### COMPLETE BASE KIT

Description	Part#
62-67 Nova Weld-In	RN-101
62-67 Nova Bolt-In	RN-101-B

#### SHOCK & SPRING OPTIONS

Description	Part#	
Black Coil-Over Shocks	CO-101	Included
250#, 300#, 350# Black Coil Springs	CR-XXX-11-B	Included
Single Adjustable Billet Coil-Over Shocks	CB-105	Upgrade
Double Adjustable Billet Coil-Over Shocks	CB-105-D	Upgrade
250#, 300#, 350# Silver Powder Coated Springs w/CB-105	CSV-XXX-11	Included

#### LINKS & PANHARD BAR OPTIONS

Description	Part#	
Plain 4 Links and Bar Kit	RN-051	Included
Polished Stainless Steel 4 Links and Bar Kit	RN-052	Upgrade

#### SUBFRAME CONNECTORS

Description	Part#	
Subframe Connectors	RN-050	Included

#### AXLE HOUSING AND AXLE OPTIONS

Description	Part#	
Housing With Brackets Installed	RN-013-55-H	Upgrade
31 Spline Axles - Chevy Bolt Pattern - 55" Track Width	RN-014-55-31	Upgrade
31 Spline Axles - Ford Bolt Pattern - 55" Track Width	RN-014-55-31-F	Upgrade

#### 3RD MEMBER OPTIONS

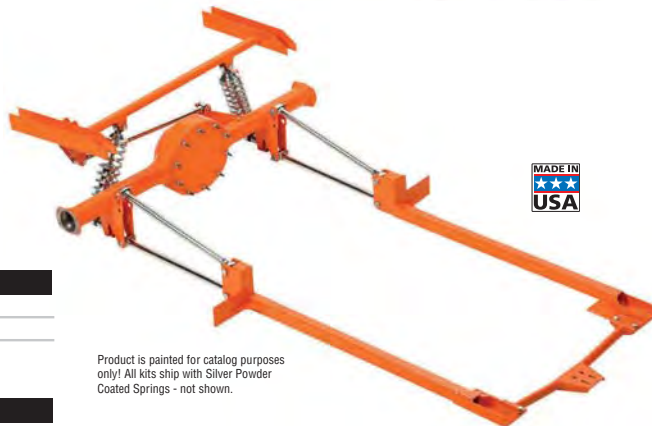
Description	Part#	
Open 31 Spline 3.00, 3.25, 3.50, 3.70, 3.90, 4.11 Ratio	BN-XXX-I	Upgrade
Positraction 31 Spline 3.00, 3.25, 3.50, 3.70, 3.90, 4.11 Ratio	BN-XXX-I-L	Upgrade

#### BRAKE OPTIONS

Description	Part#	
11" Heavy Duty Drum Brake	RN-054	Upgrade
12" Iron Rotors, GM Single Piston Calipers W/Parking Brake	DRE-005-E-P	Upgrade
12" Wilwood Smooth Rotors & 4 Piston Black Calipers W/Parking Brake	DRE-005-P-B	Upgrade
12" Wilwood Smooth Rotors & 4 Piston Red Calipers W/Parking Brake	DRE-005-P-RED	Upgrade
12" Wilwood Smooth Rotors & 4 Piston Polished Calipers W/Parking Brake	DRE-005-P	Upgrade
12" Wilwood Drilled Rotors & 4 Piston Black Calipers W/Parking Brake	DRE-005-P-D-B	Upgrade
12" Wilwood Drilled Rotors & 4 Piston Red Calipers W/Parking Brake	DRE-005-P-D-RED	Upgrade
12" Wilwood Drilled Rotors & 4 Piston Polished Calipers W/Parking Brake	DRE-005-P-D	Upgrade

#### ADDITIONAL OPTIONS

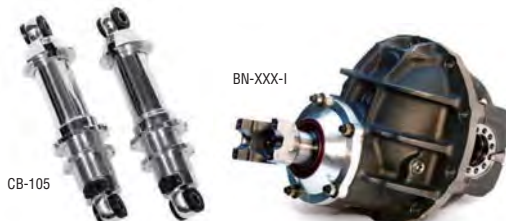
Description	Part#	
62-67 Nova Trans Crossmember	RN-053	Upgrade
62-67 Nova Drive Shaft Hoop	RN-057	Upgrade
62-67 Nova Rear Swaybar (For Use With HEIDTS® 4-Link Kit Only)	SB-130	Upgrade



Product is painted for catalog purposes only! All kits ship with Silver Powder Coated Springs - not shown.



RN-052



CB-105

BN-XXX-I



CSV-XXX-11



RN-014-55-31



RN-054



DR-XXX-P



RN-053

# '62-'67 & '68-74 NOVA



## HEIDTS PRO-G IRS

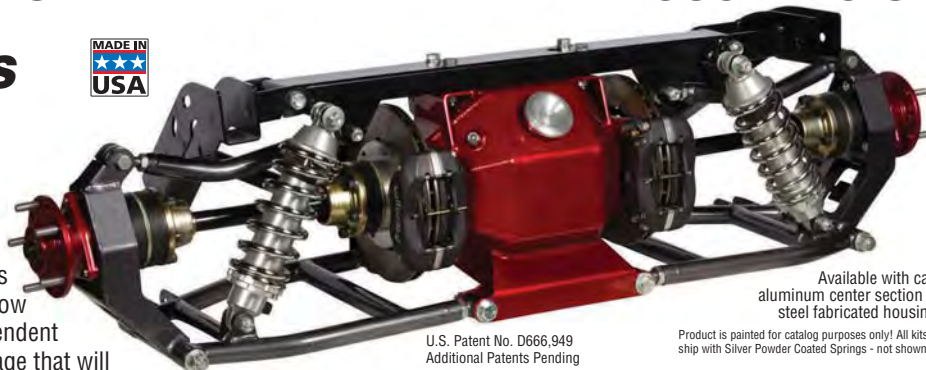
### HIGH HORSEPOWER INDEPENDENT REAR SUSPENSION

#### WHY HEIDTS PRO-G® IRS



Do you really want to go fast and out-handle everyone else on the autocross or road race course in your Nova? Full independent rear suspension is the only way to go. HEIDTS® now has a High Horsepower Independent Rear Suspension bolt-In Package that will do the job just fine.

*It is a true high horsepower package, with upper links and heavy duty CV joints. The upper link produces -.5° of camber curve at 3/4 of total travel, during very high cornering loads. Forward struts, attached to the sub-frame connectors insures the wheels stay in place during hard acceleration.*



U.S. Patent No. D666,949  
Additional Patents Pending

Available with cast aluminum center section or steel fabricated housing.  
Product is painted for catalog purposes only! All kits ship with Silver Powder Coated Springs - not shown.

#### COMPLETE BASE KIT



\*Subframe Connectors Included.

Now Available!  
Double Adjustable Shocks

#### WHAT YOU GET:

- Track Width 56 1/2"
- 9" Aluminum HSG.
- 3rd Member, Iron, Posi
- CV Joint Halfshafts
- Tubular Upper & Lower Arms
- Steel Outer Uprights
- Top Crossmember
- Frame Mounting Brackets
- Front Pinion Support
- Forward Struts\*
- 10.5" Wilwood Rotors
- Black Wilwood Calipers
- Billet Single Adjustable Coil-Overs with Silver Powder Coated Springs
- Posi-Traction

#### OPTIONS: CALL FOR DETAILS.

- Choice of Gear Ratios
- Parking Brake Kit and Cable Kit

#### PARKING BRAKE OPTIONS

Description	Part#
Parking Brake Kit & Cable Kit	PB-101
E-Stop Actuator	BM-013

#### COMPLETE BASE KIT

(500HP and 800HP Options Available)

Description	Part#
62-67 Nova IRS, Plain Rotors	NVR-101
68-74 Nova IRS, Plain Rotors	NVR-301
62-67 Nova IRS, Slotted Rotors	NVR-101-S
68-74 Nova IRS, Slotted Rotors	NVR-301-S

#### SHOCK & SPRING OPTIONS

Description	Part#	
Single Adjustable Billet Coil-Over Shocks	CB-106	Included
Double Adjustable Billet Coil-Over Shocks	CB-106-D	Upgrade
350# Silver Powder Coated Springs	CSV-350-09	Included
400# Silver Powder Coated Springs	CSV-400-09	Included
450# Silver Powder Coated Springs	CSV-450-09	Included
550# Silver Powder Coated Springs	CSV-450-09	Included

#### 3RD MEMBER OPTIONS

Description	Part#	
Positraction 31 Spline 3.00 Ratio	BN-300-I-L	Included
Positraction 31 Spline 3.25 Ratio	BN-325-I-L	Included
Positraction 31 Spline 3.50 Ratio	BN-350-I-L	Included
Positraction 31 Spline 3.70 Ratio	BN-370-I-L	Included
Positraction 31 Spline 3.90 Ratio	BN-390-I-L	Included
Positraction 31 Spline 4.11 Ratio	BN-411-I-L	Included

#### SUBFRAME CONNECTOR

Description	Part#	
62-67 Nova Subframe Connectors - Coupe	NVR-140	Included

#### HOUSING OPTIONS

Description	Part#	
Polished Aluminum 9" Housing	BM-001-P	Upgrade
Steel Fab 9" Housing	BT-410	Upgrade



# '68-'74 NOVA FRONT SUBFRAME WIDE TIRE SERIES

Builder:  
Performance  
Restorations



## INCLUDED IN BASE KIT:

- HEIDTS PRO-G® Subframe
- HEIDTS PRO-G® 2" Dropped Spindles
- Transmission X-Member
- Tubular Upper & Lower Arms
- Power Rack & Pinion Steering
- 11" Wilwood Brakes with Black Calipers
- Billet Coil-Overs, Single Adjustable Shocks with Silver Powder Coated Springs



Now Available!  
Double Adjustable  
Shocks

## COMPLETE SUBFRAME BASE KIT

Description	Part#
68-74 Nova (Includes Trans Crossmember)	CF-101-WT

## CONTROL ARM OPTIONS

Description	Part#	
Control Arms	CF-102	Included
Plain Control Arms 8" Addl. Positive Caster (optional)	CF-102-8-H	Included
Polished Stainless Steel Control Arms	CF-103	Upgrade

## BRAKE OPTIONS

Description	Part#	
11" Wilwood Smooth Rotors & 4 Piston Black Calipers	DFP-221-B	Included
12" Wilwood Drilled Rotors & 4 Piston Black Calipers	DFP-222-D-B	Upgrade
13" Wilwood Drilled Rotors & 6 Piston Black Calipers	DFP-223-D-B	Upgrade

Additional options available. Call for pricing.

## SPINDLE OPTION

Description	Part#	
2" Dropped Spindles	SP-110	Included

## POWER RACK & PINION OPTIONS

Description	Part#	
Power Rack	MP-038-3-K	Included
Power Rack W/ Stainless Steel Tie Rod Ends	MP-038-SS-K	Upgrade

## SHOCK & SPRING OPTIONS

Description	Part#	
Single Adjustable Billet Coil-Over Shocks	CB-160	Included
Double Adjustable Billet Coil-Over Shocks	CB-160-D	Upgrade
400#, 450#, 500#, 550#, 600#, 700# Powder Coated 10" Springs	CSV-XXX-10	Included
Spanner Wrench	TA-001	Upgrade

## ADDITIONAL OPTIONS

Description	Part#	
Upper Arm "Heim Style" Adjuster Kit	CF-104	Upgrade
68-72 Nova Pre Bent Brake Line Kit	CF-111	Upgrade
Steering Hookup Kit For Power Rack DD	SC-298	Upgrade
1" Swaybar	SB-110	Upgrade
1-1/4" Swaybar	SB-111	Upgrade
1-1/4" Splined Swaybar	SB-401	Upgrade
68-74 Nova Subframe Connectors	RN-056-WT	Upgrade
68-74 Nova Drive Shaft Hoop (Subframe Connectors Required)	RC-037	Upgrade
Body Mount Kit Urethane Bushings	CF-106	Upgrade
Body Mount Kit Aluminum Bushings	CF-109	Upgrade
Motor Mount Stands	MM-220	Included
Thrust Bearings For Coil Over Shocks	CQ-010	Upgrade

HEIDTS® now offers their bolt on front subframe. Featuring their new **HEIDTS Pro-G®** suspension package for unbelievable cornering and overall handling. Simply unbolt and remove your front sheetmetal, engine/trans, old subframe, then slide in the new complete **HEIDTS®** Subframe. Reinstall your engine/trans and sheetmetal. **HEIDTS®** makes high end handling affordable!

## BOLT A "PRO-G®" ON YOUR CAR



'70-'81 CAMARO SHOWN. Product is painted for catalog purposes only!



PACKAGES SHIP UNASSEMBLED  
VIA TRUCK FRIEGHT.

Product is painted for catalog purposes only! All kits ship with Silver Powder Coated Springs - not shown.  
\*Airbags will not fit.



CF-103

SP-110



DF-202

DF-208

DF-206-B-K



MP-038-3-K



CB-160



Order/Tech: 800-841-8188

HEIDTS® MUSCLE CAR PARTS

# '68-'72 NOVA

PACKAGES SHIP UNASSEMBLED  
VIA TRUCK FRIEGHT.

## HEIDTS PRO G 4-LINK KIT FOR NOVA REAR

Builder:  
Performance  
Restorations



Now Available!  
Double Adjustable  
Shocks

Bolt-on maxium performance for your Nova. Kit includes chassis and axle brackets, adjustable links, full upper coil-over crossmember, panhard bar, adjustable HEIDTS® coil-overs and all hardware. Completely bolt-on, with no cutting or floor modifications. Adjustable 4-link mounts allow suspension tuning.

### BOLT-IN REAR 4-LINK KIT



Product is painted for catalog purposes only! All kits ship with Silver Powder Coated Springs - not shown.



RC-107



CO-101

CR-XXX-11-B



RC-041-60-31



BN-XXX-I



RN-054



DR-005-P

### INCLUDED IN BASE KIT:

- 4-Links with Spherical Bearings and Axle Brackets
- Top Crossmember
- Panhard Bar
- Standard Coil-Over Shocks, Black Body and Black Springs

### COMPLETE 4-LINK BASE KIT

Description	Part#
68-72 Nova	RC-131-WT
68-72 Nova (Use If Ordering 9" Housing)	RC-131-WT-H

### LINKS & PANHARD BAR OPTIONS

Description	Part#	
Plain Links and Panhard Bar	RC-106	Included
Polished Stainless Steel Links and Panhard Bar	RC-107	Upgrade

### SHOCK & SPRING OPTIONS

Description	Part#	
Black Coil-Over Shocks	CO-101	Included
250#, 300#, 350# Black Coil Springs	CR-XXX-11-B	Included
Single Adjustable Billet Coil-Over Shocks	CB-105	Upgrade
Double Adjustable Billet Coil-Over Shocks	CB-105-D	Upgrade
250#, 300#, 350# Silver Powder Coated Springs	CSV-XXX-10	Included
Spanner Wrench	TA-001	Upgrade

### AXLE HOUSING AND AXLE OPTIONS

Description	Part#	
60" Track Width Housing With Brackets Installed	RC-040-60-H-WT	Upgrade
60" Track Width 31 Spline Axles with Chevy Bolt Pattern	RC-041-60-31	Upgrade
58" Track Width Housing With Brackets Installed	RC-040-58-H-WT	Upgrade
58" Track Width 31 Spline Axles with Chevy Bolt Pattern	RC-041-58-31	Upgrade

### 3RD MEMBER OPTIONS

Description	Part#	
Open 31 Spline 3, 3.25, 3.50, 3.70, 3.90, 4.11 Ratio	BN-XXX-I	Upgrade
Positraction 31 Spline 3, 3.25, 3.50, 3.70, 3.90, 4.11 Ratio	BN-XXX-I-L	Upgrade

### BRAKE OPTIONS

Description	Part#	
11" Heavy Duty Drum Brake	RN-054	Upgrade
12" Iron Rotors, GM Single Piston Calipers W/Parking Brake	DR-005-E-P	Upgrade
12" Wilwood Smooth Rotors & 4 Piston Black Calipers W/Parking Brake	DRE-005-P-B	Upgrade
12" Wilwood Smooth Rotors & 4 Piston Red Calipers W/Parking Brake	DRE-005-P-RED	Upgrade
12" Wilwood Smooth Rotors & 4 Piston Polished Calipers W/Parking Brake	DRE-005-P	Upgrade
12" Wilwood Drilled Rotors & 4 Piston Black Calipers W/Parking Brake	DRE-005-P-D-B	Upgrade
12" Wilwood Drilled Rotors & 4 Piston Red Calipers W/Parking Brake	DRE-005-P-D-RED	Upgrade
12" Wilwood Drilled Rotors & 4 Piston Polished Calipers W/Parking Brake	DRE-005-P-D	Upgrade

### SUBFRAME CONNECTOR OPTIONS

Description	Part#	
68-72 Nova Subframe Connectors - Factory Subframe	RN-055	Upgrade
68-72 Nova Subframe Connectors (Use with Pro-G®)	RN-056-WT	Upgrade

### ADDITIONAL OPTIONS

Description	Part#	
Rear Sway Bar	SB-009	Upgrade
Spanner Wrench	TA-001	Upgrade

# '55-'57 CHEVY



## TUBULAR UPPER & LOWER CONTROL ARMS

Description	Part#
<b>UPPER</b>	
Plain Control Arms	CA-201
Plain Control Arms With 6 Degrees of Additional Caster	CA-201-6
Polished Stainless Steel Control Arms	CA-201-SS
Polished Stainless Steel Control Arms With 6 Degrees of Additional Caster	CA-201-SS-6
Plain Control Arms- Narrowed	CA-201-N
Stainless Steel Narrowed Control Arms	CA-201-SS-N

<b>LOWER</b>	
*Plain Control Arms, Standsard Shocks and Springs	CA-203
*Plain Control Arms For Coil-Over Shocks	CA-203-M
*Polished Stainless Steel Control Arms	CA-203-SS
*Polished Stainless Steel Control Arms For Coil-Over Shocks	CA-203-SS-M

\* Control Arm work with HEIDTS Spindle Only. Must use Coil Overs with Narrow Arms. Control Arms can be shipped unassembled for powdercoat painting.

## BUSHING & BALL JOINT CAPS

Upper & Lower Control Arm Bushing Caps. Fully polished aluminum, with polished stainless bolts, will fit Tubular Control Arms or stock control arms.

The finishing touch to your suspension. Cover those upper ball joints with our Ball Joint Caps. They are polished stainless steel, including polished screws.

Description	Part#
Stainless Steel Ball Joint Caps (1 Pair)	CA-210
Polished Aluminum Bushing Caps (Complete Set)	CA-211

## COIL-OVERS & 1" DROPPED COIL SPRINGS

HEIDTS® Billet aluminum coil-over shocks are fully adjustable for ride height and dampening. Specifically designed full length conical springs are powder coated bright silver. Two progressive spring rates for big blocks or small blocks. Fits coil-over arms or stock applications.

To give your 'Shoebox' an even lower look, add these HEIDTS® 1" Dropped Coil Springs. The are 1" shorter than New factory springs. Combined with our 2" Dropped Spindles, they will put your cruiser a full 3" in the weeds safely and easily.

Description	Part#
55-57 Chevy Single Adjustable Coil-Over Shocks	CB-120
55-57 Chevy Double Adjustable Coil-Over Shocks	CB-120-D
450# 11" Silver Powder Coat Coil-Over Springs - Small Block	CQ-450-11
550# 11" Silver Powder Coat Coil-Over Springs - Big Block	CQ-550-11
1" Dropped Coil Springs (Factory Style) - Small Block	CS-060
Thrust Bearings For Coil-Over Shocks	CQ-010
Spanner Wrench	TA-001

## STABILIZER BAR KITS

Stabilizer bars, or sway bars, are used to control body roll and sway. HEIDTS® Stabilizer Bars for '55-'57 Chevys are made of heat treated steel. They are available in either 7/8" or 1" bar, with urethane bushings.

Description	Part#
7/8" Front Swaybar With Urethane Bushings	SB-050-U
1" Front Swaybar With Urethane Bushings	SB-051-U
7/8" Rear Swaybar With Urethane Bushings	SB-052



CA-203-SS



CS-060



CA-210

Note: CA-211 is a set of 8 caps!



CQ-450-11

CA-203-SS-M

TA-001



Front Stabilizer Bar Kit

Rear Stabilizer Bar Kit

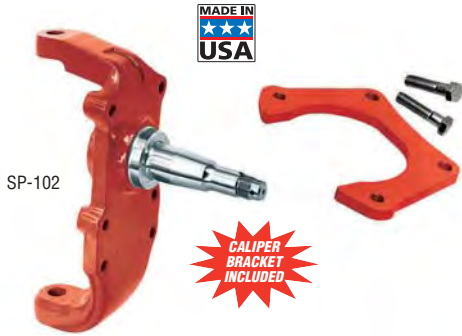
SB-052





# '55-'57 CHEVY

HEIDTS® front suspension components are perfect for lowering, stopping and just flat out making your Tri-Five handle. With our components you will get the look, the stopping power and the handling you deserve.



SP-102



DF-203-B



Early GM Disc Brake Kit

\* Moves wheel out 5/16" from stock loc

DF-203



Late GM Disc Brake Kit



DF-205-D

\* Moves wheel out 7/16" from stock location

## HEIDTS 2" DROPPED STEEL SPINDLE

Our 2" Dropped Spindles are full steel spindles, just like factory spindles. This is much stronger than cast iron. They use your stock steering arms, with no loss of turning radius. No realignment required. The caliper brackets bolt on like mid-70's Chevys, allowing many brake options shown.

Description	Part#
2" Dropped Spindles - Late GM Brackets	SP-102
2" Dropped Spindles (69-72 Calipers) - Early GM Brackets	SP-102-B
2" Dropped Spindles - Use with Wilwood Brake Kits (Each)	SP-002-A

## DISC BRAKE KITS

All the components needed to complete your 2" Dropped Spindle installation for either Late GM or Early GM calipers. Includes rotors, Calipers with Pads, Bearings and Seals, Spindle Nuts, Dust Caps, Hoses and Banjo Bolts. The "Conversion Kit" updates early stock spindle disc brake kits to our 2" spindles. Spindles not included.

Description	Part#
10.5" Rotors, Malibu Single Piston Calipers for HEIDTS® Spindle	DF-203
10.5" Rotors, A-Body Single Piston Calipers for HEIDTS® Spindle	DF-203-B
11" Rotors, A-Body Single Piston Calipers for Stock Spindle	DF-204
11" Wilwood Rotors, 4 Piston Calipers- Forged Dynalite Pro	140-12305
12" Wilwood Drilled Rotors, 4 Piston Calipers- Forged Dynalite Big Front Brake Kit*	140-12306
13" Wilwood Drilled Rotors 6 Piston Calipers- Forged Narrow 6R Big Brake Kit*	140-12307

\*For Heidts® 2" Dropped Spindles

## MISC. BRAKE PARTS

Description	Part#
10.5" Malibu Rotors (79-81)	DF-019
11" Chevelle Rotors (69-72)	DF-046
Malibu Caliper Set (78-84)	DF-009
Caliper Bracket Kit For Stock Spindles	DF-104
11" Caliper Bracket Kit For Wilwood Calipers	DF-105
12" Caliper Bracket Kit For Wilwood Calipers	DF-106

# '55-'57 CHEVY TRIANGULAR 4-LINK

HEIDTS® '55-'57 Chevy Triangulated 4-Link Kit is a very popular kit as it does not require a Panhard Rod. Bars are fully adjustable, 1-1/4" X .156 tube with 3/4" stainless adjusters and urethane bushings, angled and straight chassis brackets, tabs and hardware.

These kits are available in plain steel or polished stainless steel tubes.  
NOTE: Intended for stock or aftermarket frames.



## INCLUDED IN BASE KIT:

- 4-Link Chassis and Axle Brackets
- Top Crossmember
- Standard Black Coil-Over Shocks and Black Springs

Now Available!  
Double Adjustable  
Shocks

## COMPLETE BASE KIT

Description	Part#
55-57 Chevy	RC-151
55-57 Chevy (Use if Ordering 9" Housing)	RC-151-H

## LINKS & PANHARD BAR OPTIONS

Description	Part#	
Plain 4 Links and Bar Kit	RC-152	Included
Polished Stainless Steel 4 Links and Bar Kit	RC-153	Upgrade

## SHOCK & SPRING OPTIONS

Description	Part#	
Black Coil-Over Shocks	CO-101	Included
250#, 300#, 350# Black Coil Springs	CS-XXX-11-B	Included
Single Adjustable Billet Coil-Over Shocks	CB-105	Upgrade
Double Adjustable Billet Coil-Over Shocks	CB-105-D	Upgrade
250#, 300#, 350# Silver Powder Coated Coil Springs	CSV-XXX-11	Included

## AXLE HOUSING AND AXLE OPTIONS

Description	Part#	
Housing With Brackets Installed - 58" Track Width	RC-140-58-H	Upgrade
Housing With Brackets Installed - 60" Track Width	RC-140-60-H	Upgrade
55" Track Width 31 Spline Axle with Chevy Bolt Pattern	RC-041-55-31	Upgrade
56" Track Width 31 Spline Axle with Chevy Bolt Pattern	RC-041-56-31	Upgrade
58" Track Width 31 Spline Axle with Chevy Bolt Pattern	RC-041-58-31	Upgrade
59" Track Width 31 Spline Axle with Chevy Bolt Pattern	RC-041-59-31	Upgrade
60" Track Width 31 Spline Axle with Chevy Bolt Pattern	RC-041-60-31	Upgrade

## 3RD MEMBER OPTIONS

Description	Part#	
Open 31 Spline 3.00, 3.25, 3.50, 3.70, 3.90, 4.11 Ratio	BN-XXX-I	Upgrade
Positraction 31 Spline 3.00, 3.25, 3.50, 3.70, 3.90, 4.11 Ratio	BN-XXX-I-L	Upgrade

## BRAKE OPTIONS

Description	Part#	
11" Heavy Duty Drum Brake	RN-054	Upgrade
12" Iron Rotors, GM Single Piston Calipers W/Parking Brake	DR-005-E-P	Upgrade
12" Wilwood Smooth Rotors & 4 Piston Black Calipers W/Parking Brake	DRE-005-P-B	Upgrade
12" Wilwood Smooth Rotors & 4 Piston Red Calipers W/Parking Brake	DRE-005-P-RED	Upgrade
12" Wilwood Smooth Rotors & 4 Piston Polished Calipers W/Parking Brake	DRE-005-P	Upgrade
12" Wilwood Drilled Rotors & 4 Piston Black Calipers W/Parking Brake	DRE-005-P-D-B	Upgrade
12" Wilwood Drilled Rotors & 4 Piston Red Calipers W/Parking Brake	DRE-005-P-D-RED	Upgrade
12" Wilwood Drilled Rotors & 4 Piston Polished Calipers W/Parking Brake	DRE-005-P-D	Upgrade

## SWAYBAR OPTIONS

Description	Part#	
Plain Swaybar	SB-180	Upgrade
Chrome Swaybar	SB-180-C	Upgrade

\*MUST USE FORD 9" HOUSING\*



Shown with options.  
Product is painted for  
catalog purposes only!



RC-140-60-H



BN-XXX-I



CO-101

CR-XXX-11-B



RC-041-60-31



RN-054

DR-005-P



# '55-'57 CHEVY

## HEIDTS PRO-G® IRS

### BOLT-IN INDEPENDENT REAR SUSPENSION



Now Available!  
Double Adjustable  
Shocks



Patent Pending



#### COMPLETE BASE KIT

Product is painted for catalog purposes only! All kits ship with Silver Powder Coated Springs - not shown.



The Tri-Five **HEIDTS Pro-G®** IRS is a true bolt-in, high horsepower Independent Rear Suspension System for 1955 through 1957 Chevy cars. This industry-leading design is based off the proven and award-winning **HEIDTS Pro-G®** IRS geometry, while the bolt-in design means it can be installed on cars that are already complete or easily added to builds already underway. The Tri-Five **HEIDTS Pro-G®** IRS also features several design enhancements to make exhaust routing easier.

#### INCLUDED IN BASE KIT:

- Top Crossmembers • Upper & Lower Arms
- Aluminum Uprights • CV Joint Halfshafts
- 9" Aluminum Housing • 3rd Member, Iron, Posi
- 10.5" Wilwood Rotors with 4 Piston Polished Calipers
- Billet Single Adjustable Coil-Over Shocks with Silver Powder Coated Springs

Also available in fully polished version as shown. Call for details.

#### COMPLETE BASE KIT

Description	Part#
55-57 CHEVY High Horsepower IRS - Plain Rotors	IRS-151
55-57 CHEVY High Horsepower IRS - Drilled Rotors	IRS-151-S
55-57 CHEVY High Horsepower IRS - Polished Pkg. - Smooth Rotors	IRS-151-P
55-57 CHEVY High Horsepower IRS- Polished Pkg- Drilled Rotors	IRS-151-S-P

#### SHOCK & SPRING OPTIONS

Description	Part#	
Single Adjustable Billet Coil-Over Shocks	CB-106	Included
Double Adjustable Billet Coil-Over Shocks	CB-106-D	Upgrade
350# Silver Powder Coated Springs	CSV-350-09	Included
400# Silver Powder Coated Springs	CSV-400-09	Included
450# Silver Powder Coated Springs	CSV-450-09	Included
550# Silver Powder Coated Springs	CSV-550-09	Included

#### 3RD MEMBER OPTIONS

Description	Part#	
Positraction 31 Spline 3.00 Ratio	BN-300-I-L	Included
Positraction 31 Spline 3.25 Ratio	BN-325-I-L	Included
Positraction 31 Spline 3.50 Ratio	BN-350-I-L	Included
Positraction 31 Spline 3.70 Ratio	BN-370-I-L	Included
Positraction 31 Spline 3.90 Ratio	BN-390-I-L	Included
Positraction 31 Spline 4.11 Ratio	BN-411-I-L	Included

#### HOUSING OPTIONS

Description	Part#	
Polished Aluminum 9" Housing	BM-001-P	Upgrade
Steel Fab 9" Housing	BT-410	Upgrade



# HEIDTS PRO-G IRS

## UNIVERSAL HIGH HORSEPOWER INDEPENDENT REAR SUSPENSION

### WHY HEIDTS PRO-G<sup>®</sup> IRS

HEIDTS<sup>®</sup> now has a High Horsepower Independent Rear Suspension bolt-In Package for almost any car. For those of you who want ultra modern handling in your classic car can now have it with this fully independent suspension. This full independent rear suspension is the only way to go.

*It is a true high horsepower package, with upper links and heavy duty CV joints. The upper link produces  $-.5^{\circ}$  of camber curve at 3/4 of total travel, especially during very high cornering loads. Forward struts, attached to the sub-frame connectors insures the wheels stay in place during hard acceleration.*



U.S. Patent No. D666,949  
Additional Patents Pending

Product is painted for catalog purposes only! All kits ship with Silver Powder Coated Springs - not shown.

**Now Available!**  
Double Adjustable  
Shocks

#### COMPLETE BASE KIT

Description	Part#
Universal High Horsepower IRS 56" or 58" Track- Plain Rotors	IRU-58
Universal High Horsepower IRS - Drilled & Slotted Rotors	IRU-58-D

#### SHOCK & SPRING OPTIONS

Description	Part#	
Single Adjustable Billet Coil-Over Shocks	CB-106	Included
Double Adjustable Billet Coil-Over Shocks	CB-106-D	Upgrade
350# Silver Powder Coated Springs w/CB-106	CSV-350-09	Included
400# Silver Powder Coated Springs w/CB-106	CSV-400-09	Included
450# Silver Powder Coated Springs w/CB-106	CSV-450-09	Included
550# Silver Powder Coated Springs w/CB-106	CSV-550-09	Included

#### 3RD MEMBER OPTIONS

Description	Part#	
Positraction 31 Spline 3.00 Ratio	BN-300-I-L	Included
Positraction 31 Spline 3.25 Ratio	BN-325-I-L	Included
Positraction 31 Spline 3.50 Ratio	BN-350-I-L	Included
Positraction 31 Spline 3.70 Ratio	BN-370-I-L	Included
Positraction 31 Spline 3.90 Ratio	BN-390-I-L	Included
Positraction 31 Spline 4.11 Ratio	BN-411-I-L	Included

#### PARKING BRAKE OPTIONS

Description	Part#	
Parking Brake Kit & Cable Kit - Black	PB-101	Upgrade
Parking Brake Kit & Cable Kit - Silver	PB-101-S	Upgrade
E-Stop Actuator	BM-013	Upgrade

#### HOUSING OPTIONS

Description	Part#	
Polished Aluminum 9" Housing	BM-001-P	Upgrade
Steel Fab 9" Housing	BT-410	Upgrade

### WHAT YOU GET:

- Track Width 56 1/2" or 58 1/2"
- 9" Aluminum HSG.
- 3rd Member, Iron, Posi
- CV Joint Halfshafts
- Tubular Upper & Lower Arms
- Steel Outer Uprights
- Top Crossmember
- Frame Mounting
- Brackets
- Front Pinion Support
- Forward Struts\*
- 10.5" Wilwood Rotors
- Black Wilwood Calipers
- Billet Single Adjustable Coil-Overs with Silver Powder Coated Springs
- Posi-Traction
- Step-By-Step Instructions

### OPTIONS: CALL FOR DETAILS.

- Choice of Gear Ratios
- Parking Brake Kit and Cable Kit



**"About once every ten years, someone comes up with a breakthrough part in the aftermarket. The HEIDTS<sup>®</sup> Bolt-in Independent Rear suspension could be that part for 2011 and beyond!"**

Quoted from Jim Campisano - Editor Super Chevy Magazine, January Issue



**Order/Tech: 800-841-8188**

HEIDTS<sup>®</sup> MUSCLE CAR PARTS

# RIGHT HAND DRIVE MUSCLE CAR SUSPENSION KITS



## DRIVE RIGHT - DRIVE HEIDTS!



**HEIDTS®** Right Hand Suspension Systems will give your Muscle Car the ride, handling and stopping power you are after (Comes standard with dropped spindles). Assembled package is shown so you can see what your completed front end will look like.

**Now Available!  
Dually Adjustable  
Shocks**



CF-101-WT-RH

### 67-81 CAMARO PRO-G® RIGHT HAND DRIVE, POWER ONLY

Description	Part#
67-69 Camaro	CF-101-WT-RH
70-81 Camaro	CF-201-WT-RH

Product is painted for catalog purposes only! All kits ship with Silver Powder Coated Springs - not shown.



CX-320-S-K-RH

### 62-73 NOVA RIGHT HAND DRIVE FRONT SUBFRAMES, POWER ONLY

Description	Part#
62-67 Nova Mustang II RH	CX-320-S-K-RH
62-67 Nova Superide II RH	BX-320-RH
62-67 Nova Pro-G® RH	NVF-320-RH
68-73 Nova Pro-G® RH	CF-101-WT-RH

Product is painted for catalog purposes only! All kits ship with Silver Powder Coated Springs - not shown.



MTF-101-RH

### 64-1/2 - 70 MUSTANG RIGHT HAND DRIVE POWER ONLY

Description	Part#
64-1/2 - 70 Mustang, Mustang II	PX-320-E-K-RH
64-1/2 - 70 Mustang Superide II	BX-340-RH
64-1/2 - 70 Mustang Pro-G®	MTF-101-RH

Product is painted for catalog purposes only! All kits ship with Silver Powder Coated Springs - not shown.



BX-601-RH

### FALCON, COMET, AND FAIRLANE RIGHT HAND DRIVE, POWER ONLY

Description	Part#
62-65 Falcon Mustang II	PX-330-E-K
66-67 Fairlane/Comet Superide II	BX-601-RH

Product is painted for catalog purposes only! All kits ship with Silver Powder Coated Springs - not shown.



# RIGHT HAND DRIVE STREET ROD SUSPENSION KITS



## INCLUDED IN BASE KITS:

- HEIDTS® Crossmember
- Tubular Upper & Lower Arms
- Stock Mustang II Spindles
- Manual Rack & Pinion Steering
- 11" Rotors with 4 Piston Wilwood Calipers
- Billet Single Adjustable Coil-Over Shocks with Silver Powder Coated Springs

Now Available!  
Double Adjustable  
Shocks



## SUPERIDE RIGHT HAND DRIVE REAR STEER MANUAL ONLY

Description	Part#
Superide Openwheel for pinched rails	BX-105-RH
28-31 Ford Superide	BX-101-RH
32 Ford Superide	BX-102-RH
33-34 Ford Superide	BX-103-RH
28-35 Chevy Superide	BX-114-RH

Product is painted for catalog purposes only! All kits ship with Silver Powder Coated Springs - not shown.



BX-102-RH

## STREET ROD SUPERIDE II RIGHT HAND DRIVE FRONT STEER POWER ONLY

Description	Part#
35-40 Ford Superide II	BX-202-RH
41-48 Ford Superide II	BX-203-RH
37-41 Willys Superide II	BX-211-RH
37-39 Chevy Superide II	BX-212-RH
40-48 Chevy Superide II	BX-213-RH
40-46 Chevy Pick up Superide II	BX-305-RH
47-54 Chevy Pick up Superide II	BX-306-RH

Product is painted for catalog purposes only! All kits ship with Silver Powder Coated Springs - not shown.



BX-202-RH

## CLASSIC TRUCK SUPERIDE II RIGHT HAND DRIVE FRONT STEER, 60" TRACK POWER ONLY

Description	Part#
55-59 Chevy Pick up	BX-307-RH
48-52 Ford F-1	BX-310-RH
53-63 Ford F-1	BX-316-RH

Product is painted for catalog purposes only! All kits ship with Silver Powder Coated Springs - not shown.



BX-307-RH

## STREET ROD MUSTANG II RIGHT HAND DRIVE FRONT STEER POWER ONLY

Description	Part#
34-35 Chevy standard	CX-101-E-K-RH
37-39 Chevy	CX-102-E-K-RH
40-48 Chevy	CX-103-E-K-RH
49-54 Chevy	CX-104-E-K-RH
34-36 Chevy Master	CX-111-E-K-RH
37-39 Chevy Pick Up	CX-305-E-K-RH
40-46 Chevy Pick Up	CX-306-E-K-RH
47-54 Chevy Pick Up	CX-307-E-K-RH
55-59 Chevy Pick Up 60" track	CX-308-E-K-RH
Universal 56-1/2" track	KX-101-E-K-RH
Universal 60" track	KX-102-E-K-RH
33-34 Ford	PX-101-E-K-RH
35-40 Ford	PX-102-E-K-RH
41-48 Ford	PX-103-E-K-RH
48-52 Ford F-1, 60" track	PX-104-E-K-RH
53-63 Ford F-1, 60" track	PX-105-E-K-RH

Product is painted for catalog purposes only! All kits ship with Silver Powder Coated Springs - not shown.



BX-101-E-K-RH



Order/Tech: 800-841-8188

HEIDTS® STREET ROD PARTS



# HEIDTS SUPERIDE® IRS

MADE FOR BOTH HOT ROD & MUSCLE CAR APPLICATIONS!



U.S. Patent No. D666,949  
Additional Patents Pending

Product is painted for catalog purposes only! All kits ship with Silver Powder Coated Springs - not shown.

Get the best handling for your Street Rod or Muscle Car with **HEIDTS SUPERIDE®** Independent rear suspension kit. The best riding and handling IRS to combine with your SUPERIDE® IFS to make your Street Rod or Muscle Car a first class ride. The geometry is designed to be compatible with all of our independent front suspensions, as well as most other independent front suspension kits. It is a complete kit, hub to hub and with added options your Street Rod or Muscle Car will be the hottest ride in town.

### INCLUDED IN BASE KIT:

- Top Crossmembers • Lower Arms
- Aluminum Uprights • 2" Half Shafts
- 9" Aluminum Housing • 3rd Member, Iron, Open
- 10.5" Wilwood Rotors with 4 Piston Polished Calipers
- Billet Single Adjustable Coil-Over Shocks with Silver Powder Coated Springs



### COMPLETE BASE KIT

Available Track Widths: 55", 56", 58", 60", 62"

Description	Part#
Plain Rotors	BR-101
Drilled Rotors	BR-101-D

### HOUSING OPTIONS

Description	Part#	
Plain Housing	BM-001	Included
Polished Housing	BM-001-P	Upgrade

### UPRIGHTS OPTIONS

Description	Part#	
Plain Uprights, Plain Bearings, 4.75 Bolt Pattern	BM-002	Included
Plain Uprights, Chrome Bearings, 4.75 Bolt Pattern	BM-002-C	Upgrade
Plain Uprights, Plain Bearings, 4.50 Bolt Pattern	BM-002-F	Upgrade
Plain Uprights, Chrome Bearings, 4.50 Bolt Pattern	BM-002-F-C	Upgrade
Polished Uprights, Plain Bearings, 4.75 Bolt Pattern	BM-002-P	Upgrade
Polished Uprights, Chrome Bearings, 4.75 Bolt Pattern	BM-002-P-C	Upgrade
Polished Uprights, Plain Bearings, 4.50 Bolt Pattern	BM-002-F-P	Upgrade
Polished Uprights, Chrome Bearings, 4.50 Bolt Pattern	BM-002-F-P-C	Upgrade

### PINION SUPPORT & STRUTS OPTIONS

Description	Part#	
Plain Pinion Support & Struts	BM-003	Included
Polished Pinion Support & Struts	BM-003-P	Upgrade

### CONTROL ARM OPTIONS

Description	Part#	
Lower Arms	BM-004-XX	Included
Polished Lower Arms	BM-004-XX-P	Upgrade
Plain Lower Arms, Dual Shocks	BM-004-XX-D	Upgrade
Polished Lower Arms, Dual Shocks	BM-004-XX-P-D	Upgrade

XX = Track Width Available: 55", 56", 58", 60", 62"

# OPTIONS

## HEIDTS SUPERIDE® IRS

Owner: Don Barnes, The Performance Center



HEIDTS® STREET ROD PARTS

### CROSSMEMBER OPTIONS

Description	Part#	
28", 32", 36", 40" Crossmember & Plain Forward Struts	BM-005-XX	Included
28", 32", 36", 40" Crossmember & Polished Forward Struts	BM-005-XX-P	Upgrade
Crossmember, Model A, Plain Forward Struts	BM-005-28	Upgrade
Crossmember, Model A, Stainless Steel Forward Struts	BM-005-28-P	Upgrade
32" Crossmember for 56" Track Width & Plain Struts	BM-005-32	Upgrade
32" Crossmember for 56" Track Width & Polished Struts	BM-005-32-P	Upgrade
Special Crossmember	BM-005-SPEC	Upgrade

XX = Crossmember Width



Polished Stainless Lower Arms with Polished Adjusters and Polished Stainless Tie Bars, Polished Center Housing, Polished Outer Uprights

### HALF SHAFT OPTIONS

Description	Part#	
2" Plain Half Shafts	BM-006-XX	Included
2" Chrome Half Shafts	BM-006-XX-C	Upgrade
2" Chrome Half Shafts W/Chrome U-joints	BM-006-XX-C-X	Upgrade
3" Heavy Duty Plain Half Shafts	BM-006-XX-3	Upgrade
3" Heavy Duty Chrome Half Shafts	BM-006-XX-3-C	Upgrade

Chrome U-joint not available with 3" chrome half shafts.

XX = Track Width Available: 55", 56", 58", 60", 62"



### HIGH HORSEPOWER HALF SHAFTS

Designed for muscle car and heavy car applications. 3" dia. tubes will take extra torque loads.

### COIL-OVER SHOCK OPTIONS

Description	Part#	
Single Adjustable Billet Coil-Over Shocks	CB-101	Included
Double Adjustable Billet Coil-Over Shocks	CB-101-D	Upgrade
Polished Billet Coil-Over Shocks	CB-101-P	Upgrade

### COIL-OVER SPRING OPTIONS

Description	Part#	
450#, 500#, 550#, 600#, 700# Silver Powder Coated 8" Springs	CSV-XXX-08	Included

### 3RD MEMBER OPTIONS

Description	Part#	
Open 31 Spline Any Ratio	BN-XXX-I	Included
Positraction 31 Spline Any Ratio	BN-XXX-I-L	Upgrade
Open 31 Spline Any Ratio, Aluminum Case	BN-XXX-P	Upgrade
Positraction 31 Spline Any Ratio, Aluminum Case	BN-XXX-P-L	Upgrade
3rd Member Case - Use w/ Polished Aluminum Case	BN-001	Upgrade

Now you can complete your parking brake cable hook-up with HEIDTS® new E-Brake Bracket and Cable Kit. The complete kit consists of Lokar's 10' Universal Black Parking Brake Cable set and HEIDTS® bolt-on Brackets. They bolt right on to the parking calipers, and the cables complete the installation easily. The brackets are available separately.

### PARKING BRAKE OPTIONS

Description	Part#	
Polished Pinion Yoke With Chrome U-Bolts	BT-063-P	Upgrade
Parking Brake Kit & Cable Kit - Black	PB-101	Upgrade
Parking Brake Kit & Cable Kit - Silver	PB-101-S	Upgrade
E-Stop Actuator	BM-013	Upgrade

Now Available!  
Double Adjustable  
Shocks



Order/Tech: 800-841-8188

# '55-'57 Chevy Frames



New from Heidts, full custom frames for the '55-'57 Chevy. Heidts Tri 5 frames come fully assembled with our PRO-G front suspension and either 4 link rear suspension or PRO-G IRS. Frame comes standard with adjustable coilover shocks, Wilwood brakes, power steering, 2" drop spindles and 3rd member. We also offer brake lines, motor mounts and gas tanks already installed. For more information and pricing, please call 800-841-8188

### COMPLETE BASE KIT

Description	Part#
'55-'57 Chevy Frame	HF-200

### SPINDLE OPTION

Description	Part#
Drop Spindle	SP-101

### FRONT SHOCK & SPRING OPTIONS

Description	Part#
Single Adjustable Billet Coil-Over Shocks (400#, 450#, 500#, 550#)	CB-160
Double Adjustable Billet Coil-Over Shocks (400#, 450#, 500#, 550#)	CB-160-D

### BRAKE OPTIONS

Description	Part #
Wilwood 11" Rotor with 4 Piston Black Caliper	DFP-221-B
Wilwood 11" Drilled Rotor with 4 Piston Caliper (choose color)	DF-221-D
Wilwood 12" Drilled Rotors, 4 Piston Calipers (choose color)	DF-222-D
Wilwood 13" Drilled Rotors, 6 Piston Calipers (choose color)	DF-223-D

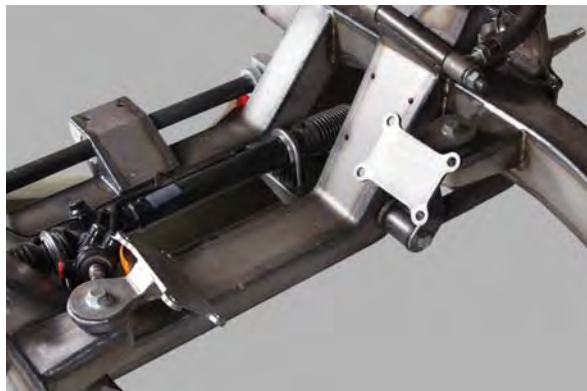
### REAR SHOCKS & SPRINGS

Description	Part #
Plain Billet Coil-Over Shocks (350#, 400#, 450#, 550#)	CB-106

### 3rd MEMBER OPTIONS

Description	Part #
Positraction 31 Spline 9" Gear (choose gearing)	BN-XXX-I-L

**Now Available!**  
Double Adjustable  
Shocks





# '47-54 Chevy Truck Frames



New from Heidts, full custom frames for your 47-54 Chevy Truck. Heidts truck frames come to you fully assembled with our Mustang II independent front suspension and 4 link rear suspension. Choose the shocks, brakes, steering and 3rd member that fit your build. We also offer brake lines, motor mounts and gas tanks installed in our factory. For more information and pricing, please call 800-841-8188

## COMPLETE BASE KIT

Description	Part#
47-54 Chevy Truck Frame, Short Bed	HF-100
47-54 Chevy Truck Frame, Long Bed	HF-200

## SPINDLE OPTION

Description	Part#
Stock Spindle	MP-028
Drop Spindle	SP-101

## FRONT SHOCK & SPRING OPTIONS

Description	Part#
Single Adjustable Billet Coil-Over Shocks (400#, 450#, 500#, 550#)	BS-001
Double Adjustable Billet Coil-Over Shocks	BS-001-D
Polished Billet Coil-Over Shocks (400#, 450#, 500#, 550#)	MP-007-K

## RACK AND PINION OPTION

Description	Part #
Manual Rack and Pinion	MP-018-K
Power Rack and Pinion	MP-038-3-K

## BRAKE OPTIONS

Description	Part #
11" Iron Rotor with 4 Piston Black Caliper	DF-202-C-B
11" Iron Rotor with 4 Piston Polished Caliper	DF-202-C-P
Wilwood 12" Drilled Rotors, 4 Piston Calipers (choose color)	DF-208-P
Wilwood 13" Drilled Rotors, 6 Piston Calipers (choose color)	DF-206-P

## 4 LINK BARS

Description	Part #
Plain Bar	RB-108
Polished Stainless Steel	RB-108-SS

## COILOVER SHOCKS

Description	Part #
Plain Billet Rear Coilover Shocks	CB-105
Black Coilover Shocks	CO-101



*There are many other options available on all of our frames. For more information, or to have a quote put together, please call us at 800-841-8188 to speak with someone in sales.*



**Order/Tech: 800-841-8188**

**HEIDTS® STREET ROD PARTS**

# '32 Ford Car Frame

New from Heidts, full custom frames for the '32 Ford. Heidts '32 frames come loaded with our Superdite IFS and 4 link rear suspension. Frame comes standard with adjustable coilover shocks, tubular control arms, Wilwood brakes, & manual or power steering rack and your choice of a parallel or triangulated 4 link. For more information and pricing, please call 800-841-8188



**Now Available!  
Double Adjustable  
Shocks**

## 4 LINK OPTIONS

Description	Part#
32 Ford-Plain (Triangulated)	RB-202
32 Ford-Polished (Triangulated) Stainless Steel	RB-202-SS
32-34 Ford-Plain (Parallel 4 Link)	RB-102
32-34 Ford-Polished Stainless Steel (Parallel 4 Link)	RB-102-SS

## HOUSINGS, AXLES

Description	Part #
Housing, 9", T.W.	RC-040-XX
Axles, 31 Spline, T.W.	RC-041-XX-31
3RD Member, Iron Open (choose gearing)	BN-350-I
3RD Member, Iron Posi (choose gearing)	BN-350-I-L

## COILOVER CROSSMEMBER, HARDWARE KIT

Description	Part #
32-40 Ford - Plain	HK-049
32-40 Ford - Polished Stainless Steel	HK-049-P
RB-052	RB-052

## COMPLETE BASE KIT

Description	Part#
32 Ford Car	BX-102

## SPINDLE OPTION

Description	Part#
Plain Spindles	BS-007
Polished Stainless Steel Spindles For 12" & 13" Brake Kits	BS-012
Polished Stainless Spindles W/ Stainless Steel Brackets For 11" Kits	BS-012-S

## FRONT SHOCK & SPRING OPTIONS

Description	Part#
Single Adjustable Billet Coil-Over Shocks (400#, 450#, 500#, 550#)	BS-001
Double Adjustable Billet Coil-Over Shocks (400#, 450#, 500#, 550#)	BS-001-D
Polished Billet Coil-Over Shocks (400#, 450#, 500#, 550#)	BS-002

## BRAKE OPTIONS

Description	Part #
Iron 11" Rotor with Wilwood 4 Piston Polish Caliper (Chevy, Ford BP)	BS-008-K
Wilwood 11" Drilled Rotor with 4 Piston Caliper (choose color)	BSS-020-D
Wilwood 12" Drilled Rotors, 4 Piston Calipers (choose color)	DF-209
Wilwood 13" Drilled Rotors, 6 Piston Calipers (choose color)	DFS-207

## RACK & PINION

Description	Part #
Manual Rack & Pinion	BS-004
Manual Rack & Pinion, with SS tie rod ends	BS-004-SS
New Power Rack & Pinion	BS-004-NPS
New Power Rack & Pinion, with SS tie rod ends	BS-004-NPS-SS
Manual Rack & Pinion, billet	BS-004-B
Manual Rack & Pinion, billet, with SS tie rod ends	BS-004-B-SS

## SWAYBAR OPTIONS

Description	Part #
Sway Bar	BS-055
Chrome Sway Bar	BS-055-C

## REAR SHOCKS & SPRINGS

Description	Part #
Plain Billet Coil-Over Shocks (250#, 300#, 350#)	CB-105
Black Coil-Over Shocks (250#, 300#, 350#)	CO-101

## PANHARD BAR OPTIONS

Description	Part #
'32 Ford Plain Panhard Bar	RP-112
'32 Ford Stainless Steel Panhard Bar	RP-112-S



*There are many other options available on all of our frames. For more information, or to have a quote put together, please call us at 800-841-8188 to speak with someone in sales.*

# '33-34 Ford Car Frame

New from Heidts, full custom frames for the '33-34 Ford. Heidts '33-34 frames come loaded with our Superide IFS or Mustang II IFS and your choice of a parallel or triangulated 4 link rear suspension. Superide frames come standard with adjustable coilover shocks, tubular control arms, Wilwood brakes, & manual or power steering rack. For more information and pricing, please call 800-841-8188

## COMPLETE BASE KIT

Description	Part#
'33-34 Ford Car Superide IFS	BX-103
'33-34 Ford Car Mustang II IFS	PX-101-E-K

## SPINDLE OPTION

Description	Part#
Mustang II Stock Spindles	MP-028
Mustang II Drop Spindles	SP-101-K
Superide II Spindle	BS-007

## FRONT SHOCK & SPRING OPTIONS

Description	Part#
Mustang II Springs & Stock Shocks (300#,350#, 375#)	MP-007-XXX
Mustang II Billet Coil-Over Upgrade	MP-050-XXX
Superide Single Adj. Billet Coil-Over Shocks (400#, 450#, 500#, 550#)	BS-001-XXX
Superide Double Adj. Billet Coil-Over Shocks (400#, 450#, 500#, 550#)	BS-001-D-XXX
Polished Billet Coil-Over Shocks, Superide (400#, 450#, 500#, 550#)	BS-002-XXX



## BRAKE OPTIONS

Description	Part #	
Iron 11" Rotor with Wilwood 4 Piston Polish Caliper (Chevy, Ford BP)	BS-008-K	Included
Wilwood 11" Drilled Rotor with 4 Piston Caliper (choose color)	BSS-020-D	Upgrade
Wilwood 12" Drilled Rotors, 4 Piston Calipers (choose color)	DF-209	Upgrade
Wilwood 13" Drilled Rotors, 6 Piston Calipers (choose color)	DFS-207	Upgrade

## RACK & PINION

Description	Part #
Mustang II Manual Rack	MP-018-1-K
Mustang II Power Rack & Pinion	MP-038-3-K
Superide Manual Rack & Pinion	BS-004
Superide Manual Rack & Pinion, with SS Tie Rod Ends	BS-004-SS
Superide Power Rack & Pinion	BS-004-NPS
Superide Power Rack & Pinion, with SS Tie Rod Ends	BS-004-NPS-SS

## SWAYBAR OPTIONS

Description	Part #
Mustang II Swaybar	SB-001
Superide Sway Bar	BS-055

## 4 LINK OPTIONS

Description	Part#
33-34 Ford-Plain (Triangulated)	RB-203
33-34 Ford-Polished (Triangulated) Stainless Steel	RB-203-SS
33-34 Ford-Plain (Parallel 4 Link)	RB-102
33-34 Ford-Polished Stainless Steel (Parallel 4 Link)	RB-102-SS

## HOUSINGS, AXLES

Description	Part #
Housing, 9", T.W.	RC-040-XX
Axles, 31 Spline, T.W.	RC-041-XX-31
3RD Member, Iron Open (choose gearing)	BN-350-I
3RD Member, Iron Posi (choose gearing)	BN-350-I-L

## COILOVER CROSSMEMBER, HARDWARE KIT

Description	Part #
32-40 Ford - Plain	HK-049
32-40 Ford - Polished Stainless Steel	HK-049-P
'32-40 Ford Coilover Crossmember	RB-052



Now Available!  
Double Adjustable  
Shocks

## REAR SHOCKS & SPRINGS

Description	Part #
Plain Billet Coil-Over Shocks (250#, 300#, 350#)	CB-105
Black Coil-Over Shocks (250#, 300#, 350#)	CO-101

## PANHARD BAR OPTIONS

Description	Part #
'33-34 Ford Plain Panhard Bar	RP-113
'33-34 Ford Stainless Steel Panhard Bar	RP-113-S

There are many other options available on all of our frames. For more information, or to have a quote put together, please call us at 800-841-8188 to speak with someone in sales.



Order/Tech: 800-841-8188



# '35-40 Ford Car Frame

New from Heidts, full custom frames for the '35-40 Ford. Heidts '35-40 frames come loaded with our Superide IFS or Mustang II IFS and triangulated 4 link rear suspension. Superide frames come standard with adjustable coilover shocks, tubular control arms, Wilwood brakes, & manual or power steering rack. For more information and pricing, please call 800-841-8188



**Now Available!  
Double Adjustable  
Shocks**

## 4 LINK OPTIONS

Description	Part#
'35-40 Ford-Plain (Triangulated)	RB-104
'35-40 Ford-Polished (Triangulated) Stainless Steel	RB-104-SS

## HOUSINGS, AXLES

Description	Part #
Housing, 9", T.W.	RC-040-XX
Axles, 31 Spline, T.W.	RC-041-XX-31
3RD Member, Iron Open (choose gearing)	BN-350-I
3RD Member, Iron Posi (choose gearing)	BN-350-I-L

## COILOVER CROSSMEMBER, HARDWARE KIT

Description	Part #
32-40 Ford - Plain	HK-049
32-40 Ford - Polished Stainless Steel	HK-049-P
Coil Over Crossmember	RB-052

## COMPLETE BASE KIT

Description	Part#
'35-40 Ford Car Mustang II IFS	PX-102-E-K
'35-40 Ford Car Superide IFS	BX-202

## SPINDLE OPTION

Description	Part#
Mustang II Stock Spindles	MP-028
Mustang II Drop Spindles	SP-101-K

## FRONT SHOCK & SPRING OPTIONS

Description	Part#
Mustang II Springs & Stock Shocks (300#,350#, 375#)	MP-007-XXX
Mustang II Billet Coil-Over Upgrade	MP-050-XXX
Superide Single Adj. Billet Coil-Over Shocks (400#, 450#, 500#, 550#)	BS-001-XXX
Superide Double Adj. Billet Coil-Over Shocks (400#, 450#, 500#, 550#)	BS-001-D-XXX
Polished Billet Coil-Over Shocks, Superide (400#, 450#, 500#, 550#)	BS-002-XXX

## BRAKE OPTIONS

Description	Part #
Iron 11" Rotor with GM Single Piston Caliper (Chevy, Ford BP)	DF-201
Iron 11" Rotor with Wilwood 4 Piston Polish Caliper (Chevy, Ford BP)	BS-008-K
Wilwood 11" Drilled Rotor with 4 Piston Caliper (choose color)	BSS-020-D
Wilwood 12" Drilled Rotors, 4 Piston Calipers (choose color)	DF-209
Wilwood 13" Drilled Rotors, 6 Piston Calipers (choose color)	DFS-207

## RACK & PINION

Description	Part #
Manual Rack & Pinion	MP-018-1-K
Power Rack & Pinion	MP-038-3-K

## SWAYBAR OPTIONS

Description	Part #
Mustang II Swaybar	SB-001
Superide Sway Bar	BS-056
Superide Narrowed Sway Bar	BS-056-N

## REAR SHOCKS & SPRINGS

Description	Part #
Plain Billet Coil-Over Shocks (250#, 300#, 350#)	CB-105
Black Coil-Over Shocks (250#, 300#, 350#)	CO-101

## PANHARD BAR OPTIONS

Description	Part #
'35-40 Ford Plain Panhard Bar	RP-113
'35-40 Ford Stainless Steel Panhard Bar	RP-113-SS

*There are many other options available on all of our frames. For more information, or to have a quote put together, please call us at 800-841-8188 to speak with someone in sales.*

# '40-41 Willy's Frame

New from Heidts, full custom frames for your '40-41 Willy's. Heidts Willy's frame come standard with our Superide II IFS and triangulated 3 link rear suspension. Our Superide frame comes standard with adjustable coilover shocks, tubular control arms, Wilwood brakes, & manual or power steering rack. For more information and pricing, please call 800-841-8188

## COMPLETE BASE KIT

Description	Part#
Willys Superide IFS	BX-211

## SPINDLE OPTION

Description	Part#
Stock Spindle	MP-028
2" Drop Spindle	SP-101

## FRONT SHOCK & SPRING OPTIONS

Description	Part#
Single Adjustable Billet Coil-Over Shocks (400#, 450#, 500#, 550#)	BS-001
Double Adjustable Billet Coil-Over Shocks (400#, 450#, 500#, 550#)	BS-001-D
Polished Billet Coil-Over Shocks (400#, 450#, 500#, 550#)	BS-002-XX

## RACK AND PINION OPTION

Description	Part #
Manual Rack and Pinion	MP-018-1-K
Power Rack and Pinion	MP-038-3-K

## BRAKE OPTIONS

Description	Part #
11" Iron Rotor with Wilwood 4 Piston Black Caliper (black, red, pol)	DF-202-C
11" Wilwood Rotor and 4 Piston Polished Caliper, (black, red, pol)	DFS-202
Wilwood 12" Drilled Rotors, 4 Piston Calipers (choose color)	DF-208-P
Wilwood 13" Drilled Rotors, 6 Piston Calipers (choose color)	DF-206-P

## CONTROL ARMS

Description	Part #
Tubular Control Arms	BS-025
Narrowed Control Arms	BS-025-N

## COILOVER SHOCKS

Description	Part #
Single Adjustable Billet Rear Coil-Over Shocks	CB-105
Black Coil-Over Shocks	CO-101

## SWAYBAR OPTIONS

Description	Part #
Superide Sway Bar	BS-056
Superide Narrowed Sway Bar	BS-056-N

## 4 LINK

Description	Part#
Universal Triangulated 4 Link	RB-201-U

## HOUSINGS, AXLES

Description	Part #
Housing, 9", T.W.	RC-040-XX
Axles, 31 Spline, T.W.	RC-041-XX-31
3RD Member, Iron Open (choose gearing)	BN-350-I
3RD Member, Iron Posi (choose gearing)	BN-350-I-L

## COILOVER CROSSMEMBER, HARDWARE KIT

Description	Part #
Universal - Plain	HK-048
Universal- Polished Stainless Steel	HK-048-P
Coil Over Crossmember	RB-052



Now Available!  
Double Adjustable  
Shocks

## REAR SHOCKS & SPRINGS

Description	Part #
Plain Billet Coil-Over Shocks (250#, 300#, 350#)	CB-105
Black Coil-Over Shocks (250#, 300#, 350#)	CO-101

## PANHARD BAR OPTIONS

Description	Part #
Universal Weld On Plain Panhard Bar	RP-101
Universal Stainless Steel Panhard Bar	RP-101-SS

There are many other options available on all of our frames. For more information, or to have a quote put together, please call us at 800-841-8188 to speak with someone in sales.



# Model A Frame

New from Heidts, full frames for your Model A. Heidts Model A frames come standard with our Superide II IFS and triangulated or parallel 4 link rear suspension. Our Superide frame comes standard with adjustable coilover shocks, tubular control arms, Wilwood brakes, & manual or power steering rack. For more information and pricing, please call 800-841-8188



## COMPLETE BASE KIT

Description	Part#
Model A Car	BX-101

## SPINDLE OPTION

Description	Part#
Plain Spindles	BS-007
Polished Stainless Steel Spindles For 12" & 13" Brake Kits	BS-012
Polished Stainless Spindles W/ Stainless Steel Brackets For 11" Kits	BS-012-S

## FRONT SHOCK & SPRING OPTIONS

Description	Part#
Single Adjustable Billet Coil-Over Shocks (400#, 450#, 500#, 550#)	BS-001-XXX
Double Adjustable Billet Coil-Over Shocks (400#, 450#, 500#, 550#)	BS-001-D-XXX
Polished Billet Coil-Over Shocks (400#, 450#, 500#, 550#)	BS-002-XXX

## 4 LINK OPTIONS

Description	Part#
Model A Plain (Triangulated)	RB-201
Model A Plan (Triangulated) Stainless Steel	RB-201-SS
Model A Plain (Parallel 4 Link)	RB-101
Model A Polished Stainless Steel (Parallel 4 Link)	RB-101-SS

## HOUSINGS, AXLES

Description	Part #
Housing, 9", T.W.	RC-040-XX
Axles, 31 Spline, T.W.	RC-041-XX-31
3RD Member, Iron Open (choose gearing)	BN-350-I
3RD Member, Iron Posi (choose gearing)	BN-350-I-L

## COILOVER CROSSMEMBER, HARDWARE KIT

Description	Part #
32-40 Ford - Plain	HK-049
32-40 Ford - Polished Stainless Steel	HK-049-P
RB-052	RB-052

## BRAKE OPTIONS

Description	Part #
Iron 11" Rotor with Wilwood 4 Piston Polish Caliper (Chevy, Ford BP)	BS-008-K
Wilwood 11" Drilled Rotor with 4 Piston Caliper (choose color)	BSS-020-D
Wilwood 12" Drilled Rotors, 4 Piston Calipers (choose color)	DF-209
Wilwood 13" Drilled Rotors, 6 Piston Calipers (choose color)	DFS-207

## RACK & PINION

Description	Part #
Manual Rack & Pinion	BS-004
Manual Rack & Pinion, With SS Tie Rod Ends	BS-004-SS
New Power Rack & Pinion	BS-004-NPS
New Power Rack & Pinion, With SS Tie Rod Ends	BS-004-NPS-SS
Manual Rack & Pinion, billet	BS-004-B
Manual Rack & Pinion, Billet, With SS Tie Rod Ends	BS-004-B-SS

## REAR SHOCKS & SPRINGS

Description	Part #
Plain Billet Coil-Over Shocks (250#, 300#, 350#)	CB-105
Black Coil-Over Shocks (250#, 300#, 350#)	CO-101

## PANHARD BAR OPTIONS

Description	Part #
'32 Ford Plain Panhard Bar	RP-112
'32 Ford Stainless Steel Panhard Bar	RP-112-S

## SWAYBAR OPTIONS

Description	Part #
Sway Bar	BS-055
Chrome Sway Bar	BS-055-C





**OUR KITS ARE PRE-FITTED, READY TO INSTALL!  
NO MISTAKES, EVERYTHING'S PRE-CUT.**



**MUSTANG II  
CROSSMEMBERS**



- One-Piece Shock Cups are T.I.G welded in place. First class, for your car.
- Built-in Anti-Dive is all fitted to your frame... No Grinding Required! Nothing to measure or trim...It's All Done!
- Vertical Inner Uprights. This is the strongest design available, with twice the weld area. This will keep your frame from twisting!
- Main Crossmember made from only 2 Formed Pieces for maximum strength and Accurate Fit. This is VERY important!
- Crossmember and Spring Towers pre-cut and pre-welded to fit your frame... Nothing to Measure!



KX-101

**UNIVERSAL MUSTANG II CROSSMEMBERS**

**UNIVERSAL MUSTANG II CROSSMEMBERS FOR 56 1/2" OR 60" TRACK WIDTH VEHICLES**

This kit fits larger vehicles that have a 60" track width. It is intended for use with our 4" Rack Extension Kit to keep the geometry straight.

56 1/2" track width crossmembers fit frame rail from 24" to 30"  
60" track width crossmembers fit frame rail from 27 1/2" to 33 1/2" (Inside to inside frame dimensions)

Description	Part#
56-1/2" Track Width Crossmember	KX-101-E
60" Track Width Crossmember *Rack Extension Kit Required	KX-102-E
56-1/2" Track Width Crossmember for Full A-Frame Lower	KX-101-E-K
60" Track Width Crossmember for Full A-Frame Lower	KX-102-E-K

**SUBFRAME / CROSSMEMBER ASSEMBLY - ONLY**

Description	Part#
Subframe/Crossmember Assembly	CX-320-S
Crossmember Only	CX-320-E



# THE FORD GEOMETRY IS ALREADY BUILT IN. NOTHING TO CUT, JUST WELD IN PLACE!

## FORD IFS

Our Mustang IFS kits for Fords are natural conversions for the Ford frames. We retain all the factory dimensions and locations, so you get all the benefit of Ford engineering in your front end. There's absolutely no reason to widen or otherwise modify the Ford design or use long tie rod ends!

These kits fit the frames easily and yield a 3"-4" suspension drop.

Included in most kits are all the special, hard-to-make brackets and mounts you will need to complete the installation, plus HEIDTS® own illustrated installation booklet.

We don't make a Mustang conversion kit for the Model A or '32 Ford. See our Superide IFS kits for these cars. These cars, because of their direct mounting low fenders, require modifying the Ford IFS design by relocating the upper control arm inner pivot to clear the fender, causing a very noticeable amount of bumpsteer! Turn to the Tech info on page 75 for more detailed information on this subject.

## UNIVERSAL MUSTANG II CROSSMEMBERS

Put a HEIDTS® Mustang II crossmember in your car! Using our Multi-fit Mustang II Crossmember Kit you can now adapt the very popular Mustang II suspension with HEIDTS® correct geometry into almost any application. The crossmember and spring towers are made oversized to allow trimming and fitting to your particular frame size. Templates and instructions, designed for a home builder to install, walk you through the entire installation to insure that you get correct anti-dive and geometry.

## CHEVY IFS

The Chevy models shown here also have frames and fenders which lend themselves nicely to Mustang front end conversion, without changing the critical geometry. Chevy IFS kits also come complete with the hard-to-make special brackets, such as radiator perch on certain models, to quickly and easily complete the installation. And naturally, like our Ford kits, Chevy kits do not bumpsteer at all. See our Tech info on page 75 of this catalog for a more detailed explanation of the hazards of bumpsteer

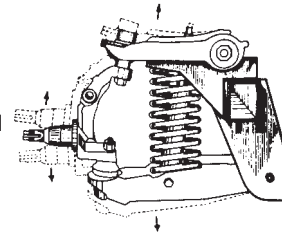
## OUR IFS KITS RETAIN ALL THE ORIGINAL SUSPENSION FEATURES!

- Longer tie rod ends aren't used – ever!
- Mounting points of all control arms match the original ford design.
- Factory anti-dive built right in.

Chevy kits also come with a step-by-step, fully-illustrated instruction booklet to ensure that your installation goes as easily as it should!

## INSTALLATION BOOKLET

Included in most kits are all the special, hard-to-make brackets and mounts you will need to complete the installation, and all have a step-by-step illustrated installation booklet.



Correct design results in correct camber action – and no bumpsteer



'33-'34 Ford Car  
PX-101-E

- Upper fender adapter brackets included!  
Radiator tabs included!

- Manual Steering & Tube Arms Only



'35-'40 Ford Car

'35-'41 Ford Pick-Up  
PX-102-E

- Boxing Plates Included

- Narrowed Arms Recommended



'41-'48 Ford Car  
PX-103-E

'48-'52 Ford F-1  
Rack Extension Required  
PX-104-E

'53-'64 Ford F-100  
Rack Extension Required  
PX-105-E

- MP-037-1-4  
Manual Rack Extension
- MP-039-4  
Power Rack Extension



'34-'35 Chevy Standard Car  
CX-101-E

'34-'36 Chevy Master Car  
CX-111-E Cars Only!

- Radiator Mount included.
- Manual Steering & Tube Arms Only



'37-'39 Chevy Car  
CX-102-E

'40-'48 Chevy Car  
CX-103-E

'49-'54 Chevy Car  
CX-104-E



'37-'39 Chevy Pick-Up  
CX-305-E

'40-'46 Chevy Pick-Up  
CX-306-E

'47-'54 Chevy Pick-Up  
CX-307-E

'55-'59 Chevy Pick-Up\*  
Rack Extension Required  
CX-308-E

- Trucks Only!
- C-notched Plates included.

Strut Plates and Gussets for stock control arms available separately (Specify Application)

MP-003



**Air Ride Available For Most Applications  
Call For Details.**

# HEIDTS® MUSTANG II



Product is painted for catalog purposes only!

## INCLUDED IN BASE KIT:

- HEIDTS® Crossmember • Stock Height Spindles • Tubular Upper & Lower Arms
- 11" Rotors with Single Piston Calipers
- Stock Shocks and Springs

Now Available!  
Double Adjustable  
Shocks

## COMPLETE BASE KIT

## COMPLETE BASE KIT \$1,750

Description	Part#		
34-35 Chevy	CX-101-E-K	Multi-Fit 56" Track Width	KX-101-E-K
37-39 Chevy Car	CX-102-E-K	Multi-Fit 60" Track Width****	KX-102-E-K
40-48 Chevy Car	CX-103-E-K	33-34 Ford Car	PX-101-E-K
49-54 Chevy Car	CX-104-E-K	35-40 Ford Car/35-41	
34-36 Chevy Master	CX-111-E-K	Ford Pick-Up <<<	PX-102-E-K
37-39 Chevy Pick-Up	CX-305-E-K	41-48 Ford Car	PX-103-E-K
40-46 Chevy Pick-Up	CX-306-E-K	48-52 Ford Truck**	PX-104-E-K
47-54 Chevy Pick-Up	CX-307-E-K	53-56 Ford F100****	PX-105-E-K
55-59 Chevy Pick-Up****	CX-308-E-K		

\*\*\*\*Rack Extension Required, ### Tube Arms & Manual Rack Only, <<< Narrowed Arms Recommended

## CONTROL ARM OPTIONS

Description	Part#	
Tubular Arms (Narrowed available)	CA-112	Included
Stainless Steel Tubular Arms (Narrowed available)	CA-112-SS	Upgrade

## BRAKE OPTIONS

Description	Part#	
11" Iron Rotors & GM Calipers	DF-201-B-G or F-G	Included
12" Wilwood Drilled Rotors & 4 Piston Polished Calipers	DFM-208-P	Upgrade
13" Wilwood Drilled Rotors & 6 Piston Polished Calipers	DFM-206-P	Upgrade

Additional options available. Call for pricing.

## SPINDLE OPTIONS

Description	Part#	
Stock Spindles	MP-028	Included
2" Dropped Spindles	SP-101-K	Included

## RACK & PINION OPTIONS

Description	Part#	
Manual Rack & Pinion	MP-018-K	Included
Power Rack & Pinion	MP-038-3-K	Upgrade
Power Rack W/ Stainless Steel Tie Rod Ends	MP-038-SS-K	Upgrade

## SHOCK & SPRING OPTIONS

Description	Part#	
275# - 375# Springs & Stock Shocks	MP-007-XXX-K	Included
Single Adjustable Billet Coil-Over Shock 275# - 375#	MP-050-XXX-K	Upgrade
Double Adjustable Billet Coil-Over Shock 275# - 375#	MP-050-XXX-D	Upgrade
Thrust Bearings For Coil-Over Shocks	CQ-010	Upgrade
Spanner Wrench	TA-001	Upgrade

## ADDITIONAL OPTIONS

Description	Part#	
Polished Stainless Steel Ball Joint Caps, Pair	MP-035	Upgrade
Polished Stainless Steel Ball Joint Caps, TALL, Pair	MP-034	Upgrade
Polished Stainless Steel Tie Rod Ends, Pair	MP-017-SS	Upgrade
Aluminum Caliper Covers, Pair	DF-056	Upgrade

CX-101-E-K



CA-112-SS

MP-050



DF-201-F-G



DF-208



DF-206

MP-038-3-K



TA-001

MP-035

MP-017-SS

SP-101-K





# OPTIONS

## HEIDTS® MUSTANG II

Owner: Scott Diedrich,  
Builder: Custom Classics  
Island Lake, Illinois



### DELUXE SUSPENSION PACKAGE WITHOUT CROSSMEMBER

All packages include tubular upper & lower control arms, 11" five lug rotors, bearings, seals, springs, shocks, stock spindles, GM calipers with brackets and pads, manual rack with tie rod ends and bushings, rubber spring cushions, spindle nut kit, and all mounting hardware.

Description	Part#
Plain Tubular Arms	MP-101-B1
Plain Tubular Arms For Coil-Overs	MP-101-B2
Narrowed Plain Tubular Arms	MP-101-B3
Narrowed Plain Tubular Arms For Coil-Overs	MP-101-B4
Stainless Steel Tubular Arms	MP-101-B5
Stainless Steel Tubular Arms For Coil-Overs	MP-101-B6
Narrowed Stainless Steel Tubular Arms	MP-101-B7
Narrowed Stainless Steel Tubular Arms For Coil-Overs	MP-101-B8



## MUSTANG II

11" Billet Brake Kit includes Wilwood 4 Piston Calipers and Plain or Crossdrilled & Slotted Rotors. 12" Big Brake Kit with Wilwood 4 Piston Calipers, Polished Aluminum Hubs with Crossdrilled & Slotted Rotors.

### 11" & 12" 4 PISTON MUSTANG II BRAKES

Description	Part#
11" Wilwood Smooth Rotors & 4 Piston Black Calipers	DFM-202-B
11" Wilwood Smooth Rotors & 4 Piston Polished Calipers	DFM-202-P
11" Wilwood Smooth Rotors & 4 Piston Red Calipers	DFM-202-RED
11" Wilwood Drilled Rotors & 4 Piston Black Calipers	DFM-202-D-B
11" Wilwood Drilled Rotors & 4 Piston Polished Calipers	DFM-202-D-P
11" Wilwood Drilled Rotors & 4 Piston Red Calipers	DFM-202-D-RED
12" Wilwood Drilled Rotors & 4 Piston Black Calipers	DFM-208-B
12" Wilwood Drilled Rotors & 4 Piston Polished Calipers	DFM-208-P
12" Wilwood Drilled Rotors & 4 Piston Red Calipers	DFM-208-RED



### MUSTANG II 2" DROPPED STEEL SPINDLES

Description	Part#
Stock Spindles	MP-028
2" Dropped Spindles	SP-101-K



### TUBULAR STRUT ROD KIT

HEIDTS® offers a universal kit for factory style lower arms. You only have to notch the strut mount plates to meet your frame rail. Kit comes complete with bushings and mounting hardware.

Description	Part#
Plain Tubular Strut Rod Kit	SR-101
Polished Stainless Steel Tubular Strut Rod Kit	SR-101-SS
44 Degree Tubular Replacement Rod Kit (Pinto)	SR-020
52 Degree Tubular Replacement Rod Kit (Mustang II)	SR-021



# HEIDTS® MUSTANG II

Upper  
A-Arms (Pair)



CA-101-SS

## TUBULAR UPPER A-ARMS

Tubular Upper A-Arms are the ultimate in looks. Direct replacement for stock upper-A-arms, providing more clearance for stock sheet metal. All welds are TIG welded for maximum strength and appearance. Fits **HEIDTS®** and most other IFS kits. Arms arrive fully assembled, ready to install, including ball joints, bushings and cross shafts.

Description	Part#
Plain Tubular A-Arms	CA-101
Polished Stainless Steel Tubular A-Arms	CA-101-SS



CA-103-SS-N-S

## NARROWED UPPER & LOWER ARMS

Narrowed Upper and Lower Full A-Arms. More tire to fender clearance for deep offset wheels, as they are narrowed 5/8" per side. Must be used in sets of uppers and lowers.

Description	Part#
Narrowed Plain Upper A-Arms	CA-101-N
Narrowed Polished Stainless Steel Upper A-Arms	CA-101-SS-N
Narrowed Plain Lower A-Arms With Swaybar Mounts	CA-103-N-S
Narrowed Polished Stainless Steel Lower A-Arms With Swaybar Mounts	CA-103-SS-N-S
Narrowed Plain Lower Coil-Over A-Arms With Swaybar Mounts	CA-103-N-M-S
Narrowed Polished Stainless Steel Lower Coil-Over A-Arms With Swaybar Mounts	CA-103-SS-N-M-S

CA-102-SS



## TUBULAR LOWER CONTROL ARMS

These Tubular Lower Control Arms are direct replacement for factory lower control arms. Uses stock Mustang II, springs and strut rods. Arms arrive fully assembled ready to install, with lower shock bolts and nuts. Ball joints and bushings installed. All TIG welded for maximum strength and appearance. Fits all **HEIDTS®** Mustang II IFS kits as well as most other after market Mustang II kits.

Description	Part#
Plain Arms	CA-102
Polished Stainless Steel Arms	CA-102-SS



CA-240

## MUSTANG II REPLACEMENT PARTS

Description	Part#
Bushing Assembly, Upper	CA-240
Bushing Assembly, Lower	CA-241
Heidts Mustang II Tubular Control Arm Ball Joint Boots	CA-029
Heidts Superide / Superide II Control Arm Replacement Urethane Bushings	BX-017



Lower  
A-Arms (Pair)

CA-103-SS-S

## TUBULAR LOWER A-ARMS

Full A-Arm Lower Control Arm uses no strut rod! Triangulated A-Arm design, similar to factory G.M. control arms, provides stability and strength within the arm itself. All welds are TIG welded for ultimate strength and appearance. Comes complete, ready to install with mounting bolts, spacers, shock bolts, nuts, installed ball joints and bushings.

Description	Part#
Plain Tubular A-Arms With Swaybar Mounts	CA-103-S
Polished Stainless Steel Tubular A-Arms With Swaybar Mounts	CA-103-SS-S



# HEIDTS® MUSTANG II

## COIL-OVER LOWER ARMS

Now available – Lower Tubular Control Arms designed exclusively for coil-overs. These arms will accept any standard aftermarket coil-over shock. Available in steel or polished stainless steel for the ultimate in appearance.

Description	Part#
Plain Coil-Over Arms With Swaybar Mounts	CA-103-M-S
Polished Stainless Steel Coil-Over Arms With Swaybar Mounts	CA-103-SS-M-S
Plain Coil-Over A-Arms	CA-102-M
Polished Stainless Steel Coil-Over A-Arms	CA-102-SS-M



## STABILIZER BARS

Description	Part#
<b>Front</b>	
35-40 Ford*	SB-001
37-39 Chevy	SB-003
40-48 Chevy	SB-004
49-54 Chevy	SB-005
47-54 Chevy Pick-Up	SB-054
41-48 Ford	SB-006
48-54 Ford Pick-Up & 53-56 Ford F100	SB-007
<b>Rear</b>	
35-40 Ford (Twin Leaf)	SB-002
Universal Rear	SB-009



\*SB-001 fits '33-'34 Ford with relocation of mounting holes in frame.  
 Note: These bars can fit numerous applications with modifications to mounts.

## HEIDTS® SUPERIDE BILLET MUSTANG II COIL-OVERS

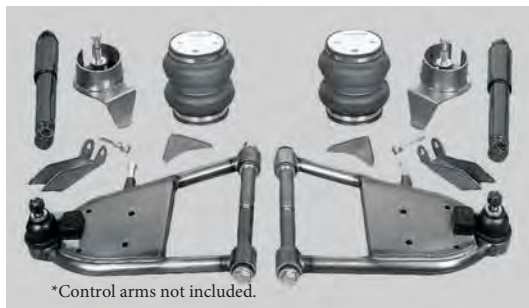
Description	Part#
Mustang II Single Adjustable Coil-Over Shocks Pr.	MP-050
Mustang II Double Adjustable Coil-Over Shocks Pr.	MP-050-D
Mustang II Single Adjustable Coil-Over Shocks Pr. Polished	MP-050-P
375# Silver Powder Coated Coil Springs, Pair	MP-041
500# Silver Powder Coated Coil Springs, Pair	MP-042
600# Silver Powder Coated Coil Springs, Pair	MP-043
700# Silver Powder Coated Coil Springs, Pair	MP-044



## HEIDTS® AIR SHOCK SUSPENSION SYSTEM

Now add air ride comfort and the ultimate in coolness to your muscle car or street rod with **HEIDTS®** Air Shock Suspension System. You can cruise in the smoothest ride around to your rod run, and with just a touch of a button drop your street rod 2"-3". When it is time to go home, just pump up the suspension and float on home. **HEIDTS®** Air Shock Suspension System does it all. Kit includes shocks, upper shock mounts, upper air spring adapters, and air springs.

Description	Part#
HEIDTS® Air Shock Upgrade Kit	AS-110



\*Control arms not included.



# HEIDTS SUPERIDE®



Product is painted for catalog purposes only! All kits ship with Silver Powder Coated Springs - not shown.

## COMPLETE BASE KIT

### INCLUDED IN BASE KIT:

- HEIDTS® Crossmember
- Superide Spindles
- Tubular Upper & Lower Arms, Standard or Narrowed
- 11" Rotors with 4 Piston Wilwood Calipers
- Manual Rack & Pinion Steering
- Billet Single Adjustable Coil-Over Shocks with Silver Powder Coated Springs

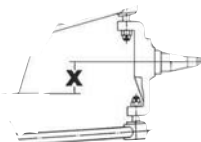
Now Available!  
Double Adjustable  
Shocks



## ALL NEW SUPERIDE-NOT A MUSTANG CONVERSION KIT!

Because this Independent Front Suspension was designed as a complete system, the individual components are not interchangeable with any other stock pieces. Every piece was designed specifically by HEIDTS® for the SUPERIDE systems. It's your assurance of the right geometry, the right fit, and of course — a super ride!

Final ride height from spindle to bottom of frame: '28-'35 Chevy = 1-1/2"  
'32 Ford = 2-1/2", '33-'34 & "A" Ford = 2"



## HEIDTS® IFS IS BETTER

Independent Front Suspension gives you twice the ride of a new 4-link dropped axle at a comparable cost. It adds more cash value to your car than any other type of suspension. With HEIDTS® engineering you get an unmatched, correct, safe ride. HEIDTS® SUPERIDE complete system is perfect for the ultimate stance! Shipped by UPS, our SUPERIDE arrives complete hub to hub with no other parts to buy.

## SMOOTH SAILING

"Smooth" describes the ride: very low and highly steerable with no bumpsteer and built-in anti-dive. Installing the one piece crossmember is an easy one-step operation. The upper control arms are designed to clear the fenders. The 56" hub to hub tread width gives you the narrow look without any tire to fender clearance problems.

## HEIDTS® EXCLUSIVE SUPERIDE SPINDLE

This is not a Mustang dropped spindle. HEIDTS® has designed its own one piece spindle specifically for the SUPERIDE. So, now you can get the lowest ride available that's tops in looks and safety! It's clean and trim adding to the high tech appearance you want for your front end. For peace of mind we've made it out of 1045 heat treated alloy steel.

## COMPLETE BASE KIT

Description	Part#
27-31 Model A Ford	BX-101
32 Ford	BX-102
33-34 Ford	BX-103
28-35 Chevy - Use W/ Narrowed Control Arms	BX-114

# OPTIONS

## HEIDTS SUPERIDE®

Owner: Claire Ball  
Falcon Hot Rods



### CONTROL ARM OPTIONS

Description	Part#	
Tubular Arms (Narrowed available)	BS-005	Included
Stainless Steel Tubular Arms (Narrowed available)	BS-006	Upgrade

### BRAKE OPTIONS

Description	Part#	
11" Iron Rotors, Wilwood 4 Piston Polished Calipers, Chevy Bolt Pattern	BS-008-K	Included
11" Iron Rotors, Wilwood 4 Piston Red Calipers, Chevy Bolt Pattern	BS-008-K-R	Included
11" Iron Rotors, Wilwood 4 Piston Black Calipers, Chevy Bolt Pattern	BS-008-K-B	Included
11" Iron Rotors, Wilwood 4 Piston Polished Calipers, Ford Bolt Pattern	BS-009-K	Included
11" Iron Rotors, Wilwood 4 Piston Red Calipers, Ford Bolt Pattern	BS-009-K-R	Included
11" Iron Rotors, Wilwood 4 Piston Black Calipers, Ford Bolt Pattern	BS-009-K-B	Included
11" Iron Rotors, GM Calipers, 5" Bolt Pattern	BS-009-5-K	Upgrade
11" Wilwood Smooth Rotors & 4 Piston Polished Calipers W/ Polished Hubs	BSS-020	Upgrade
11" Wilwood Drilled Rotors & 4 Piston Polished Calipers W/ Polished Hubs	BSS-020-D	Upgrade
12" Wilwood Drilled Rotors & 4 Piston Polished Calipers W/ Polished Hubs**	DFS-209	Upgrade
13" Wilwood Drilled Rotors & 6 Piston Black Calipers W/ Black Hubs**	DFS-207-B	Upgrade
13" Wilwood Drilled Rotors & 6 Piston Polished Calipers W/ Black Hubs**	DFS-207-P	Upgrade

\*\*12" or 13" Optional Brake Packages Require Optional Stainless Steel Spindles

### SPINDLE OPTIONS

Description	Part#	
Superide Chromoly Alloy Steel Spindles	BS-007	Included
Polished Stainless Steel Spindles For 12" & 13" Brake Kits	BS-012	Upgrade
Polished Stainless Steel Spindles W/Aluminum Brackets For 11" Brake Kits	BS-0125-S	Upgrade

### RACK & PINION OPTIONS

Description	Part#	
Manual Rack & Pinion	BS-004	Included
Manual Rack & Pinion W / Stainless Steel Tie Rod Ends	BS-004-SS	Upgrade
Billet Manual Rack & Pinion	BS-004-B-K	Upgrade
Power Rack & Pinion	BS-004-NPS	Upgrade

### SHOCK & SPRING OPTIONS

Description	Part#	
Single Adjustable Billet Coil-Over Shocks 400#, 450#, 500#, 550#	BS-001-XX	Included
Double Adjustable Billet Coil-Over Shocks#, 500#, 550#	BS-001-XX	Upgrade
Polished Single Adjustable Billet Coil-Over Shocks	BS-002-XX	Upgrade
Thrust Bearings For Coil-Over Shocks	CQ-010	Upgrade
Spanner Wrench	TA-001	Upgrade

### ADDITIONAL OPTIONS

Description	Part#	
Power Steering Valve	PS-101	Upgrade
11" Polished Rotor Covers for Stainless Steel Spindles		
- Must Use BS-012 Spindles, Pair	BS-010	Upgrade
12" Polished Rotor Covers for Stainless Steel Spindles		
- Must Use BS-012 Spindles, Pair	BS-018	Upgrade
Swaybar	BS-055	Upgrade
Chrome Swaybar	BS-055-C	Upgrade
Polished Caliper Covers, Pair	DF-056	Upgrade
14" Braided Stainless Steel Brake Line Kit	BX-055	Upgrade
Polished Stainless Steel Ball Joint Caps, Pair	BS-029	Upgrade
Power Steering Hose Kit for Superide Integral Reservoir	PS-116	Upgrade
Power Steering Hose Kit for Superide Remote Reservoir	PS-117	Upgrade



# HEIDTS SUPERIDE® OPEN WHEEL

## HEIDTS SUPERIDE® OPEN WHEEL



BX-105

Product is painted for catalog purposes only! All kits ship with Silver Powder Coated Springs - not shown.

## HEIDTS SUPERIDE® INBOARD SHOCK



BX-105-IN

Product is painted for catalog purposes only! All kits ship with Silver Powder Coated Springs - not shown.

### HEIDTS® IFS IS BETTER

Our HEIDTS SUPERIDE® Open Wheel is designed for fenderless cars with pinched rails. The swept back style control arms, with the front tubes in line with the axle center are longer to meet up closer to the frame rails. The kit is designed for rails pinched to approximately 20" wide at axle center line, which is what a '32 Ford grill shell is. Ride height will be 1.25" lower than regular Superide to have that nice lowrider look so popular with fenderless cars. Control arms are available in mild steel and polished stainless steel. Shocks are available in plain or polished. Springs are chrome on all models. All kits come with Wilwood polished aluminum 4-piston calipers. Also available is our polished aluminum hub option, the finishing touch for a front suspension of this caliber. Hub to hub track width is 56" flange to flange. Both Ford and Chevy bolt patterns are available in both outboard and inboard shock configurations.

These kits are designed for the experienced home builder or shop installation, as frame modifications are required. Rails must be pinched in and c-notching of the rails for the rack boots is required. A radiator with custom lower tank will also be required.

### COMPLETE BASE KIT

#### INCLUDED IN BASE KIT:

- HEIDTS® Crossmember • Superide Spindles • Tubular Upper & Lower Arms, Standard or Narrowed
- Manual Rack & Pinion Steering • 11" Rotors with 4 Piston Wilwood Calipers • Billet Single Adjustable Coil-Over Shocks with Silver Powder Coated Springs

Now Available!  
Double Adjustable Shocks

### HEIDTS® EXCLUSIVE SUPERIDE DROPPED SPINDLE

This is not a Mustang dropped spindle. HEIDTS® has designed its own one piece spindle specifically for the HEIDTS SUPERIDE®. So, now you can get the lowest ride available that's tops in looks and safety! It's clean and trim adding to the high tech appearance you want for your front end. For peace of mind we've made it out of 1045 heat treated alloy steel. Also available is our New HEIDTS® Stainless Steel Spindle for the ultimate finishing touch.

#### COMPLETE BASE KIT

Description	Part#
32 Ford Pinched Rails	BX-105
32 Ford Pinched Rails & Inboard Shocks	BX-105-IN
32 Ford Pinched Rails & Inboard Shocks With SS Push Rods	BX-105-IN-SS



# OPTIONS

## HEIDTS SUPERIDE® OPEN WHEEL



Owner: Pete Schmid  
Builder: Louvers Unlimited

### CONTROL ARM OPTIONS

Description	Part#	
Tubular Arms	BS-030	Included
Stainless Steel Tubular Arms	BS-031	Upgrade

### BRAKE OPTIONS

Description	Part#	
11" Iron Rotors, Wilwood 4 Piston Polished Calipers, Chevy Bolt Pattern	BS-008-K	Included
11" Iron Rotors, Wilwood 4 Piston Red Calipers, Chevy Bolt Pattern	BS-008-K-R	Included
11" Iron Rotors, Wilwood 4 Piston Black Calipers, Chevy Bolt Pattern	BS-008-K-B	Included
11" Iron Rotors, Wilwood 4 Piston Polished Calipers, Ford Bolt Pattern	BS-009-K	Included
11" Iron Rotors, Wilwood 4 Piston Red Calipers, Ford Bolt Pattern	BS-009-K-R	Included
11" Iron Rotors, Wilwood 4 Piston Black Calipers, Ford Bolt Pattern	BS-009-K-B	Included
11" Iron Rotors, GM Calipers, 5" Bolt Pattern	BS-009-5-K	Upgrade
11" Wilwood Smooth Rotors & 4 Piston Polished Calipers W/ Polished Hubs	BSS-020	Upgrade
11" Wilwood Drilled Rotors & 4 Piston Polished Calipers W/ Polished Hubs	BSS-020-D	Upgrade
12" Wilwood Drilled Rotors & 4 Piston Polished Calipers W/ Polished Hubs**	DFS-209	Upgrade
13" Wilwood Drilled Rotors & 6 Piston Black Calipers W/ Black Hubs**	DFS-207-B	Upgrade
13" Wilwood Drilled Rotors & 6 Piston Polished Calipers W/ Black Hubs**	DFS-207-P	Upgrade

\*\*12" or 13" Optional Brake Packages Require Optional Stainless Steel Spindles



### SHOCK & SPRING OPTIONS

Description	Part#	
Single Adjustable Billet Coil-Over Shocks 350#,400,450,500,550,600	BS-027-XX	Included
Double Adjustable Billet Coil-Over Shocks 350#,400,450,500,550,600	BS-027-D-XX	Upgrade
Polished Single Adj. Coil-Over Shocks 350#,400,450,500,550,600	BS-028-XX	Upgrade
Polished Double Adj. Coil-Over Shocks 350#,400,450,500,550,600	BS-028-D-XX	Upgrade
Thrust Bearings For Coil-Over Shocks	CQ-010	Upgrade
Spanner Wrench	TA-001	Upgrade



BS-020



BS-020-D

### SPINDLE OPTIONS

Description	Part#	
Plain Spindles	BS-007	Included
Polished Stainless Steel Spindles For 12" & 13" Brake Kits	BS-012	Upgrade
Pol. Stainless Steel Spindles W/Aluminum Brackets For 11" Brake Kits	BS-012-S	Upgrade



DF-209-P



BS-010, BS-018

### RACK & PINION OPTIONS

Description	Part#	
Manual Rack & Pinion	BS-004	Included
Manual Rack & Pinion W/Stainless Steel Tie Rod Ends	BS-004-SS	Upgrade
Billet Manual Rack & Pinion	BS-004-B	Upgrade
Billet Manual Rack & Pinion W/Stainless Steel Tie Rod Ends	BS-004-B-SS	Upgrade



BS-004-B

### ADDITIONAL OPTIONS

Description	Part#	
11" Polished Rotor Covers for Stainless Steel Spindles		
- Must Use BS-012 Spindles	BS-010	Upgrade
12" Polished Rotor Covers for Stainless Steel Spindles		
- Must Use BS-012 Spindles	BS-018	Upgrade
Polished Stainless Steel Tie Rod Ends, Pair	MP-017-SS	Upgrade
Swaybar	BS-053	Upgrade
Chrome Swaybar	BS-053-C	Upgrade
Aluminum Caliper Covers, Pair	DF-056	Upgrade
16" Braided Stainless Steel Brake Line Kit	BX-055-1	Upgrade
Polished Stainless Steel Ball Joint Caps, Pair	BS-029	Upgrade



BS-029



MP-017-SS

# HEIDTS SUPERIDE® II

HEIDTS® STREET ROD PARTS



Product is painted for catalog purposes only! All kits ship with Silver Powder Coated Springs - not shown.

### INCLUDED IN BASE KIT:

- HEIDTS® Crossmember
- Tubular Upper & Lower Arms, Standard or Narrowed
- Stock Mustang II Spindles
- Manual Rack & Pinion Steering
- 11" Rotors with 4 Piston Wilwood Calipers
- Billet Single Adjustable Coil-Over Shocks with Silver Powder Coated Springs

Now Available!  
Double Adjustable  
Shocks

### COMPLETE BASE KIT

#### HEIDTS® IFS IS BETTER

Our HEIDTS SUPERIDE® II IFS System is the ultimate front suspension system for fat fendered Ford fans, '35-'40 Ford and '41-48 Fords. Enjoy driving your fat fendered cruiser with the smooth ride and good handling of independent suspension. Add to the value of your car with a HEIDTS® independent suspension system, the most popular suspension system in use today. Why? Because they are engineered right to work right.



#### ALL NEW! NOT A MUSTANG CONVERSION KIT!

Our HEIDTS SUPERIDE® II IFS System uses a Mustang II spindle to allow for a front mount rack & pinion unit, this allows for easy engine installation. The upper control arms use threaded adjusters for the wheel alignment. These threaded adjusters, unlike eccentric adjusters, will never "slip" and lose alignment no matter how big a bump you hit. "Smooth" describes the ride: very low and highly steerable with no bumpsteer and built-in anti-dive. Installing the 3-piece cross member is an easy operation. Combined with detailed instructions your installation will be as smooth as your ride with your new HEIDTS SUPERIDE® II from HEIDTS®.

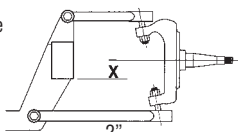


BX-202 '35-'40 Ford Car BX-202 '35-'41 Ford Pick-up BX-203 '41-'48 Ford BX-212 '37-'39 Chevy



BX-213 '40-'48 Chevy BX-305 '40-'46 Chevy Pick-up BX-306 '47-'54 Chevy Pick-up BX-211 '37-'41 Willy's

Final ride height from spindle to bottom of frame:



- '35-'48 Ford 2"
- '37-'41 Willy's 2"
- '37-'48 Chevy 2"
- '40-'46 Chevy Pick-up 2-13/16"
- '47-'54 Chevy Pick-up 2-13/16"

\* (Stock spindles may be substituted to raise vehicle 2".)

#### COMPLETE BASE KIT

Description	Part#
35-40 Ford + 35-41 Ford Pick-Up	BX-202
41-48 Ford	BX-203
37-41 Willys	BX-211
37-41 Willys IDA or Outlaw Chassis	BX-211-N
37-39 Chevy	BX-212
40-48 Chevy	BX-213
40-46 Chevy Pick-Up	BX-305
47-54 Chevy Pick-Up	BX-306

Order/Tech: 800-841-8188



# OPTIONS

## HEIDTS SUPERIDE® II

Owner: Lonnie & Sharon Keith  
 Builder: Street Rods by Michael



### CONTROL ARM OPTIONS

Description	Part#	
Tubular Arms	BS-025	Included
Stainless Steel Tubular Arms	BS-026	Upgrade

### BRAKE OPTIONS

Description	Part#	
11" Iron Rotors & 4 Piston Black or Polished Calipers	DF-202-C-B or C-P	Included
12" Wilwood Drilled Rotors & 4 Piston Black, Polished Calipers	DFS-208	Upgrade
13" Wilwood Drilled Rotors & 6 Piston Black, Polished Calipers	DFS-206	Upgrade

Additional options available. Call for pricing.

### SPINDLE OPTIONS

Description	Part#	
Stock Spindles	MP-028	Included
2" Dropped Spindles	SP-101-K	Included

### RACK & PINION OPTIONS

Description	Part#	
Manual Rack & Pinion	MP-018-I-K	Included
Power Rack & Pinion	MP-038-3-K	Upgrade
Power Rack W/ Stainless Steel Tie Rod Ends	MP-038-SS-K	Upgrade

### SHOCK & SPRING OPTIONS

Description	Part#	
Single Adjustable Billet Coil-Over Shocks 400#, 450#, 500#, 550#	BS-001-XX	Included
Double Adjustable Billet Coil-Over Shocks 400#, 450#, 500#, 550#	BS-001-D	Upgrade
Polished Billet Single Adj. Coil-Over Shocks 400#, 450#, 500#, 550#	BS-002-XX	Upgrade
Thrust Bearings For Coil-Over Shocks	CQ-010	Upgrade
Spanner Wrench	TA-001	Upgrade

### ADDITIONAL OPTIONS

Description	Part#	
Swaybar	BS-056	Upgrade
Narrowed Swaybar	BS-056-N	Upgrade
Chrome Swaybar	BS-056-C	Upgrade
Narrowed Chrome Swaybar	BS-056-C-N	Upgrade
Polished Stainless Steel Ball Joint Caps, Pair	MP-034	Upgrade
14" Braided Stainless Steel Brake Line Kit	BX-055	Upgrade

BS-026



DF-202-P-K



DF-202-D-P-K



DF-208-P-K



DF-206-B-K



SP-101-K

MP-038-3-K



MP-035



BX-055



# CLASSIC TRUCKS

## HEIDTS SUPERIDE® II



Product is painted for catalog purposes only! All kits ship with Silver Powder Coated Springs - not shown.

**THE BEST RIDE IN TOWN FOR CLASSIC TRUCKS - AVAILABLE FOR: '55-'59 CHEVY, '53-'64 FORD**

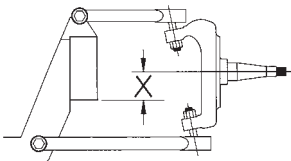
### INCLUDED IN BASE KIT:

- HEIDTS® Crossmember
- Stock or Dropped Mustang II Spindles
- Tubular Upper & Lower Arms, Standard or Narrowed
- Manual Rack & Pinion Steering
- 11" Rotors with 4 Piston Wilwood Calipers
- Billet Single Adjustable Coil-Over Shocks with Silver Powder Coated Springs

Now Available!  
Double Adjustable  
Shocks



Final ride height from spindle to bottom of frame:



'55-'59 Chevy Pick-Up 2-1/2" \*

'53-'56 Ford Pick-Up 0

\*Stock spindles may be substituted to raise vehicle 2".

### COMPLETE BASE KIT

#### HEIDTS® IFS IS BETTER

Our HEIDTS SUPERIDE® II IFS System is the ultimate front suspension system. Enjoy driving with the smooth ride and good handling of independent suspension, and add to the value of your classic truck with a HEIDTS® independent suspension system, the most popular suspension system in use today. Why? Because they are engineered right to work right!

#### ALL NEW! NOT A MUSTANG CONVERSION KIT!

Our HEIDTS SUPERIDE® II IFS System uses a Mustang II spindle to allow for a front mount rack & pinion unit, this allows for easy engine installation. The upper control arms use threaded adjusters for the wheel alignment. These threaded adjusters, unlike eccentric adjusters, will never "slip" and lose alignment no matter how big a bump you hit. "Smooth" describes the ride: very low and highly steerable with no bumpsteer and built-in anti-dive. Installing the 3-piece cross member is an easy operation. Combined with detailed instructions your installation will be as smooth as your ride with your new HEIDTS SUPERIDE® II from HEIDTS®.

#### COMPLETE BASE KIT

Description	Part#
55-59 Chevy Pick-Up	BX-307
48-52 Ford Pick-Up	BX-310
53-64 Ford Pick-Up	BX-316



BX-316 '53-'56 Ford F-100



BX-307 '55-'59 Chevy Pick-Up

# OPTIONS

## HEIDTS SUPERIDE® II

Custom Classics  
Island Lake, Illinois



### CONTROL ARM OPTIONS

Description	Part#	
Tubular Arms (Narrowed available)	BS-021-RS	Included
Stainless Steel Tubular Arms (NA)	BS-022-RS	Upgrade

### BRAKE OPTIONS

Description	Part#	
11" Iron Rotors & 4 Piston Black or Polished Calipers	DF-202-C-B or C-P	Included
12" Wilwood Drilled Rotors & 4 Piston Black, Calipers	DFS-208-B	Upgrade
13" Wilwood Drilled Rotors & 6 Piston Black, Calipers	DFS-206-B	Upgrade

Additional options available. Call for pricing.

### SPINDLE OPTIONS

Description	Part#	
Stock Spindles ( Standard on BX-316, Option on BX-307)	MP-028	Included
2" Dropped Spindles (Standard on BX-307, Option on BX-316)	SP-101-K	Included

### RACK & PINION OPTIONS

Description	Part#	
Manual Rack & Pinion	MP-018-1-K-CT	Included
Chrome Manual Rack	MP-018-C-K-CT	Upgrade
Power Rack	MP-038-3-K-CT	Upgrade
Chrome Power Rack	MP-038-C-K-CT	Upgrade

### SHOCK & SPRING OPTIONS

Description	Part#	
Single Adjustable Billet Coil-Over Shocks 400#, 450#, 500#, 550#	BS-003-XX	Included
Double Adjustable Billet Coil-Over Shocks 400#, 450#, 500#, 550#	BS-003-D	Upgrade
Thrust Bearings For Coil-Over Shocks	CQ-010	Upgrade
Spanner Wrench	TA-001	Upgrade

### ADDITIONAL OPTIONS

Description	Part#	
Swaybar	BS-054-RS	Upgrade
Chrome Swaybar	BS-054-C-RS	Upgrade
Polished Stainless Steel Ball Joint Caps, Pair	MP-035	Upgrade
14" Braided Stainless Steel Brake Line Kit	BX-055	Upgrade

BS-022-RS



BS-054-C



MP-035



BX-055

# '65-'72 FORD F-100 HEAVY DUTY FRONT SUBFRAME

## NEW! BOLT-IN FULL FRONT SUSPENSION



### 64" TRACK WIDTH



Product is painted for catalog purposes only! All kits ship with Silver Powder Coated Springs - not shown.

#### INCLUDED IN BASE KIT:

- 1-1/4" Upper Tubular Control Arms & 1-1/2" Lower Tubular Control Arms
- 11" Disc Brakes with Wilwood 4-Piston Calipers
- Choice of Stock or Dropped Mustang II Spindles
- Power Rack & Pinion
- Bolt-On 3x4 Crossmember made out of 7GA with an Internal Gusset for added strength
- Adjustable Billet Shocks and Silver Powder Coated Springs

Now Available!  
Double Adjustable  
Shocks

#### COMPLETE BASE KIT

Description	Part#
65-72 F100 Superide II 64" TW	BX-640

#### CONTROL ARM OPTIONS

Description	Part#	Included
1-1/4" Upper and 1-1/2" Lower Tubular Arm Kit	BS-081	Included

#### BRAKE OPTIONS

Description	Part#	Included
11" Iron Rotors, Wilwood 4 Piston Black Calipers, Chevy Bolt	DF-202-C-B-K	Included
11" Iron Rotors, Wilwood 4 Piston Pol. Calipers, Chevy Bolt	DF-202-C-P-K	Included
11" Iron Rotors, Wilwood 4 Piston Red Calipers, Chevy Bolt	DF-202-C-RED-K	Included
11" Iron Rotors, Wilwood 4 Piston Black Calipers, Ford Bolt	DF-202-F-B-K	Included
11" Iron Rotors, Wilwood 4 Piston Polished Calipers, Ford Bolt	DF-202-F-P-K	Included
11" Iron Rotors, Wilwood 4 Piston Red Calipers, Ford Bolt	DF-202-F-RED-K	Included
11" Wilwood Smooth Rotors & 4 Piston Black Calipers	DFS-202-B	Upgrade
11" Wilwood Smooth Rotors & 4 Piston Polished Calipers	DFS-202-P	Upgrade
11" Wilwood Smooth Rotors & 4 Piston Red Calipers	DFS-202-RED	Upgrade
11" Wilwood Drilled Rotors & 4 Piston Black Calipers	DFS-202-D-B	Upgrade
11" Wilwood Drilled Rotors & 4 Piston Polished Calipers	DFS-202-D-P	Upgrade
11" Wilwood Drilled Rotors & 4 Piston Black Calipers	DFS-202-D-RED	Upgrade
12" Wilwood Drilled Rotors & 4 Piston Black Calipers	DFS-208-B	Upgrade
12" Wilwood Drilled Rotors & 4 Piston Polished Calipers	DFS-208-P	Upgrade
12" Wilwood Drilled Rotors & 4 Piston Red Calipers	DFS-208-RED	Upgrade
13" Wilwood Drilled Rotors & 6 Piston Black Calipers	DFS-206-B	Upgrade
13" Wilwood Drilled Rotors & 6 Piston Polished Calipers	DFS-206-P	Upgrade
13" Wilwood Drilled Rotors & 6 Piston Red Calipers	DFS-206-RED	Upgrade

#### SPINDLE OPTIONS

Description	Part#	Included
Stock Spindles	MP-028	Included
2" Dropped Spindles	SP-101-K	Included

#### RACK & PINION OPTIONS

Description	Part#	Included
Power Rack & Pinion 20:1 ratio, 3 turn lock to lock	ST-002-K	Included

#### SHOCK & SPRING OPTIONS

Description	Part#	Included
Single Adjustable Billet Coil-Over Shock	CB-105-G	Included
Double Adjustable Billet Coil-Over Shock	CB-105-D-G	Upgrade
350# Silver Powder Coated 10" Spring	CSV-350-10	Included
400# Silver Powder Coated 10" Spring	CSV-400-10	Included
450# Silver Powder Coated 10" Spring	CSV-450-10	Included
500# Silver Powder Coated 10" Spring	CSV-500-10	Included
550# Silver Powder Coated 10" Spring	CSV-550-10	Included
600# Silver Powder Coated 10" Spring	CSV-600-10	Included

#### ADDITIONAL OPTIONS

Description	Part#	Included
Motor Mount Stands- Please Call For Your Application		
1" Solid Front Sway Bar with Hardware	SB-216	Upgrade
Universal Tall Transmission Cross Member	BX-657	Upgrade
Universal Transmission Cross Member	BX-652	Upgrade
Steering hook up kit for power rack to IDIDIT Column	SC-317	Upgrade
IDIDIT Paintable, Tilt, Floor shift w/ 3/4"-36 spline shaft	1120657010	Upgrade
IDIDIT Black Powder coat, Tilt, Floor shift 3/4"-36 spline shaft	1120657051	Upgrade
IDIDIT Paintable, Tilt, Floor shift w/ 3/4"-36 spline shaft	1120657020	Upgrade
IDIDIT Paintable, Tilt, Column shift w/ 3/4"-36 spline shaft	1140657010	Upgrade
IDIDIT Black Powder coat, Tilt, Column shift 3/4"-36 spline shaft	1140657051	Upgrade
IDIDIT Chrome, Tilt, Column shift w/ 3/4"-36 spline shaft	1140657020	Upgrade



Order/Tech: 800-841-8188

HEIDTS® STREET ROD PARTS



# '65-'72 FORD F-100 HEAVY DUTY REAR 4-LINK

## NEW! BOLT-IN HEAVY DUTY 4-LINK



### COMPLETE BASE KIT

Product is painted for catalog purposes only! All kits ship with Silver Powder Coated Springs - not shown.



#### COMPLETE BASE KIT

Description	Part#
66-72 F-100 Rear 4-Link with Axle Brackets	RB-113
66-72 F-100 Rear 4-Link less Axle Brackets (use if ordering our housing)	RB-113-H

#### SHOCK OPTION

Description	Part#	
Single Adjustable Billet Coil-Over Shock	CB-105-G	Included
Double Adjustable Billet Coil-Over Shock	CB-105-D-G	Upgrade

#### SPRING OPTIONS

Description	Part#	
200 lb 10" spring	CSV-200-10	Included
250 lb 10" spring	CSV-250-10	Included
300 lb 10" spring	CSV-300-10	Included
350 lb 10" spring	CSV-350-10	Included
400 lb 10" spring	CSV-400-10	Included

#### 3RD MEMBER OPTIONS

Description	Part#	
Positraction 31 Spline 3.00 Ratio	BN-300-I-L	Upgrade
Positraction 31 Spline 3.25 Ratio	BN-325-I-L	Upgrade
Positraction 31 Spline 3.50 Ratio	BN-350-I-L	Upgrade
Positraction 31 Spline 3.70 Ratio	BN-370-I-L	Upgrade
Positraction 31 Spline 3.90 Ratio	BN-390-I-L	Upgrade
Positraction 31 Spline 4.11 Ratio	BN-411-I-L	Upgrade

#### REAR AXLES 31 SPLINE

Description	Part#	
64" Track 31 Spline Axles, Pr.	RC-041-64-31	Upgrade

#### 4-LINK FEATURES:

- 64 inch track width
- Double adjustable link Tubes (1.75 inch 120 DOM)\*
- Rods Ends are 1 Inch (largest in Industry)\*
- Optional Fabricated (Star Wars) housing\*
- Adjustable ride Height\*
- Adjustable 3 position Pan Hard Bar\*
- Billet Aluminium Shock Mounts\*
- Built in Drive shaft Loop

\* Industry Exclusive

Now Available!  
Double Adjustable  
Shocks

#### REAR AXLE HOUSING W/ BRACKETS INSTALLED

Description	Part#	
64" Track Housing with brackets welded on	RF-040-64-H	Upgrade
64" Track Fab. Housing with brackets welded on	FH-064-113	Upgrade

#### BRAKE OPTIONS

Description	Part#	
11" Heavy Duty Drum Brake	RN-054	Upgrade
12" Iron Rotors, GM Single Piston Calipers With Parking Brake	DR-005-E-P	Upgrade
12" Wilwood Smooth Rotors & 4 Piston Black Calipers W/Parking Brake	DRE-005-P-B	Upgrade
12" Wilwood Smooth Rotors & 4 Piston Red Calipers W/Parking Brake	DRE-005-P-RED	Upgrade
12" Wilwood Smooth Rotors & 4 Piston Pol. Calipers W/Parking Brake	DRE-005-P	Upgrade
12" Wilwood Drilled Rotors & 4 Piston Black Calipers W/Parking Brake	DRE-005-P-D-B	Upgrade
12" Wilwood Drilled Rotors & 4 Piston Red Calipers W/Parking Brake	DRE-005-P-D-R	Upgrade
12" Wilwood Drilled Rotors & 4 Piston Pol. Calipers W/Parking Brake	DRE-005-P-D	Upgrade

# '67-'87 CHEVY C-10 HEAVY DUTY FRONT SUBFRAME



## NEW! BOLT-IN FULL FRONT SUSPENSION



**64" TRACK WIDTH**

Product is painted for catalog purposes only! All kits ship with Silver Powder Coated Springs - not shown.

### INCLUDED IN BASE KIT:

- 1-1/4" Upper Tubular Control Arms & 1-1/2" Lower Tubular Control Arms
- 11" Disc Brakes with Wilwood 4-Piston Calipers
- Choice of Stock or Dropped Mustang II Spindles
- Power Rack & Pinion
- Bolt-On 3x4 Crossmember made out of 7GA with an Internal Gusset for added strength
- Adjustable Billet Shocks and Silver Powder Coated Springs

Now Available!  
Double Adjustable  
Shocks

### COMPLETE BASE KIT

Description	Part#
67-72 C-10 Heavy Duty Front 64" TW	BX-603
73-87 C-10 Heavy Duty Front 64" TW	BX-660

### CONTROL ARM OPTIONS

Description	Part#	Included
1-1/4" Upper and 1-1/2" Lower Tubular Arm Kit	BS-081	Included

### BRAKE OPTIONS

Description	Part#	Included
11" Iron Rotors, Wilwood 4 Piston Black Calipers, Chevy Bolt	DF-202-C-B-K	Included
11" Iron Rotors, Wilwood 4 Piston Pol. Calipers, Chevy Bolt	DF-202-C-P-K	Included
11" Iron Rotors, Wilwood 4 Piston Red Calipers, Chevy Bolt	DF-202-C-RED-K	Included
11" Iron Rotors, Wilwood 4 Piston Black Calipers, Ford Bolt	DF-202-F-B-K	Included
11" Iron Rotors, Wilwood 4 Piston Polished Calipers, Ford Bolt	DF-202-F-P-K	Included
11" Iron Rotors, Wilwood 4 Piston Red Calipers, Ford Bolt	DF-202-F-RED-K	Included
11" Wilwood Smooth Rotors & 4 Piston Black Calipers	DFS-202-B	Upgrade
11" Wilwood Smooth Rotors & 4 Piston Polished Calipers	DFS-202-P	Upgrade
11" Wilwood Smooth Rotors & 4 Piston Red Calipers	DFS-202-RED	Upgrade
11" Wilwood Drilled Rotors & 4 Piston Black Calipers	DFS-202-D-B	Upgrade
11" Wilwood Drilled Rotors & 4 Piston Polished Calipers	DFS-202-D-P	Upgrade
11" Wilwood Drilled Rotors & 4 Piston Red Calipers	DFS-202-D-RED	Upgrade
12" Wilwood Drilled Rotors & 4 Piston Black Calipers	DFS-208-B	Upgrade
12" Wilwood Drilled Rotors & 4 Piston Polished Calipers	DFS-208-P	Upgrade
12" Wilwood Drilled Rotors & 4 Piston Red Calipers	DFS-208-RED	Upgrade
13" Wilwood Drilled Rotors & 6 Piston Black Calipers	DFS-206-B	Upgrade
13" Wilwood Drilled Rotors & 6 Piston Polished Calipers	DFS-206-P	Upgrade
13" Wilwood Drilled Rotors & 6 Piston Red Calipers	DFS-206-RED	Upgrade

### SPINDLE OPTIONS

Description	Part#	Included
Stock Spindles	MP-028	Included
2" Dropped Spindles	SP-101-K	Included

### RACK & PINION OPTIONS

Description	Part#	Included
Power Rack & Pinion 20:1 ratio, 3 turn lock to lock	ST-002-K	Included

### SHOCK & SPRING OPTIONS

Description	Part#	Included
Single Adjustable Billet Coil-Over Shock	CB-105-G	Included
Double Adjustable Billet Coil-Over Shock	CB-105-D-G	Upgrade
350# Silver Powder Coated 10" Spring	CSV-350-10	Included
400# Silver Powder Coated 10" Spring	CSV-400-10	Included
450# Silver Powder Coated 10" Spring	CSV-450-10	Included
500# Silver Powder Coated 10" Spring	CSV-500-10	Included
550# Silver Powder Coated 10" Spring	CSV-550-10	Included
600# Silver Powder Coated 10" Spring	CSV-600-10	Included

### ADDITIONAL OPTIONS

	Part#	Included
Motor Mount Stands for SBC, BBC, LS	MM-070	Upgrade
Urethane LS adapter Kit	MM-200	Upgrade
1" Solid Front Sway Bar with hardware	SB-213	Upgrade
Universal Transmission Cross Member	BX-630	Upgrade
Steering hook up kit for power rack to IDIDIT Column	SC-311	Upgrade

Order/Tech: 800-841-8188



HEIDTS® STREET ROD PARTS

# '67-'87 CHEVY C-10 HEAVY DUTY REAR 4-LINK



## NEW! BOLT-IN HEAVY DUTY 4-LINK



### COMPLETE BASE KIT

Product is painted for catalog purposes only! All kits ship with Silver Powder Coated Springs - not shown.



### COMPLETE BASE KIT

Description	Part#
67-72 C-10 Rear 4-Link with Axle Brackets	RB-112
67-72 C-10 Rear 4-Link less Axle Brackets (use if ordering our housing)	RB-112-H
73-87 Chevy C-10 Heavy Duty Rear	RB-114

### SHOCK OPTION

Description	Part#	
Single Adjustable Billet Coil-Over Shock	CB-105-G	Included
Double Adjustable Billet Coil-Over Shock	CB-105-D-G	Upgrade

### SPRING OPTIONS

Description	Part#	
200 lb 10" spring	CSV-200-10	Included
250 lb 10" spring	CSV-250-10	Included
300 lb 10" spring	CSV-300-10	Included
350 lb 10" spring	CSV-350-10	Included
400 lb 10" spring	CSV-400-10	Included

### 3RD MEMBER OPTIONS

Description	Part#	
Positraction 31 Spline 3.00 Ratio	BN-300-I-L	Upgrade
Positraction 31 Spline 3.25 Ratio	BN-325-I-L	Upgrade
Positraction 31 Spline 3.50 Ratio	BN-350-I-L	Upgrade
Positraction 31 Spline 3.70 Ratio	BN-370-I-L	Upgrade
Positraction 31 Spline 3.90 Ratio	BN-390-I-L	Upgrade
Positraction 31 Spline 4.11 Ratio	BN-411-I-L	Upgrade

### REAR AXLES 31 SPLINE

Description	Part#	
64" Track 31 Spline Axles, Pair	RC-041-64-31	Upgrade

### 4-LINK FEATURES:

- 64 inch track width
- Double adjustable link Tubes (1.75 inch 120 DOM)\*
- Rods Ends are 1 Inch (largest in Industry)\*
- Optional Fabricated (Star Wars) housing\*
- \* Industry Exclusive
- Adjustable ride Height\*
- Adjustable 3 position Pan Hard Bar\*
- Billet Aluminium Shock Mounts \*
- Built in Drive shaft Loop

Now Available!  
Double Adjustable  
Shocks

### REAR AXLE HOUSING W/ BRACKETS INSTALLED

Description	Part#	
64" Track Housing with brackets welded on	RC-040-64-H	Upgrade
64" Track Fab. Housing with brackets welded on	FH-064-112	Upgrade

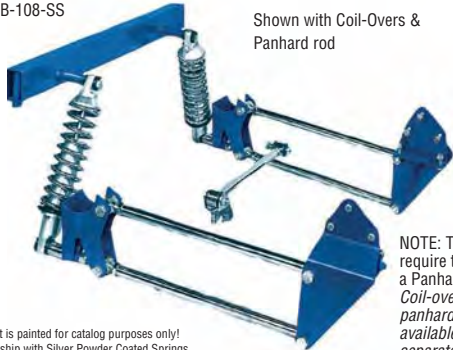
### BRAKE OPTIONS

Description	Part#	
11" Heavy Duty Drum Brake	RN-054	Upgrade
12" Iron Rotors, GM Single Piston Calipers With Parking Brake	DR-005-E-P	Upgrade
12" Wilwood Smooth Rotors & 4 Piston Black Calipers W/Parking Brake	DRE-005-P-B	Upgrade
12" Wilwood Smooth Rotors & 4 Piston Red Calipers W/Parking Brake	DRE-005-P-RED	Upgrade
12" Wilwood Smooth Rotors & 4 Piston Pol. Calipers W/Parking Brake	DRE-005-P	Upgrade
12" Wilwood Drilled Rotors & 4 Piston Black Calipers W/Parking Brake	DRE-005-P-D-B	Upgrade
12" Wilwood Drilled Rotors & 4 Piston Red Calipers W/Parking Brake	DRE-005-P-D-RED	Upgrade
12" Wilwood Drilled Rotors & 4 Piston Pol. Calipers W/Parking Brake	DRE-005-P-D	Upgrade



# REAR 4-LINK KITS

RB-108-SS



Shown with Coil-Overs & Panhard rod

NOTE: These kits require the use of a Panhard Rod. Coil-overs and panhard rod are available separately.

Product is painted for catalog purposes only! All kits ship with Silver Powder Coated Springs - not shown.

## CLASSIC TRUCK 4-LINK KITS

Coil-over, 4-Link rear suspension provides the best ride for any classic truck. These kits attach directly to the stock frame rails. The adjustable axle brackets let you set ride height in one of three positions. A bolt-in upper crossmember for coil-overs is included. Kits available in plain steel or with polished stainless steel.

Description	Part#
47-53 Chevy Pick-Up - Plain Bars	RB-108
47-53 Chevy Pick-Up - Polished Stainless Steel Bars	RB-108-SS
54-55 Chevy Pick-Up (1st Series) - Plain Bars	RB-109
54-55 Chevy Pick-Up (1st Series) - Polished Stainless Steel Bars	RB-109-SS
55-59 Chevy Pick-Up (2nd Series) - Plain Bars	RB-110
55-59 Chevy Pick-Up (2nd Series) - Polished Stainless Steel Bars	RB-110-SS
53-54 Ford F100 - Plain Bars (1st series only)	RB-120
53-54 Ford F100 - Polished Stainless Steel Bars (1st series only)	RB-120-SS
55-56 Ford F100 - Plain Bars	RB-121
55-56 Ford F100 - Polished Stainless Steel Bars	RB-121-SS

## STREET ROD TRIANGULATED 4-LINK KITS

Triangulated 4-Link Kits are very popular as they do not require a Panhard Rod. This design is also similar to many GM installations. Bars are fully adjustable, 1" X .156 tube with 3/4" stainless adjusters and urethane bushings, angled and straight chassis brackets, multi-position coil-over axle brackets, tabs and hardware. These kits are available in plain steel or polished stainless steel tubes.

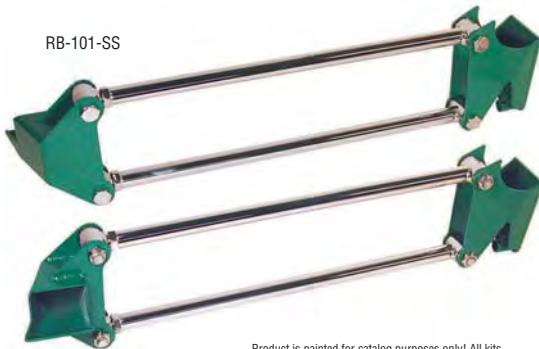
RB-201-SS



Product is painted for catalog purposes only! All kits ship with Silver Powder Coated Springs - not shown.

Description	Part#
Model A - Plain	RB-201
Model A - Polished Stainless Steel	RB-201-SS
32 Ford - Plain	RB-202
32 Ford - Polished Stainless Steel	RB-202-SS
33-34 Ford - Plain	RB-203
33-34 Ford - Polished Stainless Steel	RB-203-SS
Universal Triangulated 4-Link Kit	RB-201-U

RB-101-SS



Product is painted for catalog purposes only! All kits ship with Silver Powder Coated Springs - not shown.

## STREET ROD PARALLEL 4-LINK KITS

The Parallel 4-Link Kit is very easy to install and is a good choice for many installations. It uses 1" X .156 tube bars with 3/4" stainless adjusters and urethane bushings, chassis mounting brackets, multi-position coil-over axle brackets and hardware. NOTE: These kits require the use of a Panhard Rod. Intended for fully boxed or aftermarket frames.

Description	Part#
Model A - Plain	RB-101
Model A - Polished Stainless Steel	RB-101-SS
32-34 Ford - Plain	RB-102
32-34 Ford - Polished Stainless Steel	RB-102-SS

Owner: Scott Diedrich  
 Builder: Custom  
 Classics

# REAR 4-LINK KITS



A rear Panhard Rod is used to control lateral movement of the rear axle. It must be used when using a parallel 4-Link suspension kit. Bolt-on and weld-on models are available. Bolt-on models for Ford 8" & 9" rears only. Includes axle bracket, bar with stainless adjuster, urethane bushings and frame bracket. These are available with bar in plain steel tube, or polished stainless steel tube. Specify stock or centered housing for bolt-on kit.

## STREET ROD PANHARD RODS

Description	Part#
Universal Plain Weld-On	RP-101
Universal Polished Stainless Steel Weld-On	RP-101-SS
Universal Plain Bolt-On**	RP-102
Universal Polished Stainless Steel Bolt-On**	RP-102-SS
Model A - Plain	RP-111
Model A - Polished Stainless Steel	RP-111-SS
Model A - Plain Uncentered Housing	RP-111-UN
Model A - Polished Stainless Steel Uncentered Housing	RP-111-SS-UN
32 Ford - Plain	RP-112
32 Ford - Polished Stainless Steel	RP-112-SS
32 Ford - Plain Uncentered Housing	RP-112-UN
32 Ford - Polished Stainless Steel Uncentered Housing	RP-112-SS-UN
33-40 Ford - Plain	RP-113
33-40 Ford - Polished Stainless Steel	RP-113-SS
33-40 Ford - Plain Uncentered Housing	RP-113-UN
33-40 Ford - Polished Stainless Steel Uncentered Housing	RP-113-SS-UN

\*\*Bolt-On Kits For 8" and 9" Ford Housings Only

## CLASSIC TRUCK PANHARD RODS

Description	Part#
All Classic Trucks EXCEPT 47-54 Chevy Pick-Up	
Bolt-On Plain Panhard Bar Package**	RP-103
Bolt-On Polished Stainless Steel Panhard Bar Package**	RP-103-SS
Weld-On Plain Panhard Bar Package	RP-104
Weld-On Polished Stainless Steel Panhard Bar Package	RP-104-SS
<b>47-54 Chevy Pick-Up ONLY</b>	
Bolt-On Plain Panhard Bar	RP-105
Package** Bolt-On Polished Stainless Steel Panhard Bar Package**	RP-105-SS
Weld-On Plain Panhard Bar Package	RP-106
Weld-On Polished Stainless Steel Panhard Bar Package	RP-106-SS

\*\*Bolt-On Kits For 8" and 9" Ford Housings Only.

## COIL-OVER HARDWARE KITS

Use these hardware kits to install your Coil-Overs properly. Kit contains upper bolts, lower bolts, washers, nylon lock nuts and spacers. Available in both plain and polished stainless finish.

Description	Part#
Model A - Plain	HK-048
Model A - Polished Stainless Steel	HK-048-P
32-40 Ford - Plain	HK-049
32-40 Ford - Polished Stainless Steel	HK-049-P

## COIL-OVER CROSSMEMBERS

HEIDTS® also offers Coil-Over Upper Mounts and Coil-Over Crossmembers. The Upper Mounts are for Model A chassis, and Crossmembers are available for '32, '33-'34 and '35-'40 Fords.

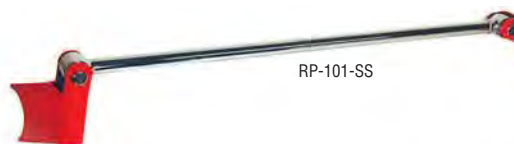
Description	Part#
Model A Upper Mounts	RB-051
'32 to '40 Ford Crossmembers	RB-052

## COIL-OVER SHOCKS

Description	Part#
Single Adjustable Billet Coil-Over Shocks	CB-105
Double Adjustable Billet Coil-Over Shocks	CB-105-D
Polished Billet Rear Coil-Over Shocks	CB-105-P

## SPRINGS

Description	Part#
250# Silver Powder Coated 11" Coil Springs	CSV-250-10
300# Silver Powder Coated 11" Coil Springs	CSV-300-10
350# Silver Powder Coated 11" Coil Springs	CSV-350-10



RP-101-SS



RP-102-SS



HK-048



RB-052



CB-105

# HEIDTS SUPERIDE® COIL-OVER SHOCKS



CO-101

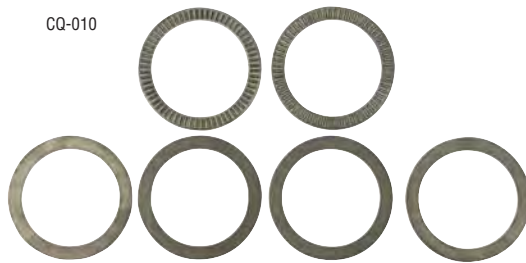
## HEIDTS SUPERIDE® REAR COIL-OVER SHOCKS

HEIDTS SUPERIDE® Rear Coil-over Shocks include urethane bushings, threaded lower spring seats, polished top cones and are available painted or Silver Powder Coated. Shocks are 10" compressed and 14-1/2" extended. Black Powder Coated or Silver Powder Coated plated springs in an assortment of progressive spring rates.

**Now Available!  
Double Adjustable  
Shocks**

- Adjustable Ride Height Spring Seats
- Available Painted and Powder Coated
- 5/8" Hard Chrome Shafts
- Urethane Bushings
- Progressive Rate Springs
- Silver Powder Coated Springs & Shock Bodies are also Available

Description	Part#
Black Coil-Over Shocks	CO-101
250# Black Coil Springs, Pair	CR-250-11-B
300# Black Coil Springs, Pair	CR-300-11-B
350# Black Coil Springs, Pair	CR-350-11-B
250# Silver Powder Coated Coil Springs, Pair	CR-250-11-C
300# Silver Powder Coated Coil Springs, Pair	CR-300-11-C
350# Silver Powder Coated Coil Springs, Pair	CR-350-11-C



CQ-010

## COIL-OVER SHOCK BEARINGS

Make changing the ride height on your vehicle simple with a set of our thrust bearings.

Description	Part#
Thrust Bearing for C/O Shocks	CQ-010

## SPANNER WRENCH

Description	Part#
Adjustable Spanner Wrench	TA-001
Fitted Spanner Wrench	TA-002



TA-002



TA-001



# HEIDTS SUPERIDE® BILLET COIL-OVER SHOCKS

## HEIDTS SUPERIDE® BILLET COIL-OVERS

HEIDTS SUPERIDE® Billet Coil-Over Shock Assemblies are available with plain or polished shock bodies. Springs are Silver Powder Coated on all coil-overs. Spring height adjustment is by a threaded spring seat and locking ring. Shock rate is adjustable using 20 position adjustment knob.

Now Available!  
Double Adjustable  
Shocks

Description	Part#
Single Adj. Coil-Over Shocks, 12 3/4" Extended, 10" Compressed	CB-101
Double Adj. Coil-Over Shocks, 12 3/4" Extended, 10" Compressed	CB-101-D
Polished Coil-Over Shocks, 12 3/4" Extended, 10" Compressed	CB-101-P
400# Silver Powder Coated Coil Springs	CSV-400-08
450# Silver Powder Coated Coil Springs	CSV-450-08
500# Silver Powder Coated Coil Springs	CSV-500-08
550# Silver Powder Coated Coil Springs	CSV-550-08
600# Silver Powder Coated Coil Springs	CSV-600-08
700# Silver Powder Coated Coil Springs	CSV-700-08
Single Adj. Coil-Over Shocks, 15 3/8" Extended, 11 1/2" Compressed	CB-105
Double Adj Coil-Over Shocks, 15 3/8" Extended, 11 1/2" Compressed	CB-105-D
Polished Coil-Over Shocks, 15 3/8" Extended, 11 1/2" Compressed	CB-105-P
250# Silver Powder Coated 11" Coil Springs	CSV-250-10
300# Silver Powder Coated 11" Coil Springs	CSV-300-10
350# Silver Powder Coated 11" Coil Springs	CSV-350-10
Single Adj. Coil-Over Shocks, 13 7/8" Extended, 10" Compressed	CB-106
Double Adj. Coil-Over Shocks, 13 7/8" Extended, 10" Compressed	CB-106-D
350# Silver Powder Coated 9" Coil Spring	CSV-350-09
400# Silver Powder Coated 9" Coil Spring	CSV-400-09
450# Silver Powder Coated 9" Coil Spring	CSV-450-09
500# Silver Powder Coated 9" Coil Spring	CSV-500-09



CB-101



MP-050

## HEIDTS SUPERIDE® BILLET MUSTANG II COIL-OVERS

HEIDTS Superide® Billet Coil-Over Shocks for Mustang II IFS. These shocks provide the highest quality ride characteristics for your Mustang II front end. They are designed for high performance comfort, with increased travel for better ride characteristics. Aluminum body have a bright anodized finish. 5/8" centerless ground solid piston rod, 10 position rebound valving adjuster. Spring height adjustment is by threaded spring seat and locking ring.

Description	Part#
Mustang II Single Adj Coil-Over Shocks, 10 7/8" Extended, 7 7/8" Compressed	MP-050
Mustang II Double Adj Coil-Over Shocks, 10 7/8" Extended, 7 7/8" Compressed	MP-050-D
Mustang II Coil-Over Shocks, Polished, 10 7/8" Extended, 7 7/8" Compressed	MP-050-P
375# Silver Powder Coated Coil Springs, Pair	MP-041
500# Silver Powder Coated Coil Springs, Pair	MP-042
600# Silver Powder Coated Coil Springs, Pair	MP-043
700# Silver Powder Coated Coil Springs, Pair	MP-044

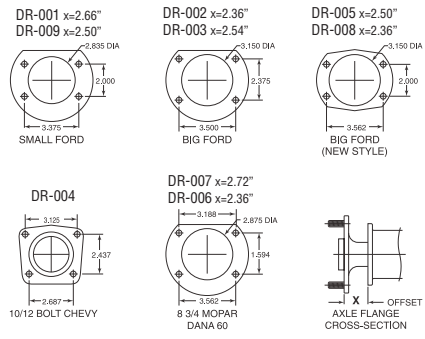
## SPANNER WRENCH

Description	Part#
Adjustable Spanner Wrench	TA-001
Fitted Spanner Wrench	TA-002



TA-002

# DISC BRAKES & BRAKE PARTS



## REAR DISC BRAKE KITS

For the ultimate in stopping power and appearance matching the performance of your front brakes. Our deluxe kit includes 12" smooth face .812 thick vented rotors. Also available slotted and crossdrilled. They come complete with four piston calipers, pads, mounting brackets, rotor assemblies, and all hardware. Our economy kits include plain rotors and single piston calipers. All kits include internal drum parking brake.

\*\*\*OTHER MANUFACTURER BRAKE KITS AVAILABLE. CALL FOR INFO.

## KITS WITH INTERNAL PARKING BRAKE

Description	Part#
12" Wilwood Smooth Rotors & 4 Piston Polished Calipers With Parking Brake	DRE-005-P
12" Wilwood Smooth Rotors & 4 Piston Black Calipers With Parking Brake	DRE-005-P-B
12" Wilwood Drilled Rotors & 4 Piston Polished Calipers With Parking Brake	DRE-005-P-D
12" Wilwood Drilled Rotors & 4 Piston Black Calipers With Parking Brake	DRE-005-P-D-B
12" Iron Rotors & GM Single Piston Calipers With Parking Brake	DRE-005-E-P
12" Wilwood Smooth Rotors & 4 Piston Red Calipers With Parking Brake	DRE-005-P-RED
12" Wilwood Drilled Rotors & 4 Piston Red Calipers With Parking Brake	DRE-005-P-D-RED



11" Disc Brake Conversion Kit

DF-201-C  
DF-201-F

These kits use the 11" rotors with a variety of caliper combinations. Kits are available as a bracket kit only or as a complete kit including calipers and rotors.

## MUSTANG II DISC BRAKE CONVERSION KITS

Description	Part#
Chevy Bolt Pattern Complete 11" Disc Brake Kit	DF-201-B-G
Ford Bolt Pattern Caliper Bracket Kit	DF-101-F
Ford Bolt Pattern Complete 11" Disc Brake Kit	DF-201-F-G
5 Bolt Circle Complete Disc Brake Kit	DF-201-5
5 1/2 Bolt Circle Complete Disc Brake Kit (must be sold with DF-5.5A)	DF-201-5.5
4 Piston Caliper Bracket Kit	DF-102
4 Piston Caliper Complete Disc Brake Kit*	DF-202

\*Please specify bolt pattern.



9 1/4" 5 Lug Rotors

MP-010

MP-008  
MP-009

## 9 1/4 MUSTANG II ROTORS - 5 LUG

Convert your rod to 5-bolt pattern wheels the safe and easy way. For '74-'78 Mustang II factory suspensions.

- Direct replacement – no adapters required
- Uses standard Mustang II bearings and seals

Description	Part#
Chevy Bolt Pattern Rotors	MP-008
Ford Bolt Pattern Rotors	MP-009
Bearing and Seal Kit	MP-010

**HEIDTS® CARRIES A FULL LINE OF REPLACEMENT BRAKE PADS.**



# DISC BRAKES & BRAKE PARTS

## 11" 4 PISTON MUSTANG II BRAKES

11" Billet Brake Kit includes Wilwood 4 Piston Calipers and Plain or Crossdrilled & Slotted Rotors.

Description	Part#
11" Wilwood Smooth Rotors & 4 Piston Black Calipers	DFE-202-B
11" Wilwood Smooth Rotors & 4 Piston Polished Calipers	DFE-202-P
11" Wilwood Smooth Rotors & 4 Piston Red Calipers	DFE-202-R
11" Wilwood Drilled Rotors & 4 Piston Black Calipers	DFE-202-D-B
11" Wilwood Drilled Rotors & 4 Piston Polished Calipers	DFE-202-D-P
11" Wilwood Drilled Rotors & 4 Piston Red Calipers	DFE-202-D-R



DF-202-P



DF-202-D-P

## 12" 4 PISTON MUSTANG II BIG BRAKES

12" Big Brake Kit with Wilwood Billet 4 Piston Calipers, Polished Aluminum Hubs with Crossdrilled & Slotted Rotors.

Description	Part#
12" Wilwood Drilled Rotors & 4 Piston Black Calipers	DFE-208-B
12" Wilwood Drilled Rotors & 4 Piston Polished Calipers	DFE-208-P
12" Wilwood Drilled Rotors & 4 Piston Red Calipers	DFE-208-R



12" 4 Piston Big Brake Kit  
DF-208-P



13" 6 Piston Big Brake Kit  
DF-206

## 13" 6 PISTON MUSTANG II BIG BRAKES

Have the biggest brakes in town! HEIDTS® offers the Wilwood 6 piston calipers installed on huge 13" directional vented rotors.

Description	Part#
13" Wilwood Drilled Rotors & 6 Piston Black Calipers	DFE-206-B
13" Wilwood Drilled Rotors & 6 Piston Polished Calipers	DFE-206-P
13" Wilwood Drilled Rotors & 6 Piston Red Calipers	DFE-206-RED

## BRAKE CALIPERS

Billet Aluminum Calipers are available separately. Calipers are four piston type, for .875 thick rotors. They come complete with pads and are ready to install.

Description	Part#
Black Caliper With Pads, Each	DF-049-B
Red Caliper With Pads, Each	DF-049-R
Smooth Polished Caliper With Pads, Each	DF-049-SM
Wilwood Caliper Brake Pads (Each)	DF-051
Single Piston Caliper Set With Pads, Pair	DF-009



DF-049-SM



DF-049-B



DF-049-R



DF-009

## TANDEM MASTERCYLINDER

WILWOOD™ Tandem Master Cylinders have ports on both sides for easy brake line plumbing, with 7/8" and 1-1/8" bore size. Available in both plain or polished finish.

Description	Part#
Plain 7/8" Bore Tandem Master Cylinder	DB-132
Polished 7/8" Bore Tandem Master Cylinder	DB-132-P
Plain 1" Bore Tandem Master Cylinder	DB-130
Polished 1" Bore Tandem Master Cylinder	DB-130-P
Plain 1-1/8" Bore Tandem Master Cylinder	DB-131
Polished 1-1/8" Bore Tandem Master Cylinder	DB-131-P



DB-132

## WHEEL FIT™ PROFESSIONAL 45 KIT

The Wheel Fit™ Professional 45 will fit most all 4- and 5- lug vehicles including bolt circles ranging from 4-100mm up to 4-130mm and 5-100mm up to 5-135mm. This kit will extend from 14" – 20" in tire bead diameter. It will also extend from 6.5" – 16" in width.

Description	Part#
Wheel Fit™ Professional 45 Kit	AS-111

AS-111



# BRAKE PARTS



## PROPORTIONING VALVE AND CHECK VALVES

An adjustable brake proportioning valve is used to balance front and rear brake pressures, especially in disc/drum combinations. One is also required in disc/disc applications, considering that 60% of the braking force transfers to the front wheels, and most street rods run big and little tires. 10 lb. residual pressure valve is used to maintain pressure in rear drum brake lines. 2 lb. residual pressure valve is used in some factory caliper applications, such as 'Vette calipers.

Description	Part#
Proportioning Valve	DR-020
Adjustable Proportioning Valve	DR-023
2# Residual Pressure Valve	DR-021
10# Residual Pressure Valve	DR-022



## STAINLESS STEEL BRAIDED BRAKE LINE KITS

- Made of braided stainless steel (-3 hose size) many times stronger and more abrasion resistant than factory rubber hoses. Uses -3AN fitting on frame side of brake line.
- Adds to the high tech look.
- Includes caliper adapters and seal washers.

Description	Part#
Stainless Steel Brake Line Kit - Mustang II Calipers (16" Long)	MP-030
Stainless Steel Brake Line Kit - GM Calipers, Metric (14" Long)	DF-020
Stainless Steel Brake Line Kit - Wilwood Calipers (14" Long)	BX-055
Stainless Steel Brake Line Kit - Wilwood Calipers (16" Long)	BX-055-1



## ADJUSTABLE PROPORTIONING VALVE

Adjustable proportioning valve regulates rear brake pressure, helping to maintain correct brake bias between front and rear brakes.

Description	Part#
Adjustable Proportioning Valve	DR-023

## THRU FRAME BRAKE LINE FITTINGS

Thru Frame Brake Line Fittings are available in stainless steel to complete your brake line hook-up. Short fittings are for frame thickness 1-1/8" to 2". Long Fittings are for frame thickness 1-1/2" to 2-3/8". Fittings have 1/8" NPT female thread on inside frame end and -3AN male fitting on outside. Weld-in fittings are plain steel with 1/8" NPT female threads on both ends, 2-1/4" long. Bulkhead fittings also available for single thickness frames with -3AN male fittings on both ends. Other adapter fittings available.



Description	Part#
90 Degree Fitting, -3AN to 1/8" NPT	LF-004
Weld-on Tab, Each	LF-011
Fitting, -3 An To 3/16 Inverted Flair, Each	LF-012
Tab Fitting Clip, Each	LF-013
Banjo Fitting, 10mm to -3", Each	LF-014
10mm Banjo Fitting Bolt, Each	LF-015-A
10mm Banjo Fitting Washer, Each	LF-015-W
Thru Frame Fitting Weld-In Kit 1/8" NPT to 1/8" NPT (2-1/8" Long)	LF-018-1
Thru Frame Fitting Weld-In Kit 1/8" NPT to 1/8" NPT (2-1/4" Long)	LF-018-2
Thru Frame Fitting Weld-In Kit 1/8" NPT to 1/8" NPT (2-1/2" Long)	LF-018-3
Thru Frame Fitting Weld-In Kit 1/8" NPT to 1/8" NPT (3-1/4" Long)	LF-018-4
Inverted Flare T-Fittings (3/16)	LF-020
Thru Frame Kit, Short -3 AN to 1/8" NPT	LK-001
Thru Frame Kit, Long -3 AN to 1/8" NPT	LK-002
Thru Frame Bulkhead Kit, -3 AN to -3AN"	LK-005
Weld-On Tab Fitting Kit, -3AN To 3/16 Inverted Flair	
Fittings With Tabs & Clips	LK-007
Banjo Bolt Kit - Bolts & Washers (10mm)	LK-008
Banjo Fittings, 10MM to -3AN	LK-009
Banjo Bolt Kit, 7/16-20 to -3AN	LK-010
Banjo Fittings, 7/16 to -3AN	LK-011
Adapters, -4 Male to 45 Swivel	LK-012
Adapters, -3AN to 1/8" NPT Male	LK-013
Adapters, -4AN to 1/8" NPT Male	LK-014

(Note: Adapter fittings sold as pairs)

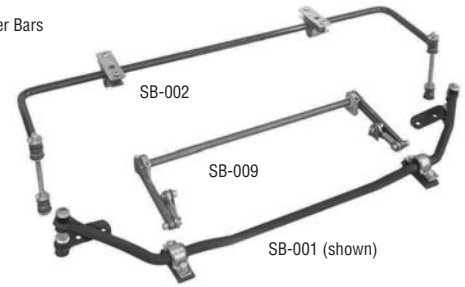
# MOTOR MOUNTS, STABILIZER BARS & MUSTANG PARTS

Stabilizer bars are used to control body roll. **HEIDTS®** has an assortment of front and rear bars for your particular application. Made of heat treated steel, these bars will help make your car more stable.

## STABILIZER BARS

Description	Part#
<b>Front SWAY BARS</b>	
<b>Camaro Pro-G® Subframe Only</b>	
67-81 Camaro/68-72 Nova (1" Diameter)	SB-110
67-81 Camaro/Firebird/68-72 Nova (1-1/4" Diameter)	SB-111
67-81 Camaro/Firebird/68-72 Nova (1-1/4" Diameter-Splined)	SB-401
<b>Camaro Stock Subframe Only</b>	
67-69Camaro/Firebird/68-72 Nova (1-1/8" Diameter)	SB-069
70-81 Camaro/Firebird (1-5/16" Diameter)	SB-070
<b>Chevelle &amp; GM A-Body</b>	
64-72 Chevelle/A-Body	SB-071
<b>Classic Truck Superide II Only 53-56</b>	
Ford/55-59 Chevy	BS-054-RS
53-56 Ford/55-59 Chevy (Chrome)	BS-054-C-RS
<b>Fairlane/Comet Superide II Only</b>	
66-67 Fairlane/66-67 Comet	SB-190
<b>Mustang/Cougar with HEIDTS® Mustang II Only 64 1/2-70 Mustang/67-70 Cougar</b>	
	SB-065
<b>Mustang Superide II &amp; Nova Superide II Only</b>	
64 1/2-70 Mustang/62-67 Nova	BS-061
64 1/2-70 Mustang/62-67 Nova (Narrowed)	BS-061-N
64 1/2-70 Mustang/62-67 Nova (Chrome)	BS-061-C
64 1/2-70 Mustang/62-67 Nova (Chrome Narrowed)	BS-061-C-N
<b>Nova Mustang II Subframe</b>	
Only 62-67 Nova	SB-060
<b>Street Rod Openwheel Superide</b>	
Only 32 Ford	BS-053
32 Ford (Chrome)	BS-053-C
<b>Street Rod Mustang II Only</b>	
35-40 Ford*	SB-001
37-39 Chevy	SB-003
40-48 Chevy	SB-004
49-54 Chevy	SB-005
47-54 Chevy Pick-Up	SB-054
41-48 Ford	SB-006
48-54 Ford Pick-Up, 53-56 Ford F100	SB-007
*SB-001 Fits 33-34 Fords ONLY with a relocation of mounting holes in frame	
<b>Street Rod Superide Only</b>	
32 Ford/33-34 Ford/34-35 Chevy/Model A	BS-055
32 Ford/33-34 Ford/34-35 Chevy/Model A	BS-055-C
<b>Street Rod Superide II Only</b>	
35-40 Ford/41-48 Ford/40-48/Chevy/40-46 Chevy Pick-upUp/47-54 Chevy Pick-up	
Plain Sway Bar	BS-056
Narrowed Sway Bar	BS-056-N
Chrome Sway Bar	BS-056-C
Chrome Narrowed Sway Bar	BS-056-C-N
37-41 Willys Must Use Narrowed Swaybar Only AND Are For Outlaw And IDA Chassis Only	
<b>55 - 57 Chevy Only</b>	
55-57 Chevy (7/8" Diameter With Urethane Bushings)	SB-050-U
55-57 Chevy (1" Diameter With Urethane Bushings)	SB-051-U

Stabilizer Bars



Description	Part#
<b>Rear SWAY BARS</b>	
<b>Camaro 4-Link Only</b>	
67-69 Camaro/Firebird & 68-72 Nova Rear Swaybar (For Use With HEIDTS® 4-Link Kit Only)	SB-009
70-81 Camaro/Firebird Rear Swaybar (For Use With HEIDTS® 4-Link Kit Only)	SB-170
<b>Chevelle &amp; GM A-Body</b>	
64-72 Chevelle/GM A-Body Rear Swaybar (For Use With HEIDTS® 4-Link Kit Only)	SB-150
<b>55 - 57 Chevy (Stock Suspension) Only</b>	
55-57 Chevy (7/8" Diameter With Urethane Bushings)	SB-052
<b>55 - 57 Chevy Triangular 4-Link Only</b>	
55-57 Chevy (For Use With HEIDTS® 4-Link Kit Only)	SB-180 55-57
Chevy (Chrome) (For Use With HEIDTS® 4-Link Kit Only)	SB-180-C
<b>Nova Rear 4-Link</b>	
62-67 Nova (For Use With HEIDTS® 4-Link Kit Only)	SB-130
<b>Street Rod</b>	
35-40 Ford (Twin Leaf)	SB-002
Universal Rear	SB-009

**NOTE:** These bars can fit numerous applications with modifications to mounts

Now you can add a stabilizer bar to your Mustang II IFS. This simple bracket kit bolts onto control arms. Available in plain, or polished stainless steel.

## STABILIZER BAR BRACKET KIT

Description	Part#
Bracket Kit For Stock Lower Control Arms	SB-010
Bracket Kit For HEIDTS® Tubular Full Lower A-Arms	SB-012
Polished Stainless Steel Bracket Kit For HEIDTS® Tubular Full Lower A-Arms	SB-012-SS
Left Weld-On Bracket Only	CA-230-L
Right Weld-On Bracket Only	CA-230-R



Stabilizer Bar Bracket Kit, SB-012 SS



MM-110

## MOTOR MOUNTS

Description	Part#
Universal Motor Mount Kit	MM-110
Nova Subframe Motor Mounts Only, Pair	MM-120
64-1/2-67 Mustang Motor Mount Stands, Pair	MM-130
Superide II Motor Mount Stands For Small Block Ford, Pair	MM-131
Motor Mounts For Ford Small Block, Pair	MM-135
Motor Mount Kit Ford	MM-140

# STEERING KITS & COMPONENTS

HEIDTS® steering column hook-up kit is the perfect companion for your independent front end. In fact, it's the strongest, highest quality kit on the market.

## WHY IT'S BETTER

- Automotive grade U-joints, w/needle bearing construction, the safest ones available.
- Designed for the automobile environment, they will last the life of your car.
- U-Joints double pinned at each connection for safer, stronger assembly.
- Correct two-piece shaft design allows for ample engine clearance.
- No welding or machining required-column can stay in car during installation.



## IIDIT STEERING COLUMNS

Description
Mustang Tilt Floor Shift Collapsible
68-69 Mustang - Paintable Steel
68-69 Mustang - Black Powder Coated
68-69 Mustang - Chrome
Nova Tilt Floor Shift
62-66 Nova - Paintable Steel
67 Nova - Paintable Steel
62-66 Nova - Black Powder Coated
67 Nova - Black Powder Coated
62-66 Nova - Chrome
67 Nova - Chrome
Nova Tilt Floor Shift With Ignition 69-73
Nova - Paintable Steel
69-73 Nova - Chrome
69-73 Nova - Black Powder Coated
Camaro Tilt Floor Shift
67-68 Camaro - Paintable Steel
67-68 Camaro - Black Powder Coated
67-68 Camaro - Chrome
Camaro Tilt Floor Shift With Ignition 69
Camaro - Paintable Steel
69 Camaro - Black Powder Coated
69 Camaro - Chrome
Chevy Tilt Floor Shift
55-56 Chevy - Paintable Steel
57 Chevy - Paintable Steel
55-56 Chevy - Black Powder Coated
57 Chevy - Black Powder Coated
55-56 Chevy - Chrome
57 Chevy - Chrome
Chevy Truck Tilt Floor Shift
47-54 Chevy Truck - Paintable Steel
47-54 Chevy Truck - Black Powder Coated
47-54 Chevy Truck - Chrome
Ford Truck Tilt Floor Shift
53-56 Ford Truck - Paintable Steel
53-56 Ford Truck - Black Powder Coated
53-56 Ford Truck-Chrome
32" Universal Tilt Floor Shift Steel
Black Powder Coated
Chrome

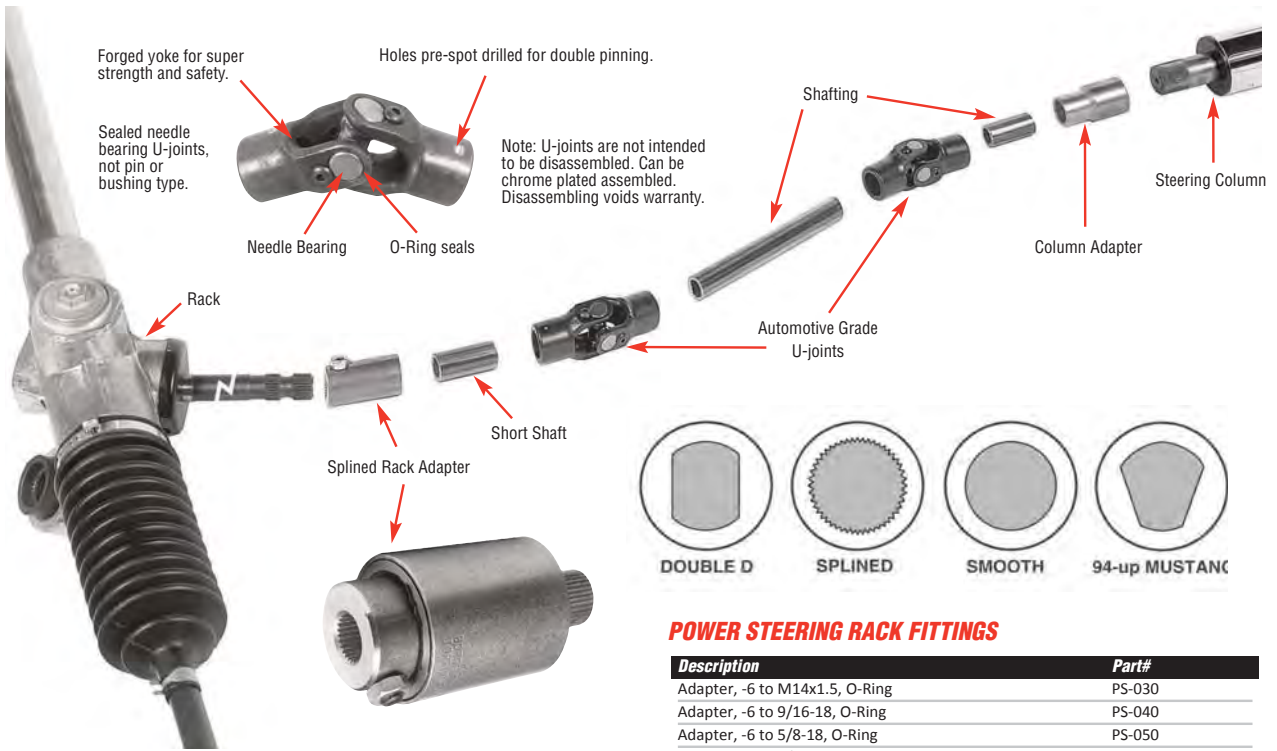
## COMPLETE RACK & PINION KIT INCLUDES:

- Splined adapter for the rack end. Specify manual or power steering.
- Two lengths of high quality shafting.
- Two needle bearing automotive type universal joints.
- Machined adapter for steering column (1" column standard. Splined adapter available for other sizes).
- Roll pins supplied in correct lengths. Two pins per connection provided for extra safety.
- Step-by-step instructions.

## INDIVIDUAL COMPONENTS

Description	Part#
3/4" Rod End Bearing	SC-020
<b>U-Joints</b>	
3/4" DD to 3/4" 36 Spline	SC-040
3/4" DD to 3/4" V Notch	SC-050
3/4" DD to Manual Rack	SC-060
3/4" DD to 1" DD	SC-070
3/4" to 3/4"	SC-210
3/4" to 1" 48 Spline	SC-211
1" DD to 3/4"	SC-212
3/4" DD to 3/4" Bore	SC-213
17mm DD to 3/4"	SC-217
3/4" to 5/8" 38 (Vega) Spline	SC-310
3/4" to 9/16" 26 Mustang Manual Spline	SC-410
3/4" to 3/4" 36 Mustang Power Spline	SC-510
3/4" DD to 17mm DD	SC-306
3/4" DD to 1" 48 Spline	SC-980
3/4" to 3/4" 30 Spline	SC-610
3/4" to 13/16" 36 Spline	SC-710
3/4" 36 Spline to 3/4" 36 Spline	SC-810
3/4" to 3/4" V Notch	SC-950
3/4" 36 Spline to 3/4" V Notch	SC-960
3/4" DD to 3/4" DD	SC-970
<b>Adapters</b>	
1" Spline to 3/4" Smooth	SC-101
1" DD to 3/4" DD	SC-102
9/16" 26 to 3/4" Manual Rack	SC-201
3/4" 36 to 3/4" Power Rack	SC-202
3/4" to 3/4"	SC-206
3/4" to 13/16" 36 Spline	SC-207
3/4" to 5/8" 38 (Vega) Spline	SC-208
3/4" to 3/4" DD	SC-214
3/4" to 17mm DD	SC-215
3/4" to 1" DD	SC-216
67 Nova (Splined Adapter)	SC-218
<b>Shafts</b>	
6" Short 3/4" Smooth Shaft (Mustang/Pinto)	SC-203
6" Short 3/4" DD Shaft	SC-203-DD
32" Long 3/4" Smooth Shaft (Mustang/Pinto)	SC-204
32" Long 3/4" DD Shaft	SC-204-DD
16" Shaft 3/4" DD	SC-209-DD
24" Long Shaft (Vega)	SC-303





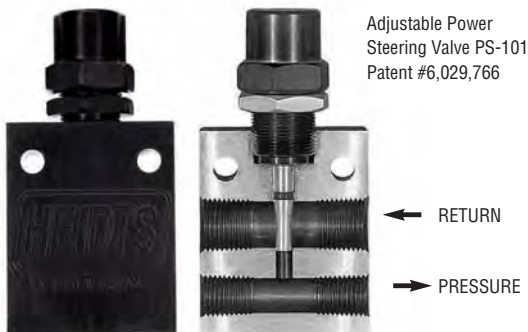
**POWER STEERING RACK FITTINGS**

Description	Part#
Adapter, -6 to M14x1.5, O-Ring	PS-030
Adapter, -6 to 9/16-18, O-Ring	PS-040
Adapter, -6 to 5/8-18, O-Ring	PS-050
Adapter, -6 to 1/2-20, O-Ring	PS-060
Adapter, -6 to M18x1.5, O-Ring	PS-065
Banio Bolt Kit for BS-004-NPS Rack, 14 & 16MMx 1.5 to 6AN	620510

**ADJUSTABLE POWER STEERING VALVE**

Tune your power steering with our Adjustable Power Steering Valve. It allows you to set, or "tune", the "feel" of your power steering with just the turn of a knob. The high pressure steering fluid goes thru the lower high pressure passage to the rack and back thru the upper low pressure line to the reservoir. As the knob is turned counter - clockwise, the needle valve is raised up which allows the high pressure fluid to bleed off into the return line, which reduces pressure to the rack and pinion to tighten the feel of the steering.

Description	Part#
Adjustable Power Steering Valve	PS-101
Installation/fittings Kit (included in hose kits)	PS-114
Power Steering Valve With Gauge	PS-102



PS-101

**POWER STEERING HOSE KITS**

Description	Part#
GM Integral Reservoir Pumps for use without valve	PS-110
GM Remote Reservoir Pump for use without valve	PS-111
GM Integral Reservoir Pumps for use with valve	PS-112
GM Remote Reservoir Pumps for use with valve	PS-113
Installation/fittings Kit (included in hose kits)	PS-114



**MUSTANG II REPLACEMENT PARTS FOR ORIGINAL FACTORY ARMS**



MP-049 Complete Kit

**COMPLETE KIT INCLUDES:**  
MP-011, MP-014, MP-012, MP-015 (2), MP-013, MP-016 (2)

**MUSTANG II REPLACEMENT PARTS - INDIVIDUAL COMPONENTS**



MP-011  
Strut Rod Bushing Kit

MP-012-P  
Urethane Steering Rack  
Bushings (Pair)

MP-013  
Upper Arm Bushings (Pair)

MP-014  
Lower Arm Bushings (Pair)

MP-015 Upper Ball Joint (Ea.)

MP-016 Lower Ball Joint (Ea.)



**COIL SPRINGS**

**Description Part# Price**

- Coil Springs, Pr. (300#) MP-007-300
- Coil Springs, Pr. (350#) MP-007-350
- Coil Springs, Pr. (375#) MP-007-375



**UPPER SPRING CUSHIONS**

Description	Part#
Upper Spring Cushions, Pr.	MP-006



**SHOCK ABSORBERS**

Description	Part#
Plain Shocks, Pr.	MP-005

**HARDWARE KITS**



MP-001 Basic Bolt Kit  
(Includes, MP-001-A)



MP-001-A Upper Arm Kit Only



MP-002 Caliper Bolt Kit



Spindle Nut Kit  
HK-006



Tie Rod Ends Stainless Steel  
MP-017-SS 64.00 Each Plain  
MP-017



**SPRING SPACERS**

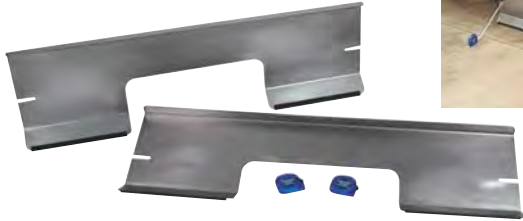
Cut too much off your Mustang II springs, or have your springs settled just a little too much? HEIDTS® Spring Spacers will get you back in shape. Use these 3/4" thick spacers in place of your upper spring cushions to add just a little ride height back in your ride. Sold in pairs.

Description	Part#
Spring Spacers, Pr.	MP-060

**TOE-IN ALIGNMENT PLATES**

Toe alignment Plates allow you to set your toe-in correctly and quickly, by yourself. No more bending under your car and measuring across the tire treads with your buddies! It is all done outside the tires. They come with two plates and two tape measurers, to accurately check your toe-in.

Description	Part#
Toe -In Alignment Plates, Set	TA-003



**4" RACK AND PINION EXTENSION KIT**



MP-037-4

For use with PX-104, 104-E, 105, 105-E, CX-308, 308-E, KX-102, 102-E IFS Kits

Description	Part#
Manual	MP-037-1-4
Power	MP-039-4

MP-018-1-K



MP-038-3-K



**REPLACEMENT RACK AND PINIONS**

Description	Part#
Mustang II Rack and Pinion, Manual	MP-018-1-K
Power Rack	MP-038-3-K
Heidts Superide® Rear Steer Manual Rack	BS-004
Heidts Superide® Rear Steer Power Rack	BS-004-NPS

**HEIDTS MUSTANG II TUBULAR CONTROL ARMS REPLACEMENT PARTS**

Description	Part#
Rebuild Bushing Package	CA-360
Upper Urethane Bushings	CA-240
Lower Urethane Bushings	CA-241
Ball Joint Boots	CA-029
Power Rack Polyurethane Bushings	MP-012P



CA-240

**HEIDTS SUPERIDE TUBULAR CONTROL ARMS REPLACEMENT PARTS**

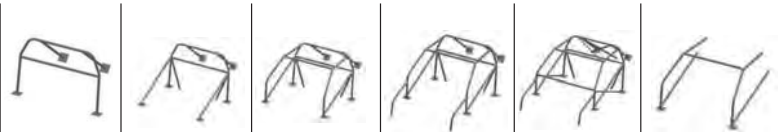
Description	Part#
Bushings	BX-017
Superide II Ball Joints	CA-013
Superide Ball Joints	BX-015
Superide II Ball Joint Boots	CA-029
Power Rack Polyurethane Bushings	MP-012P



CA-013



# ROLL BAR & CAGES



YEAR	APPLICATION	4PT BAR	8PT BAR	8PT CAGE	10PT CAGE	12PT CAGE	CAGE CONV.
67-69	CAMARO/FIREBIRD	101010	101110	101210	101910	101310	101410
70-81	CAMARO/FIREBIRD	101011	101111	101211	101911	101311	101411
82-92	CAMARO/FIREBIRD	101025	101125	101225	101925	101325	101425
93-02	CAMARO/FIREBIRD	101054	101154	101254	101954	101354	101454
64-73	MUSTANG/COUGAR	101012	101112	101212	101912	101312	101412
79-93	MUSTANG/CAPRI	101024	101124	101224	101924	101324	101424
74-78	MUSTANG II	101032	101132	101232	101932	101332	101432
63-82	CORVETTE	101028	101128	101228	101928	101328	101428
53-62	CORVETTE	101029	101129	101229	101929	101329	101429
71-76	AMC GREMLIN	101037	101137	101237	101937	101337	101437
68-70	AMX	101050	101150	101250	101950	101350	101450
48-53	ANGLIA	101038	101138	101238	101938	101338	101438
75-80	ARROW/COLT	101022	101122	101222	101922	101322	101422
88-91	BERRETTA	101047	101147	101247	101947	101347	101447
72-77	CAPRI	101039	101139	101239	101939	101339	101439
64-72	CHEVELLE/GTO/442	101027	101127	101227	101927	101327	101427
73-77	CHEVELLE/GTO/442	101036	101136	101236	101936	101336	101436
55-57	CHEVY	101026	101126	101226	101926	101326	101426
62-67	CHEVY II/NOVA	101017	101117	101217	101917	101317	101417
73-79	CHEVY FULL SIZE P/U	101046	101146	101246	101946	101346	101436
90-94	CHEVY FULL SIZE P/U	101048	101148	101248	101948	101348	101448
95-04	CHEVY FULL SIZE P/U	101051	101151	101251	101951	101351	101451
80-89	CHEVY FULL SIZE P/U	101052	101152	101252	101952	101352	101452
83-91	CHEVY S-10 P/U	101045	101145	101245	101945	101345	101445
70-74	CHRYSLER E-BODY						
	CUDA/CHALLENGER	101014	101114	101214	101914	101314	101414
62-72	CHRYSLER B-BODY						
	BELVEDERE/GTX	101018	101118	101218	101918	101318	101418
68-75	CHRYSLER A-BODY						
	DART/DUSTER	101013	101113	101213	101913	101313	101314
91-97	DODGE STEALTH	101049	101149	101249	101949	101349	101449
70-75	MAVERICK/COMET	101016	101116	101216	101916	101316	101416
66-67	FAIRLANE	101034	101134	101234	101934	101334	101434
78-83	FAIRMONT	101033	101133	101233	101933	101333	101433
64-65	FALCON/COMET	101019	101119	101219	101919	101319	101419
68-70	FORD GALAXY	101057	101157	101257	101957	101357	101457
71-76	GREMLIN	101037	101137	101237	101937	101337	101437
61-64	IMPALA	101055	101155	101255	101955	101355	101455
68-74	JAVELIN	101040	101140	101240	101940	101340	101440
76-80	LUV TRUCK	101042	101142	101242	101924	101342	101442
98-05	BEETLE	101056	101156	101256	101956	101356	101456
78-80	VOLARE/ASPEN/CORDOBA	101023	101123	101223	101923	101323	101423
71-80	VEGA/ASTRE/MONZA	101021	101121	101221	101921	101321	101421
78-85	GM G-BODY MONTE CARLO	101030	101130	101230	101930	101330	101430
80-86	NISSAN/DATSUN 1/2 TON	101043	101143	101243	101943	101343	101443
68-72	NOVA/VENTURA	101015	101115	101215	101915	101315	101415
71-80	PINTO/BOBCAT	101020	101120	101220	101920	101320	101420
62-68	RAMBLER	101041	101141	101241	101941	101341	101441
83-88	T-BIRD/COUGAR	101044	101144	101244	101944	101344	101444
37-42	WILLYS	101035	101135	101235	101935	101335	101435
08-13	CHALLENGER	101064	101164	-	-	-	-

ALL ROLL CAGES ALSO AVAILABLE IN CHROMOLY



Order/Tech: 800-841-8188

# ROLL BAR & CAGE ACCESSORIES

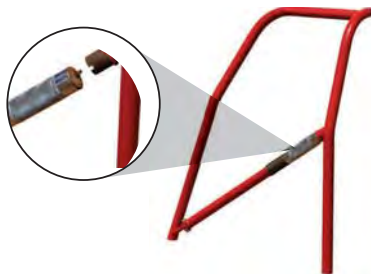
## DELUXE SWING OUT SIDEBAR

Our unique spring loaded latching mechanism does the rest. Once the latch is fully engaged the chrome plated safety slider springs into place locking the side bar securely in place.

#101520

(For 1 5/8" x .134 wall tubing only)  
NHRA legal to 8.50

Simply pull it shut! LATCHES ITSELF!!



## X-BRACE REAR FRAME STRENGTHENING KIT

Most popular Pro Gas configuration. Adds a lightweight ALSTON X-Brace and extended rear struts to standard ALSTON 8 and 10 point roll cages, increasing chassis stiffness and rear frame support. The X-Brace's 1 5/8" diameter (.134") tubing matches ALSTON'S standard roll cage O.D. Instructions included.



#101510

## STANDARD SWING OUT SIDE BAR KIT

This design makes existing fixed side bar fully removable or simply swing out for ease of entry or exit. The kit comes complete with precision machined clevises, weld-on brackets and bolts.

#101519



## FORWARD STRUT CONVERSION

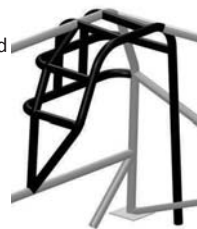
Eliminates firewall flex common to uni-body cars, and ties the front and rear chassis together through the roll cage. Two kits are available for either strut or A-Arm equipped chassis.

#141130 Long  
#141131 Short



## FUNNY CAR CAGE CONVERSION

Available in mild steel or 4130 steel, for use with all ALSTON chassis. Kit contains bent and straight tubes to convert your roll cage to a funny car style cage as shown. Because this type of cage will greatly restrict driver movement and access to the transmission, its use should be thoroughly considered before installation in full bodied cars.



Item	Description
101523	Funny Car Cage Conversion Pro-Link - Mild Steel
101524	Funny Car Cage Conversion Pro-Link - 4130 Moly
101514	Funny Car Cage Conversion - mild steel*
101515	Funny Car Cage Conversion - 4130 moly*
101517	Auxiliary Side Cage - Mild Steel
101518	Auxiliary Side Cage - 4130 moly

## AUXILIARY SIDE CAGE

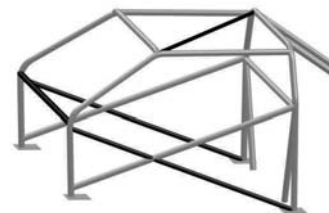
This kit provides all the material necessary to install the additional bars required for improved head protection.



## ROLL CAGE STRENGTHENING KIT

A three-step addition that provides strength and rigidity to your 8 point roll cage. Improves side and upper cage impact resistance and increases firewall and chassis stiffness.

Included are a pair of side bars to X-brace the door panel area, upper cage triangular tubing, upper cage triangular tubing, dash board brace instructions.



#101511

## CONTOURED REAR STRUTS

Now you can have the added strength and security of a roll bar without losing the use of your rear seat. These innovative rear struts are contoured to run along the roof line and down through the package shelf attaching to the upper shock mount. An absolute must for street driven cars, these struts are made from 1 5/8" x .134" wall tubing and are designed for use with our 4 or 8 point roll bars



#101516

# CHASSIS

## THE ORIGINAL ALSTON PRO-GAS CHASSIS

Since the early 80's we have produced literally thousands of these chassis. They are available in many different combinations; Mild or 4130 Chrome Moly Steel, 1 5/8" round or 2" x 3" mandrel bent frame rails, A-Arm or Strut front suspension and Ladder Bar or 4-Link rear suspension. Available in all popular body styles.

Item	Description
101810	MS BX AM LB CMP CHASSIS
101811	MS BX AM LB INT CHASSIS
101812	MS BX ST LB CMP CHASSIS
101813	MS BX ST LB INT CHASSIS
101814	AS RF ST LB CMP CHASSIS
101815	AS RF ST LB INT CHASSIS
101834	MS RF AM LB CMP CHASSIS
101835	MS RF AM LB INT CHASSIS
101836	MS RF ST LB CMP CHASSIS
101837	MS RF ST LB INT CHASSIS
101838	AS BX ST LB CMP CHASSIS
101839	AS BX ST LB INT CHASSIS

### Intermediate Chassis

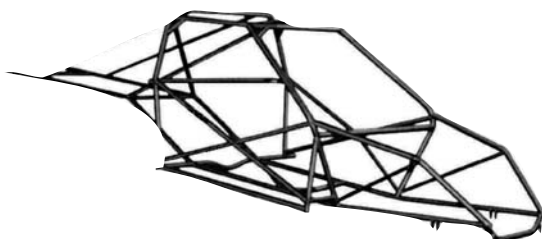
any chassis from 97"-115" wheelbase



2" X 3" Frame Rail A-Arm Ladder Bar

### Compact Chassis

any chassis from 92"-97" wheelbase



ROUND RAIL - STRUT (mild steel)

## PRO-LINK CHASSIS

It permits a significantly lower ride height, the installation of larger tires and is specifically designed for use with our Pro Link rear suspension. This round rail chassis is available in mild or 4130 steel, plus your choice of A-Arm or Strut front suspension. It is also available for all popular body styles, including Opel and Corvette.

Item	Description
101845	MS RF AM PL CMP CHASSIS
101846	MS RF ST PL CMP CHASSIS
101828	AS RF ST PL CMP CHASSIS
101847	MS RF AM PL INT CHASSIS
101848	MS RF ST PL INT CHASSIS
101830	AS RF ST PL INT CHASSIS
101841	MS RF AM PL OPL CHASSIS
101843	MS RF AM PL VET CHASSIS
101844	MS RF ST PL VET CHASSIS
101858	MS RF AM PL 55C CHASSIS
101859	MS RF ST PL 55C CHASSIS
101860	AS RF ST PL 55C CHASSIS
101862	MS RF AM PL CHEVELLE
101863	MS RF ST PL CHEVELLE
101864	AS RF ST PL CHEVELLE



Uses 71-72 Pinto  
A-Arm Front Suspension



Made For Use With Strut  
Front Suspension



## FRAME RAILS

These frame rails feature 2" x 3" rectangle or 1 5/8 round, mandrel bent tubing. Rear kick-up allows the use of 32" ladder bars or 4-link rear suspensions. Your choice of A-Arm or strut front suspension too. Available in 2 lengths and widths and includes dropped X-member, main, rack & pinion, shock and rear X-members. Rails for compact bodies are 24" wide and will accept up to 105" wheel base. Intermediate frames are 28" wide and handle up to 118" wheel base. Please specify: compact or intermediate. Strut or A-Arm front suspension.

Item	Description
101650	MS BX AM LB CMP frame rails & cross members
101651	MS BX AM LB INT frame rail & cross members
101652	MS BX ST LB CMP frame rails & cross members
101653	MS BX ST LB INT frame rails & cross members
101654	MS RF AM LB CMP frame rails & cross members
101655	MS RF AM LB INT frame rails & cross members
101656	MS RF ST LB CMP frame rails & cross members
101657	MS RF ST LB INT frame rails & cross members





# SNOUT KITS

## STRUT FRONT SNOUT KIT

Up to 300 lbs. lighter than the OEM Sub Frame and suspension it replaces. This frame snout kit is designed to accept racing type strut front suspension with rack-and-pinion steering. Benefits include, improved header clearance provisions for engine relocation, and easy oil pan removal.



Our exclusive one piece frame rail design make assembly a snap. Less cutting, less welding and less fixturing saves you a ton of time and money. Plus there is no chance of mismatched frame rails.

Complete package includes: one piece lower rail, front cage struts, rack and pinion mounting cross member, upper strut mounts, control arm mount brackets, rack and pinion mounts, detailed blue print and complete instructions.

*ALSTON manufactures a complete line of accessories for these kits.*

Item	Description
102024	Strut Front Snout Kit
PSS125	Strange Engineering Front Strut Package
FR1501	'71-'72 Rack and Pinion
181031	Billet Aluminum Rack Clamp
181410	Tie Rod Tube Adaptor
181418	Dual U-joint 4130 Steering Column Kit
102022-K	Complete Kit includes everything above

## A-ARM FRONT SNOUT

This simple conversion cuts 230 lbs. of sprung weight from the front of your car and lets you use the popular adjustable coil-over shocks. We rely on the lighter Pinto suspension parts because of the obvious compatibility with the pinto steering, plus the spindles and bearing bosses are stronger than the Vega units Found in other conversions. Spring rates 350 lbs. to 550 lbs. In 50 lb. increments are easier to control. The frame modification makes the chassis stiffer, permits engine relocation and is specifically designed for the do-it-yourselfer and requires no jig welding.



Item	Description
102011	A-Arm Compact- 2X3
102012	A-Arm Front Snout Kit- 2x3 Intermediate
102017	Round Tube Compact
102018	Round Tube Intermediate
181031	Billet Aluminum Rack Clamp
181410	Tie Rod Tube Adaptors
FR1501	'71-'72 Pinto Rack and Pinion
501202	Wilwood H.D. Drag Race Front Brake Kit
501201	Wilwood H.D. Street Brake Kit

Item	Description
181418	Steering Column
181423	Pinto Lower A-Arm (2)
181424	Pinto Upper A-Arm (2)
261910	Pinto Ball Joints (2)
501009	'71-'72 Pinto fabricated Spindles
S5204	Strange Coil Over Shocks & Springs
102016-K	Complete Kit

*ALSTON manufactures a complete line of accessories for these kits.*

# SAVE 10% WHEN YOU BUY A COMPLETE KIT

## UNIVERSAL OR PRO-LINK LADDER BAR FRAME

### KIT INCLUDES:

- 1 5/8" Upper Coil Over Shock Crossmember Pair 2
- X 3 Mandrel Bent Frame Rails
- 2 x 3 Dropped Cross Member
- 2 x 3 Sub Frame Connectors
- Pair 32" Adjustable Ladder Bars With Tabs & Hardware
- 1 5/8" Rear Cross Member
- Bolt-On 4130 Chrome Moly Track Locator With Billet Machined Clevis's
- Adjustable Lower Coil Over Shock Mount Strange Coil Over Shocks
- Fabricated 9" Ford Housing

#102113PKG



SAVE 10% WHEN YOU BUY A COMPLETE KIT.

### OPTIONS AVAILABLE:

- Wilwood Disc Brake Kit Strange 35
- Spline Axles Strange Center Section

Also Available in 1 5/8" Round Tube #102114

## A-ARM FRONT SNOOT

### KIT INCLUDES:

- Billet Aluminum Rack Clamp
- '71-'72 Pinto Rack and Pinion Steering Column
- Pinto Lower A-Arm (2)
- Pinto Upper A-Arm (2)
- Pinto Ball Joints (2)
- '71-'72 Pinto fabricated Spindles
- Strange Coil Over Shocks & Springs Tie Rod Tube Adaptors

#102015PKG



SAVE 10% WHEN YOU BUY A COMPLETE KIT.

### OPTIONS AVAILABLE:

- Wilwood H.D. Drag Race Front Brake Kit
- Wilwood H.D. Street Brake Kit

Also Available in 1 5/8" Round Tube

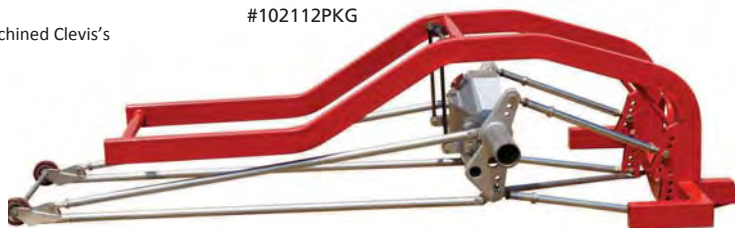
### KIT INCLUDES:

- Pair 2 X 3 Mandrel Bent Frame Rails
- 2 x 3 Dropped Cross Member
- Pair 2 x 3 Sub Frame Connectors
- 1 5/8" Upper Coil Over Shock Cross Member With Tabs & Hardware
- 1 5/8" Rear Cross Member
- Pro Link - 4 Link Kit
- Bolt-on 4130 Track Locator with Billet Machined Clevis's
- Adjustable Lower Coil Over Shock Mount
- Fabricated 9" Ford Housing
- Strange Aluminum Coil Over Shocks
- Aurora Rod End Kit

## PRO-LINK 4-LINK FRAME

Also Available in 1 5/8" Round Tube #102111

#102112PKG



SAVE 10% WHEN YOU BUY A COMPLETE KIT.

### OPTIONS:

- Wilwood Disc Brake Kit Strange 35 spline Axles Strange Center Section

**HEIDTS**  
SUSPENSION SYSTEMS

Order/Tech: 800-841-8188

# FABRICATED REAR END HOUSING

#181016 Please specify width when ordering.

*Designed to fit all popular 9" Ford style differentials. Features 3" axle tubes and internal gussets. Your choice of housing ends Big Ford, Small Ford, GM or Mopar.*



AXLE VENT #351911

GIANT FILL CAP W/BUNG  
#351910

*Available with back brace which substantially increases strength. Standard housing comes in mild steel, or chose the 4130 Chrome Moly version for heavy cars or high horsepower applications.*

## ALSTON'S A-ARM SUSPENSION

### RACE PROVEN 71-71 PINTO

*ALSTON A-ARMS are a bolt-on direct replacement for chassis with stock Pinto suspensions.*



#181424

### UPPER A-ARMS

Specifically designed as a bolt-on replacement for stock Pinto Upper A-Arms used on all **Alston** chassis and front snouts. They are lighter, stronger, and more compact than stock Pinto A-Arms. Screw-in ball joints (purchased separately), and steel bushings are also used for a steadier ride. This compact design adds greatly to available header clearance. Powder coated for a long lasting beautiful finish and to enhance the appearance of your chassis.

### LOWER A-ARMS

These precision Lower A-Arms fit all **Alston** chassis and snouts that use Pinto front suspension. **Alston's** A-Arms have several advantages over the stock Pinto arms. First there lighter, stronger, and uses a more compact screw in ball joint (sold separately). The lower shock mount and control link tabs are already attached. Plus they use steel bushings instead of rubber for a more steadier ride. Powder coated for a long lasting beautiful finish and to enhance the appearance of your chassis.



#181423

### SPINDLES

Based on the race proven 71-72 Pinto. These spindles are jig-built and fitted with caliper brackets to fit popular Wilwood front brake kits. The steering arms are in the stock location and are designed to directly replace the OEM spindles with no modifications. Engineered to withstand the rigors of drag racing. **Alston** spindles are also powder coated to ensure long lasting appearance



#501009



# 4-LINK KITS

## STANDARD PRO-LINK 4-LINK SUSPENSION

Our link tubes are made from 1" O.D. x .156 wall DOM tubing internally threaded right and left. Large wrench flats make adjustment incredibly easy.

#181373



## KIT CAR 4-LINK

The 3/16" thick, double-shear chassis brackets are exceptionally strong. Our triangulated bars deliver extra lateral support, and five mounting holes provide precise instant center adjustment. ALSTON chassis brackets are stamped and tumble-finished. Our 4-link bars are approx. 20" in length, allowing for various instant center adjustments without pinion bind. Adjuster nut is permanently attached for turning link.

*Kit includes housing brackets, chassis brackets, 4-link bars, detailed instructions. (Rod Ends Sold Separately)*

Item	Description
181314	4-link for use in kit cars
181315	4-link for use in sportsman cars
181335	Axle brackets only (4-link) (4)
181343	5 hole front mounting brackets only (4-link) (4)

#181314



## ROD END KIT PRO-LINK 4-LINK

All ALSTON'S Rod end kits are manufactured by Aurora Bearing using the highest quality of precision and craftsmanship for our products.



Item	Description
181352	Pro-Link 4130 Moly

## ROD END KIT 4-LINK – KIT CAR & SPORTSMAN

Item	Description
181317	4130 Moly

## LADDER BARS

#181323



ALSTON'S 32" double adjustable ladder bars let you make precise pinion angle adjustments when your instant center is changed quickly without removing them from the vehicle.

## LADDER BAR RESTRAINT KIT



#181374

## TRACK LOCATORS

FAR STRONGER than our standard Track Locator, this Locator has a unique "BOLT-ON" feature. A special threaded clevis, of our own design, replaces the nut on the bolt that attaches the ladder bar to the rear end and chassis. Left and right hand threaded heim joints allow you to make precise bar adjustments, without the need to remove the locator from the car. The extra smooth operation eliminates any bind from the system while keeping the rear end square in the chassis. Made from 7/8 O.D. X 36", 4130 chrome moly tubing and heavy duty clevis.

Item	Description
181311	Bolt-On Track Locator <i>Use with Pro-Link, Features 5/8" bolts</i>
181312	Bolt-On Track Locator <i>Use on any Kit or Sportsman 4-Link with 3/4" bolts</i>
181371	Bolt-On Track Locator <i>Use with ALSTON Ladder Bars, Features 5/8" clevis.</i>



# MUSTANG BRACES, BARS & ARMS

## UPPER AND LOWER CONTROL ARMS

All of **ALSTON'S** Upper and Lower Control Arms features sleek round tube design that are jig welded for a perfect fit. Genuine Energy Suspension bushings are used exclusively for a long life with low maintenance. Profile milled sway bar mounts are engineered to fit factory or after market sway bars. Heavy duty 3/16" spring mounts ensure no flex even with high spring combinations. Like most of our bolt on products they are powder coated gloss black for a long lasting beautiful finish.

Item	Description
401042	79-04 Mustang Upper Arm
401042	05-06 Mustang Upper Arm
401016	79-04 Mustang Lower Arm



#401042



#401016

## ADJUSTABLE UPPER CONTROL ARMS

Our **ADJUSTBLE** Upper Control Arm features Teflon-Lined rod ends and machined adjusters which allow quick pinion angle adjustment without removing the control arm from the car.

Item	Description
401044	79-04 Mustang Live-Axle



401044

## ADJUSTABLE COIL OVER LOWER SHOCK MOUNT

Many racers feel there is an advantage in being able to adjust rear ride height. Our lower mount makes it possible to move rear coil over suspensions a full 4 1/2" in 1/2" increments. This conversion allows you to modify existing, fixed mounted coil over shock set ups.



#181361

## REMOVABLE TRANSMISSION MOUNT

Transmission maintenance is simplified with this universal, removable cross member. transmission mount fits all OEM **ALSTON'S** transmissions, and can be installed on either round or rectangular frame rails. All brackets and hardware included.



#331016

## TUBULAR DRIVE SHAFT LOOP

Mandrel bent from 4130 chrome moly tubing, our loop is strong, lightweight, and quickly removed. Our computerized mandrel bender creates the tightest possible radius for optimum strength without rippling! Package includes fast pins for easy transmission access.



#331018



## ULTRA LIGHT RACING WINDOWS

### HIGH PERFORMANCE WINDOWS WITH DIAMOND SHIELD COATING

**WHEN ORDERING PLEASE NOTE: HARDTOP OR COUPE  
AND STOCK GLASS OR FIBERGLASS DOOR.**



#### SAFETY

Fast Glass Is far superior in absorbing impact than standard OEM automotive glass.

#### WEIGHT

Fast Glass Is about 75% lighter than stock OEM glass. Making it one of the best *"Bang for the Buck"* deals.

#### DURABILITY

Fast Glass Windows can be removed and replaced easily without the threat of cracking or shattering.

#### CHOICE

Choose between FastGlass Standard or Diamond Shield. Diamond Shield windows utilize a coating that is applied during the manufacturing process. This coating allows the window to retain optical clarity for a much longer period of time. Typically, Diamond Shield Coated windows are used for front and rear windshields.

#### CLARITY

Fast Glass Has excellent optical clarity.



**Order/Tech: 800-841-8188**



# ULTRA LIGHT RACING WINDOWS

YEAR	APPLICATION	STANDARD KIT	COATED KIT	WINDSHIELD	REAR WINDOW	DRIVERS WINDOW	QUARTER WINDOW
71-77	VEGA	801015	801115	801215	801615	801815	802015
62-65	CHEVY II	801016	801116	801216	801616	801816	802016
66-67	CHEVY II	-	801117	801217	801617	801817	802017
67-69	CAMARO/ FIREBIRD	801010	801110	801210	801610	801810	802010
70-74	CAMARO	801011	801111	801211	801611	801811	802011
75-81	CAMARO	801012	801112	801211	801612	801811	802011
82-92	CAMARO	801013	801113	801313	801613	801813	-
93-02	CAMARO	801014	801114	801214	801614	801814	-
64-65	CHEVELLE	801018	801118	801218	801618	801818	802018
66-67	CHEVELLE	801019	801119	801219	801619	801819	802019
68-72	CHEVELLE	801020	801120	801220	801620	801820	802020
68-72	NOVA	801031	801131	801231	801631	801831	802031
55-57	CHEVY	801021	801121	801221	801621	801821	802021
78-83	MALIBU	801022	801122	801222	801622	801822	802022
64-66	MUSTANG FASTBACK	801023	801123	801223	801623	801823	802023
67-68	MUSTANG FASTBACK	801024	801124	801224	801624	801824	802024
79-93	MUSTANG	801025	801125	801225	801625	801825	802025
94-04	MUSTANG	801029	801129	801229	801629	801829	802029
05-09	MUSTANG	801030	801130	801230	801630	801830	802030
64-72	VOLKSWAGEN	801027	801127	801227	801627	801827	802027
70-74	CHALLENGER	801032	801132	801232	801632	801832	802032
68-70	AMX	801033	801133	801233	801633	801833	-
53	STUDEBAKER	801026	801126	801226	801226	801826	-
70-77	MAVERICK	801028	801128	801228	801628	801828	802028
68-72	CHARGER	801040	801140	801240	801640	801840	802040

## DOOR WINDOW FRAME KIT

This kit includes everything needed to fabricate frames for your door windows.

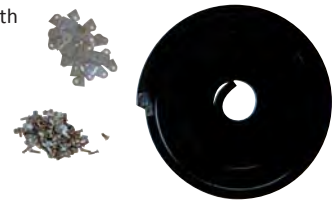
#801008



## WINDSHIELD INSTALLATION KIT

This kit comes complete with gasket material and all hardware.

#801009



## CUSTOM ORDERS? YOU BET!

Send us your patterns or dimensions and we will build it for you.

# INTERIOR KITS

CHASSIS NUMBER	CHASSIS DESCRIPTION	WHEEL WELLS	FRONT INNER FENDERS	FRONT FIRE WALL	DOOR & KICK PANELS	COMPARTMENT FLOOR	TRANS TUNNEL STANDARD	REAR BELLY PAN	REAR FIRE WALL	BETWEEN WHEEL WELLS	COMPARTMENT FLOOR
101810	MS BX AM LB CMP	161012	161912	161910	161914	161915	161917	161919	161921	161926	161937
101811	MS BX AM LB INT	161012	161913	161911	161914	161915	161918	161920	161922	161927	161937
101812	MS BX ST LB CMP	161012	161912	161910	161914	161915	161917	161919	161921	161926	161937
101813	MS BX ST LB INT	161012	161913	161911	161914	161915	161918	161920	161922	161927	161937
101814	AS RF ST LB CMP	161012	161912	161910	161914	161915	161917	161919	161921	161926	161937
101815	AS RF ST LB INT	161012	161913	161911	161914	161915	161918	161920	161922	161027	161037
101828	AS RF ST PL CMP	161024	161912	161910	161914	161915	161928	161931	161933	161935	161937
101830	AS RF ST PL INT	161024	161913	161911	161914	161916	161929	161932	161934	161936	N/A
101834	MS RF AM LB CMP	161012	161912	161910	161914	161915	161917	161919	161921	161926	161937
101835	MS RF AM LB INT	161012	161913	161911	161914	161915	161918	161920	161922	161927	161937
101836	MS RF ST LB CMP	161012	161912	161910	161914	161915	161917	161919	161921	161926	161937
101837	MS RF ST LB INT	161037	161913	161911	161914	161915	161918	161920	161922	161927	161937
101838	AS BX ST LB CMP	161012	161912	161910	161914	161915	161917	161919	161921	161926	161938
101839	AS BX ST LB INT	161012	161913	161911	161914	161915	161918	161920	161922	161927	161938
101841	MS RF AM PL OPL	161024	161912	161910	161914	161916	161930	161931	161933	161935	161938
101842	MS RF ST PL OPL	161024	161912	161910	161914	161916	161930	161931	161933	161935	161938
101843	MS RF AM PL VET	161024	161913	161911	161914	161916	161930	161932	161934	N/A	161938
101844	MS RF ST PL VET	161024	161913	161911	161914	161916	161930	161932	161934	N/A	161938
101845	MS RF AM PL CMP	161024	161912	161910	161914	161916	161928	161931	161933	161935	161937
101846	MS RF ST PL CMP	161024	161912	161910	161914	161916	161928	161931	161933	161935	161937
101847	MS RF AM PL INT	161024	161913	161911	161914	161916	161929	161932	161934	161936	161937
101848	MS RF ST PL INT	161024	161913	161911	161914	161916	161929	161932	161934	161936	161937
103110	UNIVERSAL FRAME	161012	N/A	N/A	161914	N/A	N/A	161920	161922	161939	N/A
161941	2010-2013 CAMARO CHASSIS COMPLETE KIT										

*Appearance, plus lightweight and economical too! Until now your only choice was to pay big time dollars for custom made sheet metal work. The good news is... we have made thousands of these kits for our Pro-Gas and Pro-Link chassis's. So now, you can have custom fit at discounted prices*

These preformed interior panels are designed to be slightly oversized, and give you the opportunity to make the final trim to the exact dimensions of your car. Hand crafted, not punched from a machine - we bead roll every structural panel for extra strength and appearance. All components are aluminum alloy, unless otherwise specified, (also available in 24 gauge sheet metal). and comes with a tuff PVC protective coating to assure that the surface is not accidentally scarred or scratched during handling, it's easily removed after installation. Simply attach with pop rivets or dzus fasteners. The above chart will help you understand the contents of the various that are suited for your application.



# INTERIOR KITS

## TRANSMISSION TUNNEL KIT

### FEATURES:

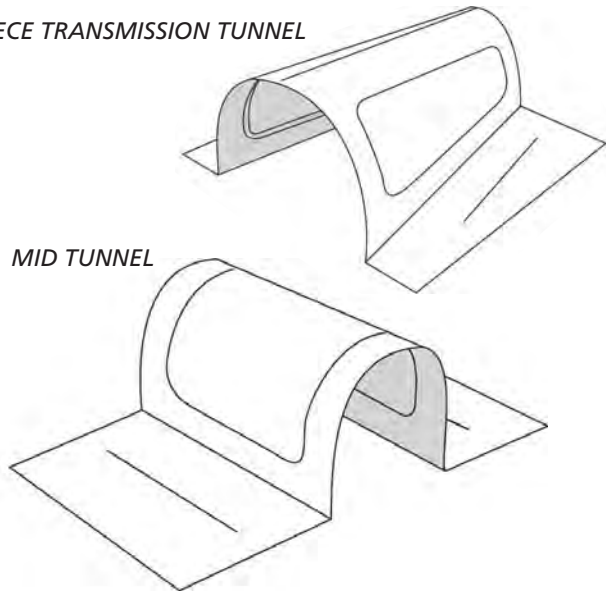
.032" THICK ALUMINUM  
MADE SLIGHTLY OVERSIZED  
TRIM FOR PERFECT FIT  
BEADED FOR EXTRA STRENGTH

### PARTS IN KIT:

- 1 - MID TUNNEL
- 1 - PASSENGER SIDE TRANS TUNNEL
- 1 - DRIVER SIDE TRANS TUNNEL



2 PIECE TRANSMISSION TUNNEL



MID TUNNEL

Item	Description
161917	TRANSMISSION TUNNEL KIT (LB CMP CHASSIS)
161918	TRANSMISSION TUNNEL KIT (LB INT CHASSIS)
161928	TRANSMISSION TUNNEL KIT (PL CMP CHASSIS)

Item	Description
161929	TRANSMISSION TUNNEL KIT (PL INT CHASSIS)
161930	TRANSMISSION TUNNEL KIT (PL OPL CHASSIS)

## REAR BELLY PAN KIT

### FEATURES:

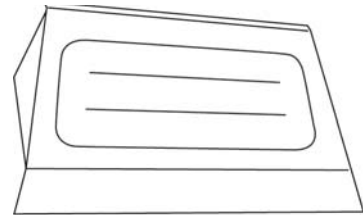
.032" THICK ALUMINUM MADE  
SLIGHTLY OVERSIZED TRIM FOR  
PERFECT FIT BEADED FOR  
EXTRA STRENGTH

### PARTS IN KIT:

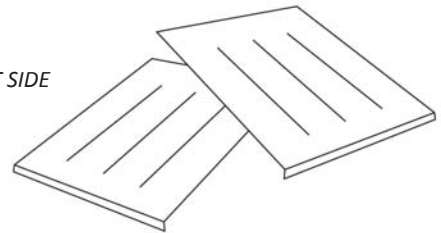
- 1 - CENTER BELLY PAN (*between frame rails behind tubs*)
- 1 - SIDE BELLY PANS (*behind tubs to back of car*)



CENTER  
BELLY PAN



LEFT & RIGHT SIDE  
BELLY PANS



Item	Description
161919	BELLY PAN KIT (LB CMP CHASSIS)
161920	BELLY PAN KIT (LB INT CHASSIS)
161931	BELLY PAN KIT (PL CMP CHASSIS)
161932	BELLY PAN KIT (PL INT CHASSIS)



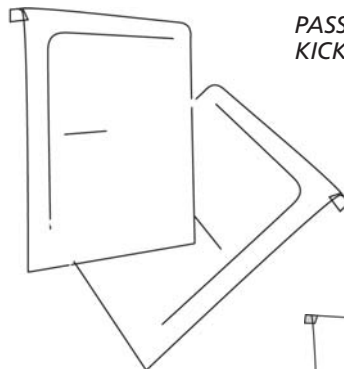
# INTERIOR KITS

## DOOR/KICK PANEL KIT

**FEATURES:**  
 .032" THICK ALUMINUM  
 MADE SLIGHTLY OVERSIZED.  
 TRIM FOR PERFECT FIT.  
 BEADED FOR EXTRA STRENGTH.  
 ROLLED TO LIP FOR NEAT APPEARANCE.

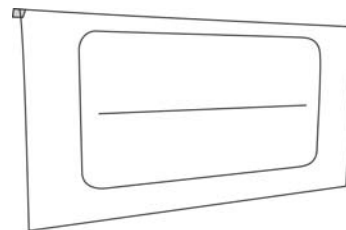
**PARTS IN KIT:**

- 2 - DOOR PANELS
- 1 - PASSENGER SIDE KICK PANEL  
*(in front of wheel tubs)*
- 1 - DRIVER SIDE KICK PANEL  
*(in front of wheel tubs)*



PASSENGER & DRIVER SIDE  
KICK PANELS

DOOR PANEL



Item	Description
161914	DOOR AND KICK PANEL KIT

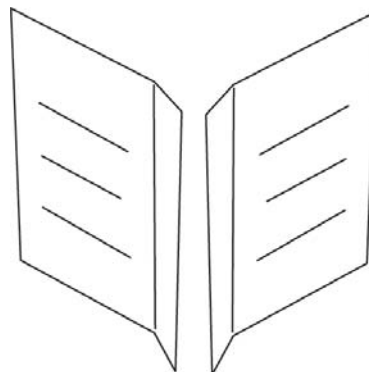
## FLOOR PANEL KIT

**FEATURES:**

.053" THICK ALUMINUM OR 22 GAUGE STEEL  
 MADE SLIGHTLY OVERSIZED  
 TRIM FOR PERFECT FIT  
 BEADED FOR EXTRA STRENGTH  
 ROLLED TOP LIP FOR NEAT APPEARANCE



PANELS IN FRONT OF WHEEL TUBS



PASSENGER SIDE FLOOR PANEL



DRIVER SIDE FLOOR PANEL



Item	Description
161915	ALUMINUM FLOOR KIT (LB CMP/INT CHASSIS)
161916	ALUMINUM FLOOR KIT (PL CMP/INT CHASSIS)
161937	STEEL FLOOR KIT (LB CMP/INT CHASSIS)
161938	STEEL FLOOR KIT (PL CMP/INT CHASSIS)



# INTERIOR KITS

## PRO-LINK CHASSIS

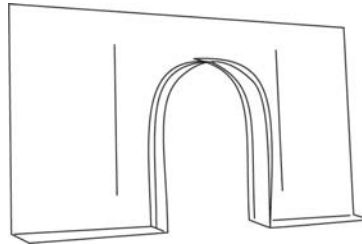
This floor section is made from .032" aluminum and is available for compact or intermediate size chassis. As an added feature the drive shaft floor can be made removable to allow easier access to the rear suspension and rear end housing.

### PARTS IN KIT:

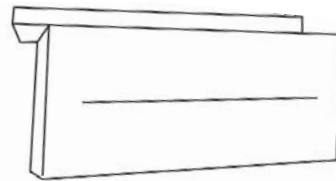
- 1-DRIVE SHAFT FLOOR
- 1-DRIVE SHAFT COVER
- 1-REAR PANEL BETWEEN TUBS (from rear shocks)

Item	Description
161935	FLOOR KIT (PL CMP CHASSIS)
161936	FLOOR KIT ( PL INT CHASSIS)

DRIVE SHAFT COVER



REAR PANNEL BETWEEN TUBS



## FLOOR BETWEEN WHEEL TUBS

PRO-GAS CHASSIS

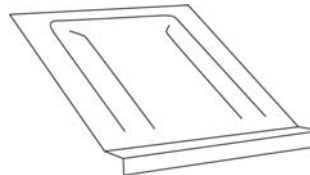
### PARTS IN KIT:

- 1-DRIVE SHAFT COVER
- 1-DRIVE SHAFT FLOOR
- 1-REAR PANEL BETWEEN TUBS

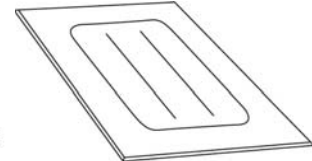


Item	Description
161926	FLOOR KIT (LB CMP CHASSIS)
161927	FLOOR KIT ( LB INT CHASSIS)

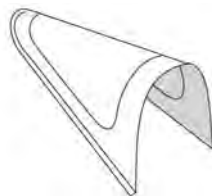
DRIVE SHAFT FLOOR



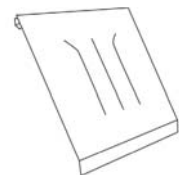
DRIVE SHAFT FLOOR



DRIVE SHAFT COVER



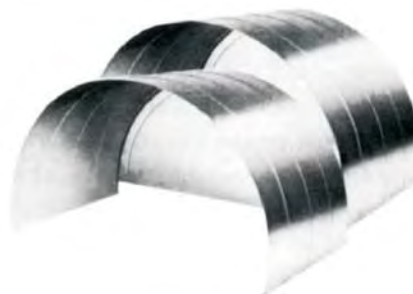
REAR PANEL BETWEEN TUBS



## WHEEL TUBS

Available in your choice of aluminum or steel. Beaded for added strength, these wheel wells features preformed Pittsburgh interlocking seam that makes assembly very simple with a professional appearance.

Item	Description
161010	21"x 38" ALUMINUM
161011	21"x 38" STEEL
161012	24"x 40" ALUMINUM
161013	24"x 40" STEEL
161024	28"x 46" ALUMINUM
162025	28"x 46" STEEL



# INTERIOR KITS

## UNIVERSAL SUB FRAME REAR FLOOR KIT

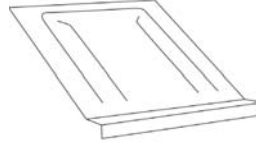
Designed exclusively for use with universal Pro-Street rear sub frame when the OEM steel floor has been removed. Made from .032" aluminum, this kit includes 2 additional panels that fit in front of the wheel tubs. For added convenience the drive shaft floor can be made removable to provide easier access to the rear end housing and rear suspension components.

### PARTS IN KIT:

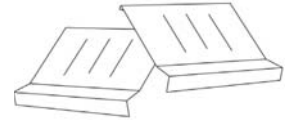
- 1 - DRIVE SHAFT COVER
- 1 - DRIVE SHAFT FLOOR
- 1 - REAR PANEL BETWEEN TUBS
- 2 - PANELS IN FRONT OF TUBS

Made oversized so it can be trimmed to fit.  
Beaded for extra strength

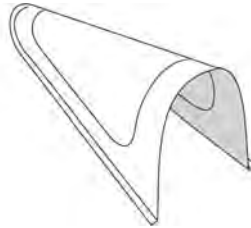
DRIVE SHAFT FLOOR



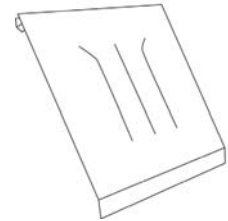
PANELS IN FRONT OF TUBS



DRIVE SHAFT COVER



REAR PANEL BETWEEN TUBS



Item	Description
161939	UNIVERSAL SUB FRAME REAR FLOOR KIT

## UNIVERSAL SUB FRAME REAR BELLY PAN KIT

### FEATURES:

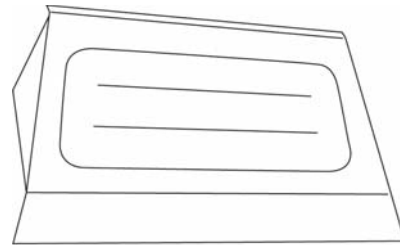
.032" THICK ALUMINUM MADE SLIGHTLY OVERSIZED TRIM FOR PERFECT FIT BEADED FOR EXTRA STRENGTH

### PARTS IN KIT:

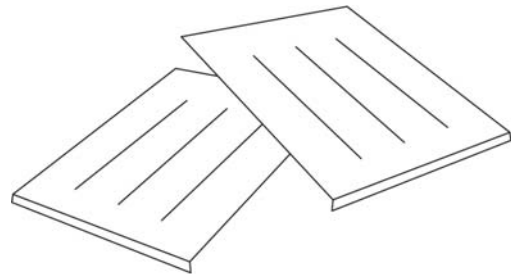
- 1 - CENTER BELLY PAN  
(between frame rails behind tubs) 1
- SIDE BELLY PANS  
(behind tubs to back of car)



CENTER BELLY PAN



LEFT & RIGHT SIDE BELLY PAN



Item	Description
161920	INTERMEDIATE
161919	COMPACT

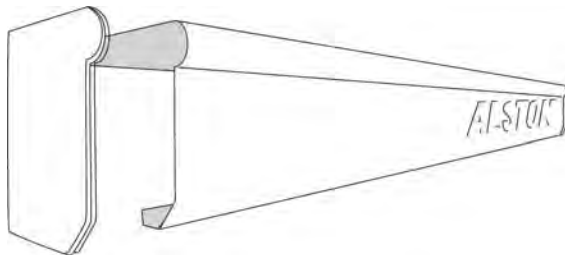




# INTERIOR KITS

## UNIVERSAL ALUMINUM DASH

Made from .032" Aluminum this unique design puts the finishing touch to the interior of any race car. This dash will allow for the installation of gauges up to 3 1/2" diameter. A rolled front edge adds stiffness to the dash while the generous over hang helps shade glare from the instrument faces. Installation is not complicated - simply the window edge and cut the length to fit. Snap the preformed end caps in place, rivet into position and install your gauges. Untrimmed dimensions are 8" deep and 60" wide.



#161940

## FRONT INNER FENDER KIT

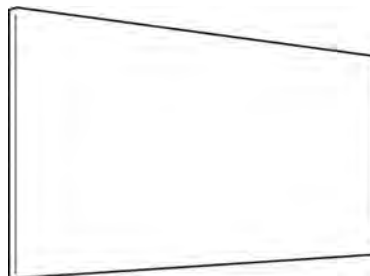
### FEATURES:

.032" THICK ALUMINUM MADE SLIGHTLY OVERSIZED TRIM FOR PERFECT FIT BEADED FOR EXTRA STRENGTH ATTACHES TO FIBERGLASS COMES OFF WITH FRONT END

### PARTS IN KIT:

- 1 - SPLASH PAN TOP PASSENGER SIDE.
- 1 - SPLASH PAN TOP DRIVER SIDE.
- 1 - CENTER SPLASH PAN
- 1 - INNER SPLASH PAN

INNER SPLASH PANEL



CENTER SPLASH PANEL



DRIVER & PASSENGER SIDE INNER SPLASH PANS



Item	Description
161912	COMPACT
161913	INTERMEDIATE

# INTERIOR KITS

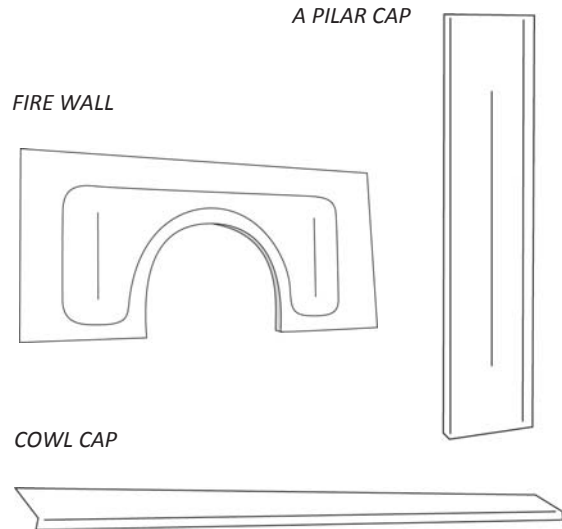
## FRONT FIRE WALL KIT

### FEATURES:

- .050" THICK ALUMINUM
- MADE SLIGHTLY OVERSIZED TRIM FOR PERFECT FIT
- BEADED FOR EXTRA STRENGTH
- HAS FLANGE FOR TRANS TUNNEL

### PARTS IN KIT:

- 1 - FIRE WALL
- 1 - COWL CAP  
*(steel to weld to existing fire wall)*
- 2 - A PILAR CAPS  
*(caps off ends of fire wall to A pillar).*



Item	Description
161910	FRONT FIRE WALL KIT (LB or PL, CMP chassis)
161911	FRONT FIRE WALL KIT (LB or PL, INT chassis)

## REAR FIRE WALL KIT

### FEATURES:

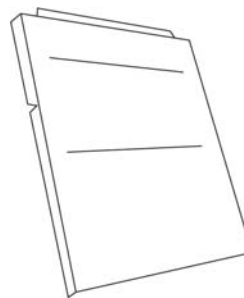
- .032" THICK ALUMINUM
- MADE OVERSIZED TRIM FOR PERFECT FIT
- BEADED FOR EXTRA STRENGTH SEALS OFF DRIVERS COMPARTMENT FROM REAR TRUNK AREA

### PARTS IN KIT:

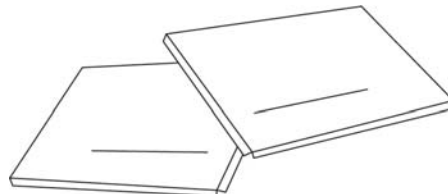
- 1 - DRIVE SIDE REAR FIRE WALL *(above tubs)*
- 1 - PASSENGER SIDE REAR FIRE WALL *(above tubs)*
- 1 - CENTER REAR FIRE WALL  
*(above rails and between tubs).*

Item	Description
161921	REAR FIRE WALL KIT (LB, CMP chassis)
161922	REAR FIRE WALL KIT (LB, INT chassis)
161933	REAR FIRE WALL KIT (PL, CMP chassis)
161934	REAR FIRE WALL KIT (PL, INT chassis)

### CENTER REAR FIRE WALL



### DRIVER & PASSENGER SIDE REAR FIRE WALL



**INDEPENDENT FRONT SUSPENSION.**

Independent suspension can be very simple and very complicated at the same time. Success in making it simple is learning the rules.

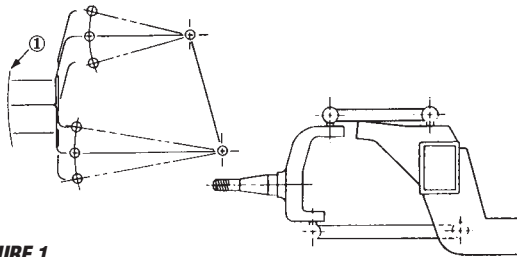
**And it has it's own set of rules.** Important, **Rule#1.** Unlearn everything (almost) you know about steering and suspending a car with a solid axle and 4-link suspension. That would be like trying to play football using baseball rules.

The first thing to relearn is the action of the front axle and spindle during suspension travel. There are three things to control in the front wheel: camber, caster and toe angle.

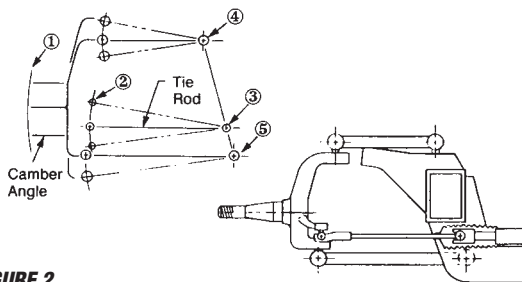
**CAMBER AND CASTER**

In a solid axle the camber is built into the axle and the caster built into the 4-Link design. Both are constant (they don't change during suspension travel). A solid axle moves basically straight up and down therefore, so does the spindle.

On an IFS System, the upper and lower control arms, as well as the spindle and car chassis, form an uneven parallelogram, as viewed from the front (see fig. 1 & 2). The spindle moves up and down in an arc-or radius-which is determined by the length and placement of the two control arms. Their placement also determines the amount of caster and camber change.

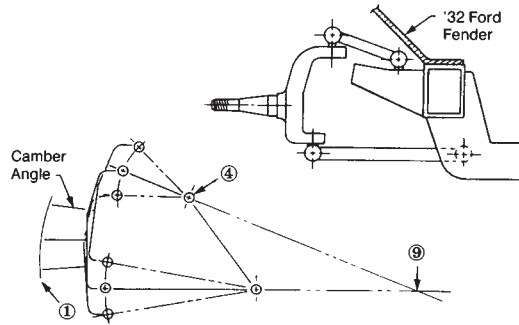


**FIGURE 1**  
This is a correct Mustang II front suspension in a street rod, when the stock Mustang II suspension locations are used. Notice the parallel upper and lower arms. Also notice there is minimal camber change and almost flat radius (1) in the movement of the spindle during suspension travel.



**FIGURE 2**  
Now we have added the stock Mustang II steering rack in the stock Mustang II location using the stock Mustang II tie rod ends. Notice the radius of the rod ends (2) matches the radius of the spindle. Also, more importantly, see that the inner tie rod pivot (3) is IN LINE with the inner pivots (4) & (5) of the upper and lower arms. This is absolutely necessary. Ford Motor Co. did their homework.

Important **Rule #2.** If any of the four pivot points are moved in any direction, for any reasons, the spindle swings in a new, unique arc which is different from the old radius. Usually at the inner pivot of the upper arm on the Mustang suspension is the one to be moved. The control arm is usually shortened and the pivot shaft lowered to clear fenders on some cars (see Fig. #3). As you can see, the spindle will now swing in a new tighter radius. That in itself is not a problem. But, Please read on, as it is about to get real interesting.



**FIGURE 3**  
This is a typical "modified" Mustang II installation in a '32 Ford type car. The first change is to shorten and drop the upper arm pivot (4) to clear the fender. This causes the much sharper radius (1) of the spindle and resulting increased camber change. Also notice that the two arms now intersect at a theoretical point (9). But this alone is not the bad part. The next step will show you why.

**TOE ANGLE**

The paragraphs that follow explain why **HEIDTS®** does not make Mustang Kits for certain cars.

As we mentioned, there are three things to control in the front wheel. Camber and caster we've already covered. The third is the toe, or steering angle at which the wheel is pointed, which determines where your car goes.

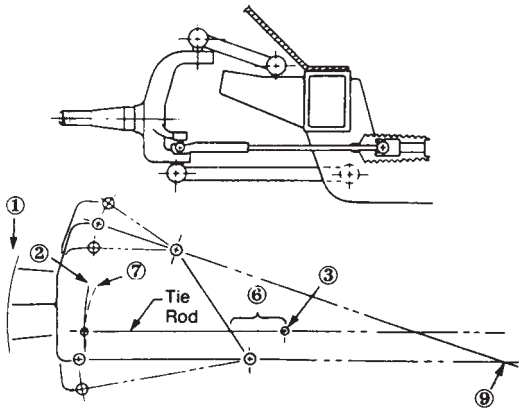
You can see that this means the spindle must always remain in the direction you have pointed no matter where the spindle is in the suspension travel. This is the job of the "Tie Rod". As you can see, the exact length and location of the inner pivot of the tie rod must be very carefully selected so the outer ends of the rod, which are attached to the spindles, swing in a radius which matches the spindle radius exactly. When designing a brand new suspension system on the drawing board this determination is very easy to make, since the tie rods on the rack are actually designed to match the control arm and spindle radius. But on your conversion, this is where the problems start. So this is the next thing to unlearn.

When mounting a steering box in a solid axle installation, motor mounts, etc. usually dictate the location of the box and the pitman arm is modified to align the drag link with the tie rod. Selecting and installing a rack-and-pinion is nowhere near that simple or forgiving.

**When adapting an existing suspension design, such as the Mustang design, it is very important to keep every single mounting location and pivot point, including the rack, in their original designed places.** As you have just seen, the Mustang rack, with a specific tie rod length, was designed by Ford to match the swing radius of the Mustang spindle using stock length Mustang control arms **in the locations which were selected when the Mustang was originally designed.**



If you shorten or lower the inner pivot of the upper arm, the spindle will now swing in a new, different radius which no longer matches the current tie rod radius. If you raise or lower the rack location, or change the tie rod length for any reason by using a longer tie rod end, the tie rod will swing in a new radius which does not match the current swing radius of the spindle (see Fig. #4).



**FIGURE 4**

...it's all over by now. The other common modification/mistake is to widen the crossmember and use a long tie rod end. Ugh, as you can see, by adding the longer (incorrect) tie rod end, the inner pivot of the tie rod (3) now has been shifted way out of line by the dimension (6). Disaster! The flatter radius of the outer tie rod end (2) no longer matches the sharper spindle steering arm radius (7). This causes the spindle steering arm to follow the incorrect radius (2) and change steering angle, or "steer" as the suspension travels up and down over "bumps": more commonly known as "Bumpsteer". You can also see that the projected line from the tie rod does not intersect the intersection point (9) of the control arms. It should. This is why the only Mustang II system works correctly is the way Ford designed it, using all stock Mustang II parts, in the stock Mustang II locations.

## EXPLAINING BUMPSTEER

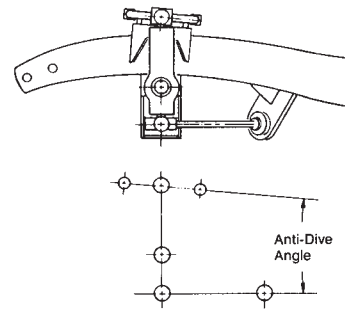
The bottom line of all this radius explanation stuff is this: Since the tie rod ends attach to the spindle steering arm, the tie rod controls the steering angle of the front wheels. If your car goes over a "bump" the spindle goes up and down in its swing radius, determined by the upper and lower arms (remember?). If the tie rod swings in a different radius than the spindle during this suspension travel; it will push or pull on the steering arm of the spindle, changing the direction of the front wheel, "steering" the car. And that is how the term and the monster "BUMP-STEER" were created, where 95% of the problems with incorrect suspension design are found. It is from people not really understanding **this most important relationship between the tie rod length** (not the overall rack length) **and the spindle swing radius**. They feel that if they are able somehow with enough modifications to the parts, to "physically assemble all the parts" that it must be OK. Then they pull down the driveway, over that first curb and low and behold: BUMPSTEER. When you drive a car with BUMPSTEER, the car tends to wander or hop around as you drive down the road over bumps and dips. You have to constantly steer the car to keep it in the lane. Not what you would call an enjoyable ride.

## BUILT-IN ANTI-DIVE

Anti dive is another characteristic required in an independent front suspension system. Anti-Dive helps prevent the car from "nose diving" under hard braking conditions, hence the name. It is something which is found in every factory car manufactured, including the Mustang and Pinto, visible in the suspension design in the upper control arm. It is mounted on an angle, with the FRONT pivot higher than the rear, not level (see fig. #5).

**FIGURE 5**

This is the side view of a correct Mustang IFS kit. Note the angle of the upper control arm, that is higher in front. This angle, through a lot of geometric forces in the spindle when braking, generates a lifting force on the frame at the inner A-arm mounts. This is the same angle as the Pinto, which gives the same amount of anti-dive force as the Pinto. Simply put, factory designs work the way they are supposed to in every respect, so why throw all their engineering and testing out the window?



This is the only way to incorporate this important feature, no matter what else you have heard. If you cannot see the angle in the upper arm, then the anti-dive is simply not there. Period.

The actual description of how anti-dive works involves extensive vector force diagrams and is much too lengthy to describe here. Let's just trust the big three auto manufacturers on this one, because they all use it. The Pinto uses a 3° angle for their anti-dive in the upper arm. It may look funny only because you are not used to seeing it on a street rod. Look at your family car. Do things look more normal now?

Don't bother looking for it on somebody else's street rod, especially one with other Mustang kits on it. They don't always know why the upper arms are "crooked" and fix(?) them. But how funny would your car look with the bottom of the grille ground away from bumping the street?

Now for the real point of this whole technical explanation. If you drive a Mustang or Pinto, you know that they don't bumpsteer. If you drive a car using a **HEIDTS®** Mustang conversion kit you will happily find that it doesn't bumpsteer either. Why? Because we don't give you longer tie rod ends which would MISMATCH the tie rod length and it's swing radius with the spindle radius. Because we do not alter the track width which would require longer tie rod ends. Because we don't move the location of the upper control arm pivot or shorten the upper arm (to clear fenders-that is why we limit our applications) which would change the spindle swing radius.

**Because HEIDTS® duplicates the design of the Mustang suspension system as Ford Motor Company designed it, you know it will work just as smoothly and effortlessly as it does in the Mustang, which is something no one else can claim.** Study the diagrams and you will see for yourself why **HEIDTS®** manufactures the finest Mustang Conversion Kit available. The only one which will truly make your car a pleasure to drive. The **ONLY ONE** that **REALLY WORKS!**

Now that you have examined this technical book, wouldn't you rather purchase one of the most important parts of your car-the front suspension and steering system-from someone who genuinely knows and is able to tell and show you how and why it is supposed to work correctly?

It is important to us that you understand why we build the kits the way we do and have become the leader in Mustang front end conversion kits.

### FOR MORE INFORMATION

For more technical information and even more detailed explanation of all the facts presented here, we recommend these books.

### CHEVROLET POWER

Fifth edition  
Published in 1984 by  
General Motors

### ADVANCED RACE CAR SUSPENSION DEVELOPMENT

By Steve Smith  
Published By Steve Smith  
Autosports Publication



### TAP DRILL SIZES

Tap Size	Threads Per In.	Drill Size	Tap Size	Threads Per In.	Drill Size
1/4	20	#7	1/4	28	#3
5/16	18	F	5/16	24	I
3/8	16	5/16	3/8	24	Q
7/16	14	U	7/16	20	25/64
1/2	13	27/64	1/2	20	29/64
9/16	12	31/64	9/16	18	33/64
5/8	11	17/32	5/8	18	37/64
11/16	11	19/32	11/16	16	5/8
3/4	10	21/32	3/4	16	11/16
13/16	10	23/32	7/8	14	13/16
7/8	9	49/64	1	14	15/16
15/16	9	53/64			
1	8	7/8			

### TORQUE SPECIFICATIONS

Normal Torque for Tightening Stud Nuts and Bolts  
Stud or Bolt Tightening Torque

DIAMETER	IN. LBS	FT. LBS
1/4	55-85	4.5-7
5/16	110-165	9-14
3/8	190-285	16-24
7/16	295-445	25-37
1/2	450-680	38-57
9/16	640-970	53-81
5/8	880-1300	73-110

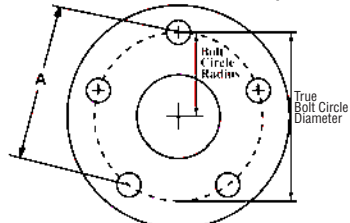
### ENGINE SIZE

Engine size is measured by piston displacement. This is the total volume inches "swept" by all cylinders of the engine.

To determine the cubic inch displacement of an engine.

$$CID = \text{Bore} \times \text{Bore} \times \text{Stroke} \times \text{Number of Cylinders} \times 0.7854$$

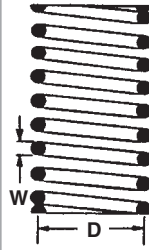
### Bolt Pattern Dimensions for 5-lug Wheels



If Measurement A Is:	Then your Bolt Circle Is:
4 1/4 inches	4 1/2 inches
4 1/2 inches	4 3/4 inches
4 3/4 inches	5 inches
5 1/4 inches	5 1/2 inches

### STIFFNESS OF COIL SPRING

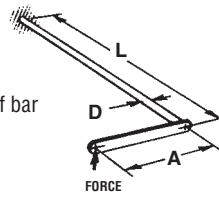
$$K = \frac{W^4 G}{8ND^3}$$



K-Spring rate (lb/in)  
W-Diameter of spring wire (in.)  
G-12,000,000 (for steel springs)  
N-Number of "free" coils + 0.5  
D- Diameter of spring coil (in.)  
Note how sensitive the stiffness of the spring is to the diameter of the spring wire.

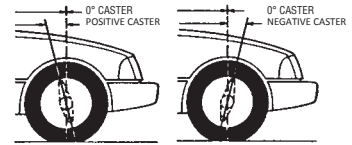
### STIFFNESS OF TORSION BAR

$$K = 1,178,000 \frac{D^4}{LA^2}$$

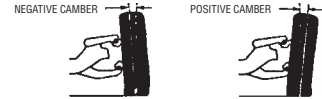


K - Spring rate (lb/in.)  
D - Diameter of bar (in.)  
L - Length of bar (in.)  
A - Length of lever arm (in.)

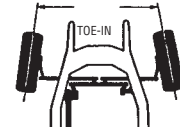
### WHEEL ALIGNMENT



**CASTER** – the number of degrees of forward or backward tilt of the spindle at the top. Forward tilt of the spindle is negative caster. Backward tilt of the spindle at the top from true vertical is positive caster.



**CAMBER** – The number of degrees the top of the wheel is tilted inward or outward from true vertical. Inward tilt at the top of the wheel is negative camber. Outward tilt is positive camber.



**TOE-IN** – The distance in inches the leading edge of the front tires are closer than the trailing edge.

### SPEED CALCULATION

Many high-performance vehicles are capable of higher speed than their speedometer can register. If the vehicle is equipped with a tachometer, its speed can be estimated with the following formula.

$$MPH = \frac{\text{Overall Tire Diameter} \times \text{Achieved Engine RPM}}{\text{Differential Ratio} \times \text{Achieved Top Gear Ratio} \times 336}$$

### HANDY FORMULAS

Circumference of a circle: Multiply the diameter by 3.1416  
Area of a circle: Multiply the diameter by itself and then by .7854  
Volume of a cylinder: Find the area of the end then multiply by length  
Area of the surface of a sphere: Multiply the diameter by itself and then by 3.1416  
Volume of sphere: Multiply the diameter by itself and multiply this product by the diameter again. Then multiply this product (diameter cubed) by .5236  
Area of a triangle: Multiply the base by the height and divide by 2.

### CALCULATING PISTON DISPLACEMENT

The area of head of the piston in square inches, times the number of inches in the stroke, times the number of cylinders, is the engine displacement in cubic inches. The formula is  $d^2 \times .7854 \times L \times N = \text{Displacement in Cubic Inches}$ . N is the number of cylinders.

# “PRO TOURING”

## EASY TO INSTALL!



Here is how the **HEIDTS PRO-G® Subframe** installs on one of our shop cars. This bolt-in install takes little time and provides fantastic “Riding on Rails” performance. We completed the car after installing a GM “383” crate, 5sp Tremec transmission, 13” Wilwood disc brakes, NT01 Tires by NITTO and 18” x 9” Foose Rims. Look for this car at Autocross events near you as **HEIDTS®** proves you can drive it to the event - race it - then drive it home!



1. **Unbolt and roll out your old front subframe.**



2. **The new HEIDTS® Front Subframe and only four bolts, completes the installation to the body.**



3. **HEIDTS® 2” Drop Spindle and Upper and Lower Arms mount to HEIDTS® subframe.**



4. **HEIDTS® Front Subframe with Subframe Connectors joins to HEIDTS® Rear 4-Link Kit.**



### **BOLT A HEIDTS PRO-G® ON YOUR CAMARO/FIREBIRD OR NOVA**

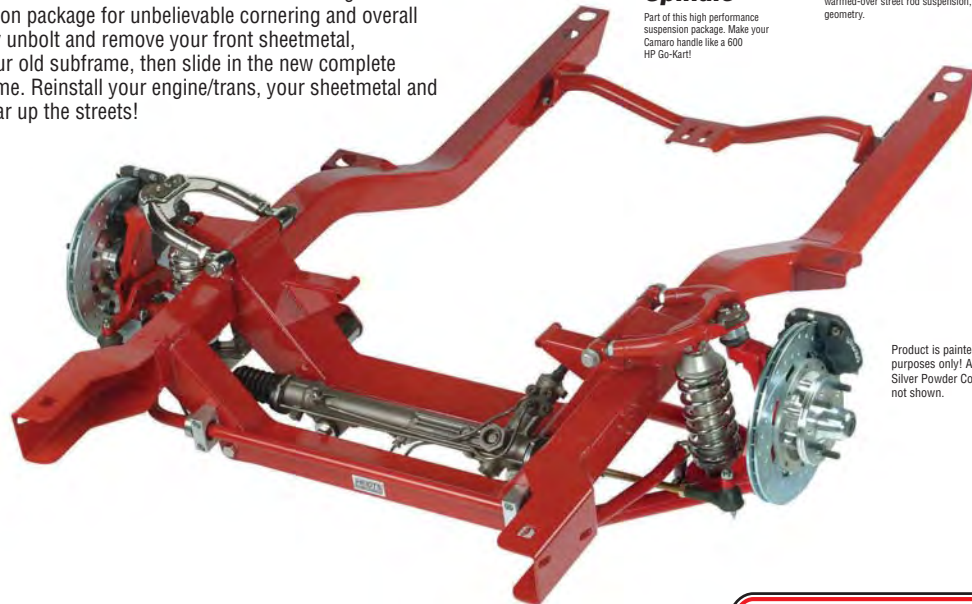
**HEIDTS®** now offers their bolt on front subframe. Featuring their new Pro-G® suspension package for unbelievable cornering and overall handling. Simply unbolt and remove your front sheetmetal, engine/trans, your old subframe, then slide in the new complete **HEIDTS®** Subframe. Reinstall your engine/trans, your sheetmetal and you are set to tear up the streets!

#### **HEIDTS PRO-G® 2” Dropped Spindle**

Part of this high performance suspension package. Make your Camaro handle like a 600 HP Go-Kart!

#### **HEIDTS PRO-G® Suspension**

True High Performance purpose designed suspension. Not warmed-over street rod suspension, but true race car designed geometry.



Product is painted for catalog purposes only! All kits ship with Silver Powder Coated Springs - not shown.



**Order/Tech: 800-841-8188**



# “SMOOTH RIDE!”

## INSTALLING A HEIDTS® FRONT SUSPENSION IN A '35-'40 CHASSIS

Reprinted By Permission From Buckaroo Communications - Photography: Jeff Tann Words: Jeff Tann

We were talking to fellow street rodder Bob O'Bryant the other day and he told us that he just purchased a '40 coupe that he knew about since the early '60s. The car changed hands a few times, but none of the owners did anything with it. Since the '40 spent most of its time garaged, the body was straight and the chassis was in great condition. The minute the car was on the market, O'Bryant jumped at the chance to buy it.

We asked him what his plans were and he replied, “The usual.” In the old days, that would have been a dropped front axle and a hot Flathead, but today it's quite a different story. “The usual” is actually an independent front suspension with a parallel-leaf spring rear suspension and a small-block Chevy engine backed by a Turbo 350 transmission. That's the econo approach.

O'Bryant said he ordered a **HEIDTS®** front suspension because he was happy with the one under his Model A Ford. We asked him if we could photograph the installation and he was more than happy to let us do a step-by-step story. The front and rear suspension system is exactly what we have on a '40 coupe, so we told him that he would be pleased with his decision.

Ford used the same chassis from 1935 to 1940 on passenger cars and until 1941 on pickup trucks, so the installation is universal for anyone with a car that falls into that category. The install is pretty straightforward if you can follow directions, but it does require welding skill and a few special tools. You will need a MIG welder, 5-inch hand

grinder, large 1/2-inch-chuck drill motor, large hand grinder, tape measure and a variety of normal hand tools. The installation took about a day and a half to finish and it was fairly easy to accomplish.

O'Bryant knew that the suspension would be almost impossible to see under the '40, so he ordered a kit that could be painted or powdercoated. Chromeplating or polished stainless would never be seen. He also ordered the kit with GM-style front brakes because he is familiar with how well they work.

If you have been planning an independent front suspension conversion on your Ford, this story will show you how it's done. The body has been removed from the frame and it was sandblasted, making the conversion clean and easy, but if you have a running car, it could be done by removing the front clip and engine. SRB

*The HEIDTS® independent front suspension came with the special crossmember, upper and lower A-arms, a power rack-and-pinion steering unit with ball joints, coilover shocks, spindles, brackets, calipers, rotors and all of the hardware needed to finish the installation. When you consider what you get, the price for this kit is very reasonable.*



1) A heavy-wall-thickness square tube was tack-welded to the chassis to hold it in place when the stock crossmember is removed.



2) Using a 3/8-inch drill, the rivets were drilled to remove the shanks.



3) The crossmember was easy to remove when it was moved back to the wider part of the frame. Since these crossmembers are worth money to nostalgia rodders, owner Bob O'Bryant wanted to keep it in good condition. The radiator mounts are still attached to the crossmember and will have to be removed and used after the new front suspension is installed.



4 According to the instructions, the centerline for the HEIDTS® suspension will be 1/2 inch back from the straight-axle centerline.



5) The HEIDTS® centerline was drawn on top of the frame to make it easy to spot.



6) O'Bryant decided that it would be better to use a pair of hand clamps to secure the boxing plate before the welding was done. He started by tack-welding the section to the frame at the front and rear.



**7)** Here's what the framerail looked like after it was boxed. This strengthens the frame at the point where the crossmember will be installed. Without this, the frame could tear from stress over time.



**8)** The crossmember was installed and it was a tight fit. A few hammer whacks were necessary to get the centerlines to match up.



**9)** Here's the centerline on the frame lined up with the centerline on the crossmember.



**10)** After all of the measurements were made and the crossmember was located correctly, it was tack-welded to the frame.



**11)** The upper A-arm mount or tower had to be installed next. It was placed on the frame and extends upward from the lower crossmember.



**12)** After the towers lined up perfectly, they were tack-welded to the frame. All of the measurements were made again to be certain they were correct. When O'Bryant was satisfied, the towers and crossmember were finish-welded to the frame.



**13)** The Swaybar block was bolted to the crossmember on the bottom, and when it was in place, the upper bolt hole was drilled and tapped. Doing it this way ensures that the bolt holes will line up perfectly.



**14)** Bolting the coilover shock to the upper tower started the installation. At this point the bolt was finger-tight just in case it would have to be removed.



**15)** The lower A-arm was installed using the long bolt supplied in the kit. Washers are supplied to rest against the urethane bushings.



**16)** The coilover shock was connected to the lower A-arm. This is a long bolt because it is also used to secure the Swaybar connector. The bolt is installed from the front and O'Bryant made sure the Swaybar connector was installed first.



**17)** The spindle was connected to the lower A-arm. The lower ball joint is long, so spacers are used to make sure the castle nut aligns with the cotter keyhole.



**18)** Using the other long bolt supplied in the kit, the upper A-arm was installed. This connection also uses the large washers supplied in the kit. The upper bolt is secured with a Nylok locknut.





19) Now the upper A-arm can be connected to the spindle. HEIDTS® recommended using one of its narrow front suspension kits to keep the tires inside the fenderwell so the tires don't hit on turns.



23) After all the front suspension parts are installed, the bolts can be tightened. The upper A-arm bolts were secured with a pair of 15/16-inch wrenches.



25) Before the rack-and-pinion can be installed, you have to install the bolts with a pair of spacers and washers.



20) The caliper bracket is designed with one bolt on the top traveling upward into the spindle and another bolt on the bottom with a bolt that travels sideways into the spindle.



24) The lower A-arm bolt and Nylok locknut was secured with a pair of 15/16-inch wrenches.



26) The rack-and-pinion unit was reinstalled and then it was tightened with a pair of 15/16-inch wrenches.



21) The rotor was installed on the spindle and then the small spindle bearing was installed. It was also packed with high-heat disc-brake bearing grease.



22) After the rotor was installed, O'Bryant tightened the Allen bolts with a 3/8-inch Allen wrench. At this time, you should make sure that the rotors are centered between the calipers.



27) The chassis is finished and the HEIDTS® suspension looks great and works terrific. The '40 will have positive power steering, should handle like a sports car and will stop quickly with the large brakes. The best part is this kit is priced right.



Reprinted By Permission From  
Buckaroo Communications



## QUESTIONS & ANSWERS

**Q. Are independent suspension kits hard to install?**

**A.** No, not if you purchase the correct type. All of HEIDTS® kits are designed to fit specific model cars exactly. You only need to know the type of car you have, not the frame dimensions.

**Q. Do the HEIDTS® Kits work as good as a factory car?**

**A.** Yes, because HEIDTS® does not alter the factory designs. They recognize the fact that the factory spent millions of dollars developing their designs and they are not improved by moving pivot points or changing tie rod ends or other components.

**Q. How do the HEIDTS® conversion kits compare to the front subframe swaps?**

**A.** A properly designed suspension conversion kit will ride and handle every bit as good as a subframe swap. The difference in the conversion kit is about one tenth the amount of work. When you cut off your frame rails for a subframe swap, you no longer have a place to mount the fenders or radiator. Besides all that, you have to relocate the motor mounts and often times narrow the subframe, along with the steering linkage. On quality conversion kit, be it a Mustang type or a tubular control arm type, you simply install the crossmember, which should be designed for your particular frame, bolt on the suspension components, then bolt your car back together. The difference is a job that took only a couple of days rather than two or three weeks.

**Q. Do you keep your kits in stock or do I need to supply dimensions of my frame so you can build one when I order?**

**A.** The designs of the cars for which we make conversion kits has not changed since those cars were built 40-50 years ago. So, there is no reason to special order a standard kit. All our products are built for stock and are on the shelf ready for shipment, since we already know what your frame looks like, You need only to tell us what type of car you have.

**Q. How do you ship your products?**

**A.** All our products except truck freight items, are packaged to ship U.P.S. This is the most economical method. Of course, if you are in a hurry, next day and second day service is available.

## HEIDTS® ORDERING, SHIPPING & WARRANTY TERMS.

**Payment:** U.P.S. orders when paid by Mastercard, Visa, American Express or Discover will be shipped prepaid and the shipping costs will be included on the invoice.

**Shipping:** We will ship by the most economical carrier. Most orders in the Continental U.S. are shipped U.P.S.

**Manufacturer's Rights Retained:** HEIDTS® reserves the right to make changes in design or to make additions to or improvements upon any of its products at any time without incurring any obligation whatsoever to install the same or improve upon products previously manufactured.

**Claims for Damage or Shortage:** Claims for damaged or lost merchandise are to be made to freight carrier. If you receive a damaged package or a package that looks like it has been tampered with, make a written note of this to the freight carrier when you sign for receiving the package. A verbal note to the driver is not sufficient. Carefully open and be sure to save the damaged container as visible proof, this is the first thing they will ask to see! Notify the local office of the freight carrier as soon as possible (within 48 hours). Claims for shortage of merchandise (other than lost items) to be made to us within five days of receipt of order.

**Return Merchandise:** All sale and final merchandise may be returned only with consent of HEIDTS® Any merchandise accepted for return is subject to a 15% restocking charge. All goods approved for return must be shipped freight prepaid, as the Receiving Department is not authorized to accept collect shipments. Products that have been used or altered in any way cannot be returned. No returns after 30 days.

**Guarantee and Liability:** Merchandise is guaranteed free from defects in material and workmanship. For one year we will repair or replace, at our option, any product found to be defective subject to our inspection and approval. HEIDTS® will not be liable for personal or property damage caused by use or mis-use of any product we manufacture or sell. User shall determine the suitability of the product for its intended use, and the user shall assume all responsibility and risk in connection therewith.

## IMPORTANT LEGAL INFORMATION

This Warranty sets forth our maximum liability for our products. We shall not be liable for special, indirect, consequential, or incidental damages. Your sole and exclusive remedy with respect to any and all losses or damages resulting from any cause whatsoever shall be as specified herein. We make no other warranty or guarantee, either express or implied, including implied warranties of merchantability and fitness for a particular purpose to the original purchaser or to any subsequent user of the product, except as expressly contained herein. In the event state law precludes exclusion or limitation of implied warranties, the duration of any such warranties shall be no longer than, and the time and manner of presenting any claim thereon shall be the same as, that provided in the express warranty stated herein. No distributor, dealer or representative of HEIDTS® has the authority to change, modify or expand this warranty. This warranty extends to the original purchaser (original purchaser means the distributor/purchaser and the initial owner of the vehicle where the product is initially installed) and is not transferable. The original purchaser of this product acknowledges that they have read this warranty, understand it and are bound by its terms and agrees to provide this warranty to the original owner of the vehicle into which the product is installed. Should state or provincial law preclude no transferability, then the warranty period is effective 30 days from the date of initial purchase. ©2014 HEIDTS®

**Prices subject to change without notice. All photos Colorized for catalog purposes only!**



©2017 HEIDTS® – No part of this catalog may be reproduced without our written permission.

**Order/Tech: 800-841-8188**

**HEIDTS®**  
**SUSPENSION SYSTEMS**

