

SNAPTAIN

# P30

249g

■ FOLDABLE GPS DRONE

FOR AGES  
**14+**

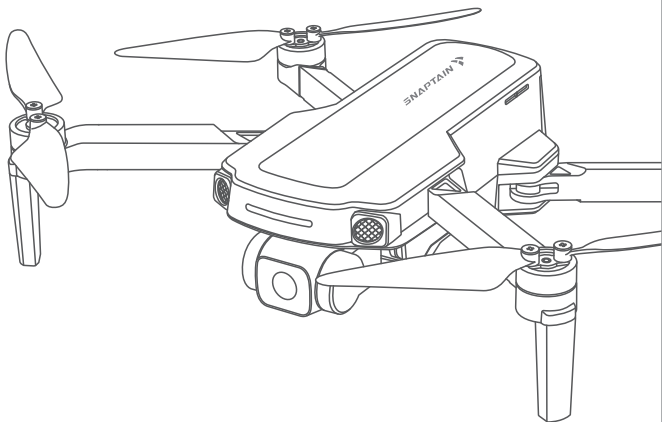

## USER MANUAL

Please read this manual carefully before flying and keep it for future use.

V1.02

- For your safety, please follow the rules and safety guidelines whether you're a beginner or an expert at flying drones.
- According to the relevant laws and regulations in US, all drones must be registered, except those that weigh 0.55 pounds or less (less than 250 grams) and are flown exclusively under the Exception for Recreational Flyers. Please log in to the website of <https://faadronezone-access.faa.gov/#/> to complete the registration. The maximum take-off weight will be more than 249g if the drone is used with the Intelligent Flight Battery. Make sure to observe local laws and regulations about the take-off weight. If the buyer does not register timely, SNAPTAIN will not be responsible for any losses, penalties and injuries caused by illegal flights.
- To meet the electromagnetic requirements of aviation on the radio station, it is forbidden to fly drones within 6.21 miles(10km) on both sides of the runway centerline, or within 12.43 miles(20km) of both ends of the runway. It is also prohibited to fly a drone on the route of an airline. In the area that is prohibited by the relevant authority or department of your country, stop using all flying models and unmanned quadrotors.
- Please download the B4UFLY App from Google Play or App Store, which provides real-time information about airspace restrictions and other flying requirements based on your GPS location.

# ENGLISH



**AIM HIGH FLY HIGH**

Thank you for choosing our product and putting your trust in us.

Contact us via email at

**[support@snaptain.com](mailto:support@snaptain.com)**

if you have questions or concerns about the product.

We hope our products will make flying a whole new experience for you!

Please read the manual carefully for the best use of this product.

# CONTENTS

IMPORTANT SAFETY PRECAUTIONS .....	01
FLY SAFELY .....	02
WHAT'S INCLUDED .....	04
DRONE .....	05
REMOTE .....	07
CHARGE .....	10
FLIGHT OPERATION .....	12
SNAPTAIN FLY APP INTRODUCTION .....	18
SMART OPEARTION FUNCTIONS OF THE APP .....	23
PHOTO AND VIDEO .....	27
LED INDICATORS DESCRIPTION .....	28
SPECIFICATIONS .....	29
OTHER PARAMETERS .....	30
TROUBLESHOOTING .....	31

# IMPORTANT SAFETY PRECAUTIONS

---

This drone can pose a danger when in use. When flying, make sure that you keep it away from other people. Incorrect installation, poor conditions, or unfamiliar users may damage the drone, cause injury, or lead to an unexpected accident. Make sure that you pay close attention to flying safety, and learn how to identify more dangerous conditions that may cause an accident due to your negligence.

## 1. Avoid crowds and structures

There may be uncertainty about the drone's flight state and speed while in flight, which can cause potential danger. When flying, keep your drone far away from crowds, buildings, trees, structures, high-voltage wires, etc. Flying should also be avoided in adverse weather conditions such as rain, storms, and high winds to ensure the safety of the user, spectators, and property around the site.

## 2. Avoid moist environments

Drones are made up of a variety of precision electronic and mechanical components. As a result, please make sure that moisture and water do not enter the drone. This can prevent mechanical or electronic parts from malfunctioning and thus causing an accident.

## 3. Only use the included parts for intended use

For any maintenance or repairs, please use the original parts made by SNAPTAIN. You should only use and operate the product in accordance with its permitted functions. The warranty will be voided if you apply unapproved parts. Use only within the scope of your local laws and regulations, and NOT for illegal purposes.

#### 4. Avoid controlling the drone alone

It may be difficult for beginners to operate this drone at the beginning. Please avoid flying the drone alone. When possible, operate this drone under the guidance of an experienced pilot.

#### 5. Fly safely

Fly this drone in accordance with your state and flying skill. There is an increased probability of accidents if a person is fatigued, has a poor mental state, or operates incorrectly.

#### 6. Stay away from the rotating parts

You should keep the drone away from you and any surrounding persons or objects when flying it at high speed.

#### 7. Keep it away from heat sources

Drones are made of metal, fiber, plastic, electronics, etc. Avoid prolonged exposure to direct sunlight and keep it away from any heat source. Excessive heat exposure can cause distortion and damage.

## FLY SAFELY

---

### FPV transmission requirements:

- \*Make sure to fly the drone in an open area without any interference or obstacles.
- \*Do not fly against the wind.

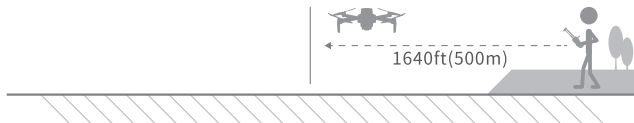



+



+



+



Fly in Open  
Areas

Strong GPS  
Signal

Maintain Line  
of Sight

Maximum flight  
altitude height is  
about 400ft(120m)



Avoid flying over or near obstacles, crowds, high-voltage power lines, trees, airports, or water areas.

DO NOT fly near strong electromagnetic sources such as power lines and base stations as they may affect the onboard compass.



DO NOT use the drone in adverse weather conditions such as rain, snow, fog, and wind speeds exceeding 5 m/s or 12 mph.

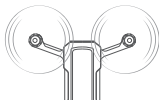

Stay away from the rotating  
propellers and motors



No Fly Zone



For your safety and that of those people around you, it's important to understand basic flight guidelines. Before flying, make sure you read the safety precautions.

# WHAT'S INCLUDED



Drone x1



Remote x1



Battery x1

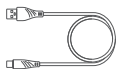

USB Charging Cable x1



Screwdriver x1



Spare Propellers  
Ax4 Bx4



Control Stick Part x 2 Pairs  
(One Pair in the Remote  
and Another in the Box)



Screws



Carrying Bag



User Manual x1



Quick Guide x1



# DRONE

## 1. Know Your Drone

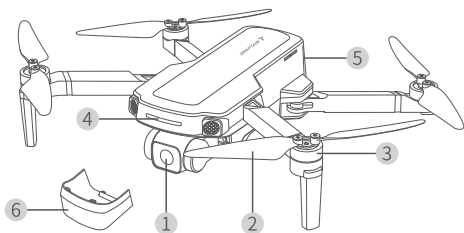

- |             |                       |
|-------------|-----------------------|
| ① Camera    | ④ Front LED Indicator |
| ② Propeller | ⑤ Battery             |
| ③ Motor     | ⑥ Camera Cover        |

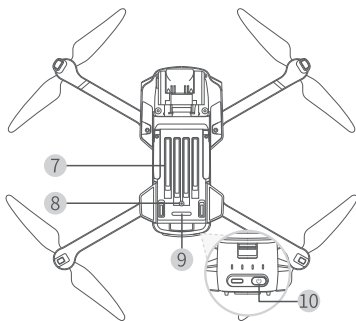

- |                       |                      |
|-----------------------|----------------------|
| ⑦ Memory Card Slot    | ⑨ Rear LED Indicator |
| ⑧ Optical Flow Sensor | ⑩ On/Off Button      |

\*Please insert a memory card(not included) into the drone. This drone accepts a card with capacity up to 128GB. FAT32 or exFAT format is required.

## 2. Replace the Propeller(Optional)

The marks on the propellers (A/B) should match the marks on the drone arms when you replace the propellers.

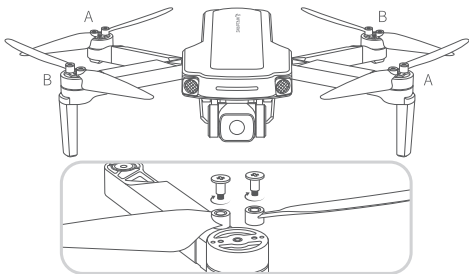

A propellers: Starting with letter A, like A1, A2, etc.



B propellers: Starting with letter B, like B1, B2, etc.

## 3. Drone's Battery

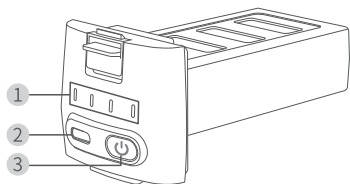

① Battery Power Indicators

② Type-C Charging Port

③ On/Off Button

Low — Battery Power — Full



- Press and hold the **On/Off Button** for 3 seconds to power on the battery and the drone; press and hold this button again for 3 seconds to power off.
- When the battery power is low, please fly the drone back and charge the battery immediately.

# REMOTE

## 1. Function Overview of the Remote

Please take out the control stick parts from the bottom of the remote and install them on the remote first.

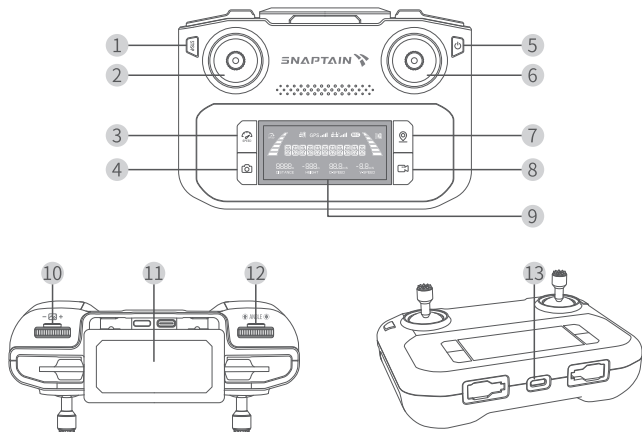

- |   |                       |
|---|-----------------------|
| ① Emergency Stop  | ⑥ Right Control Stick |
| ② Left Control Stick  | ⑦ Return-to-Home      |
| ③ Speed Switch(short press)/<br>ATTI Mode(long press)   | ⑧ Record Video        |
| ④ Take Photo  | ⑨ LED Display         |
| ⑤ Power Button(Press once to check<br>the battery power of the remote;<br>press once, then press and hold for<br>3s to power on/off the remote) | ⑩ Zoom in/Out         |
|   | ⑪ Phone Holder        |
|   | ⑫ Camera Up/Down      |
|   | ⑬ Charging Port       |

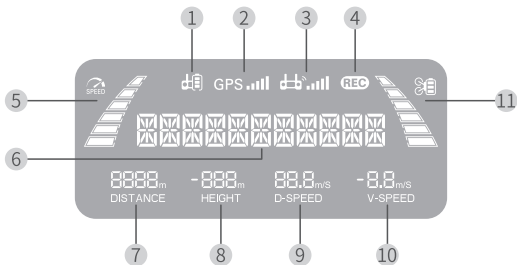

- |                               |                              |
|-------------------------------|------------------------------|
| ① Battery Power of the Remote | ⑦ Flight Distance            |
| ② GPS Signal Strength         | ⑧ Flight Height              |
| ③ Remote Signal Strength      | ⑨ Flight Speed               |
| ④ Photo/Video Status          | ⑩ Ascend/Descend Speed       |
| ⑤ Speed                       | ⑪ Battery Power of the Drone |
| ⑥ Status Display              |                              |

## 2. Operation of the Remote

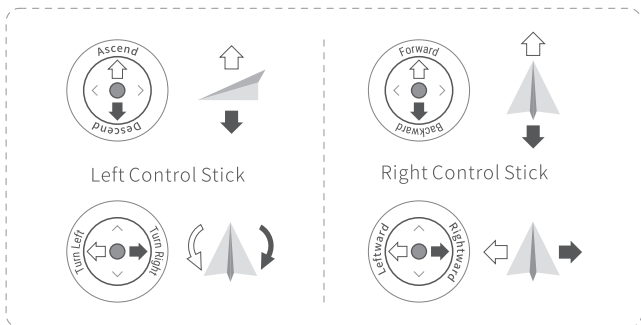

### 3. Right and Left Hand Modes Switching

Switching remote modes is only possible while the remote is off.

To switch to **Right Hand Mode**, long press the **Photo** button on the remote and do not release it. Next, press the **Power Button** once, then press and hold it for 3s until you hear three beeps. After that, the LED display will show "R HAND MODE".



#### Right Hand Mode



Left Control Stick



Right Control Stick



- To switch to the **Left Hand Mode**, just restart the remote.
- The drone is set to the **Left Hand Mode** by default.

# CHARGE

## 1. Charge the Battery for Drone

To charge the drone's battery, please connect one end of the USB charging cable to an adapter and the other end to the Type-C charging port of the battery. After a full charge, please install the battery into the drone.

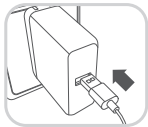

Adapter(Not Included):  
5V == 2A



Charging Time:  
About 180 Minutes

- The battery can be charged while in or out of the drone. It is recommended that you charge the drone's battery when it is off.
- Charging: Battery Power Indicators are flashing blue.  
Fully Charged: Four indicators become solid blue.
- It takes about 180 minutes to reach a full charge. The flight time of the drone is about 20 minutes.
- To remove the battery, please press the buckle on the battery and take it out from the drone.

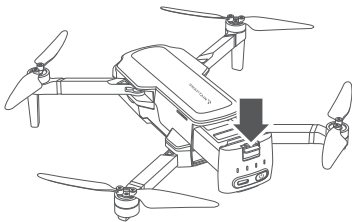

## 2. Charge the Remote

To charge the remote, please connect one end of the USB charging cable to an adapter and the other end to the Type-C charging port of the remote.

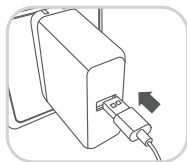

Adapter (Not Included):  
5V  $\equiv$  2A



Charging	Display CHARGING on the LED display
Fully Charged	Display FULL BAT on the LED display

The battery capacity of the remote is 3.7V/300mAh. It takes about 30 minutes to reach a full charge. The service life of a single charge can last about 90 minutes.

### Charging precautions:

- Avoid charging the battery or remote near high temperatures or heat, such as an open flame or an electric heater, as this could result in damage or explosion.
- Never hit or knock the battery against a rough surface.
- When charging the remote or battery, do not leave them unattended.
- Please do not immerse the battery in water. Store the battery in a dry place.
- Never disassemble the battery.

# FLIGHT OPERATION

In order to avoid unnecessary loss or damage, it is recommended that you fly the drone outdoors.

## Step 1: Power on the drone and place it on a level surface

- Press and hold the **On/Off button** on the battery for 3 seconds to power on the drone; the LED indicators of the drone will flash blue quickly.
- Place the drone on a level surface with its head forward and wait for the rear LED indicator to flash red slowly. The drone is ready for pairing with the remote.

## Step 2: Automatically pair the drone with the remote

- Press the power button on the remote once, then press and hold the same button for 3s to turn on the remote. The remote will be paired with the drone automatically.
- Upon a successful pairing, the LED display will show "GPS Mode", and the front LED indicator and the rear LED indicator will flash blue slowly.

## Step 3: Mobile Device Installation and App launching

- Pull out the phone holder at the top of the remote, then mount your mobile device into it. Make sure the mobile device fits the slots of the rubber pads on the remote.

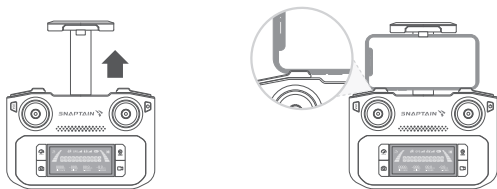

### Note

Remove PHONE CASE before mounting to prevent your phone from dropping off!



- Enable the WLAN of your mobile device, then connect your mobile device to the WiFi of SNAPTAIN-P30-\*\*\*\*\* and launch the Snaptain Fly App.

✓ SNAPTAIN-P30-\*\*\*\*\* 

Please refer to page 18 for instructions on how to download and install the App.

#### Step 4: Compass calibration

- Simultaneously push the left control stick to the upper right corner and the right control stick to the upper left corner to make the drone ready for compass calibration.

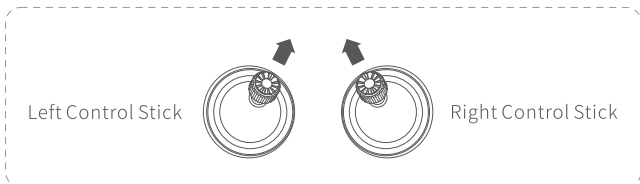

- The rear LED indicator: Flash blue and red quickly  
The front LED indicator: Flash blue quickly

#### \* Horizontal compass calibration

Hold the drone horizontally with its head facing forward, and turn it around your body (360°) until the rear LED indicator turns solid blue and red. You can also hear one beep from the remote. This indicates a successful horizontal calibration.

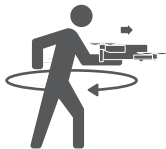

## \* Vertical compass calibration

Hold the drone vertically with its head facing down and turn it around your body(360°) until the LED indicators on the drone flash blue slowly. You can also hear one beep from the remote. This indicates a successful vertical calibration.



**Tip:**

The compass must be calibrated at the first-time use, and subsequent calibrations are not required unless the APP indicates too much interference.

### Step 5: GPS satellite search

Place the drone on a level surface after the compass calibration and wait for it to search for satellites. This process may take a few minutes.

When the LED indicators on the drone turn solid blue, the drone has found enough satellites.

### Step 6: Reset the drone/level calibration

- You must put the drone on a level surface when resetting; otherwise, the drone's attitude may be affected. Simultaneously push the left control stick to the lower left corner and the right control stick to the upper right corner to do the reset/level calibration.

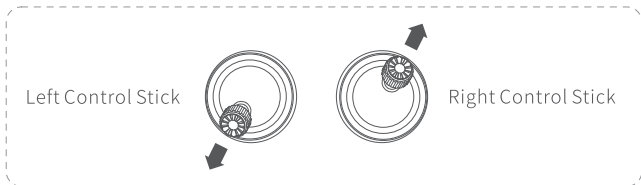

When the LED indicators on the drone flash blue quickly and then flash blue slowly, the reset or the level calibration is completed successfully.

### Tip:

During the first use, you must reset or make the level calibration, and you don't have to do it for future uses.

## Step 7: Unlock the motors

### Note

The drone can unlock its motors only after it searches enough GPS satellites.

- Simultaneously push the left control stick to the lower right corner and the right control stick to the lower left corner to unlock the motor. Propellers of the drone will begin to rotate.

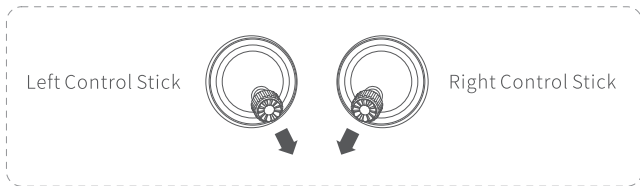

To stop rotating, do the same procedure again or just wait for 20 seconds.

## Step 8: Take off

- When all the LED indicators on the drone become solid blue, the drone is ready to take off.
- Push the Left Control Stick forward on the remote or tap  on the App to take off.

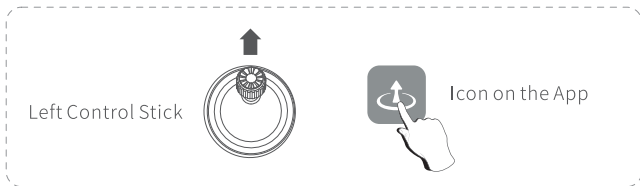

## Step 9: Land

- To land the drone, pull the Left Control Stick backward on the remote or tap  on the App to land.

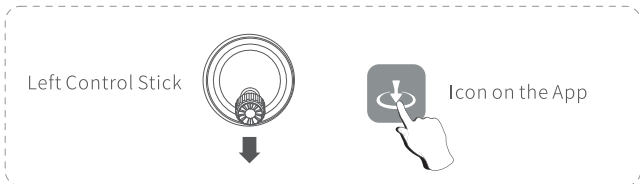

### \* ATTI Mode

For indoor flight or when the GPS signal is weak, please cancel the GPS mode and enter ATTI mode by pressing and holding the  button on the remote for 3 seconds before the drone takes off (this is not available during flight). All GPS-required functions will be disabled when ATTI mode is selected.

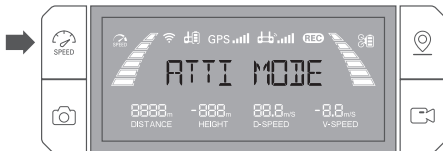

**Weak GPS Signal:** LED indicators on the drone keep flashing blue slowly.

**ATTI Mode:** The front LED indicator turns solid blue and the rear LED indicator flashes blue twice per second.

### \* Optical Flow Positioning

An optical sensor at the bottom of the drone allows it to hover stably at low altitudes without GPS signal or when GPS signal is weak.

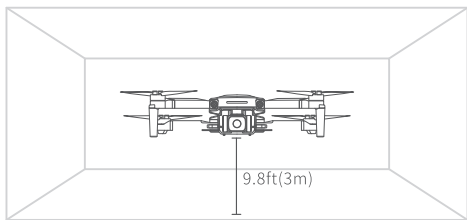

#### Notes

1. The optical flow sensor can assist a pilot in flight only when the surroundings are bright and textured, but it cannot completely replace the pilot's judgment. Don't rely too much on it; instead, pay more attention to the drone's situation and APP tips.
2. The performance of the optical flow positioning may be impaired in dark surroundings, areas with reflective surfaces(e.g. water), or at altitudes of more than 9.8ft(3m).
3. Ensure that the optical flow sensor is not blocked or interfered with.
4. The optical flow sensor only works in ATTI mode.

### \* Emergency Stop

Press the button  on the remote once and then hold it for 2 seconds to stop the drone in the air and make it drop. The function is only available when the height of the drone is lower than or equal to 16ft(5m).

### Notes

1. Stopping the motors mid-flight will cause the drone to crash. DO NOT stop the motors mid-flight unless you encounter an emergency situation.
2. This function should not be used during normal flight for landing; otherwise, your drone may be seriously damaged.

## SNAPTAIN FLY APP INTRODUCTION

---

### 1. Download and Install

Download and install **Snaptain Fly** on your mobile device from App Store™/Google Play™ or by scanning the QR code below.



For Android 8.0 and later



For iOS 10.0 and later

#### Step 1:

Go to the Wifi settings of your mobile device and connect to the drone's Wifi **SNAPTAIN-P30-\*\*\*\*\***. Make sure the drone is turned on.

#### Step 2:

Open **Snaptain Fly** and follow the in-app instructions to enter the main interface.

## 2. Smart Shooting Modes of the App

Short videos will be generated automatically according to the selected shooting mode.

### Far Fly

Step 1:

Manually point the camera at the subject. Make sure the drone is at least 6.6ft(2m) away from the subject.

Step 2:

Tap  >  on the App and slide to confirm.

The drone will fly backwards about 82ft(25m) while recording video with camera locked on the subject.

#### Notes

- \* After the task is completed, the drone will return to the take-off point.
- \* Push/pull the right control stick to exit this mode.
- \* Ensure there are no obstacles or crowds nearby to prevent injuries.

### Rocket Fly

Step 1: Manually point the camera at the subject. Make sure the drone is at least 6.6ft(2m) away from the subject.

Step 2: Tap  >  on the App and slide to confirm.

As the drone ascends about 49ft(15m), the camera locks onto the subject and the video is recorded simultaneously.

#### Notes

- \* After the task is completed, the drone will return to the take-off point.
- \* Push/pull the right control stick to exit this mode.
- \* Ensure there are no obstacles or crowds nearby to prevent injuries.

## Helix Fly

Step 1:

Manually point the camera at the subject. Make sure the drone is at least 6.6ft(2m) away from the subject.

Step 2:

Tap  >  on the App and slide to confirm.

With the camera locked on the subject, the drone spirals upward with a maximum radius of about 49ft(15m) and records a video at the same time.

### Notes

- \* After the task is completed, the drone will return to the take-off point.
- \* Push/pull the right control stick to exit this mode.
- \* Ensure there are no obstacles or crowds nearby to prevent injuries.

## Portrait/Landscape (VRT SC)

Tap  >  to shoot the video in portrait mode.

When this shooting mode is enabled, you can tap  again to change the image's aspect ratio. Aspect ratio options include 1:1, 3:4 and 9:16.

## Time-lapse Video

Step 1: Tap  and then  to shoot a time-lapse video.

Step 2: Slide to select a time-lapse magnification and tap **OK**.

Step 3: Tap  to start shooting and again to stop.



## Panoramic Shooting

Step 1: Tap  and then  to shoot a panoramic video.

Step 2: Tap  to begin shooting. The drone will rotate approximately 360° and take several pictures, generating a panoramic shoot. Once the shooting has been successfully completed, the App will prompt you.

## 3. Find My Drone via the App(Only Available in GPS Mode)

Step 1: Go to **Settings**  > **Track**, then tap **Find drone** to open a map.

Step 2: The location of the drone will be displayed on the map.

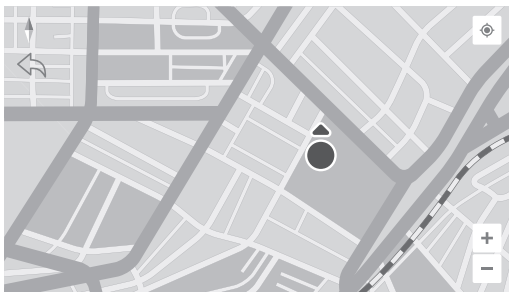

## 4. Share Videos/Photos on Social Media

Step 1: Launch the **Snaptain Fly App**, then tap  to access the media gallery.

Step 2: Select one or more photos you'd like to share, then tap to share it or them to a social media.

### Note

It is possible to share up to 9 pictures at once, but only one video at a time.

## 5. Download Videos/Photos into Your Mobile Device



Step 1: Connect your mobile device to the drone's WiFi, then launch the **Snaptain Fly App**.

Step 2: Tap  to access the media gallery.

Step 3: The photos and videos will be saved simultaneously to the App album and the memory card. The video resolutions on the memory card(4K) and App(720p) are different, so you can choose which one you want to download.

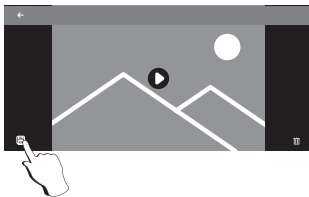
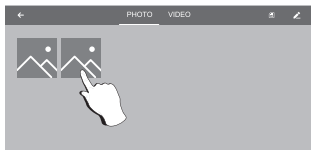
① Directly tap the photo or video you want to download, then tap  to download it from the App album.



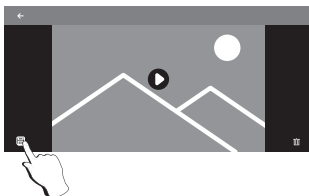
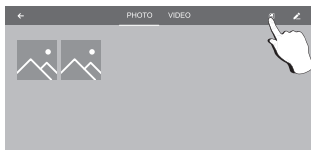

② Tap , then tap the photo or video you want to download, Next, tap  to download it from the memory card.





# SMART OPERATION FUNCTIONS OF THE APP

---

## 1. Waypoints (Route rules)

Step 1: Connect your mobile device to cellular data or the Internet, then go to the App and tap  >  to preload the real-time map.

Step 2: Connect your mobile device to the drone's WiFi, then go back to **Route rules**.

Step 3: Tap some desired waypoints (up to 16) in the red circle (limited flight range) on the map, then tap **GO** to upload them. If you want to reset the waypoints, you can tap  to delete one waypoint at a time or  to delete all waypoints.

Step 4: Slide on the pop-up window to begin the flight following the waypoint's route.

Step 5: Push or pull the right control stick to cancel this mode.

## 2. Point of Interest (Interest point)

Step 1: Hover the drone above the center you want it to circle around.

Step 2: Tap  >  , then set the POI radius.

Step 3: Slide on the pop-up window to start flying.

Step 4: Push the right control stick left or right to adjust the drone's circle direction (anticlockwise or clockwise), and push it forward or backward to adjust POI radius.

Step 5: Tap  again to cancel this mode.

### 3. GPS Follow Me (GPS follow)

The drone will follow the GPS on your mobile device when this mode is activated.

Step 1: Fly your drone at a distance of 33ft(10m) to 164ft(50m) away from you.

Make sure there are no obstacles between you and the drone.

Step 2: Tap  >  and wait for the App to display "Follow Me Ready".



Step 3: Slide on the pop-up window to start following. Afterwards, the drone will follow you(your mobile device).

Step 4: Tap  again to cancel this mode.

#### Notes

1. GPS Follow Me can be affected by tall buildings, trees, and areas with WiFi interference. It is recommended that you use this function in an open area and be aware of your surroundings. This drone is not capable of avoiding obstacles.
2. You can't use this function if your mobile device's GPS service is disabled or the GPS signal of the drone is weak.

### 4. Mark and Track (Image follow)

Step 1: Tap  >  , then follow the pop-up window to draw a precise box around the object which you'd like to track. The drone's camera lens will remain pointed at the object.

Step 2: Slide on the pop-up window to start tracking.



#### Tip:

Make sure you're flying the drone in a light-filled environment and that the box you draw precisely frames the object.

## 5. Return-to-Home(RTH)

The Return-to-Home(RTH) function brings the drone back to the last recorded Home Point where it took off last time. RTH works only when the GPS signal is strong enough and the compass is working properly. When the drone is in the ATTI mode, the RTH can't be performed.

### ① Smart RTH

In GPS mode, press the button  on the remote or tap  on the App to initiate Smart RTH. The remote will start beeping and the drone will return to the last recorded Home Point automatically.

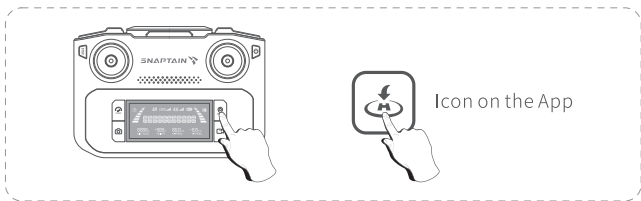

Press the button  or tap the icon  again to stop the RTH.

### ② Low Battery RTH

The Low Battery RTH will be triggered when the drone's battery power runs low. The drone will fly back to an altitude of 98ft(30m) above the last recorded Home Point and land.

The icon  will become red on the App.

### ③ Failsafe RTH







Failsafe RTH will be activated automatically when the remote disconnects from the drone. The drone will return to the last recorded Home Point.

If the signal is restored during the RTH, you can press and hold the button  for 2 seconds to cancel RTH.





#### Notes

1. During RTH, the drone is not capable of avoiding obstacles.
2. Never power off the remote when RTH is enabled; otherwise, the failsafe RTH will be activated.



## 6. Gestures for Photo/Video (Ges photo/Ges record)

- Tap  > , then slide to start taking photos. Within 9.8ft(3m) in light-filled conditions, the drone will take a photo while the camera points at the person who is making a "  " gesture with the right hand. photo by making a  gesture with your right hand .
- Tap  > , then slide to start recording a video. Within 9.8ft(3m) in light-filled conditions, the drone will start/stop recording a video while the camera points at the person who is making a "  " gesture with the right hand.

## PHOTO AND VIDEO

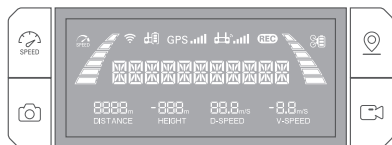
- ① Press the button  on the remote or tap  on the App to take a photo. When taking a picture, the LED display will show "Take Photo".
- ② Press the button  on the remote or tap  on the App to start recording a video. The LED display will show "VIDEO START". Press the same button or tap the same icon again to stop the recording, then save the video to your mobile device and the memory card simultaneously.



-  Take Photo
-  Record Video

ICON ON APP

### \* Check videos and photos

Option 1: You can check the photos and videos in the App's media gallery.

Option 2: The original photos and videos are saved to your memory card. To check all the files on the memory card, you can take the card out of the drone and connect it to a computer via a card reader.

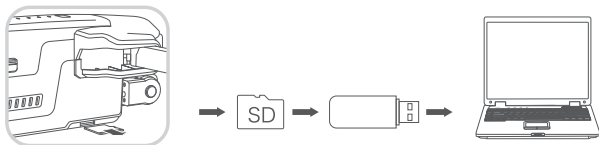

## LED INDICATORS DESCRIPTION

Drone Status	Front LED Indicator	Rear LED Indicator
Paired with Remote	Flash Blue Slowly	Flash Blue Slowly
Low Battery	Flash Quickly	Flash Red Quickly
Horizontal Compass Calibration	Flash Quickly	Flash Quickly to Solid on
Vertical Compass Calibration	Flash Quickly to Slowly	Solid on to Flash Slowly
Reset	Flash Quickly to Slowly	Flash Quickly to Slowly
Satellites Searched Successfully	Solid on	Solid Blue
Smart RTH	Solid on	Solid on
Failsafe RTH	Off	Flash Red Slowly
Low Battery RTH	Flash Slowly	Flash Red Quickly



## SPECIFICATIONS

Motor	Brushless
Control Range	1640ft(500m) (without interference)
FPV Range	1640ft(500m) (without interference)
Maximum Relative Flight Height	400ft(120m)
Flight Time	Up to 20 Minutes
Photo Resolution	4K: 3840*2160 Pixel
Video Resolution	1280*720 Pixel in Your Mobile Device 3840*2160 Pixel in the Memory Card
Photo Format	JPG
Video Format	MP4
Tilt Angle of the Front Camera	0°-90°
Storage	Save to APP's Gallery and Memory Card

## OTHER PARAMETERS

Drone		
Operating Temperature	32°F to 104°F(0°C to 40°C)	
Frequency Range	5150-5825 MHZ	
Transmit Power(EIRP)	<24 dBm	
Camera		
Controllable Range	Tilt: 0°-90°	
Remote		
Frequency Range	2408-2478MHz	
Transmit Power(EIRP)	<13 dBm	
USB Cable		
	For Drone Battery	For Remote
Input	5V $\equiv$ 2A	5V $\equiv$ 2A
Output	2 x 3.8V/1.2A	5V/1A
Rated Power	7.6W-10W	3.7W

## TROUBLESHOOTING

---

### 1. The drone can't be powered on or the LED indicators do not light up.

- \* Ensure that the battery is fully charged before inserting it into the drone.
- \* Ensure you have pressed and held the On/Off button on the battery for 3 seconds to power it on.

### 2. The drone can't take off under the control of the remote.

- \* Please ensure the remote has been successfully paired with the drone.
- \* When the drone is in GPS mode, please check if the drone has found enough satellites.
- \* When flying indoors, please activate the ATTI mode.
- \* Ensure that the remote has enough power.

### 3. When the App is launched, the live preview is not displayed.

- \* Make sure your mobile device is connected to the drone's WiFi.
- \* Be sure to turn off your mobile device's cellular data and Bluetooth.
- \* After you launch the App, if your mobile device pops up a window asking "The drone's WiFi can't access the Internet, are you sure to continue the connection?", please select "Yes". Selecting "No" will disconnect the drone's WiFi.
- \* When you launch the App for the first time, please grant all permissions required.

### 4. The images cannot be saved to the memory card or your mobile device.

- \* When you launch the App for the first time, please grant all permissions required.
- \* Ensure that the memory card or mobile device you are using has enough space.

#### 5. The image transmission is jammed or easily disconnected.

- \* Ensure that there are no obstructions between the drone and the remote (mobile device).
- \* Fly the drone in another place. Avoid flying near tall buildings or signal towers.
- \* Update the firmware of the drone via the app to the latest version.

#### 6. The drone doesn't hover stably.

- \* Fly the drone in another place. Avoid flying near tall buildings or signal towers.
- \* Recalibrate the drone and make a level calibration.
- \* Check whether the strong wind affects the flight. You should avoid flying your drone in adverse weather and strong winds if this is the case.
- \* Check if the propellers are deformed. If yes, please replace the propellers as instructed.

#### 7. The remote or the battery of drone can't be charged.

- \* Try to unplug the cable, then plug it again.
- \* Try another adapter or socket.

#### 8. The image is not clear enough.

- \* Make sure you have removed the protective film on the camera lens.
- \* A light-filled environment is most suitable for taking photos or recording videos.
- \* Go to **Settings > Image** to set a higher resolution.

## FCC Caution:

Any Changes or modifications not expressly approved by the party responsible for compliance could void the user's authority to operate the equipment.

This device complies with part 15 of the FCC Rules. Operation is subject to the following two conditions:

(1) This device may not cause harmful interference, and (2) this device must accept any interference received, including interference that may cause undesired operation.

Note: This equipment has been tested and found to comply with the limits for a Class B digital device, pursuant to part 15 of the FCC Rules. These limits are designed to provide reasonable protection against harmful interference in a residential installation. This equipment generates, uses and can radiate radio frequency energy and, if not installed and used in accordance with the instructions, may cause harmful interference to radio communications. However, there is no guarantee that interference will not occur in a particular installation. If this equipment does cause harmful interference to radio or television reception, which can be determined by turning the equipment off and on, the user is encouraged to try to correct the interference by one or more of the following measures:

- Reorient or relocate the receiving antenna.
- Increase the separation between the equipment and receiver.
- Connect the equipment into an outlet on a circuit different from that to which the receiver is connected.
- Consult the dealer or an experienced radio/TV technician for help.

For Remote:

This equipment complies with FCC radiation exposure limits set forth for an uncontrolled environment.

For R/C QUADCOPTER:

This equipment complies with FCC radiation exposure limits set forth for an uncontrolled environment .

This equipment should be installed and operated with minimum distance 20cm between the radiator& your body.

This transmitter must not be co-located or operating in conjunction with any other antenna or transmitter.

## ISED Warning:

This device complies with Industry Canada licence-exempt RSS standard(s). Operation is subject to the following two conditions:

- (1) this device may not cause interference, and
- (2) this device must accept any interference, including interference that may cause undesired operation of the device.

Le présent appareil est conforme aux CNR d'Industrie Canada applicables aux appareils radioexempts de licence. L'exploitation est autorisée aux deux conditions suivantes :

- (1) l'appareil ne doit pas produire de brouillage, et
- (2) l'utilisateur de l'appareil doit accepter tout brouillage radioélectrique subi, même si le brouillage est susceptible d'en compromettre le fonctionnement.

For R/C QUADCOPTER:

The device is compliance with RF exposure guidelines, users can obtain Canadian information on RF exposure and compliance. The minimum distance from body to use the device is 20cm.

Operation of this device in the band 5150-5250 MHz is restricted to indoor use only.

L'appareil est conforme aux directives d'exposition aux RF, les utilisateurs peuvent obtenir des informations canadiennes sur l'exposition aux RF et la conformité. La distance minimale du corps pour utiliser l'appareil est de 20 cm.

Le fonctionnement de cet appareil dans la bande 5150-5250 MHz est limité à une utilisation en intérieur uniquement.

For Remote:

The device is compliance with RF exposure guidelines, users can obtain Canadian information on RF exposure and compliance.

Le présent appareil est conforme Après examen de ce matériel aux conformité ou aux limites d'intensité de champ RF, les utilisateurs peuvent sur l'exposition aux radiofréquences et la conformité and compliance d'acquérir les informations correspondantes.

This transmitter must not be co-located or operating in conjunction with any other antenna or transmitter.

Cet émetteur ne doit pas être colocalisé ou fonctionner en conjonction avec une autre antenne ou un autre émetteur.