

Gardenigloo[®]

V2

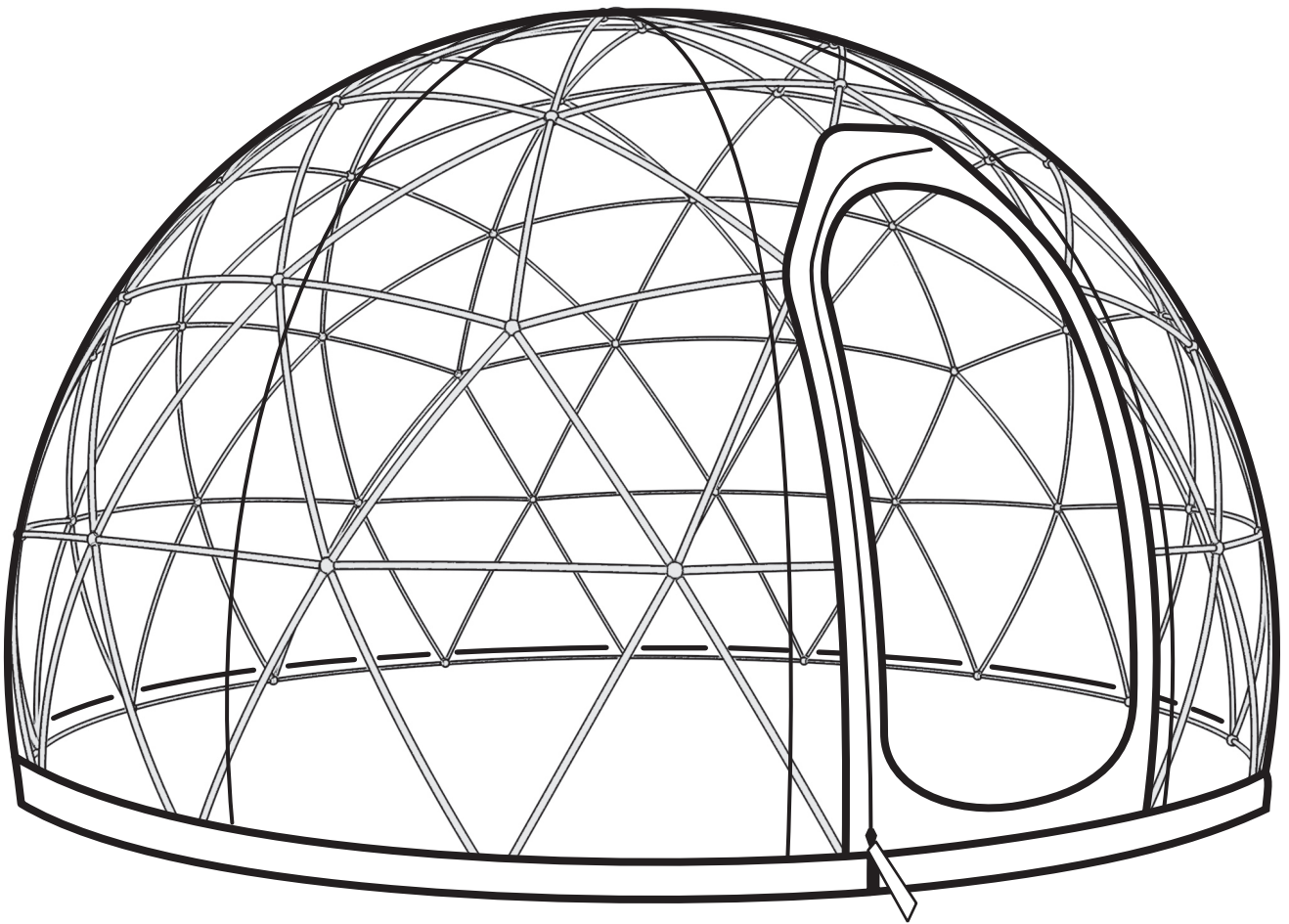

**OWNER'S COMMERCIAL UTILIZATION,
WARNINGS & MAINTENANCE MANUAL**

CONTACT US VIA E-MAIL AT:

contact@gardenigloousa.com

support@gardenigloousa.com

Other pages:

Installation/Instruction Manual: <https://gardenigloousa.com/pages/manuals>

Spec-Sheet: <https://gardenigloousa.com/pages/spec-sheet>

Spare Parts Form: <https://gardenigloousa.com/pages/spare-parts>

Return Policy: <https://gardenigloousa.com/pages/returns-policy>

Congratulations on acquiring your Gardenigloo!

We are confident that the Gardenigloo will prove to be beneficial to you throughout the seasons.

This manual contains:
instructions, warnings, case scenarios and procedures
regarding using the Gardenigloo in a Commercial setting.



REMINDER

As a business owner and/or manager, please be sure to read all warnings on PAGE 2 of the Gardenigloo Instruction Manual.

<https://gardenigloousa.com/pages/manuals>

CONTENTS

Chapter 1

INSTALLING and COMMERCIAL USE WARNINGS.....1

- 1.1 Awareness of Installing the Gardenigloo with Personnel, Employees or Handymen
- 1.2 Choosing a Surface to install the Gardenigloo on
- 1.3 Anchorage Kit and Installing the Gardenigloo onto a Surface
 - 1.3.1 *Weight Bags and Soft Surface Installation*
 - 1.3.2 *Metal Clamps and Hard Surface installation*

Chapter 2

COMMERCIAL USAGE and WARNINGS.....7

- 2.1 Permissions, State Officials, Flammability & Classification of the Gardenigloo (FOR COMMERCIAL USERS)
 - 2.1.1 *Possible Commercial usage Permissions and communication with State Officials*
 - 2.1.2 *Fire Departments and Gardenigloo Fire Retardancy*
 - 2.1.3 *Local Building Councils and possible regulations*
- 2.2 Weather Monitoring and Weather precautions regarding the Gardenigloo
- 2.3 Customer, Wildlife and Customer Behavior
- 2.4 Heating in Cold temperatures
- 2.5 Severe Rain and Air vents
- 2.6 Humidity, Condensation, Interior Heat and Air vents
- 2.7 Dealing with Hot days with direct sunlight
- 2.8 Storing your Gardenigloo
 - 2.8.1 *Removing the Gardenigloo cover*
 - 2.8.2 *Storing your joints and Struts separately*
- 2.9 Notes decorations and Ornamentation
 - 2.9.1 *In regard to lighting*
 - 2.9.2 *In regard to weighted attachments onto Gardenigloo structure*

Chapter 3

ROUTINE MAINTENANCE CHECK-UPS and WARNINGS.....16

- 3.1 Routine Joint-Strut connection Check-ups
- 3.2 Snowfall and Snow load
- 3.3 Cleaning methods
 - 3.3.1 *WARNING: Do not use the following materials!*
 - 3.3.2 *Surface Cleaning*
 - 3.3.3 *Disinfecting with Alcohol*
- 3.4 Counter-Wrinkling
- 3.5 Patching holes/tears
- 3.6 Routine Zipper Maintenance

Chapter 4

APPLYING FOR WARRANTY AND SERVICES.....20

- 4.1 Applying for warranty
 - 4.1.1 – *Warranty clarifications: On what is covered*
 - 4.1.2 – *How to make a warranty inquiry*
 - 4.1.3 – *What to include in visual information / photos*
 - 4.1.4 – *What to include in climate data (if needed)*
- 4.2 Applying for a Spare parts request

1. INSTALLING and COMMERCIAL USE WARNINGS

Note: for installation, see the Gardenigloo Owners Instruction Manual

The Gardenigloo is made of several “Struts” and “Joint” pieces, that form the Structure of the Gardenigloo. Via the provided Instruction manual and pieces, it would take approximately 2 hours with 2 people to form the Gardenigloo structure.



REMINDER

Please take your time in installing your Gardenigloo. Please view the supplementary installation videos to assist visualizing the installation process.

<https://gardenigloousa.com/pages/videos>

1.1 Awareness of Installing the Gardenigloo with Personnel, Employees or Handymen

If you or your team, handymen, or employees are tasked with installing the Gardenigloo, please first ensure that all who will work to install the Gardenigloo:

- Has properly read the entire Gardenigloo manual.
- Has properly watched the Gardenigloo installation videos.
- That all members are aware of the following warnings regarding installation of pieces, and storage and weather conditions.
- That all members are focused and are indeed aware of the process during installation.

The Gardenigloo takes approximately 2 hours (more or less) to fully install. If installing for the first time, do not rush the process. Rushing may lead to misplaced pieces, loss of pieces or breaking of pieces.



REMINDER

TO AVOID POTENTIAL RUSHING-INDUCED MISTAKES,
PLEASE ALLOCATE ENOUGH AMOUNT OF TIME TO YOUR EMPLOYEES TO
INSTALL THE GARDENIGLOO.

(With two people: Minimum 2 and a half hours per Gardenigloo)

STRUTS

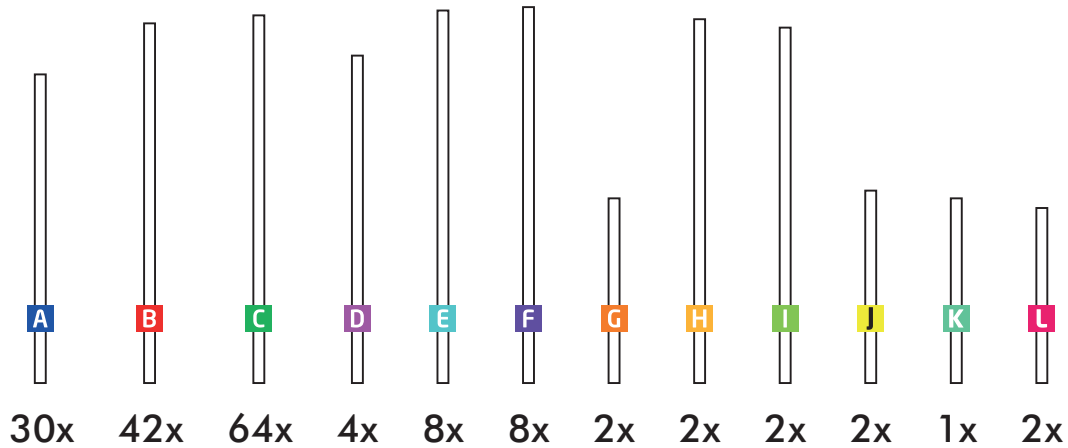

JOINTS

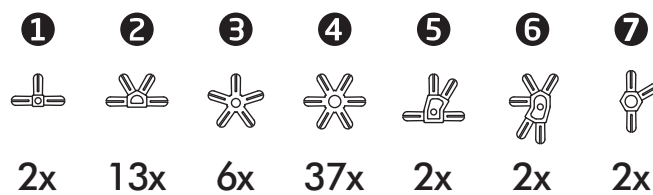

Each individual strut has a letter inscribed at its end. Such as A, B, C, and the like.

The pieces provided with the Gardenigloo has a factory quality control. No broken, missing, or incorrect pieces can be included within the Gardenigloo package. However, it is possible to acquire spare parts within a delivery time frame of 5-7 business days from date of confirmation. Please note that if the circumstances are outside warranty, parts are to be purchased.

See: <https://gardenigloousa.com/pages/spare-parts>

The packaging process of your Gardenigloo can also be re-assessed and monitored via the Serial number provided with each Gardenigloo set, for a manufactural review.

- The pieces provided with the Gardenigloo under no normal circumstances should ever arrive broken or easily break during installation. In most cases, improper installation or rushing or forceful insertion of pieces is the lead cause of installation complications.
- The struts and joints must fit into each other completely.
- **DO NOT PULL OUT ALL PIECES AT ONCE.** Pull only the required amount and type of pieces for the related installation step.



REMINDER

Double-check to ensure you have picked out the correct number and type of pieces. Once again, double-check to ensure you have picked the correct piece and placed it in the correct location.

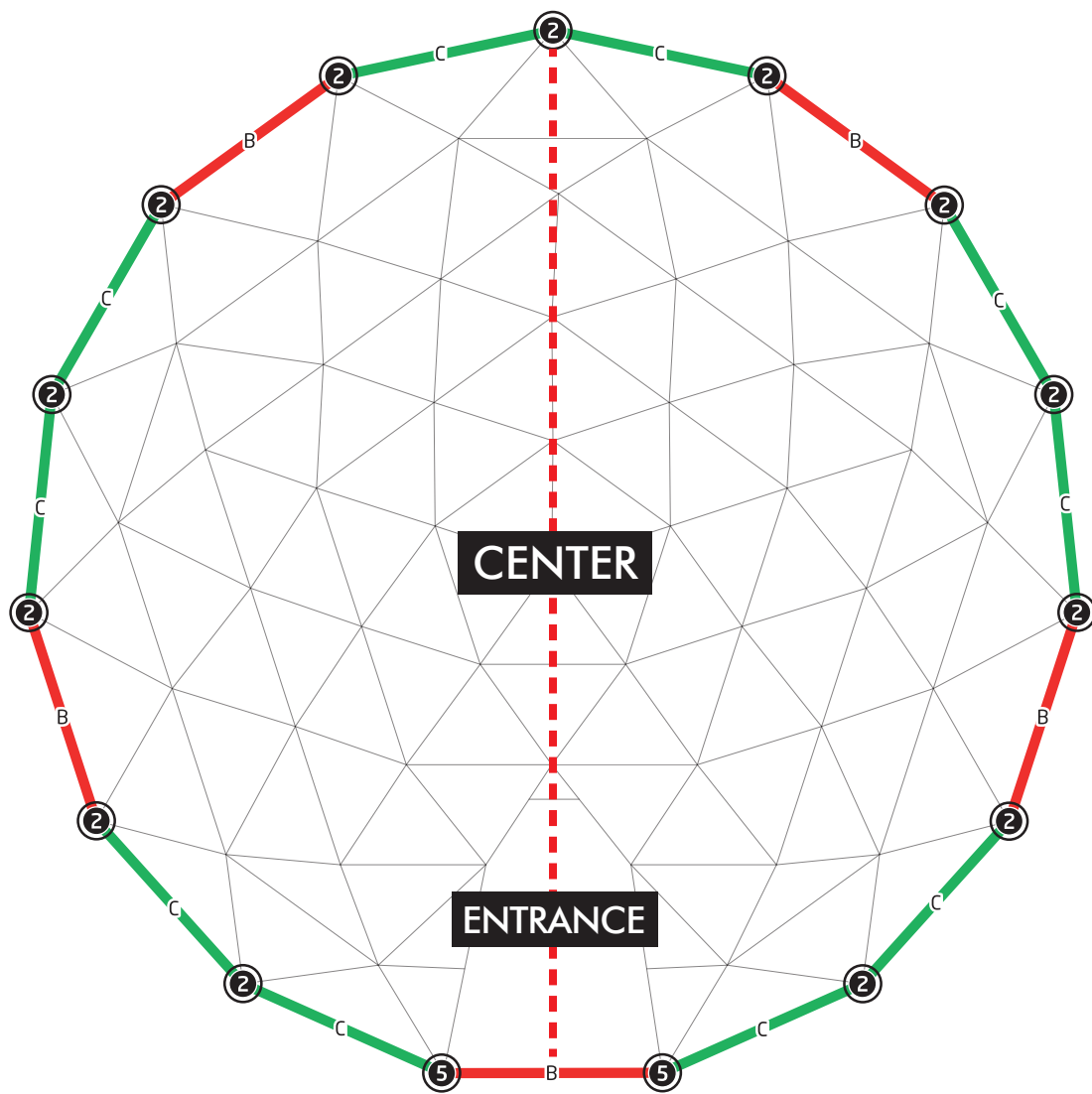

- Have a center guide and mark the location of the entrance to ease the installation process.
- Ensure that you are holding the correct piece and attaching it to the correct location.
- The Gardenigloo is a **symmetrical** structure, **one side should mirror the other**.
- During installation, if a wrong piece has been attached elsewhere, in future steps of installation **some parts may eventually come too short and/or build stress on the structure, at the risk of breaking or cracking**.
- When inserting a Strut piece into a joint connector, do not force or bend the joint into a perpendicular angle to the joint. This may risk breaking.
- Using WD-40 as lubricant may assist you to install your Gardenigloo in case you are having trouble getting the struts/joints to connect completely.

1.2 Choosing a Surface to install the Gardenigloo on

When installing the Gardenigloo, please consider natural elements such as water vapor, overnight condensation, rainfall, and flooding.

- Please be cautious and do not install the Gardenigloo on a surface susceptible to flooding.
- Please install the Gardenigloo on a flat, levelled, and stable surface.

In any case you may be installing directly onto soil or a deck/platform that is above soil:

- Please be aware that soil will naturally generate water vapor.
- This water vapor may leave the soil, enter and become trapped in the Gardenigloo causing condensation.

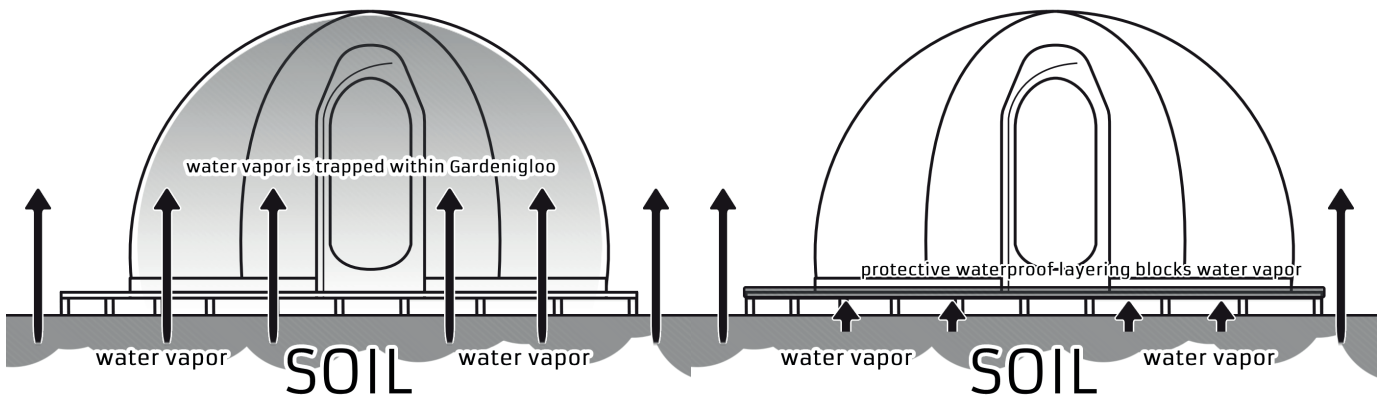

To avoid water from entering the Gardenigloo, place waterproof tarp beneath the platform or indoor/outdoor carpeting directly beneath the Gardenigloo.

Blocking the entry of water vapor from underneath the Gardenigloo will assist in avoiding condensation within the Gardenigloo.

1.3 Anchorage Kit and Installing the Gardenigloo onto a Surface

1.3.1 Weight Bags and Soft Surface Installation

To stabilize the Gardenigloo structure against wind forces, it is mandatory to install the provided anchorage kit. We provide 14 weight bags (to be filled with sand, 30 lbs each) 28 Velcro straps.

BASE WEIGHT BAGS

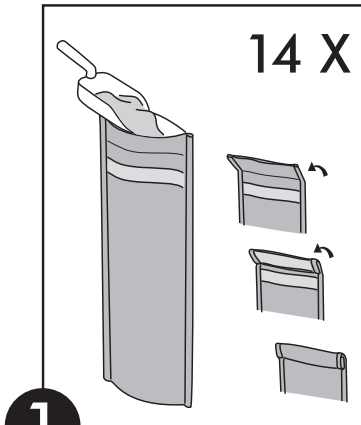

1

Always fill up your weight bags with dry, fine sand.

Weight (each):
approx. 30 lbs when filled

Weight (total kit):
approx. 420 lbs when filled

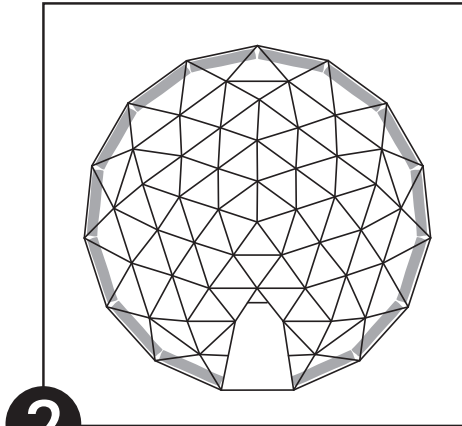

2

Position the weight bags as shown in the figure. Cover the base struts for even weight distribution.

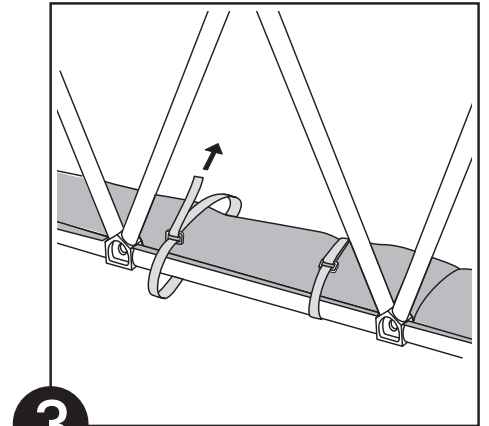

3

Tie each bag to the base struts at two points with velcro straps. Weight bags connect to the frame with velcros when in use to prevent movement/lifting.



REMINDER

It is mandatory to install ALL 14 weight bags. Skipping this step or implementing the weight bags poorly will jeopardize your Gardenigloo's wind resistance.

The Gardenigloo's wind resistance is limited at wind speed of 31 MPH. Please remove your cover in case you expect winds exceeding this limit.

1.3.2 Metal Clamps and Hard Surface installation

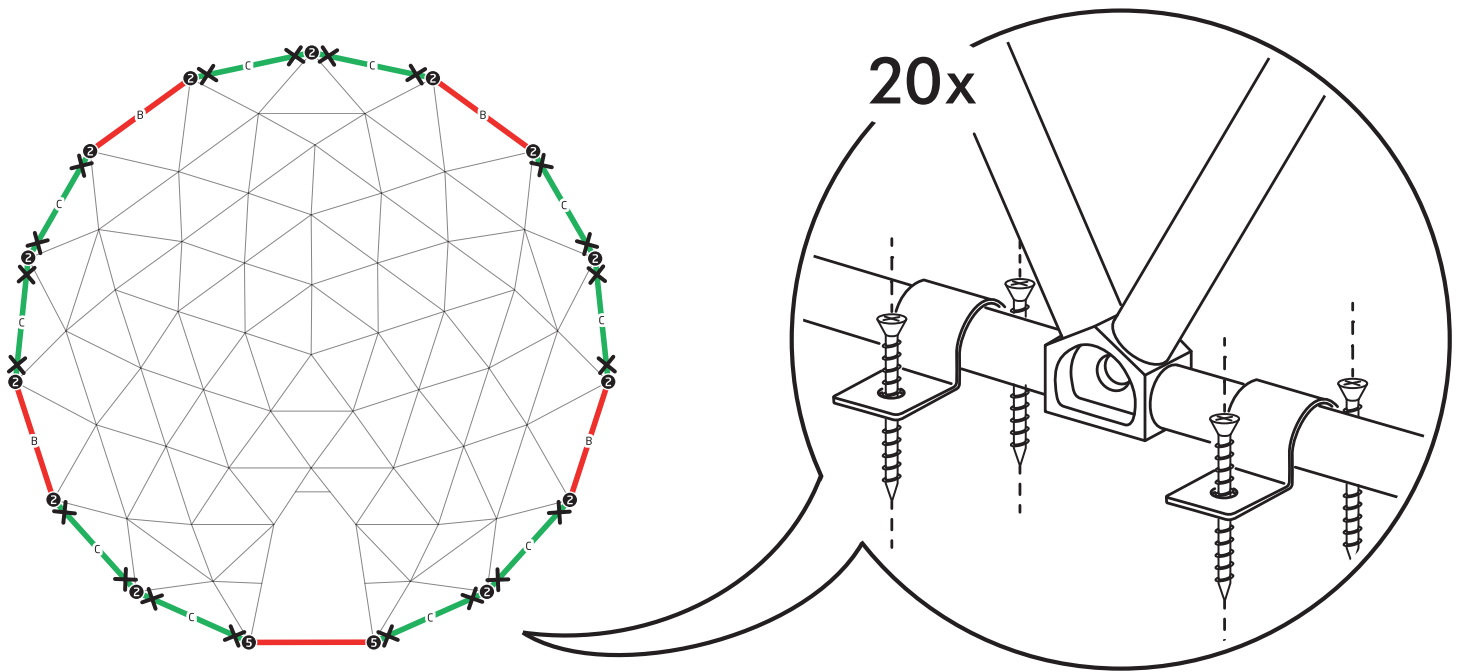

We also provide 20 metal clamps and 40 screws to be installed on surfaces where applicable. These clamps and the weight bags are used on the bottommost ring of the Gardenigloo Structure, alongside the weight bags.



REMINDER

Installing the anchorage kit in its entirety will assist in maximizing the potential wind resistance.

However, please be sure to always monitor the local weather conditions for wind speeds.

2. COMMERCIAL USAGE and WARNINGS

Note: for installation, see the Gardenigloo Owners Instruction Manual

2.1 Permissions, State Officials, Flammability & Classification of the Gardenigloo (FOR COMMERCIAL USERS)

2.1.1 Possible Commercial usage Permissions and communication with State Officials

Throughout the span of distributing the Gardenigloo to the USA and Canada from 2016 to 2020, we have rarely seen interference from outside parties. However, Local Fire Departments and Building Councils may take notice. Naturally, they may be concerned about the Gardenigloo.

Throughout our experiences with Owners of the Gardenigloo and local officials, we have encountered subjects such as:

1. Fire Retardancy, Flammability

(For more information, see: 2.1.2 - Fire Departments and Gardenigloo Fire Retardancy: NFPA 701 Regulated Fire testing)

2. Snow load

(For more information, see: 2.3.3 - Snowfall and Snow load: Technicalities regarding snow load calculation)

3. Material, dimensions, and object/ structure classification

(For more information, see: 2.1.3 - Local Building Councils and possible regulations: Material and Classification)

4. Wind resistance

(For more information, see: 2.2.2 - Wind Resistance: Utilize the Anchorage kit against the wind!)

What is important that the user acknowledges that they utilize the Gardenigloo in a commercial setting at their own risk: This being that the Gardenigloo can be placed in an environment where it could be subject to third-party damages. (I.E: The Gardenigloo Cover being stabbed by a child customers fork)

2.1.2 Fire Departments and Gardenigloo Fire Retardancy

For Fire Departments, NFPA Fire Regulations are crucial. Presenting Fire testing documentations is critical. Therefore, we shall share with Owners of the Gardenigloo previous testing of the Gardenigloo. (see attached documents)

We as Gardenigloo USA LLC are always willing to cooperate with any Fire Department/Local Council to ease concerns regarding the Gardenigloo and its Fire Retardancy to the best of our ability.

NFPA 701 Regulated Fire testing

The Fire Testing conducted at SGS NY Laboratories has concluded that the Gardenigloo's material has passed NFPA 701 Test Method 2 (related to flammability, result: non-flammable) and ASTM 84. (related to fire-spread, result: CLASS A or CLASS I rating.) **

*NOTE: **Related Fire testing documents available upon occasion and request. Contact us via E-mail.*

2.1.3 Local Building Councils and possible regulations

For Building Councils, each State has their own restrictions and classifications. Be wary of the classification of the Gardenigloo and compare it to the regulations in your local area. What is important to know is that Building Councils/Regulators will only approach you if they presume your utilization of the Gardenigloo is a threat to public safety.

Height, material, purpose, and fire-exit positioning are key points to be aware of-although very rarely problematic and enforced.

Material and Classification

The Material of the Gardenigloo is PVC and is classified as a "Tent". The PVC is used for the transparent cover of the PVC-plastic frames forming together to form a geodesic dome. The geodesic dome is used as a gazebo, conservatory, dining tent and greenhouse.

Related dimension/height/area information is included on the spec-sheet* of the Gardenigloo website, outside of detailed engineering/design information. **

*NOTE: *Link to spec-sheet: <https://gardenigloousa.com/pages/spec-sheet>*

***Gardenigloo USA LLC cannot provide the engineering spec and dimensions of the Gardenigloo. Such information is reserved by the Manufacturer.*

2.2 Weather Monitoring and Weather precautions regarding the Gardenigloo

As a Commercial user: Please be sure to constantly monitor the weather conditions in your area.

- Please ensure that all 14 weight bags (and if applicable metal clamps and screws) are completely installed onto the Gardenigloo as noted in the Instruction manual.
(No less than 14 weight bags)
- If local wind speeds exceed 31 MPH, please remove the cover. Otherwise, your Gardenigloo (Cover or Structure) may be subject to damage.
- If local weather shows intense hailstorms or tornados or risk of flying blunt objects, please remove your Gardenigloo. Objects may fly into the Gardenigloo and thus may be subject to damage.
- If the local temperature exceeds +50 degrees Fahrenheit, the interior of the Gardenigloo may spike up to 140 degrees Fahrenheit. Under direct sunlight, this heat may distort objects within the Gardenigloo and damage furniture. This may also harm plant life, animals, children, or yourself and your Gardenigloo.
- During snowfall, please be sure to regularly broom off excess snow from the top of the Gardenigloo. The Gardenigloo's snowload capacity is 90 lbs.



Weather or related environmental damages are not covered in the warranty.



2.3 Customer, Wildlife and Customer Behavior

As a Commercial user: Please be sure to monitor customer and customer behavior within the Gardenigloo. We advise to have cameras on site. Please be wary of customers/persons whom:

- If children attempt to use the Gardenigloo as a jungle gym and end up breaking furniture or pieces of the Gardenigloo.
- If children using (but not limited to) kitchen utensils attempt to stab at the Gardenigloo cover.
- If customers have difficulty with the Gardenigloo's zipper door. (see 3.5)
- If customers break the zipper door of the Gardenigloo and do not notify you of the problem.



REMINDER

In rapid temperature drops, water may enter the zipper teeth and freeze, causing jams.

In such circumstances, careless customers may force the zipper several times a day. This potentially risk of them eventually breaking or damaging the zipper. In cold temperatures please ensure to check for zipper jamming for each Gardenigloo and regularly use WD-40 to lubricate the zipper to avoid any freezing/jamming related zipper damages.

- If the customer attempts or directly/indirectly causes any damage to the Gardenigloo under the influence of alcohol.
- If the customer's pet or wildlife attempts or directly/indirectly causes any damage to the Gardenigloo.
- If the Gardenigloo is placed where automobile vehicular traffic is nearby.
- If the Gardenigloo may be susceptible to damage by acts of vandalism.



Customer or third-party related or wild-life damages are not covered in the warranty.



2.4 Heating in Cold temperatures

! Place portable (or cable) electric space heater facing towards the CENTER of the Gardenigloo.

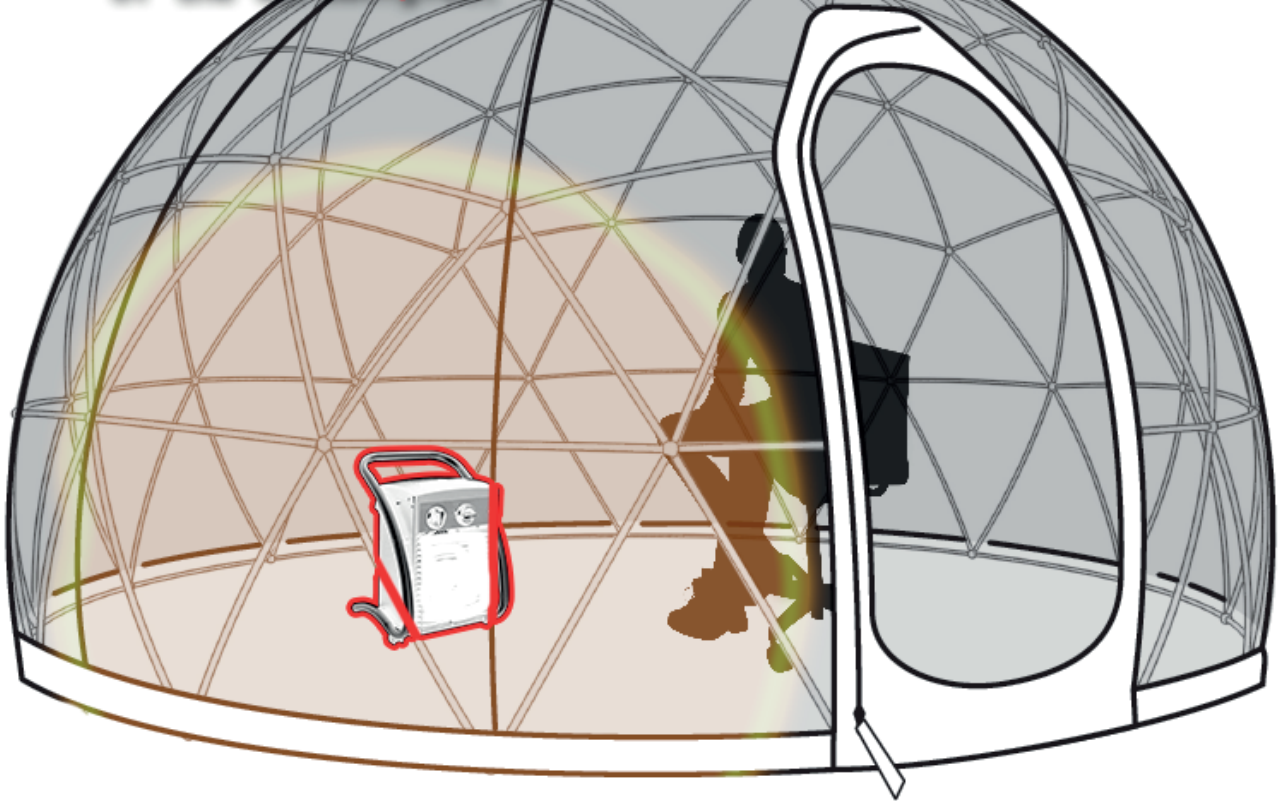

REMINDER

We as Gardenigloo USA LLC always urge Owners to use outdoor type, electrical space heaters.

Never use*:

- Propane or gas-based heaters
- Open fire heating sources
- Charcoal or coal-based heating

*NOTE: *We urge Owners of the Gardenigloo to not to use gas-based or fire-based heating sources due to the risk of Carbon monoxide poisoning and smoke-fume poisoning they may create in a closed environment. The Gardenigloo structure and cover is not flammable, however Carbon monoxide poisoning is a risk that we must mention. Please use your Gardenigloo responsibly.*

2.5 Severe Rain and Air vents

In the case scenario of rain, severe rainfall, it would be a wiser to pick a location not susceptible to potential flooding.



REMINDER

However, please be aware that the Gardenigloo is not designed to deal with flooding from underneath.

It would be advised to anticipate cases of water puddles building up, and to install the Gardenigloo to a relatively higher ground level.

2.6 Humidity, Condensation, Interior Heat and Air vents

Throughout usage in the winter, or with the rising temperatures in spring, humidity may become an issue. To deal with increasing humidity and/ or vapor condensation inside of the Gardenigloo: We urge you to open your Air vents momentarily.



REMINDER

Depending on how and where the Gardenigloo is installed, elements such as grass, plants, human breath, water droplets from clothes and the soles of boots, puddles/mud seeping underneath into the Gardenigloo -- shall cause condensation in the Gardenigloo.

In short, any introduction of water or water vapor inside the Gardenigloo may naturally cause condensation.

Furthermore, cold air in the Gardenigloo (at night) may turn condensate into water in the morning depending on the climate & humidity of your area. We urge you to open an air vent very slightly if this happens consistently. Please watch for wild animals, or curious individuals who would attempt to always force entry from the air vents.

In any instance of condensation, we urge you to use a Microfiber towelette to wipe off any accumulated water droplets on the Gardenigloo cover. Please be sure to mop the surface where the Gardenigloo is installed or dry it to get rid of any water.

If constant condensation is an issue, worst case scenario, we would recommend a dehumidifier.

2.7 Dealing with Hot days with direct sunlight

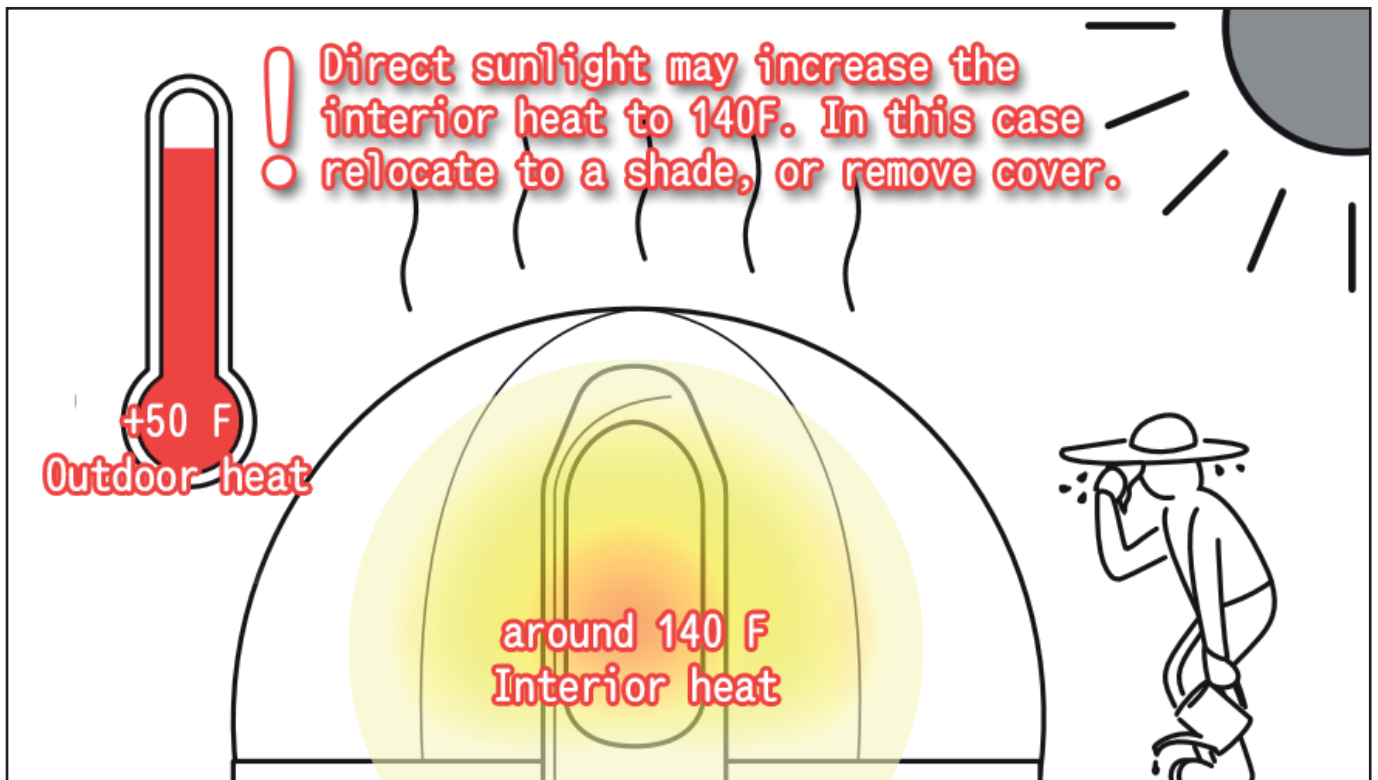

The transparent cover is not designed for outdoor use throughout the year. It can withstand temperatures between -4°F (outer temperature.) and $+140^{\circ}\text{F}$ (inner temperature.) and sunlight up to level 5 in the UV index.

On sunny spring/summer days with an outdoor temperature of over $+50^{\circ}\text{F}$: The temperature inside the Gardenigloo can quickly rise up to $+140^{\circ}\text{F}$ and above. **This can damage you, other users, your animals, the various furniture, and plants, as well as your Gardenigloo.**

FURTHER INSTRUCTIONS:

- Monitor the outdoor temperature if it is above $+50^{\circ}\text{F}$.
- Open the vents for the air to circulate and exit. At indoor temperatures of $+140^{\circ}\text{F}$ and over, you should remove the transparent cover.
- As an alternative: Relocating your Gardenigloo to a more shaded area or blocking direct sunlight to the Gardenigloo is also helpful. However, please be sure to monitor the outdoor heat. This alternative is not a definite solution.

By protecting the cover from strong UV rays in this way, the service life-of-expectancy of the cover will also be prolonged.

2.8 Storing your Gardenigloo

2.8.1 Removing the Gardenigloo cover

To remove your Gardenigloo cover, follow the installation steps on page 23-24 of the "Gardenigloo's Owners Instruction Manual" **in reverse**. Once completed and folded accordingly, keep your cover in a safe waterproof room with **consistent room temperature**.

Please avoid storage of the PVC cover in direct sunlight, high temperatures and/ or high humidity. Our recommendation for storage conditions is between 10-30 degrees Celsius (50-86 degrees Fahrenheit) and less than 50% humidity.

2.8.2 Storing your joints and Struts separately

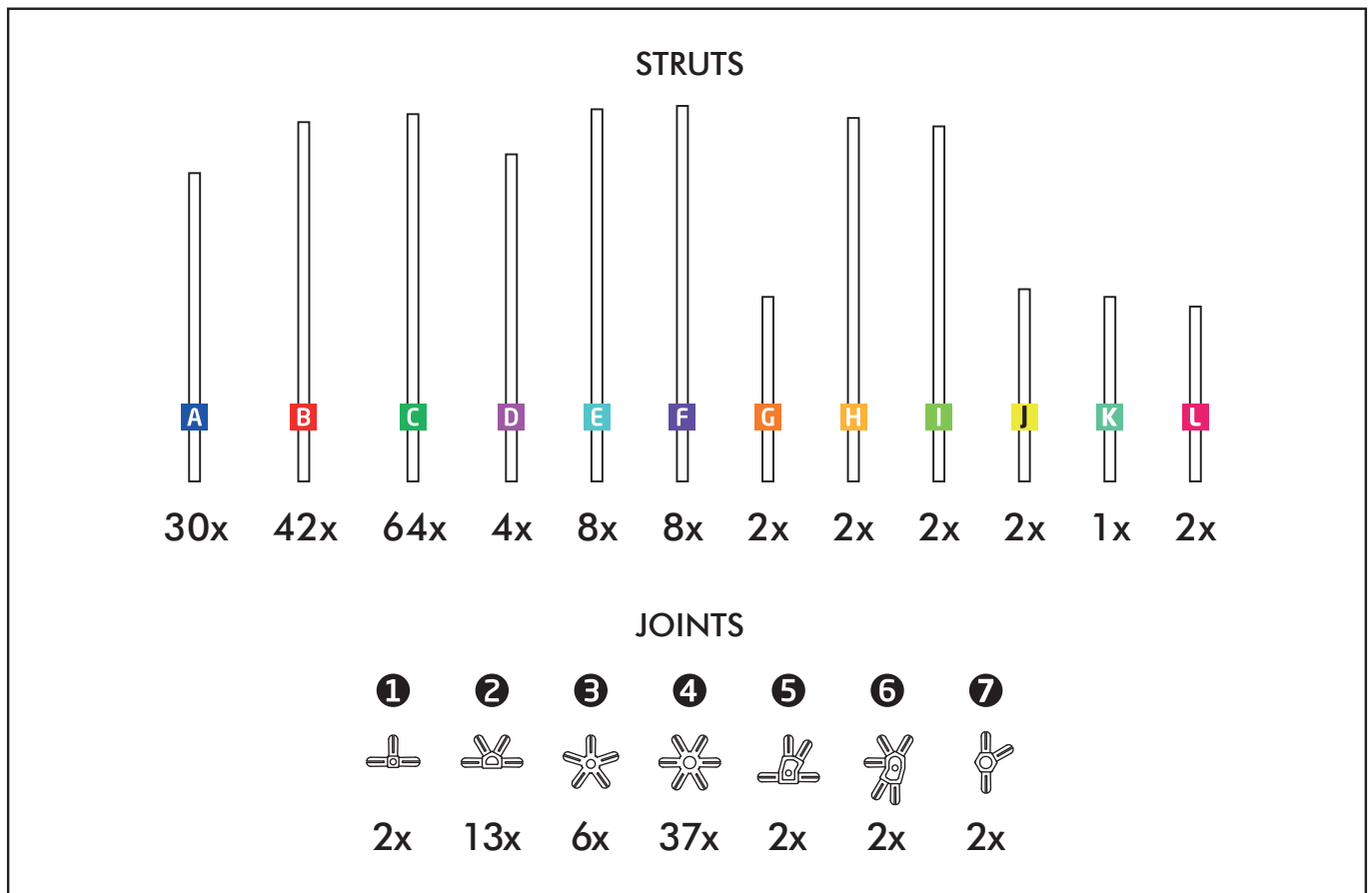

The Gardenigloo comes with several struts and joint pieces. All struts have a letter inscribed to their ends, such as A, B, C, and the like.

To make things easier for future installation, we urge you to group these pieces separately. Such as grouping all "A Struts" with a rubber band, and placing all "Joint #4" s in a separate bag.

2.9 Notes decorations and Ornamentation

2.9.1 In regard to lighting



LED Strip lights are a more common, safer, and relatively cheaper alternative to lighting.

Owners of the Gardenigloo may choose to decorate their Gardenigloo(s) with lighting attachments. (Gardenigloo does not sell or distribute any lighting elements.)

We urge all owners to use LED-type strip lighting systems.

Lighting systems that generate heat, and that are directly in contact with the Gardenigloo cover may leave unprecedented marks onto the cover. **MUST NOT TOUCH. MUST NOTE USE.**

2.9.2 In regard to weighted attachments onto Gardenigloo structure

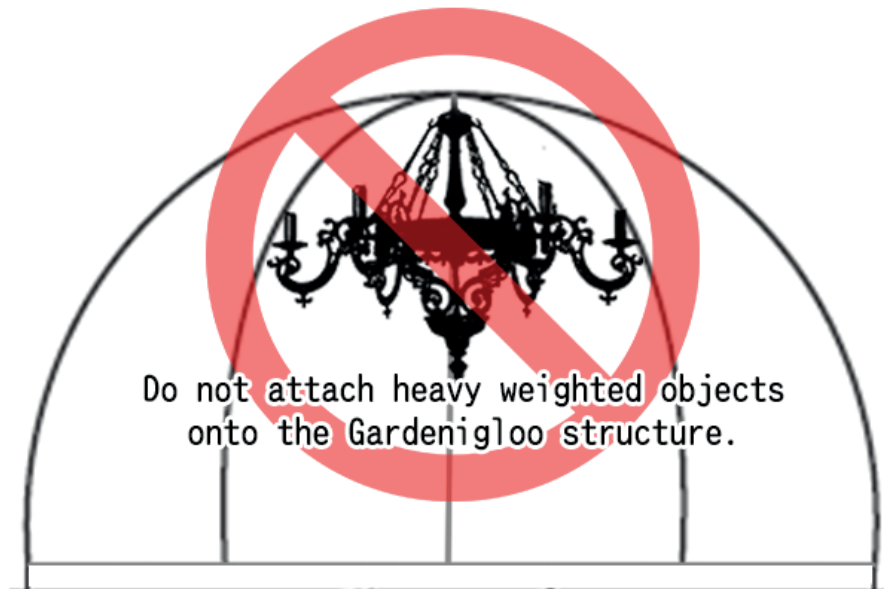

Owners of the Gardenigloo may choose to decorate their Gardenigloo(s) with various ornaments. (I.E: Bells, Christmas Accessories, vegetation, etc.)

However, attaching heavy objects directly to the structure of the Gardenigloo (the struts and rods) may lead to an increased load on the structure.

(I.E: Attaching a chandelier to the top of the Gardenigloo.)

This may lead to some parts of the structure breaking, bending in a way it was not designed for. Which may also lead to unanticipated risks regarding the user's safety.

3. ROUTINE MAINTENANCE CHECK-UPS and WARNINGS

Please be sure that all personnel tasked with monitoring the Gardenigloo are aware of routine check-ups and regular inspect the Gardenigloo in a responsible manner.

3.1 Routine Joint-Strut connection Check-ups

Secure all struts into their respective joints.

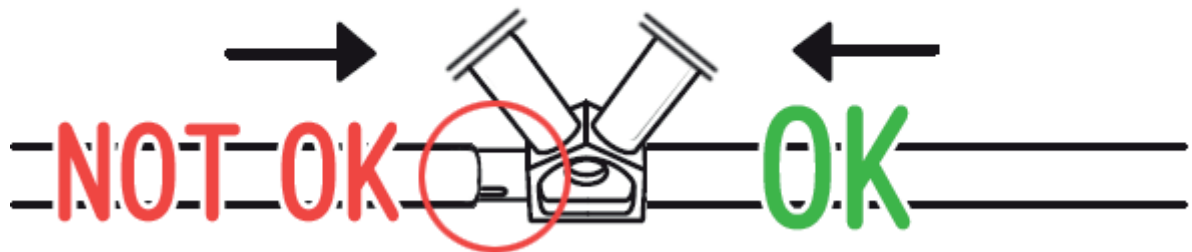

Otherwise, cracks may occur in time when left unattended.

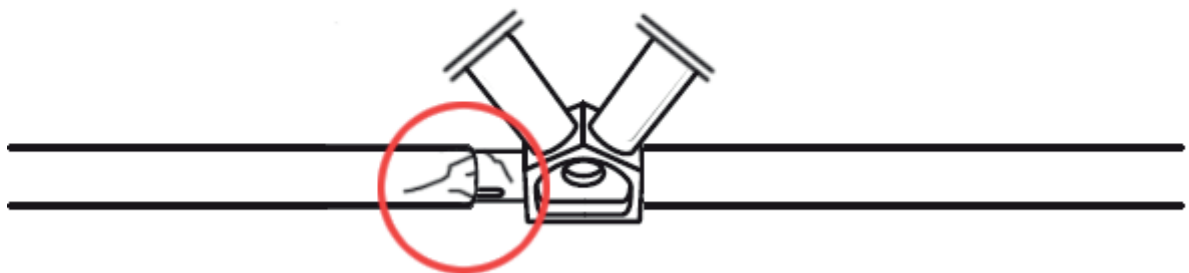

When observing your Gardenigloo, be sure to check every ring from bottom-to-top to see if any struts have become loose or detached from their respective joints.

Ignoring or not securing struts may possibly lead to cracks due to pressure and constant change of outdoor heat. Although not an immediate danger for the entire structure, it would be wiser to not leave it ignored. We urge Gardenigloo Owners to monitor the connections between struts and joints day by day.

3.2 Snowfall and Snow load

We urge all users of the Gardenigloo product to broom off the accumulation of any snow in regularly fashion.

Per the spec-sheet we have provided on our website, gardenigloousa.com , we have made the following statement: "Snow resistance: Maximum snow load capacity: 90 lbs "



Image: A Gardenigloo that has been left unattended for days, observe accumulation of snowfall.

Technicalities regarding snow load calculation:

To elaborate: The material of the Gardenigloo is PVC, resulting in a smooth and slippery surface.

- Due to the general shape of the Gardenigloo, the slope enables most of the accumulating snowfall to slide off the surface and fall to the ground.
- The only possible surface area that would allow accumulation of snowfall would be 3 m². (From the center-point at the top of the half-sphere, to a radius of approximately 2 meters.)
- We must also mention that we do not calculate using compacted snow.
- Newly fallen snow more typically weighs in at 70 to 150 kg per cubic meter (or 4.4 to 9.4 lb/cubic foot). Typically, winter snowpacks have a density of 200-300 kg per cubic meter. (or 12.5-18.7 lb per cubic foot)
 - Which results in a total of a maximum 10 centimeters thickness of accumulated snowfall on the available surface area.

3.3 Cleaning methods

3.3.1 WARNING: Do not use the following materials!

When cleaning/disinfect and wiping your Gardenigloo, do **NOT USE** the following materials:

- Do NOT use Bleach and/or Bleach mixtures,
- Do NOT use Mr. Clean, Mr. Muscle or similar brand heavy detergents and cleaning products,
- Do NOT use acidic or high-grade acidic chemicals,

3.3.2 Surface Cleaning

MILD SOAP + WARM WATER + MICROFIBER TOWELETTE

Wipe off the accumulated dirt with water and a microfiber towelette. You may also use a common garden hose for watering, however, do not use hoses with high water pressure.

Wipe off the water from the Gardenigloo surface to avoid any accumulation of humidity in the interior of the Gardenigloo. Open the vents and allow the air to circulate to speed up the drying progress.

The PVC film should only be cleaned with a diluted solution of mild soap and warm water. Rinse with clean water and dry with a soft cloth or a sponge, make sure the film dries thoroughly before folding. Do not use solvents or chemical cleaners. Do not expose sheets to abrasion. The surface can be scratched by rubbing with a coarse cloth.

3.3.3 Disinfecting with Alcohol

For disinfecting, we urge you to use a %80 Ethyl Alcohol %20 Water mixture. Placing this mixture into a spray would be for the best of convenience for the user. Spray into the air while having the air vents open to regulate humidity. **Most viruses thrive in high-humidity environments.**

3.4 Counter-Wrinkling

Upon installing your Gardenigloo (newly, or after packing it up), you may notice that there may be wrinkles on the cover. This is due to the cove being folded for a prolonged amount of time. For it to revert into its original appearance, simply expose it to outdoor elements for 4-to-6 days. **

***Installing your Gardenigloo before any important event would be advised, in any case the wrinkles appear unaesthetic to some users.*

3.5 Patching holes/tears

In cases where your Gardenigloo cover is indented, ripped, or torn slightly from a various point, a user may choose** to cover that hole/tear with simply Gorilla Tape, or Strong Clear Tape.

*NOTE: **In case the user seeks for a replacement;
see more information in CHAPTER 4 – WARRANTY AND SERVICES*

Furthermore, before patching: Always make sure to take a picture of the tear. If it happens again, you will be able to compare the similarities of the tears to see what the issue at hand may be.

3.6 Routine Zipper Maintenance



REMINDER

In rapid temperature drops, water may enter the zipper teeth and freeze, causing jams.

In such circumstances, careless customers may force the zipper several times a day. This potentially risk of them eventually breaking or damaging the zipper. In cold temperatures please ensure to check for zipper jamming for each Gardenigloo and regularly use WD-40 to lubricate the zipper to avoid any freezing/jamming related zipper damages.

We must mention that zipper related damages are not covered in the warranty. Depending on the occasion, Zipper replacements may be applicable solution. However, you may also contact your local Tailor to see if they may provide an on-site remedy.

As a precaution regarding the zipper, we urge you to use WD-40 to avoid liquids freezing the zipper.

STEP 1:

Defrost the zipper line using warm water on the zipper teeth. Quickly dry the zipper using microfiber towelettes until completely dry.

STEP 2:

Apply the lubricant onto the zipper and zipper teeth.

STEP 3:

Apply the lubricant every couple of days, especially in very cold temperatures.

WARNING:

Failure to use the lubricant may cause freezing, which may have the user force the zipper leading it to break off to get out.

4. APPLYING FOR WARRANTY AND SERVICES

4.1 Applying for warranty

4.1.1 Warranty clarifications: On what is covered

As Gardenigloo USA LLC, and as the sole distributors of the Gardenigloo brand to the USA and Canada we offer a Warranty service to all Gardenigloo owners. In such cases of approved warranties, we will provide replacement covers and/or spare parts free-of-charge.

We offer a LIMITED ONE YEAR WARRANTY. It is important to know that we as Gardenigloo USA LLC will only accept manufactural faults to be covered by warranty. Neglect and/or personal mistakes of any kind will not be approved by our manufacturer. Our manufacturer's observation is key to apply warranty.

The following instances **are covered**:

- The Gardenigloo does not perform at the expected standard. Forming of awkward and geometric cracks, and overall poor performance of the included cover.
- Pieces that were not provided in the Gardenigloo box shall be provided.
- Struts and joints that became brittle shall be replaced if user account is approved. If not, spare parts are to be purchased.

The following instances **are NOT covered**:



- An acquaintance, customer or wild animal tearing/cutting through the cover with a utensil, tool, or the like. This is classified as damages inflicted by a third-party. This will nullify your Warranty. A replacement cover will **not** be issued. **WE STRONGLY ADVISE USING CAMERAS TO MONITOR YOUR VICINITY AND GARDENIGLOO IN CASE OF AN ACT OF VANDALISM.**
- Using bleach, chemicals, or mixtures outside the advised cleaning materials leaving a mark on the Gardenigloo will nullify your Warranty. A replacement cover will **not** be issued.
- The Gardenigloo hovering/flying away and breaking due to rapid winds outside the warned wind speeds and poor utilization of the Anchorage kit. Such accounts are not covered per warranty, and a replacement cover or parts will **not** be issued.
- The Gardenigloo structure being snapped into pieces due to sudden wind and poor utilization of Anchorage kit. Such accounts are not covered per warranty, and a replacement cover or parts will **not** be issued.

4.1.2 How to make a warranty inquiry

In any case of your Gardenigloo not performing to the expectations presented, the best way to inquire for a Warranty is assuming direct contact with us.

Simply contact via e-mail:

support@gardenigloousa.com

or

contact@gardenigloousa.com

In your inquiry, we require the following information:

- Your account/experience with the Gardenigloo and what issue you would like to be resolved
- Your Order number / Purchaser name and Shipping Address
- Your Gardenigloo's Serial Number (Located at the bottom of the entrance)
- Visual information / photos of the issue at hand (As clear as possible, from different angles, inside-outside)
- Climate / weather forecast data (Only if relevant)

Upon receiving this information, the data will be sent and discussed with our Manufacturer. Providing us this data will assist us in providing our manufacturer your user experience.

4.2 Applying for a Spare parts request

In any case of broken, missing, split, lost or unusable struts or joints, you may always make a spare parts request via e-mail. Simply fill in (by hand or by computer) the "Spare Parts Form"* and sent it to either **support@gardenigloousa.com** or **contact@gardenigloousa.com**.

Photos, screenshots or scans of any kind are accepted.



REMINDER

Please keep in mind that Spare Parts take time to be gathered and normally have a cost, in cases outside of warranty.

All Spare Parts orders are subject to a 3-5 business day delivery wait time.

Each individual strut has a letter inscribed at its end. Such as A, B, C, and the like.

The list of all parts needed to fully assemble a Gardenigloo is noted on the first page of the Owners Instruction Manual**.

NOTE: *Direct link to the Spare Parts Form: <https://gardenigloousa.com/pages/spare-parts>

**Direct link to Instruction Manual: <https://gardenigloousa.com/pages/manuals>

CONTACT US VIA E-MAIL AT:

contact@gardenigloousa.com

support@gardenigloousa.com

Other pages:

Installation/Instruction Manual: <https://gardenigloousa.com/pages/manuals>

Spec-Sheet: <https://gardenigloousa.com/pages/spec-sheet>

Spare Parts Form: <https://gardenigloousa.com/pages/spare-parts>

Return Policy: <https://gardenigloousa.com/pages/returns-policy>