

Notes:

- Maximum Electric Current:

AWG	16	14	
AMP	18	30	
- Maximum Electric Rating: 105°C 600 Volts Max
- Insulation Material: Vinyl
- Insulation Color: Blue
- Terminal Material: Copper
- Wire Range: 16-14 AWG (1.5-2.5mm²)
- Terminal Surface Treatment: Tin Plated
- Terminal Thickness: 0.80mm

Standard (Metric)

- 0.89" (22.5mm)
- 0.26" (6.5mm)
- 0.45" (11.5mm)
- 0.25" (6.4mm)
- 0.17" (4.3mm)
- 0.09" (2.3mm)
- 0.18" (4.5mm)

Tolerances

(Unless Otherwise Specified)

CATEGORY	Vinyl Insulated Fork Terminals	SCALE	4/1
PART #	SVES2-4	SHEET	1-3
MATERIAL	Tin-Plated Copper	PAGE	10F2

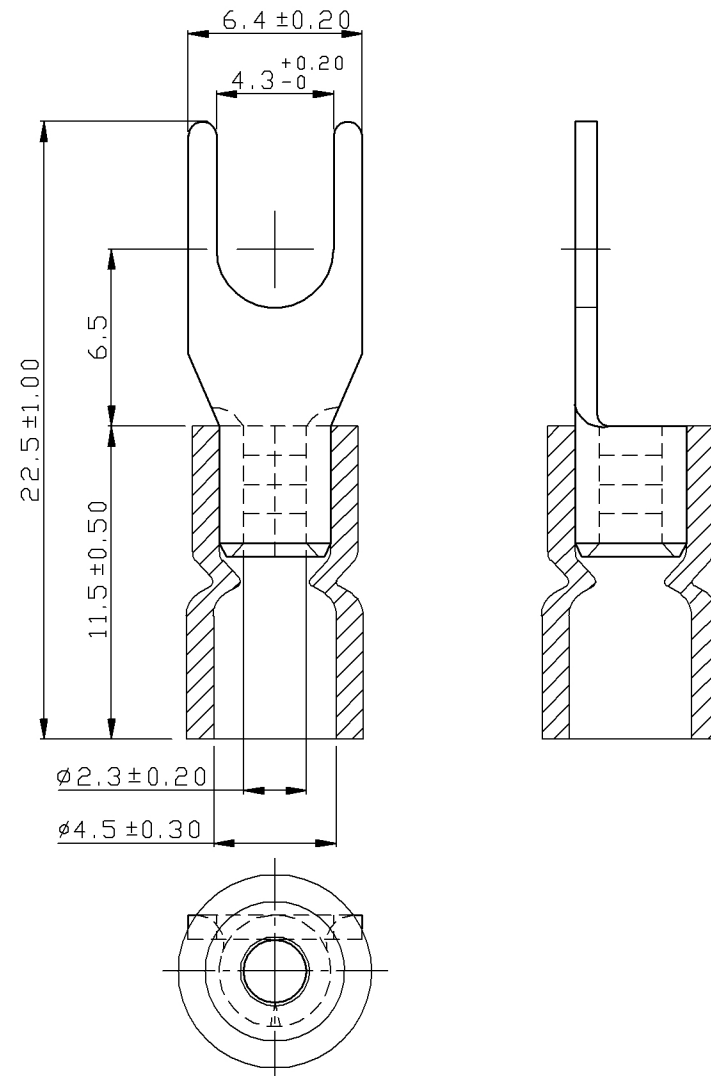

FerrulesDirect