

## Notes:

1. Maximum Electric Current: 7A
2. Maximum Electric Rating: Up to 2000V
3. Terminal Material: Copper
4. Wire Range: 24 AWG (0.25mm<sup>2</sup>)

### Standard (Metric)

L1: 0.20 (5.0mm)  
D: 0.04 (1.1mm)  
D1: 0.03 (0.8mm)  
D2: 0.59 (1.5mm)

### Tolerances

(Unless Otherwise Specified)

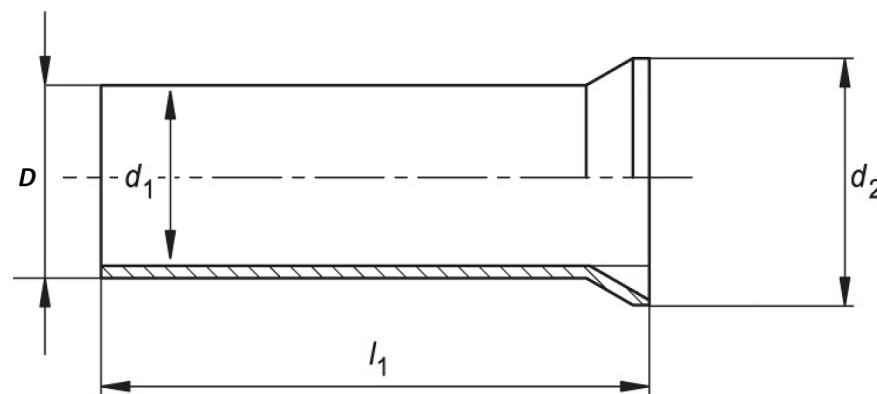

CATEGORY

Non Insulated  
Wire Ferrule

SCALE

4/1

PART #

N02505

SHEET

1-1

MATERIAL

Tin-Plated Copper

PAGE



FerrulesDirect

