

Notes:

1. Maximum Electric Current: 70A
2. Maximum Electric Rating: 105°C 600 Volts Max
3. Insulation Material: Nylon
4. Insulation Color: Brown
5. Terminal Material: Copper
6. Wire Range: 8 AWG (10.00mm²)

Standard (Metric)

L1: 0.93 (23.6mm)
L2: 0.59 (15.0mm)
D: 0.19 (4.9mm)
D1: 0.18 (4.5mm)
D2: 0.30 (7.6mm)

Tolerances

(Unless Otherwise Specified)

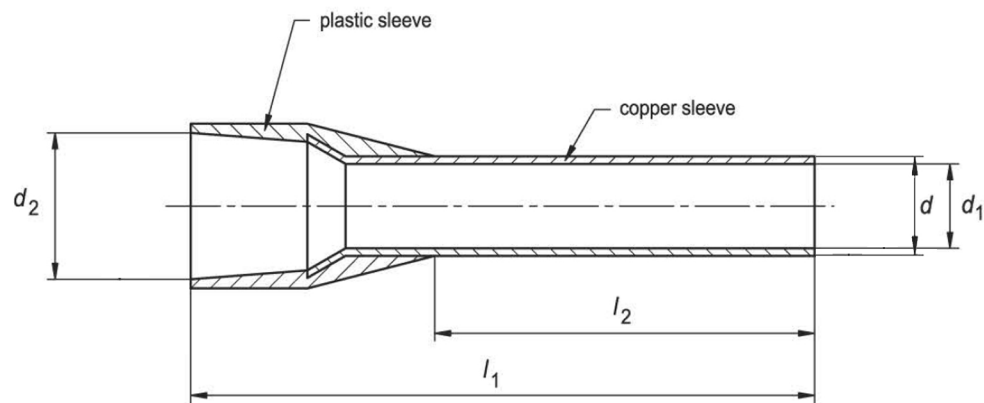

CATEGORY	Insulated Wire Ferrule	SCALE	4/1
PART #	AT100015	SHEET	1-1
MATERIAL	Tin-Plated Copper	PAGE	

