

Notes:

1. Maximum Electric Current: 195A
2. Maximum Electric Rating: 105°C 600 Volts Max
3. Insulation Material: Nylon
4. Insulation Color: Blue
5. Terminal Material: Copper
6. Wire Range: 1 AWG (50.00mm²)

Standard (Metric)

L1: 1.5 (38.0mm)
L2: 0.87 (22.0mm)
D: 0.343 (10.9mm)
D1: 0.41 (10.3mm)
D2: 0.59 (15.0mm)

Tolerances

(Unless Otherwise Specified)

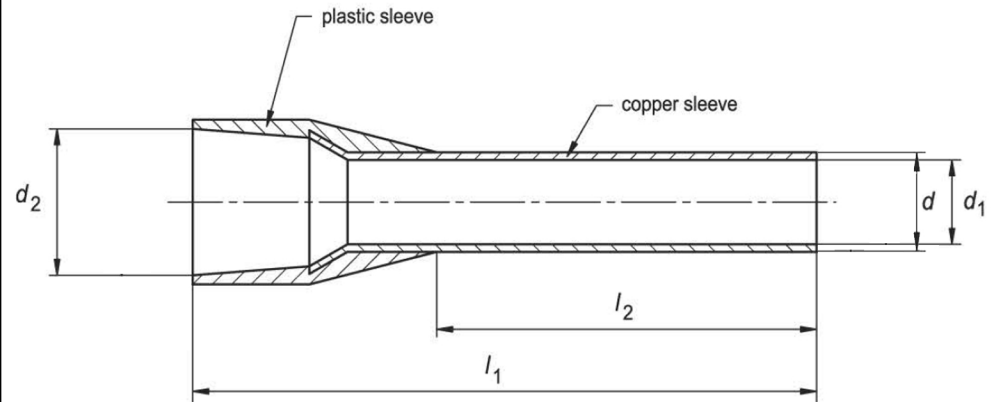

CATEGORY	Insulated Wire Ferrule	SCALE	4/1
PART #	AD500022	SHEET	1-1
MATERIAL	Tin-Plated Copper	PAGE	



FerrulesDirect

