

# LUMINA

## Installation manual

Dimensions:  
120x180 cm  
150x180 cm  
150x200 cm

Handedness:  
Right



# Leave space for better assembly

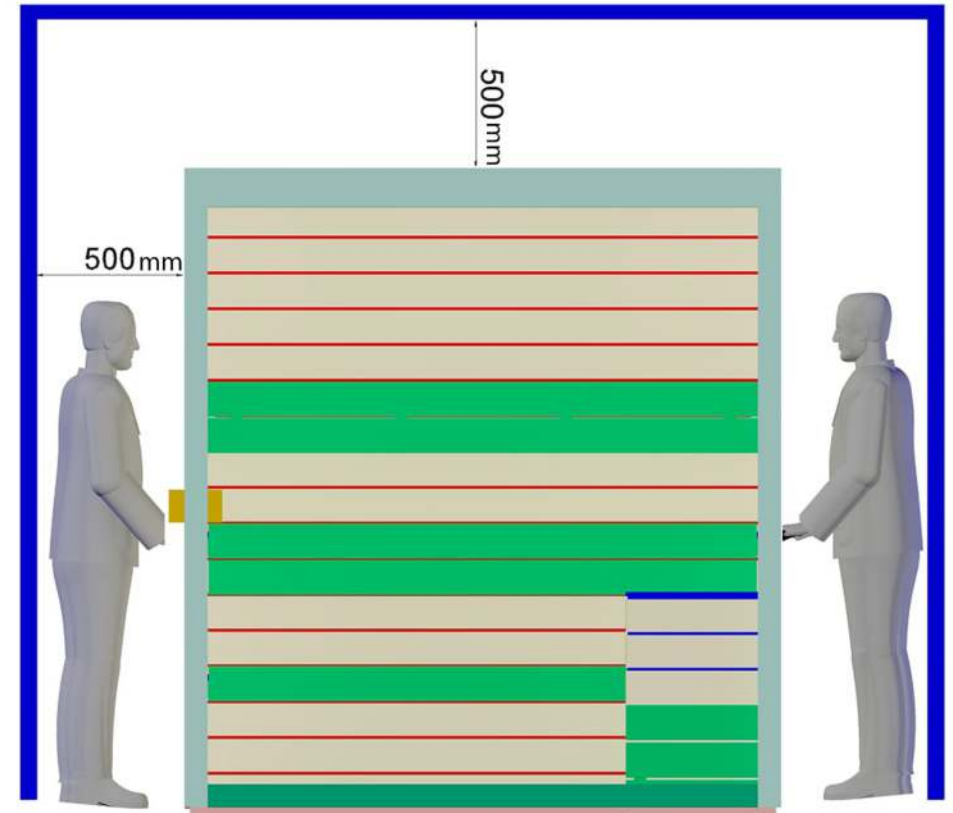
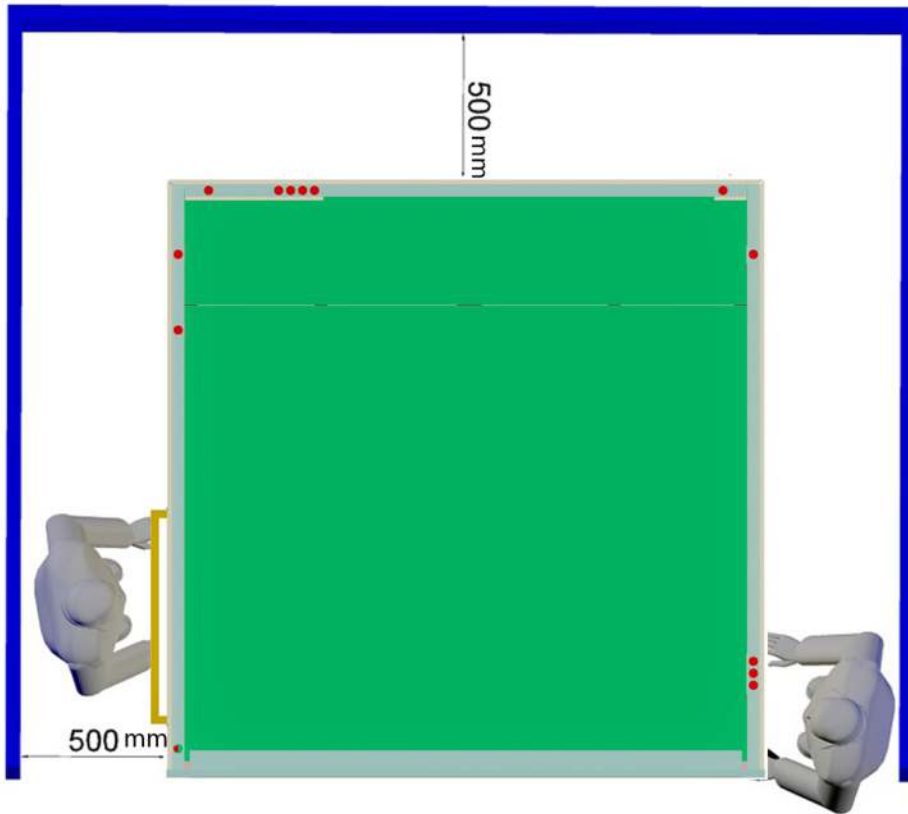

# Tools

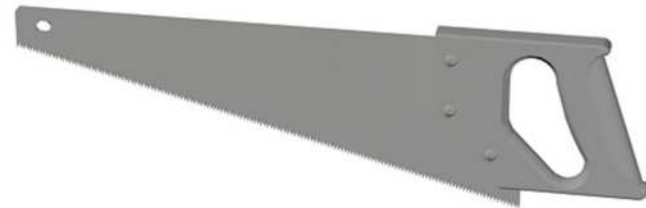

# 1. Base frame

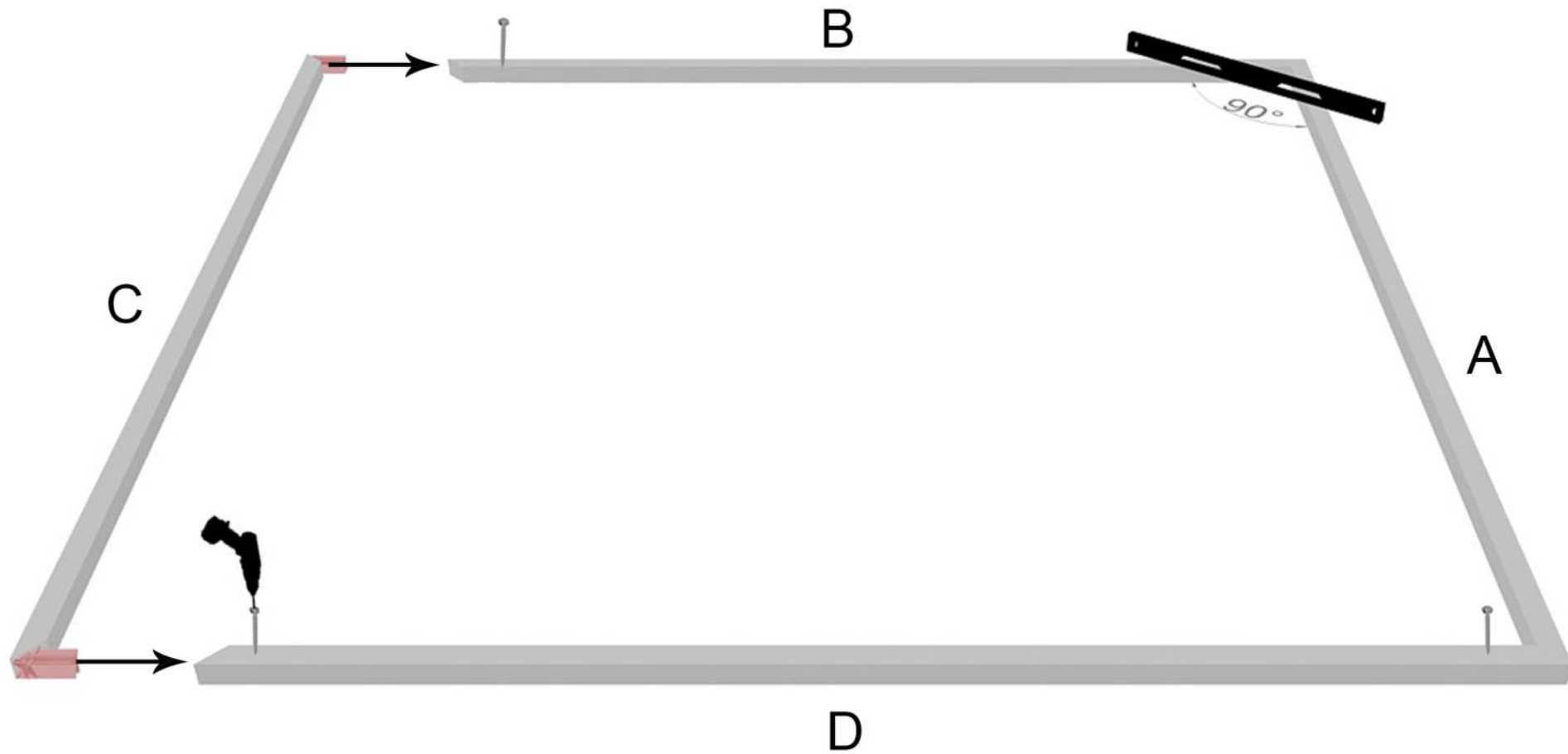

	A/C (mm)	B/D (mm)
120x180 cm	1178	1770
150x180 cm	1478	1770
150x200 cm	1478	1970

## 2. Walls

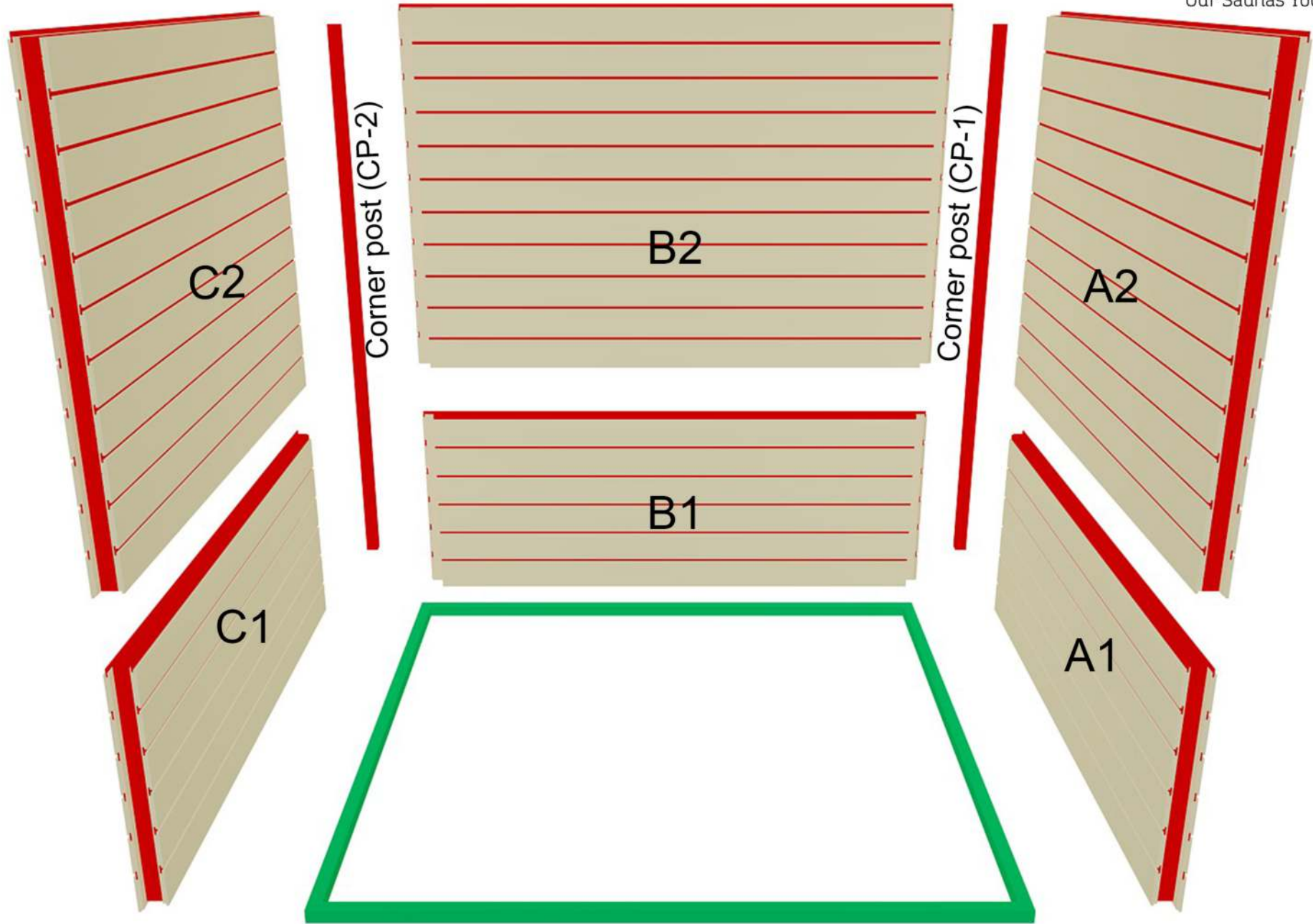

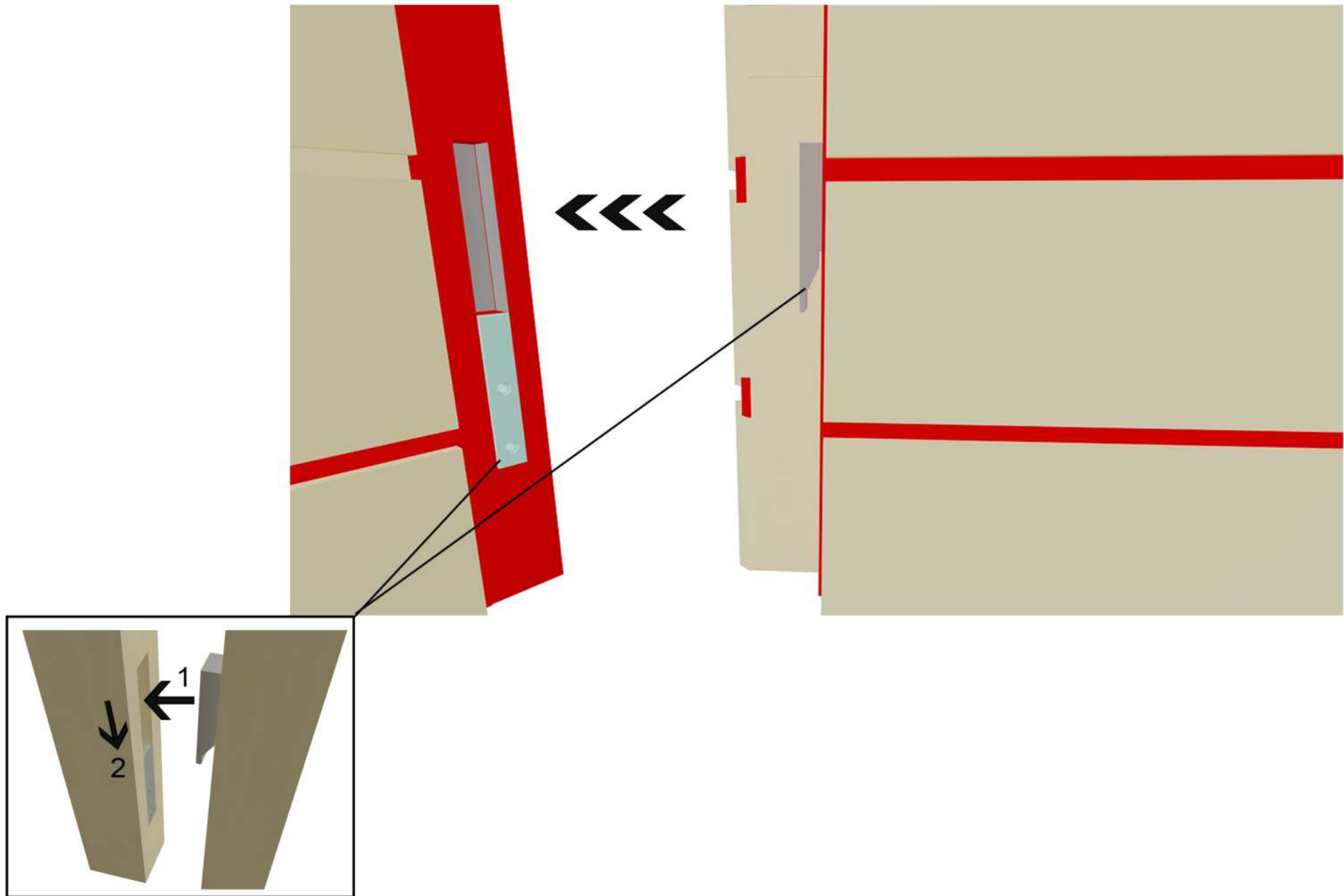

### 3. Multiclip closing system

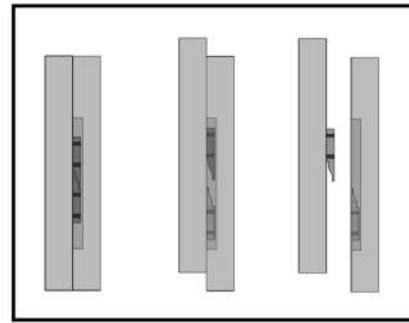
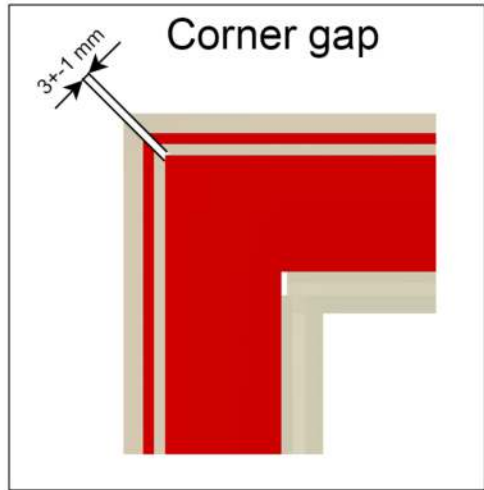

# 4. Fixing walls A1 & B1

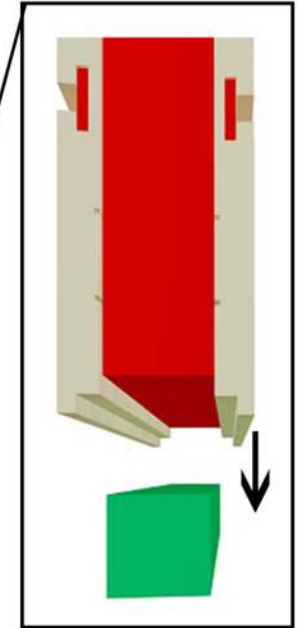
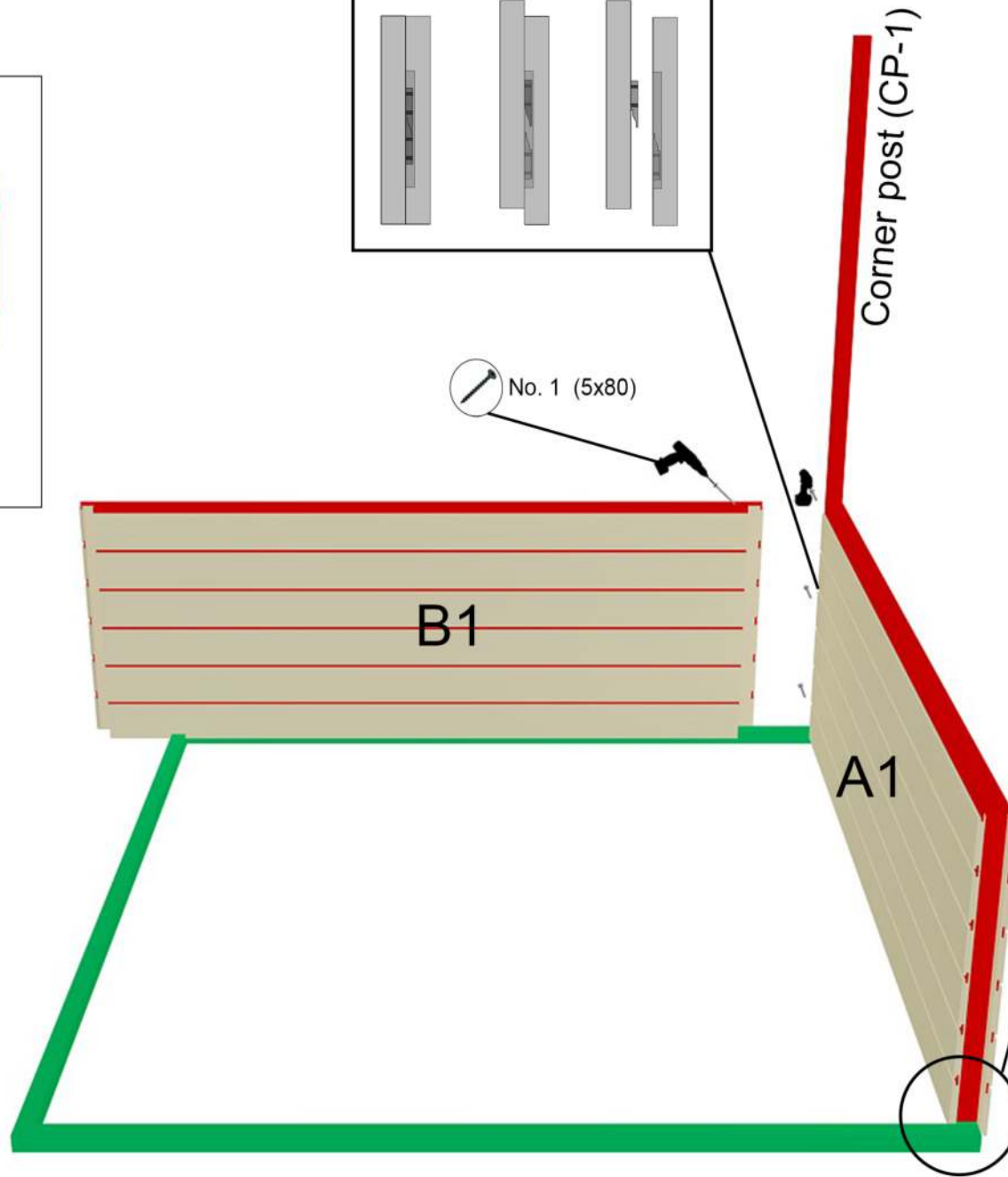

No. 1 (5x80)



# 5. Fixing wall A2 & B2

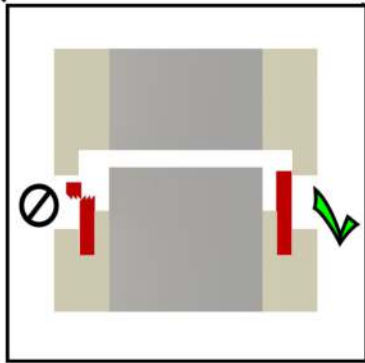
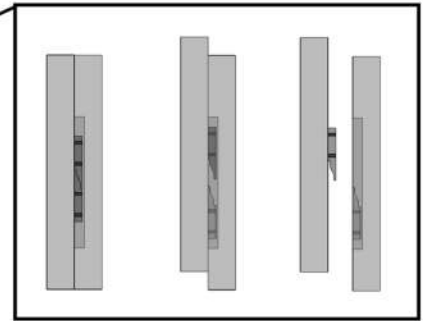
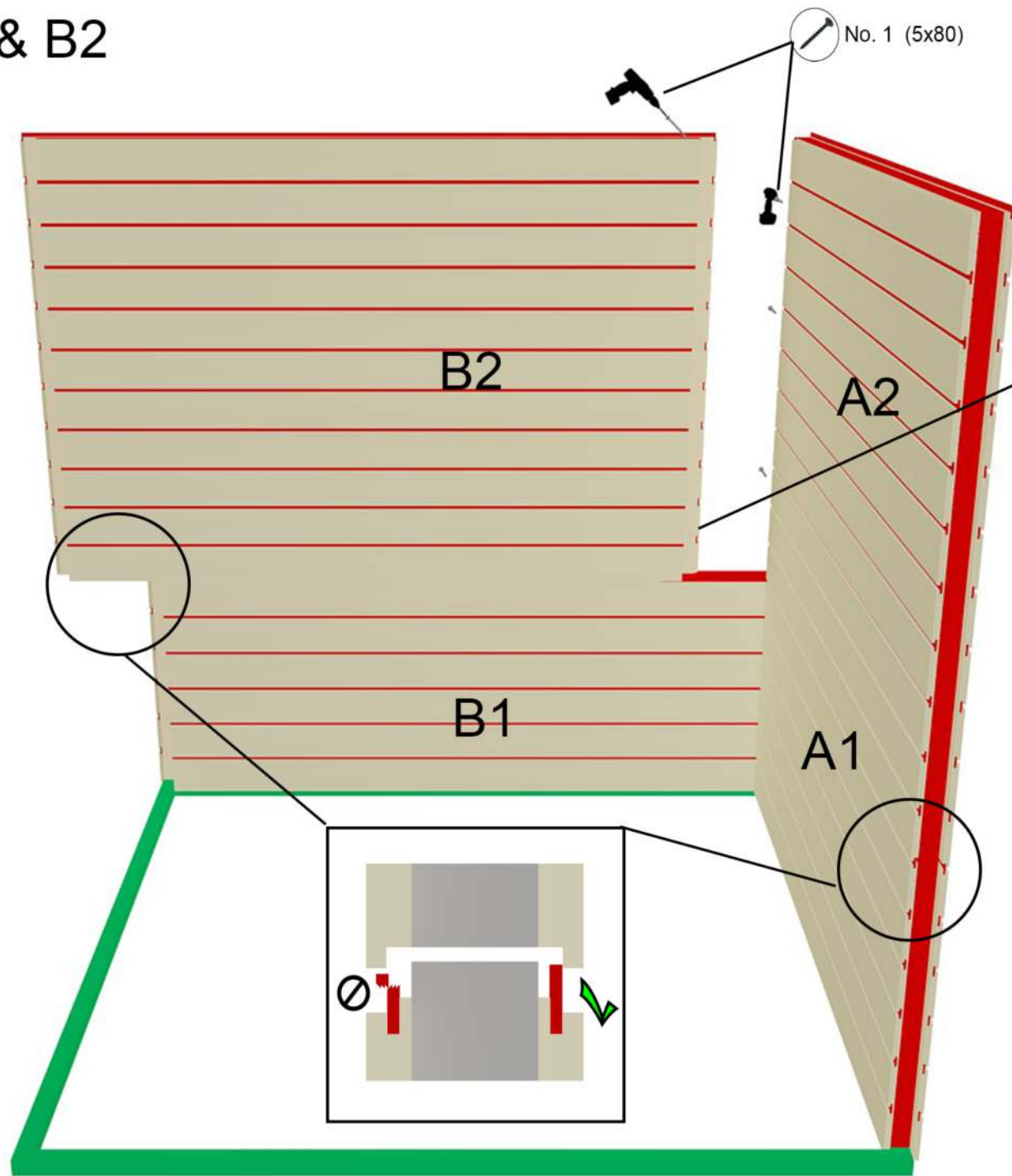
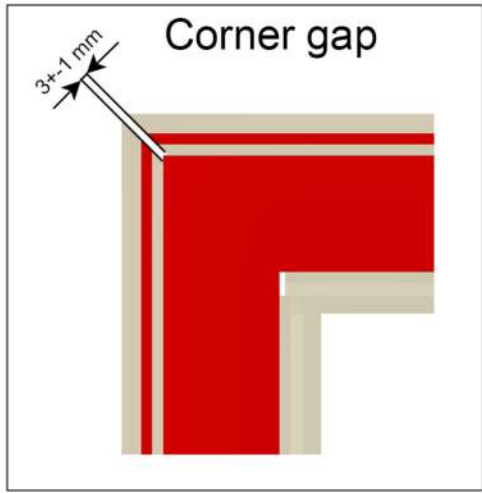



## 6. Fixing corner post

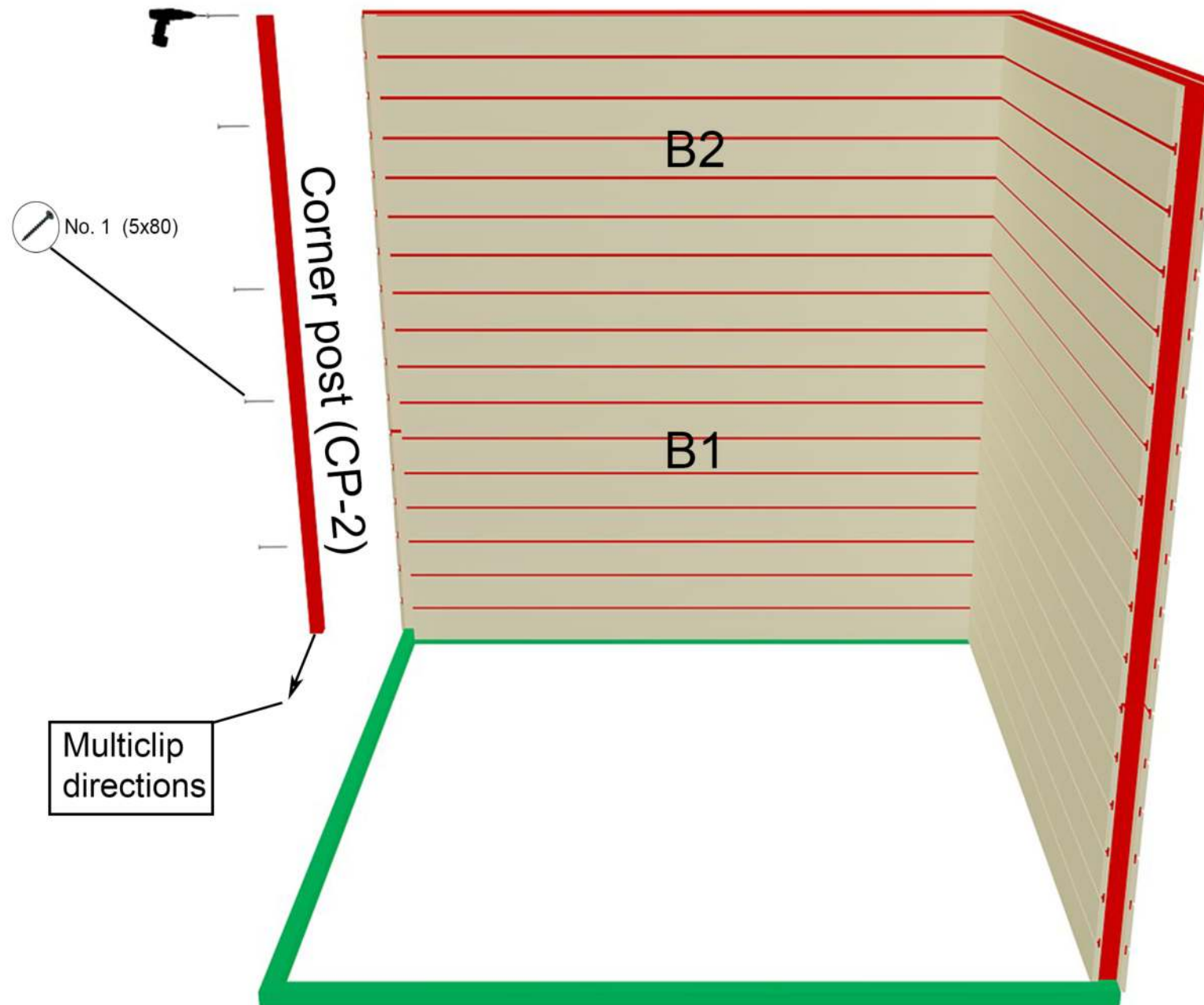

# 7. Fixing walls C1&C2

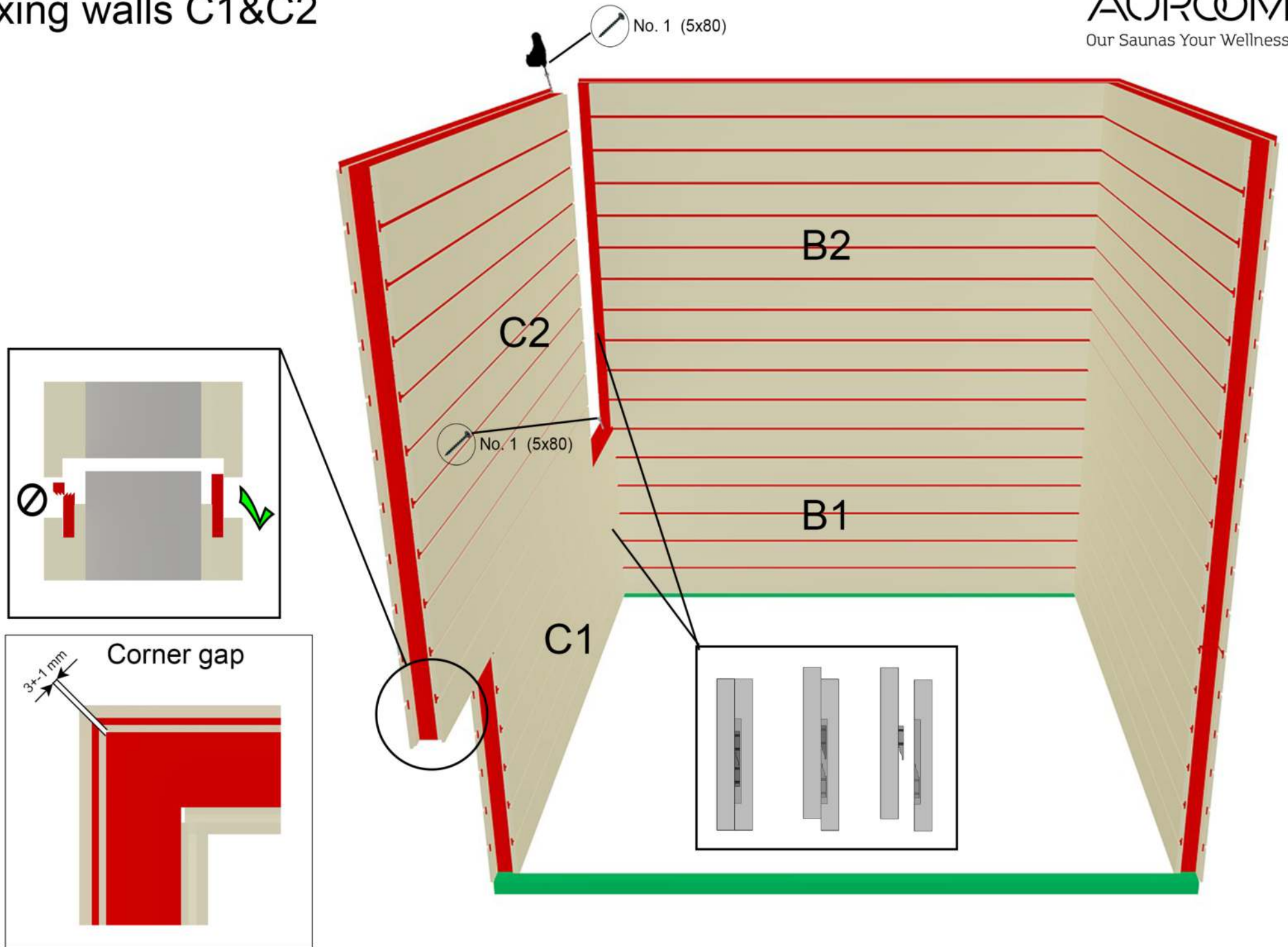

# 8. Fixing ceilings

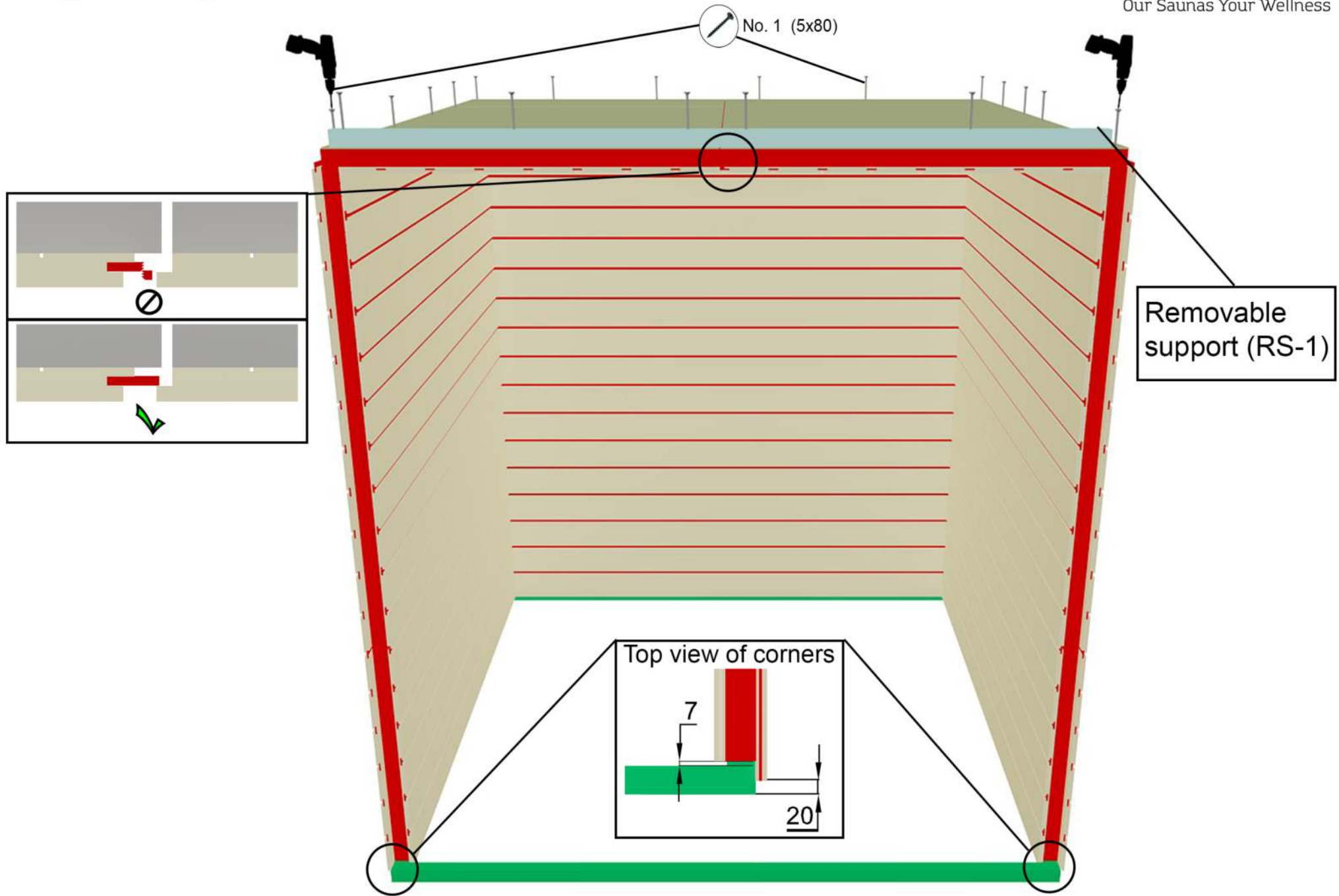

## 9. Wiring inside walls

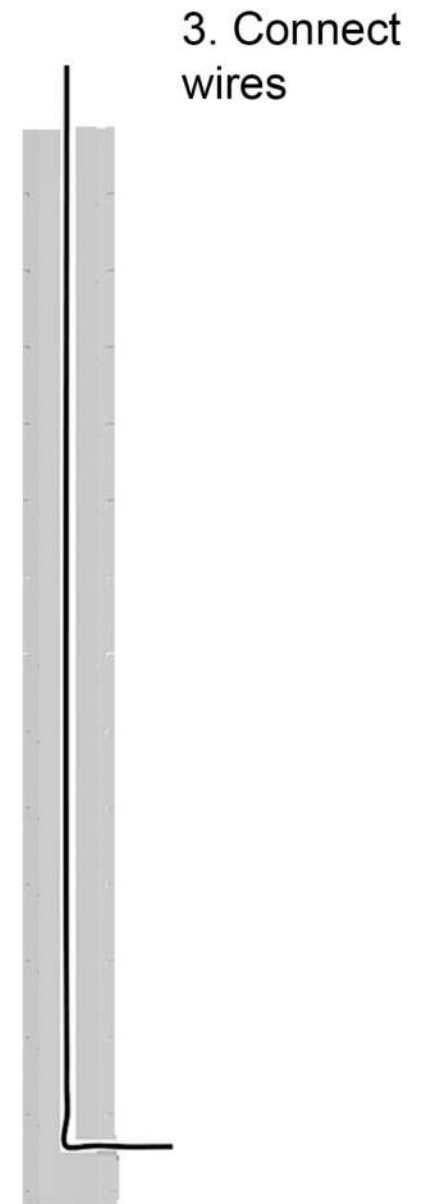
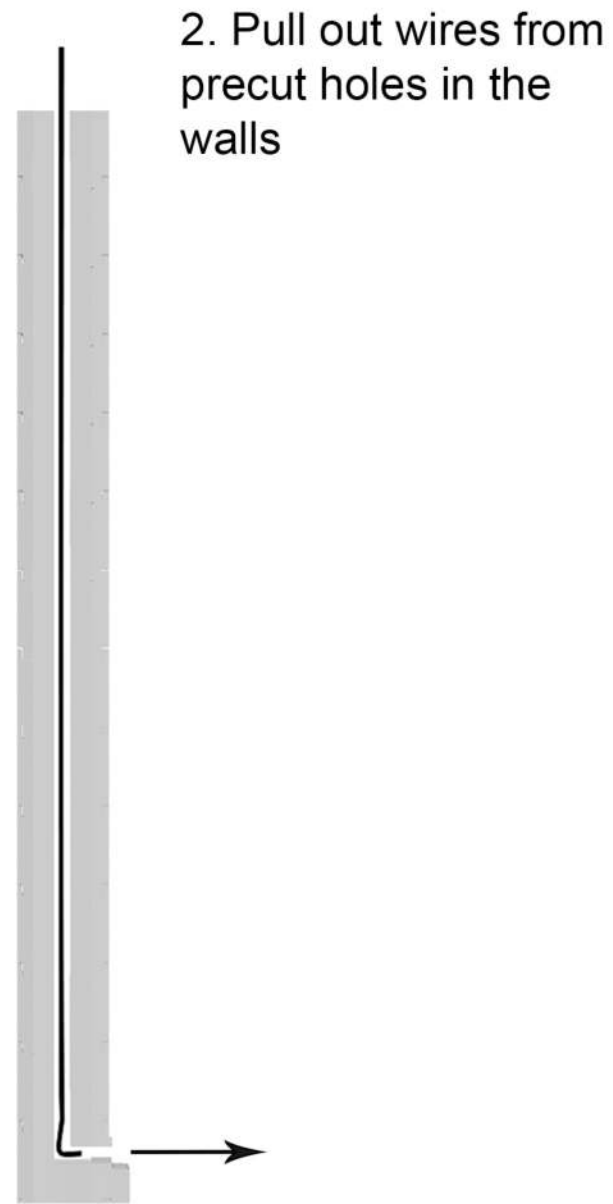
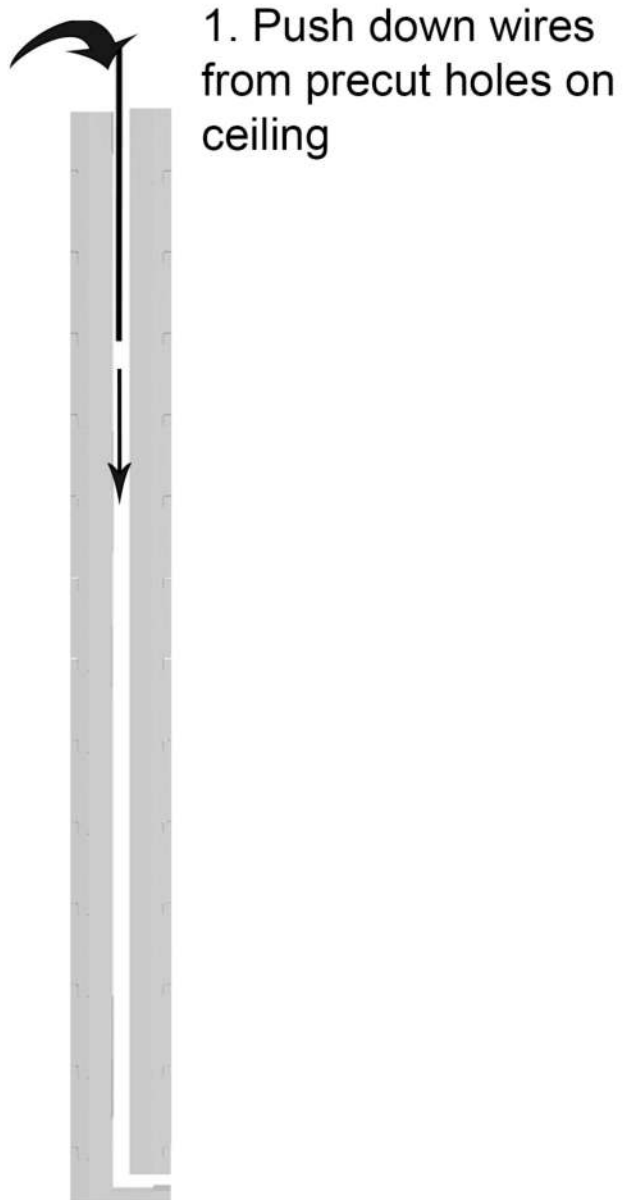

# 10. Interior

120x180 cm

150x180 cm

150x200 cm

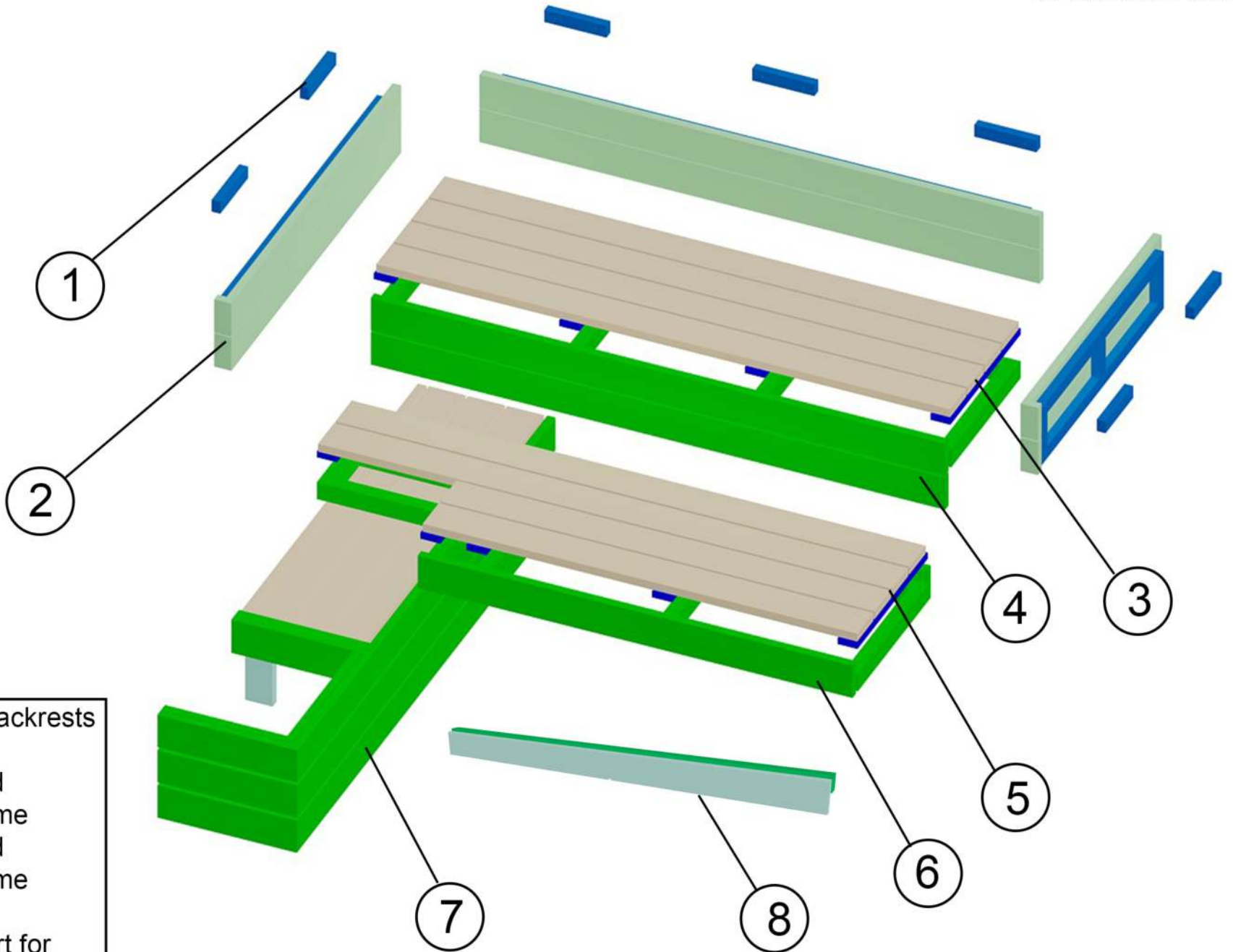

- 1. Block for fixing backrests
- 2. Backrests
- 3. Upper bench grid
- 4. Upper bench frame
- 5. Lower bench grid
- 6. Lower bench frame
- 7. Platform
- 8. Additional support for model 120x180 cm

# 10.1 Assembly of platform

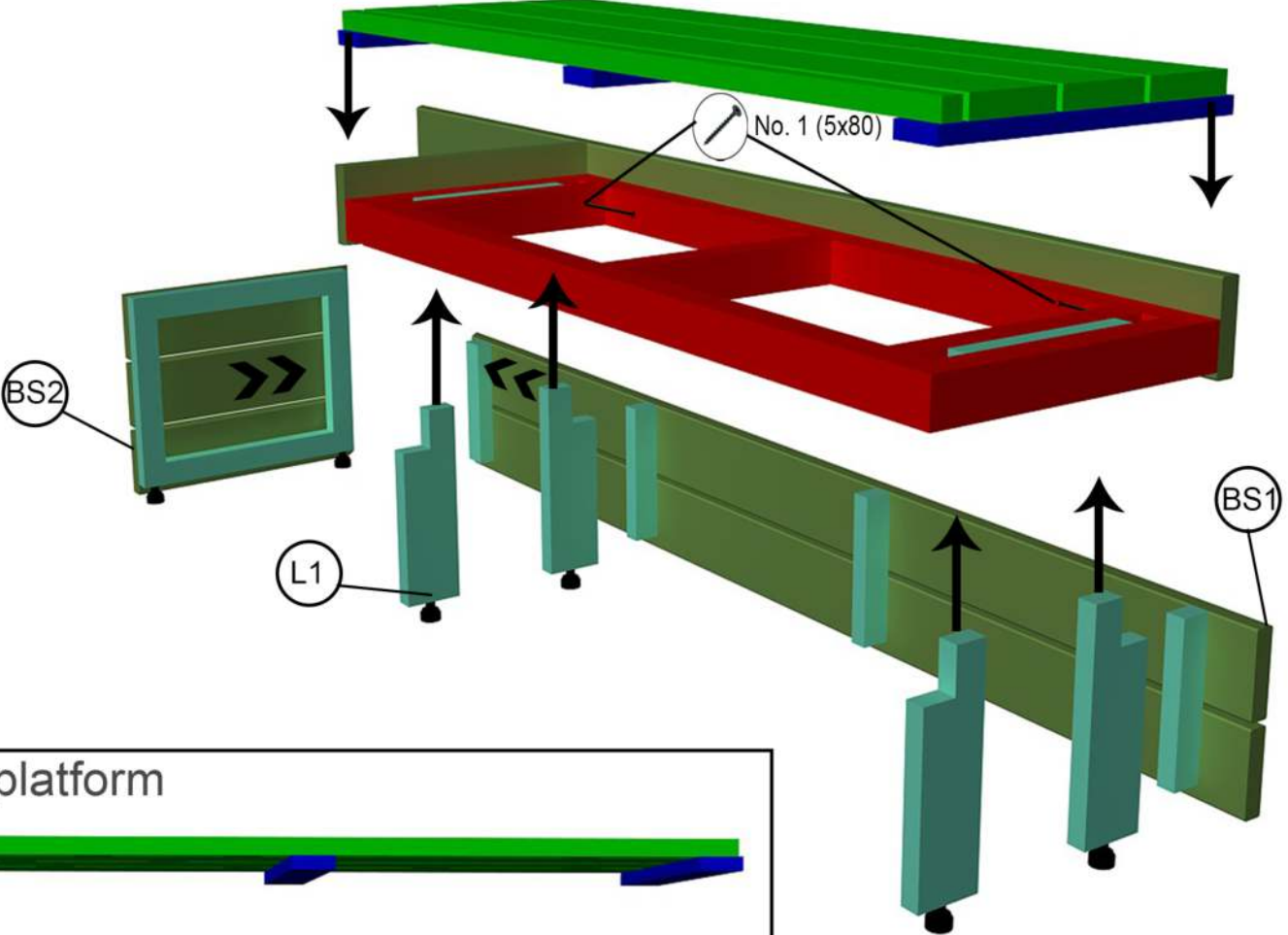

## Fixing platform

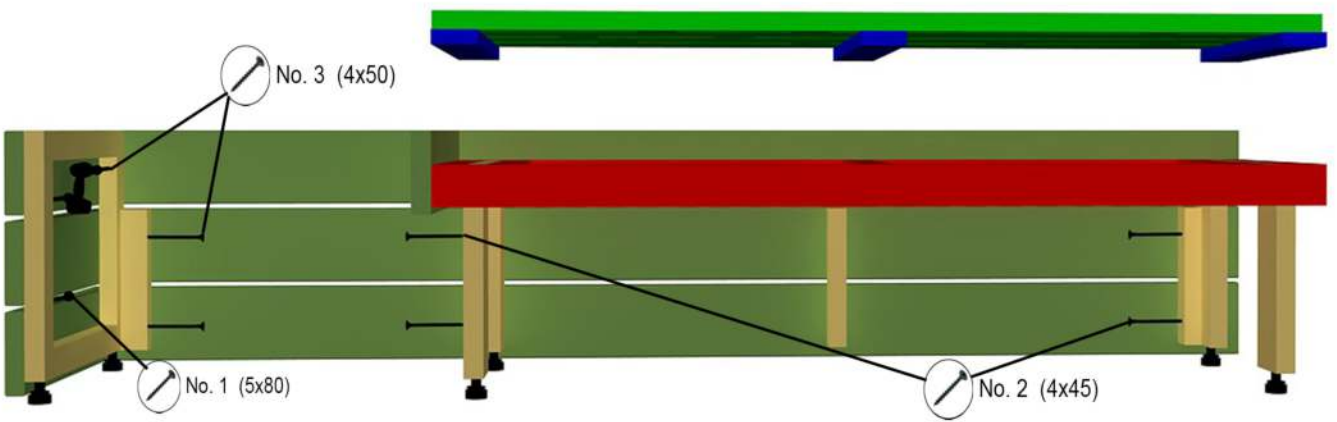

## 10.2 Upper bench frame & blocks for backrest

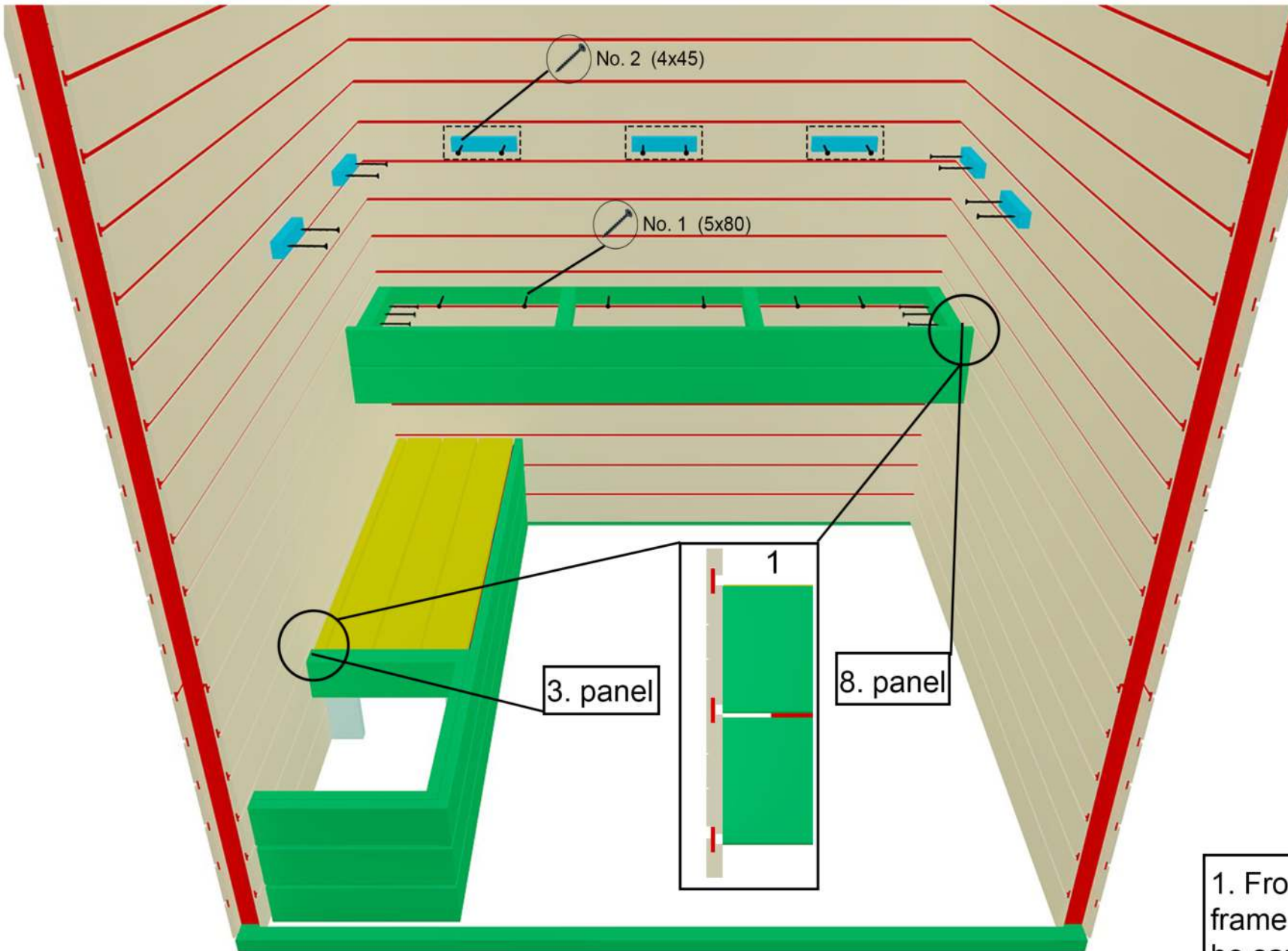

1. Frontside of the bench frame & platform have to be same level with paneling as shown

## 10.3 Cariitti optic fibre for upper bench (Optional)

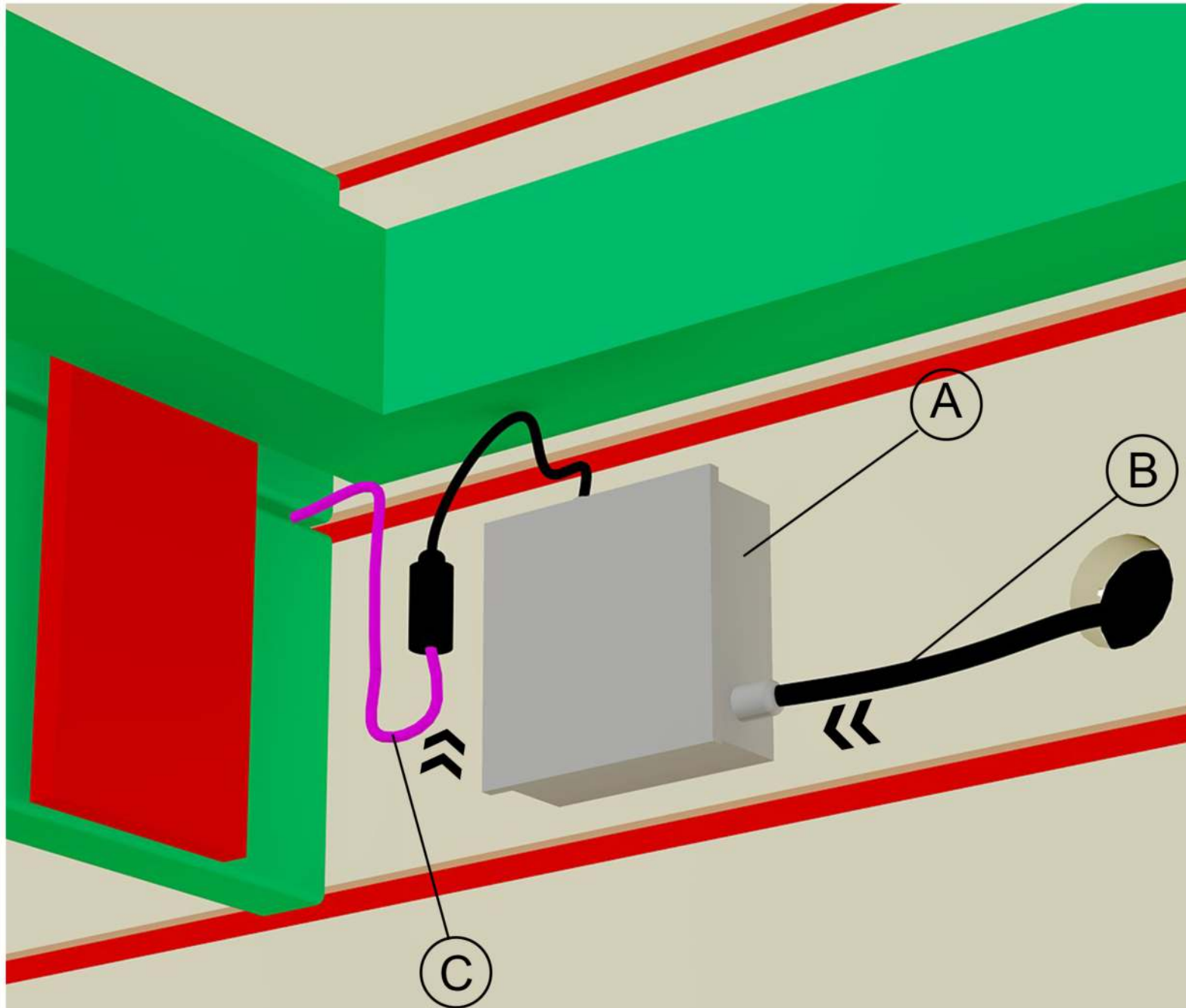

- A. Projector
- B. Power cable
- C. Fibre

1. Push down power cable from the ceiling
2. Connect power cable with projector
3. Push fiber in gap between upper bench frontboards
4. Connect fibre with projector



# 10.4 Lower bench frame fixing

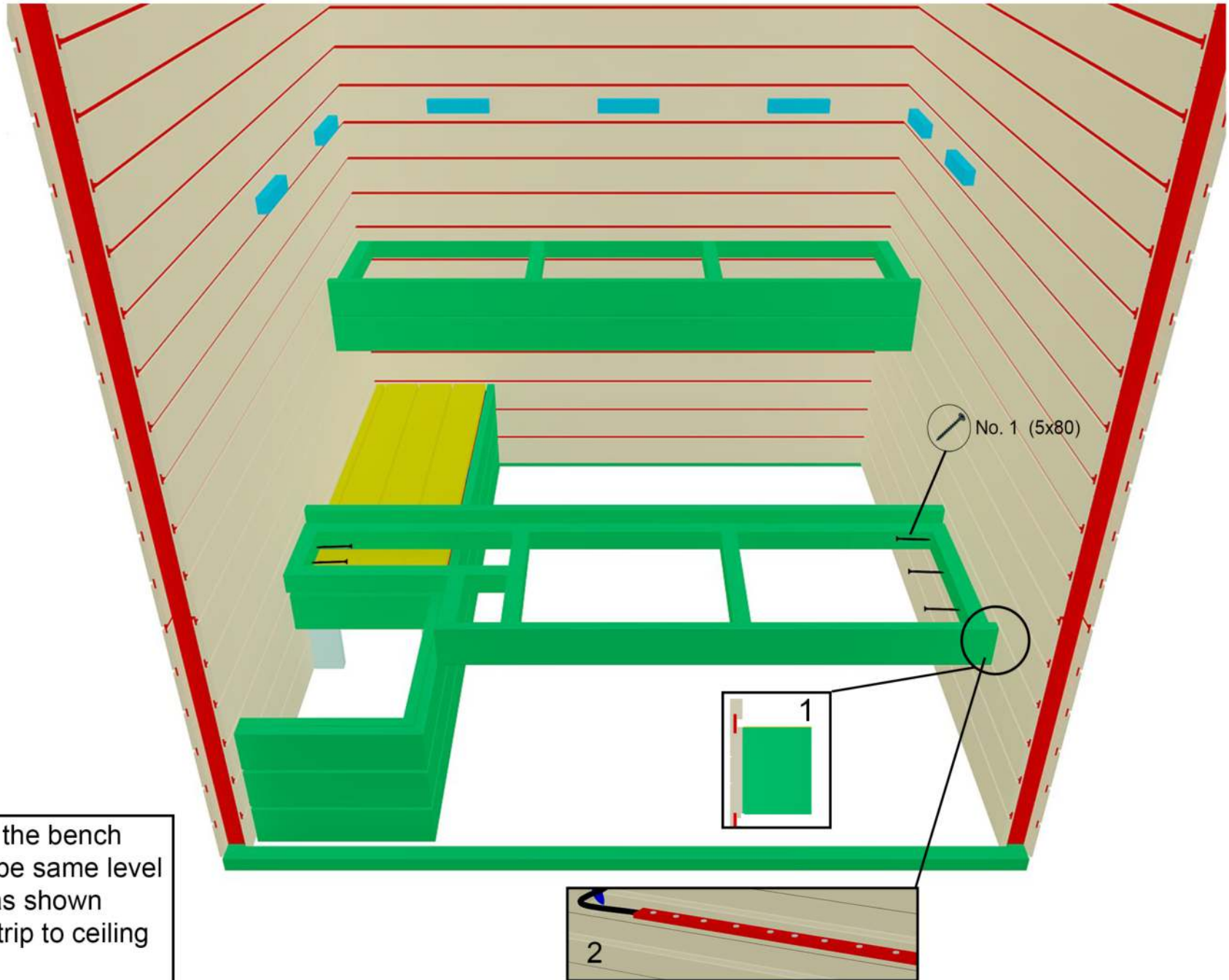

- 1. Frontside of the bench frame have to be same level with paneling as shown
- 2. Push LED-strip to ceiling for connection

# 10.5 Additional support fixing 120x180 cm

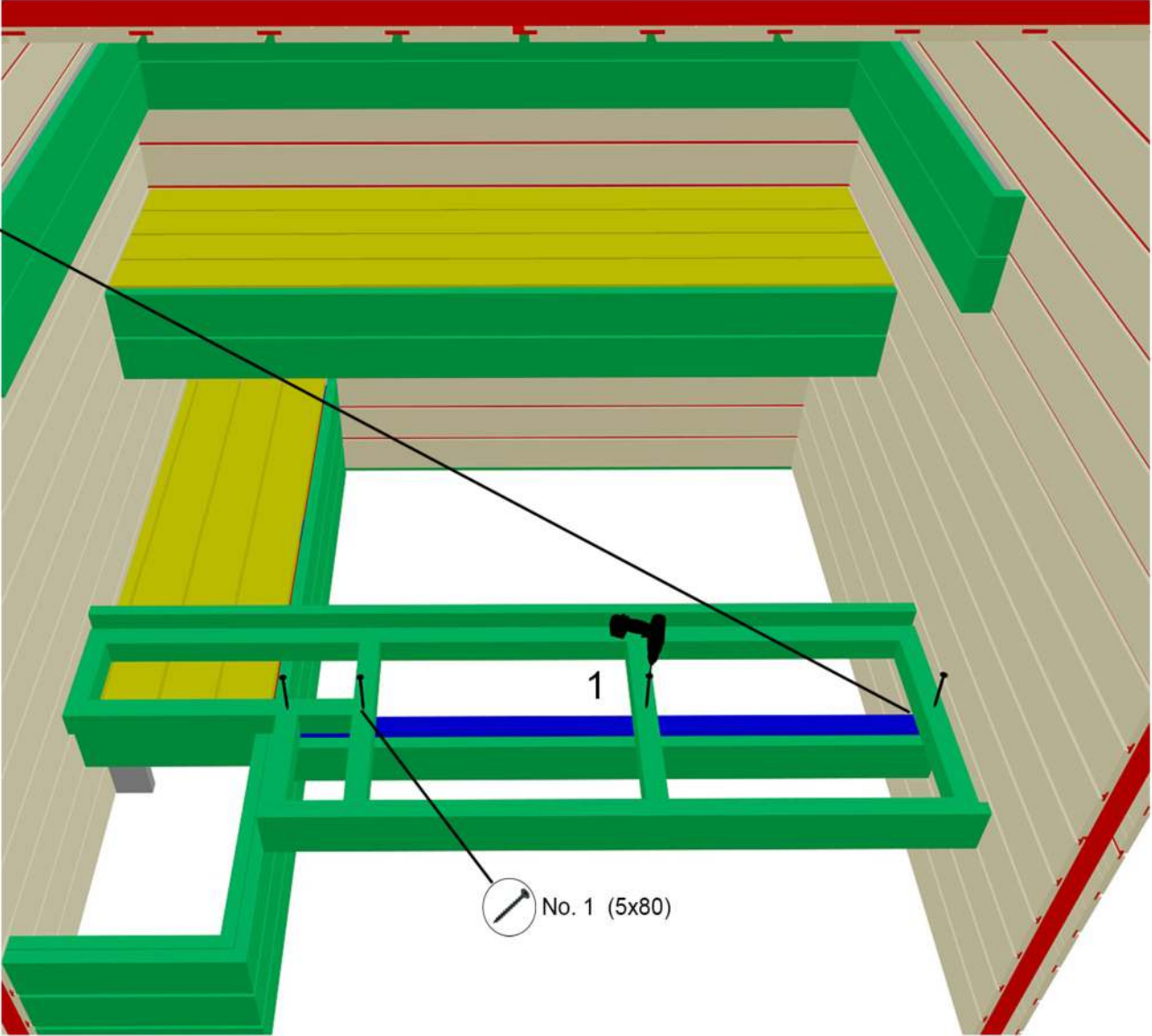
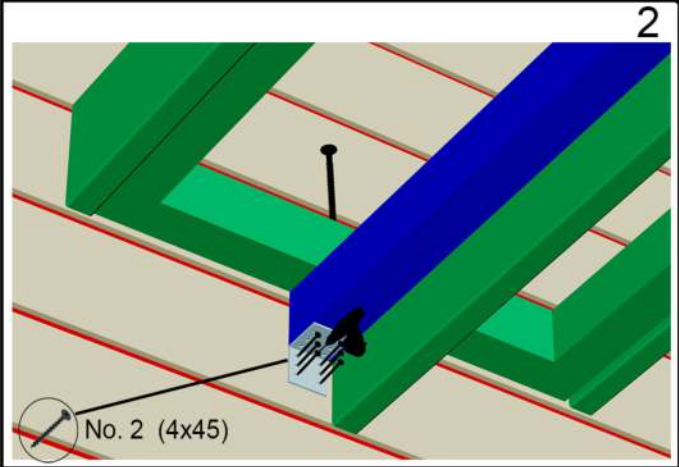

# 11. Backrest LED-strips

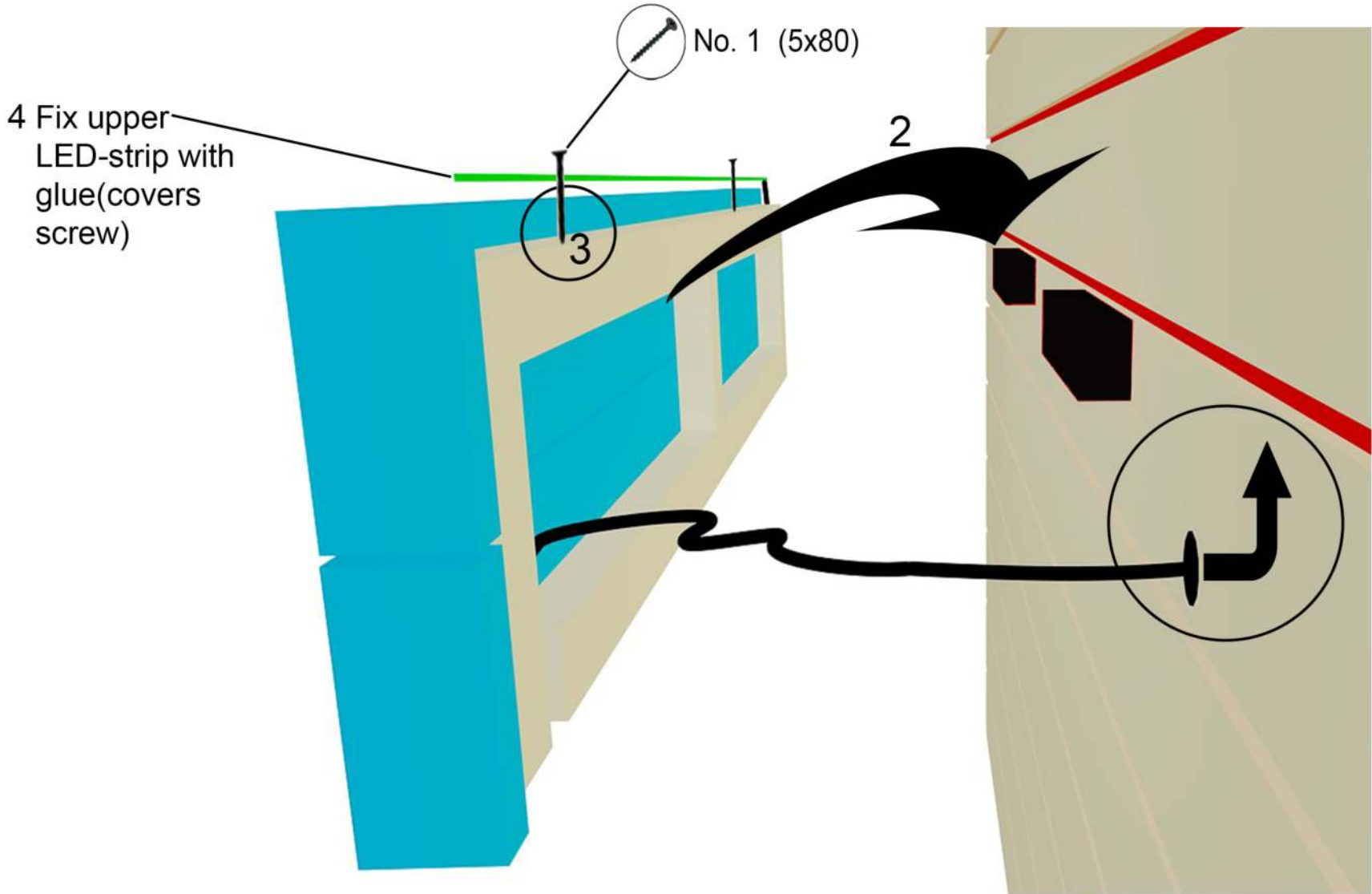

# 11.1 Fixing backrests

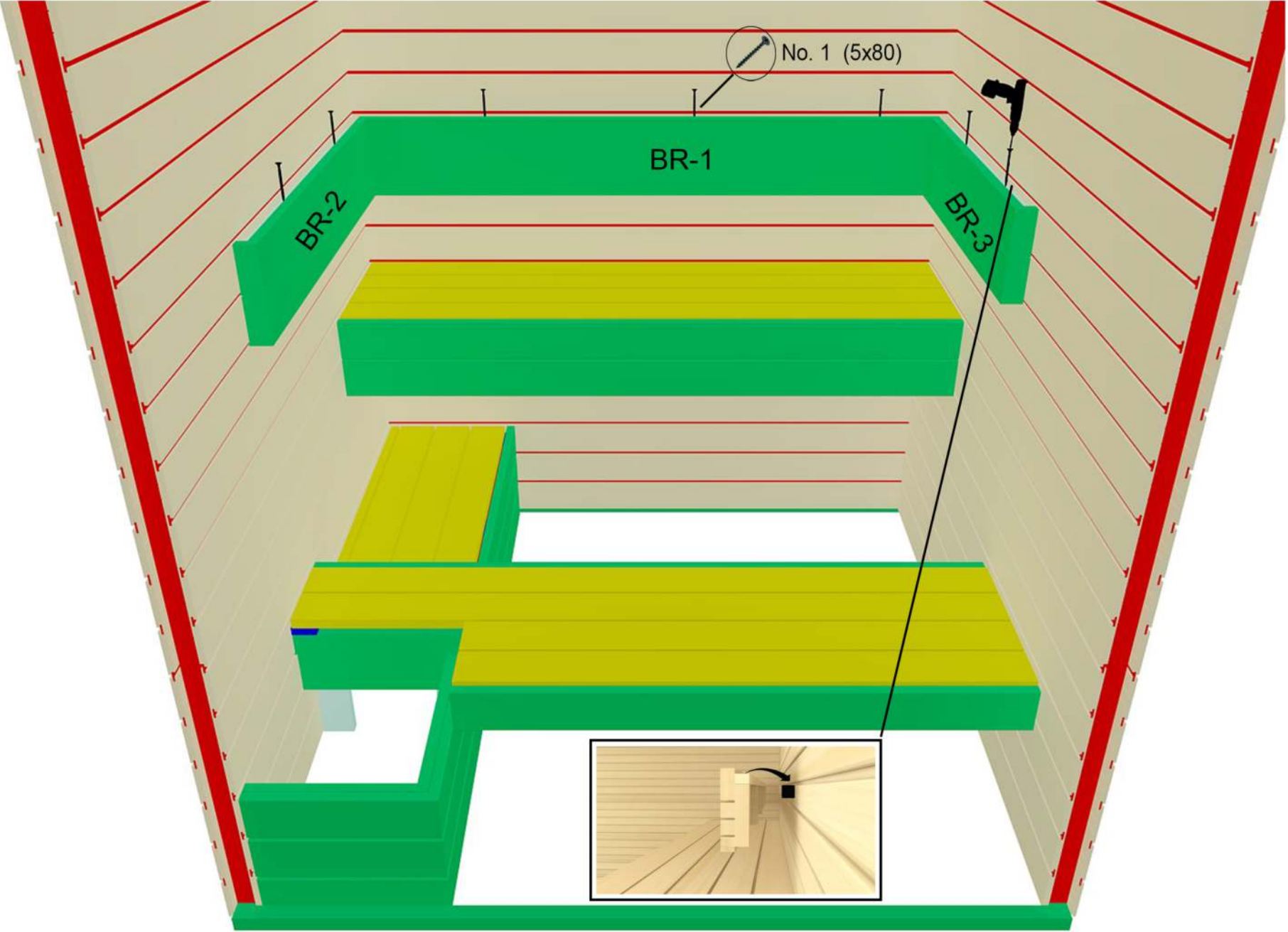

## 12. Interior II

120x180 cm

150x180 cm

150x200 cm

AUROOM

Our Saunas Your Wellness

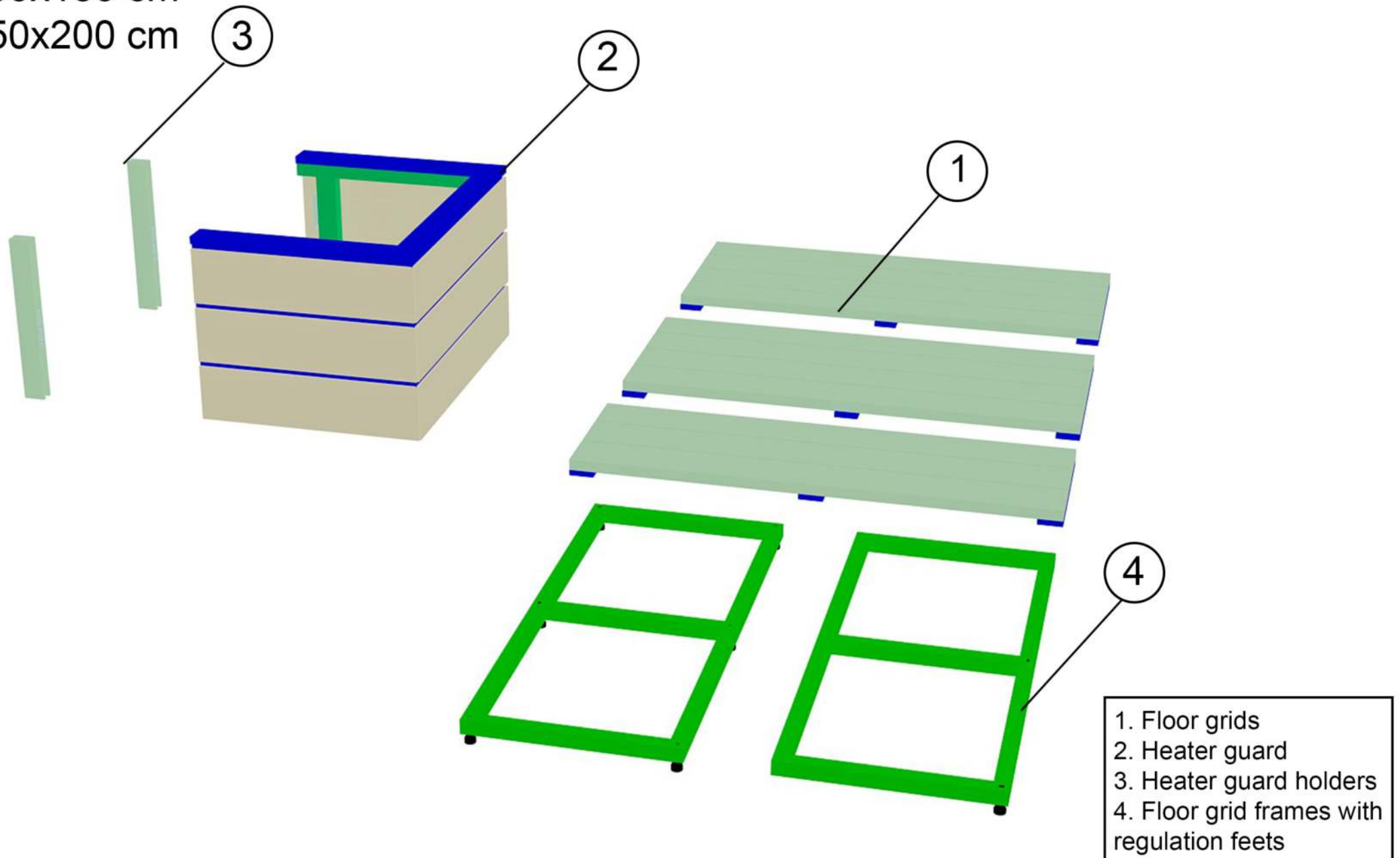

# 13. Fixing heater guard

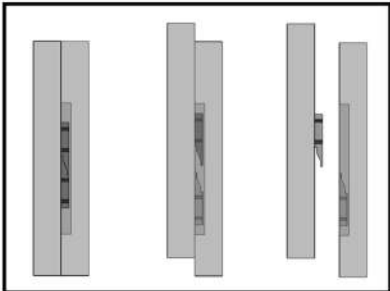

No. 2 (4x45)

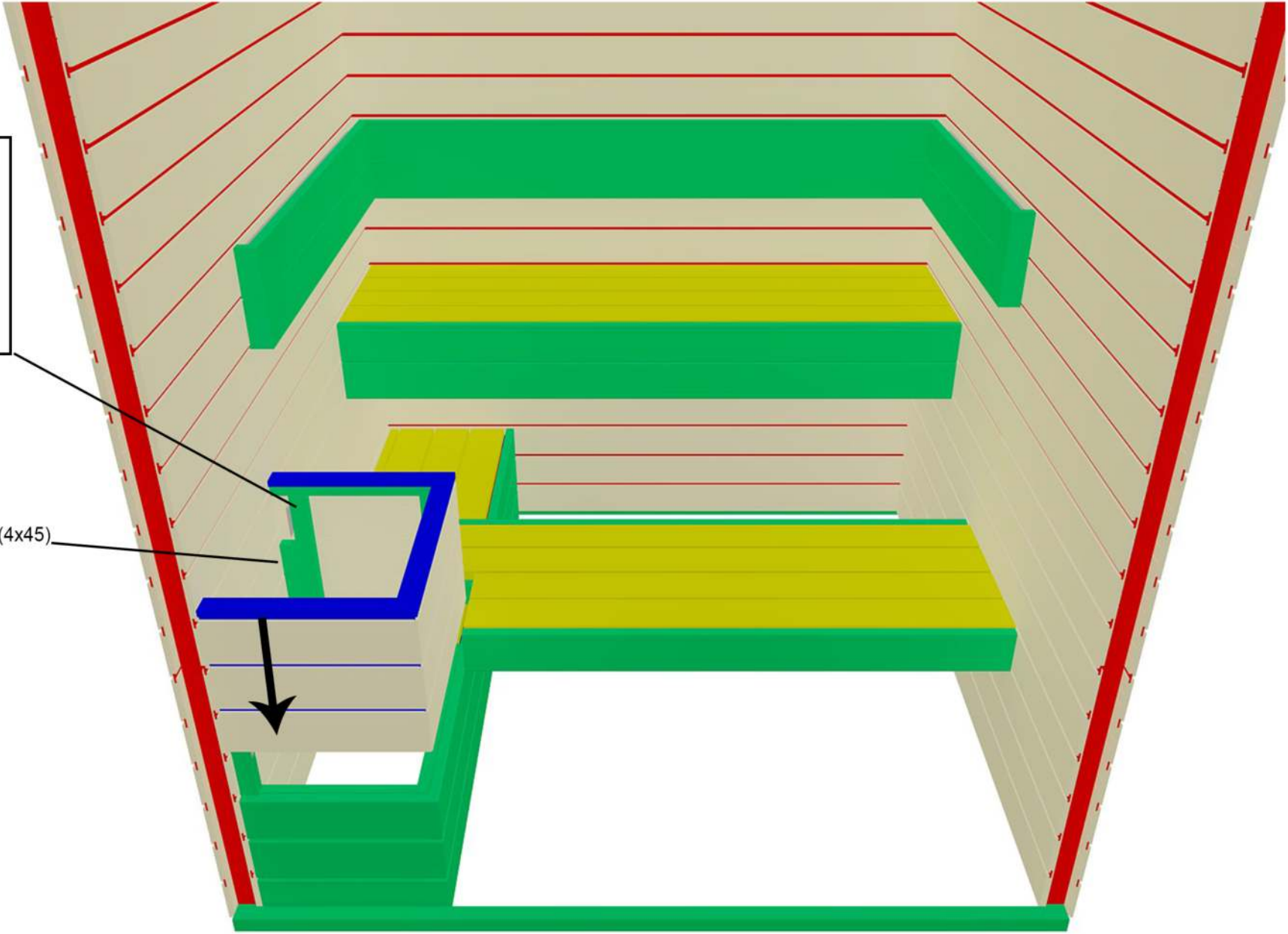

# 14. Glass wall & door frames

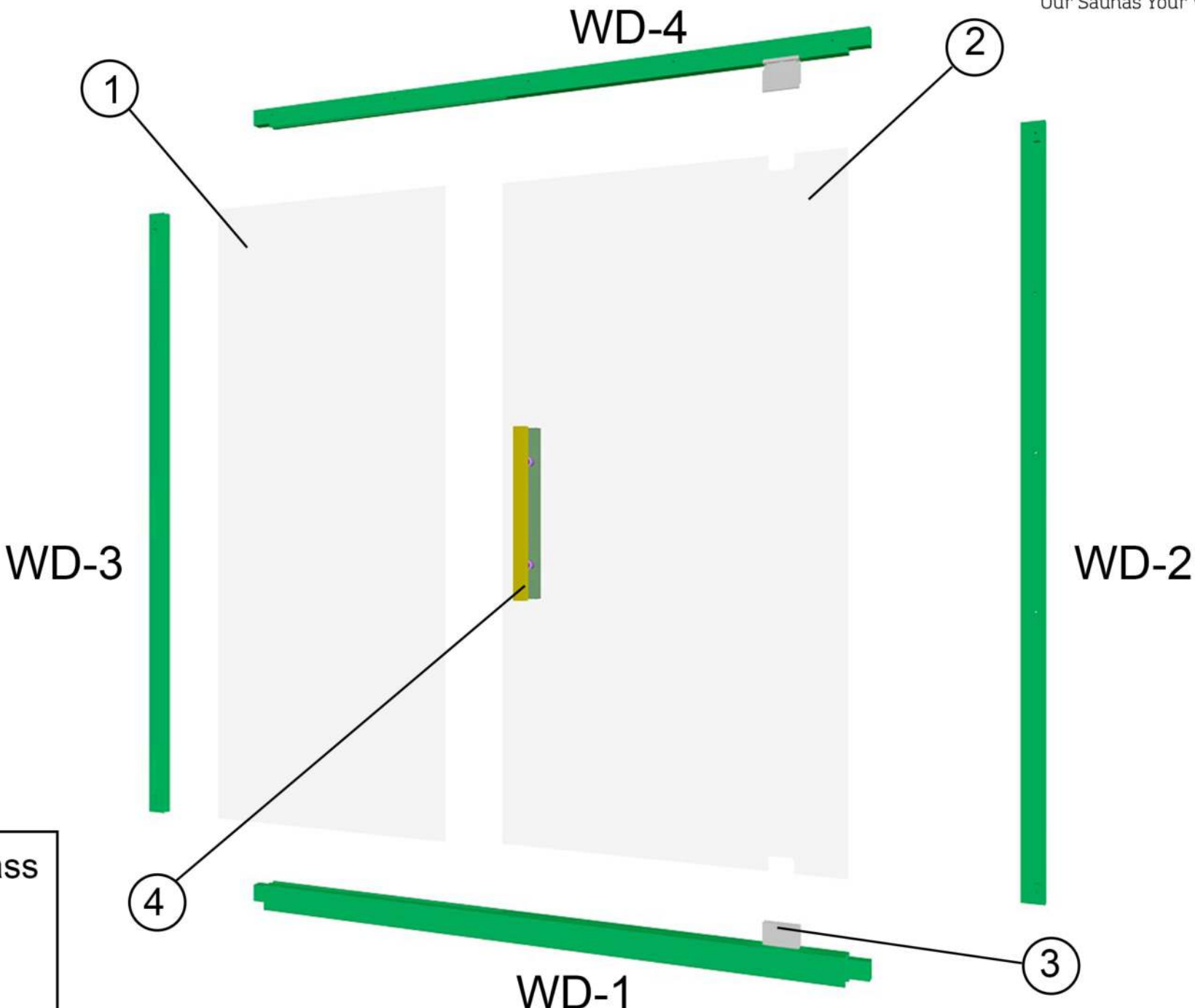

- 1. Glass wall glass
- 2. Door glass
- 3. Door hinge
- 4. Door handle

# 15. Fixing glass wall & door frames

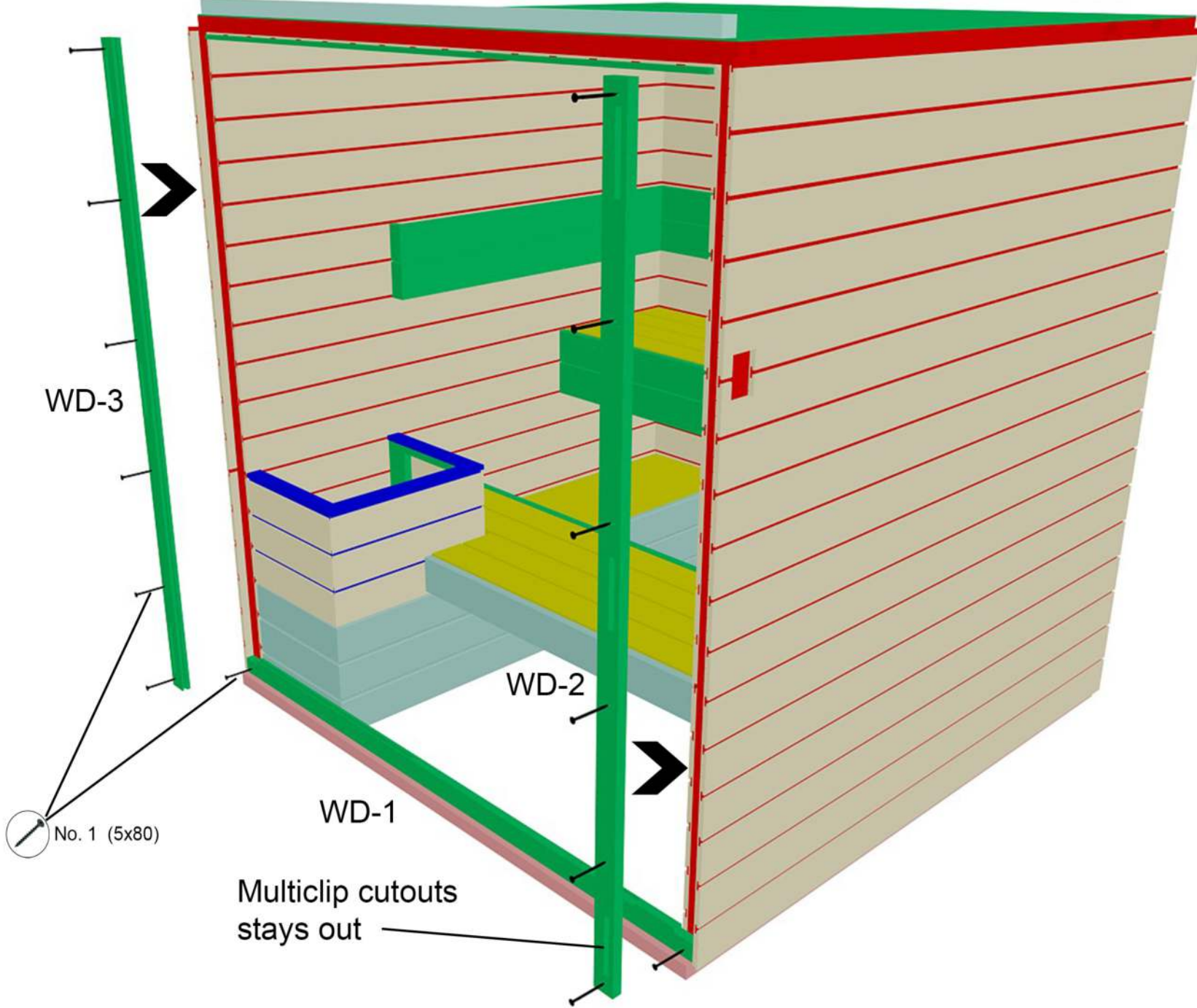



# 15.1 Fixing glass wall

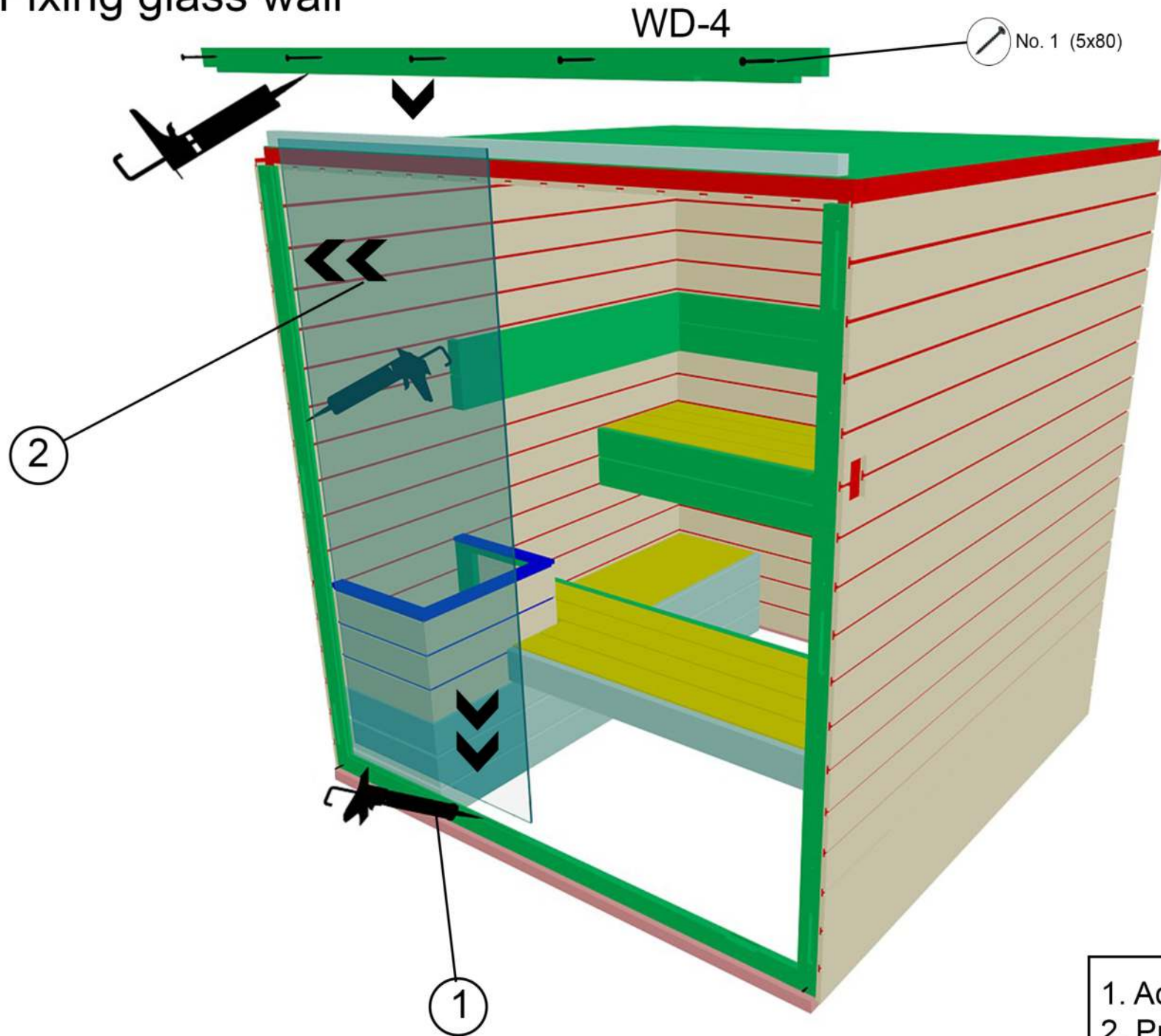

- 1. Add glue in u-profile
- 2. Push glass in u-profile

# 15.2 Multiclips for frames



RS-1

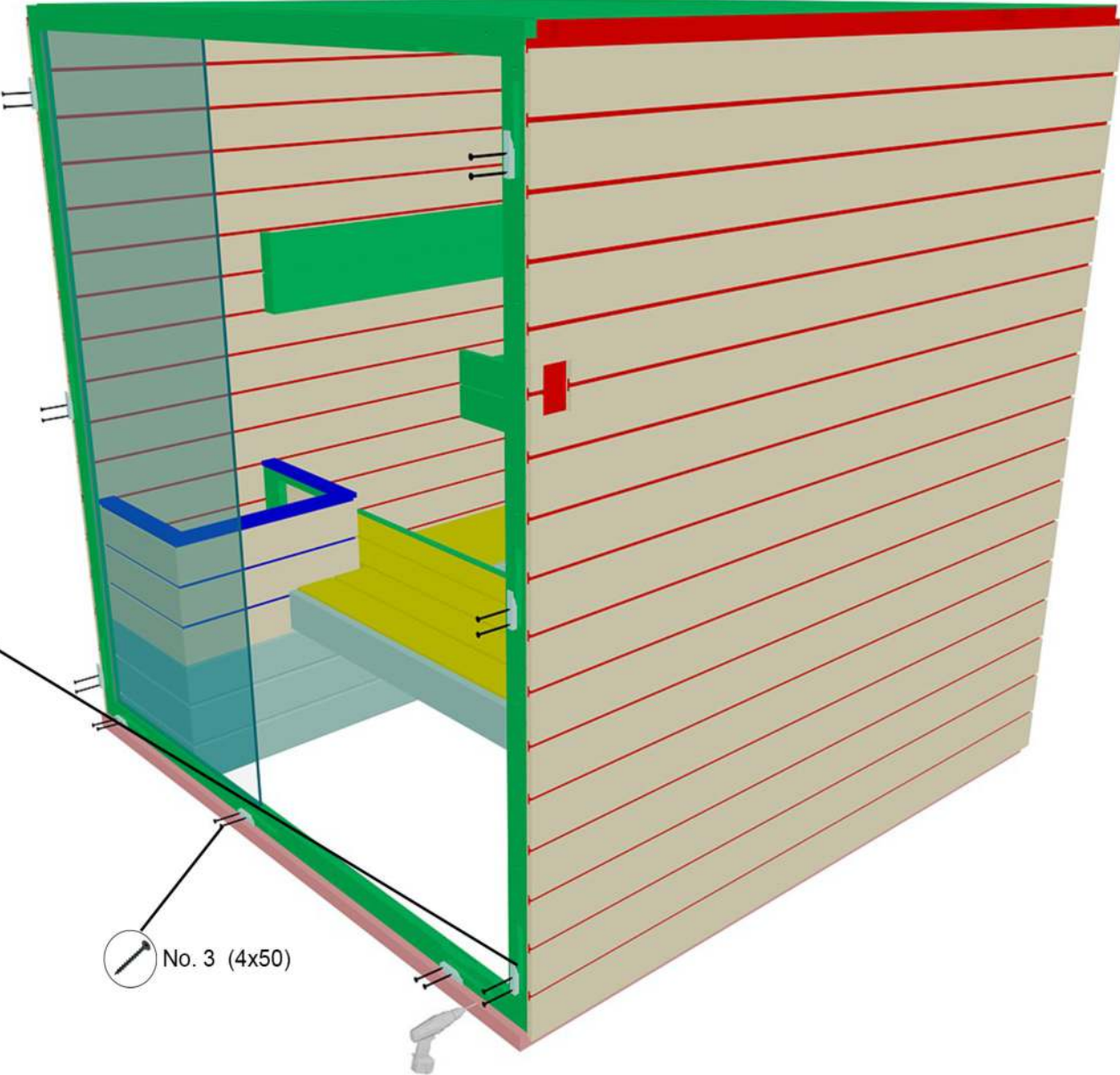
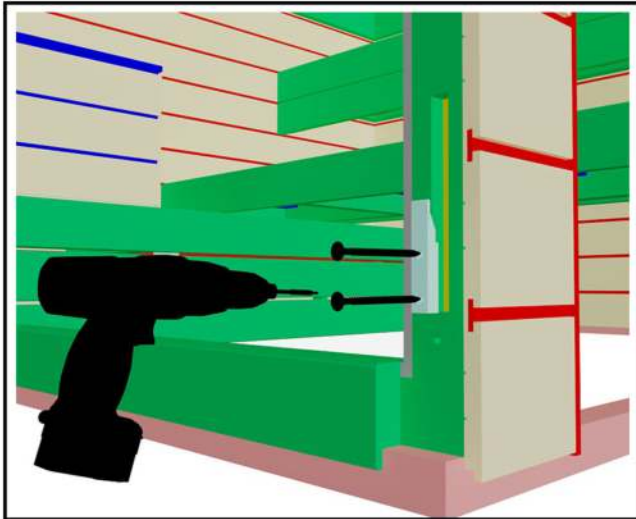

No. 3 (4x50)

## 15.3 Door hinges and glass

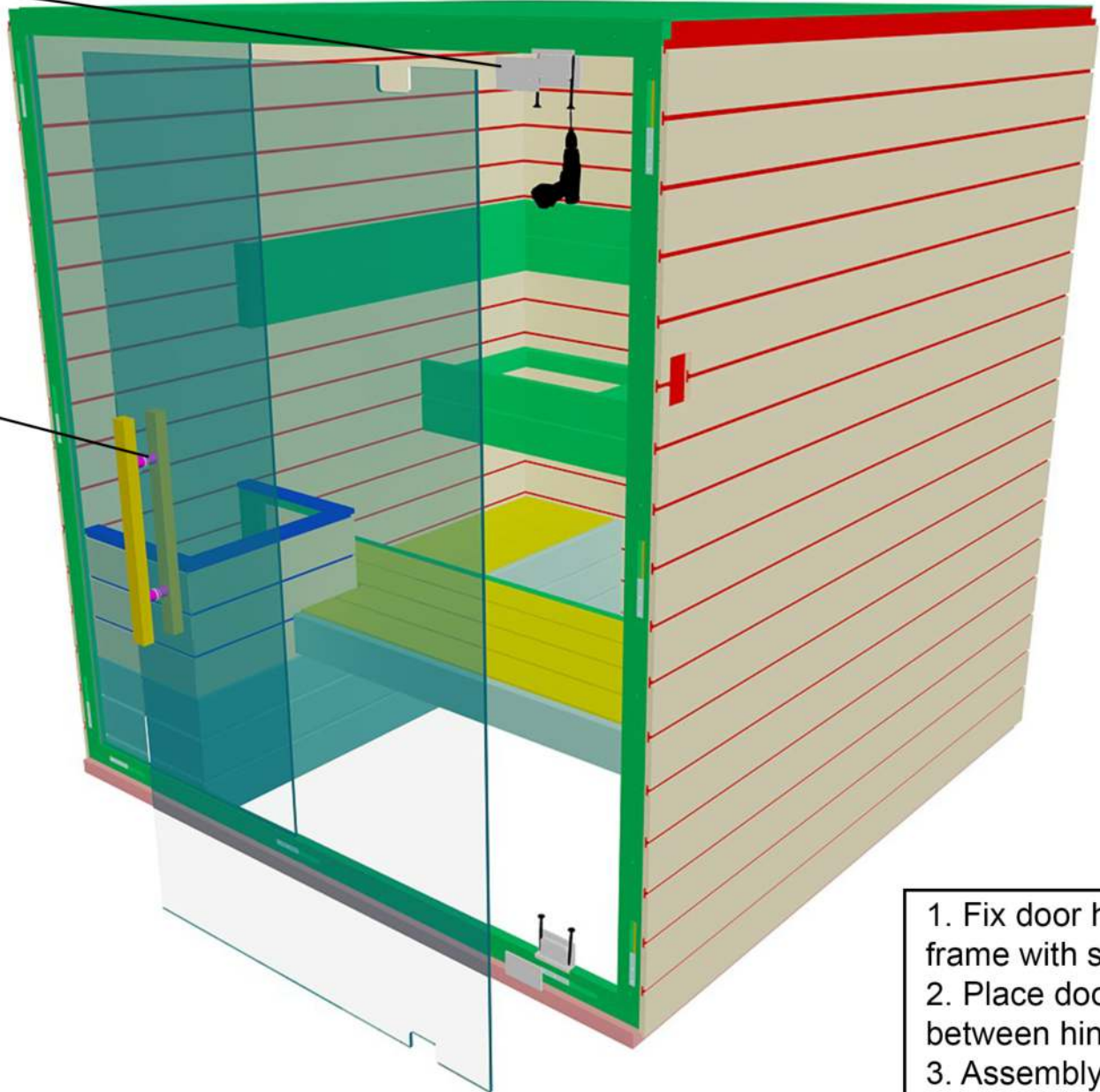
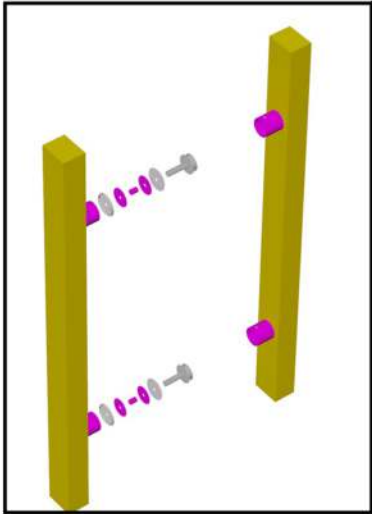
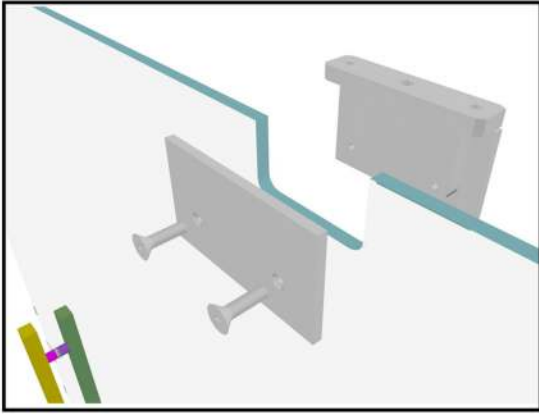

1. Fix door hinges to frame with screws
2. Place door glass between hinges
3. Assembly handle
3. Read hinge manual for regulation

# 16. Upper frame

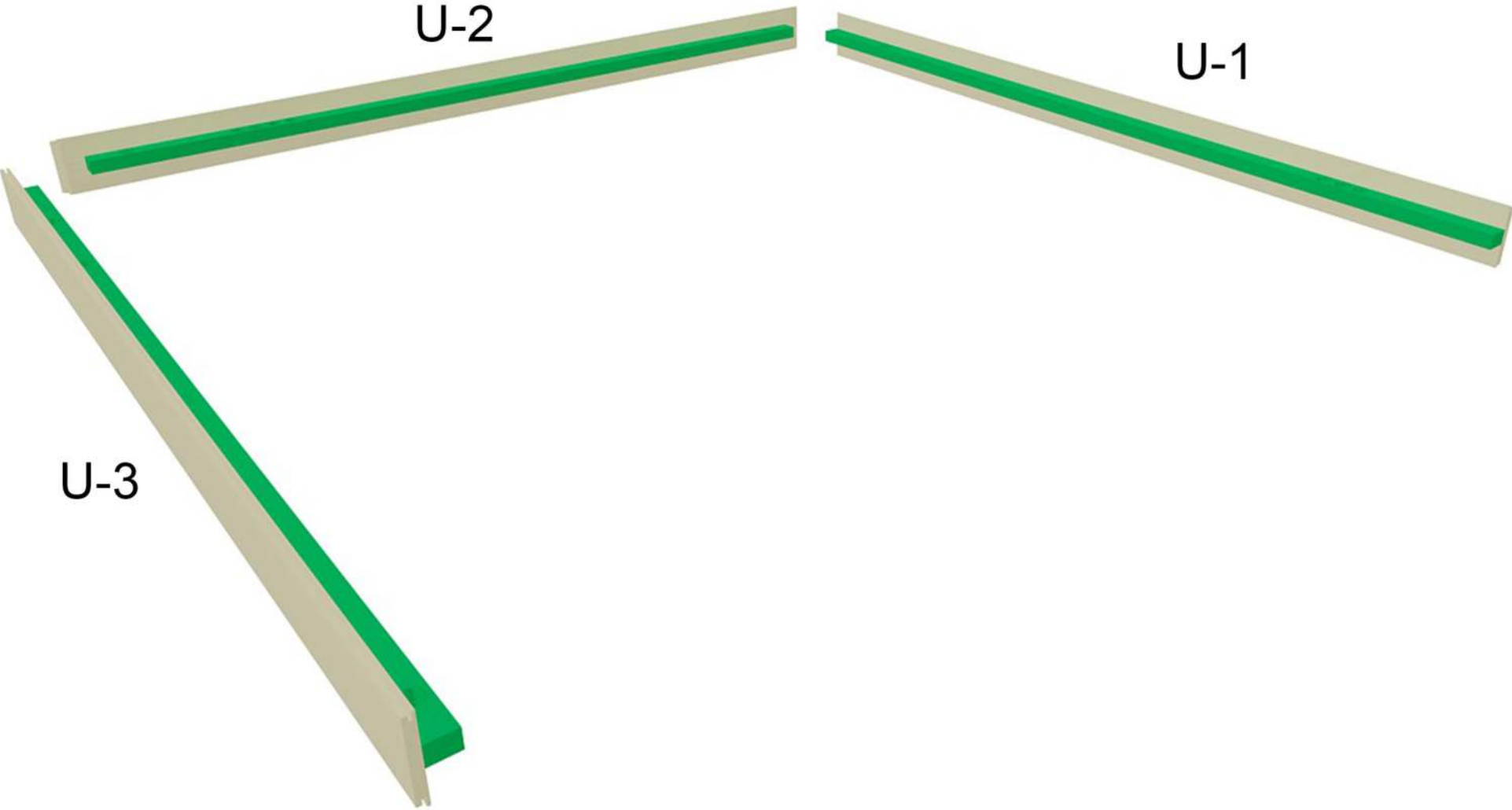

# 17. Fixing upper frame

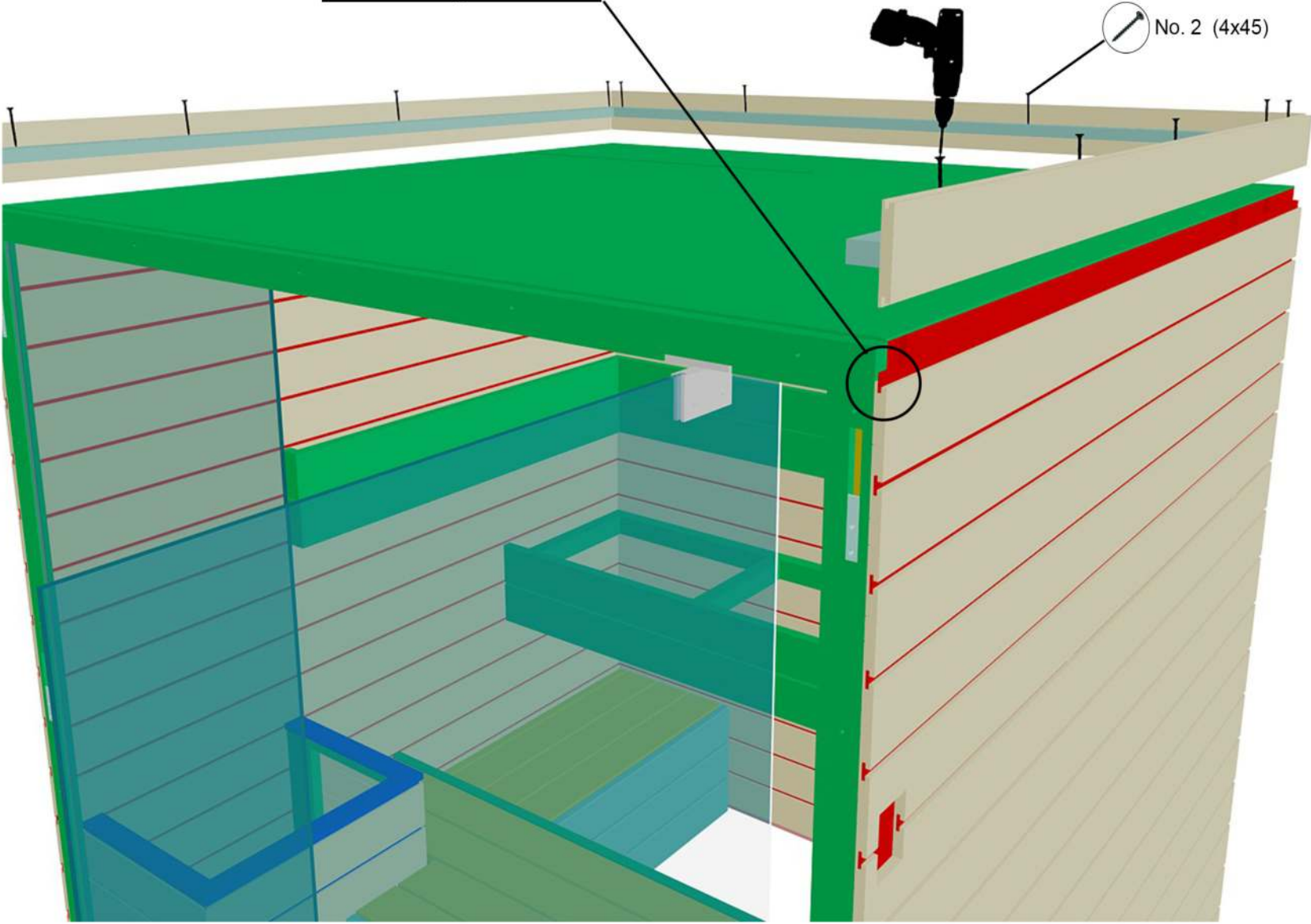
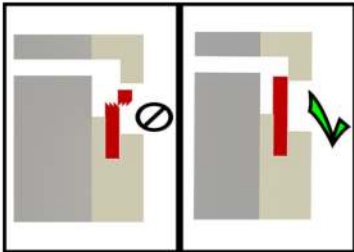

18. Front frame

FF-3

FF-4

FF-2

FF-1

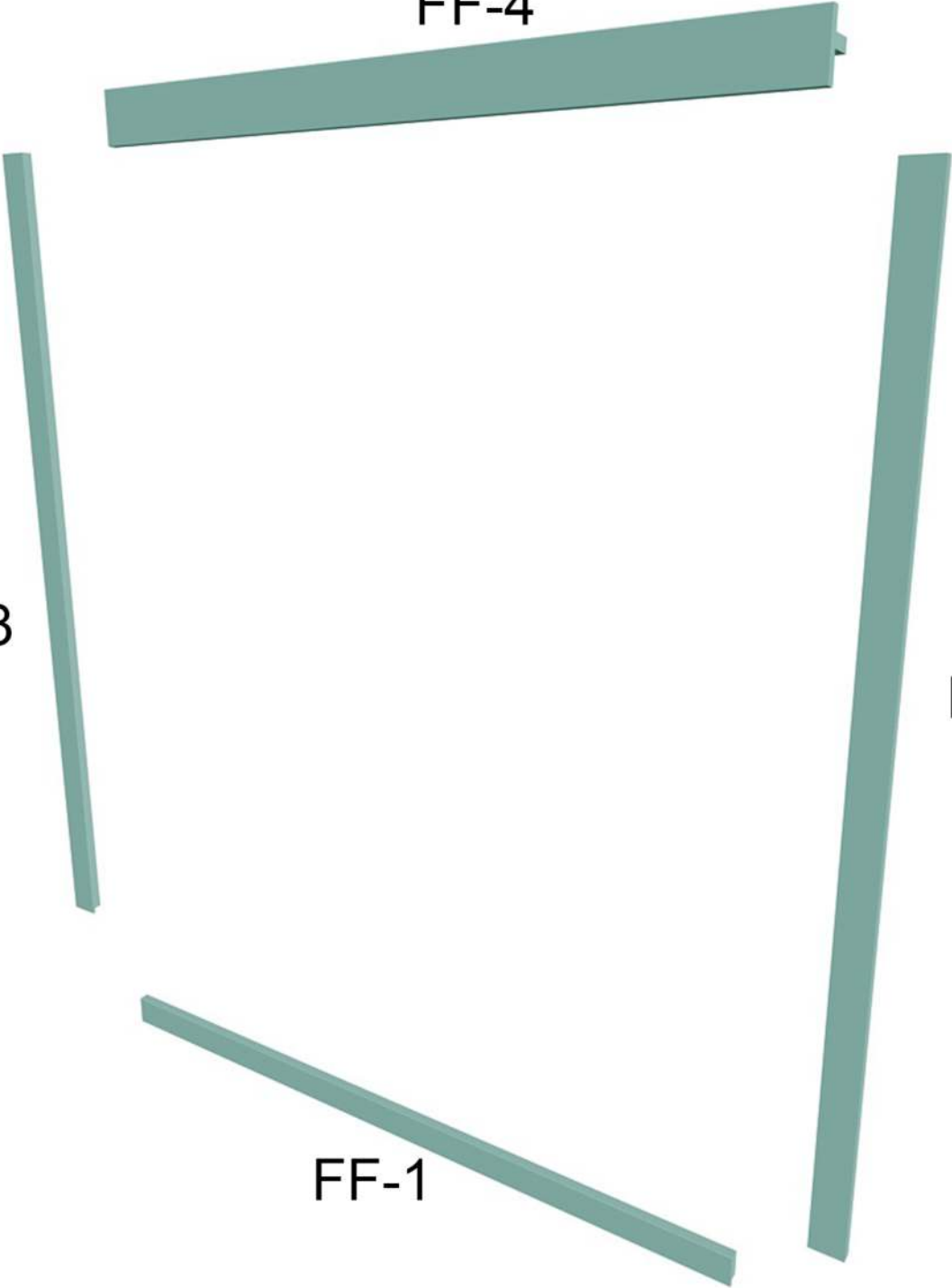

# 19. Fixing front frame

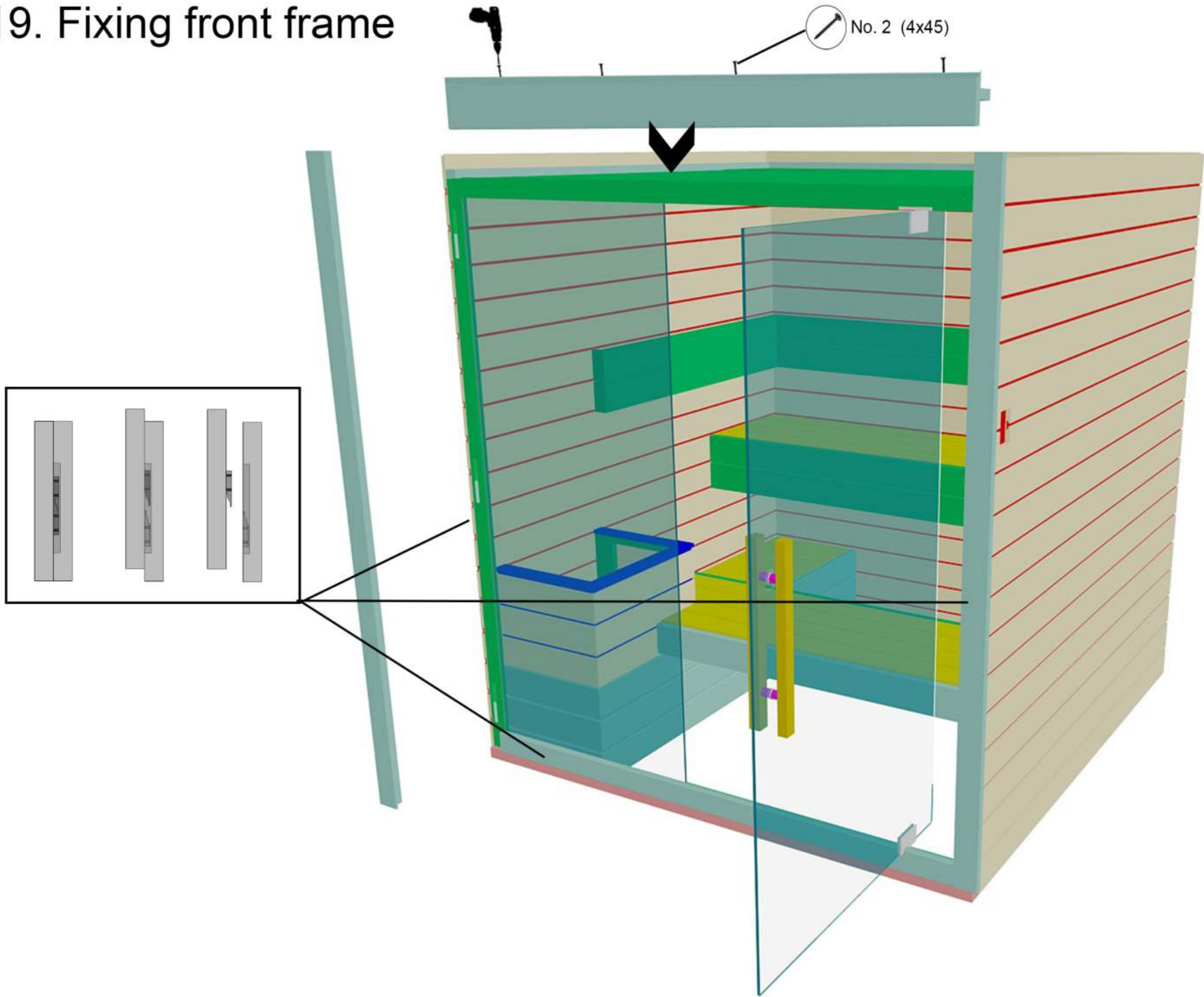

# 20. Floor frames

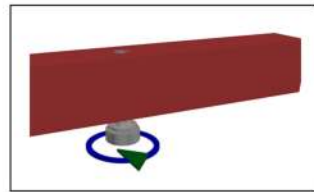
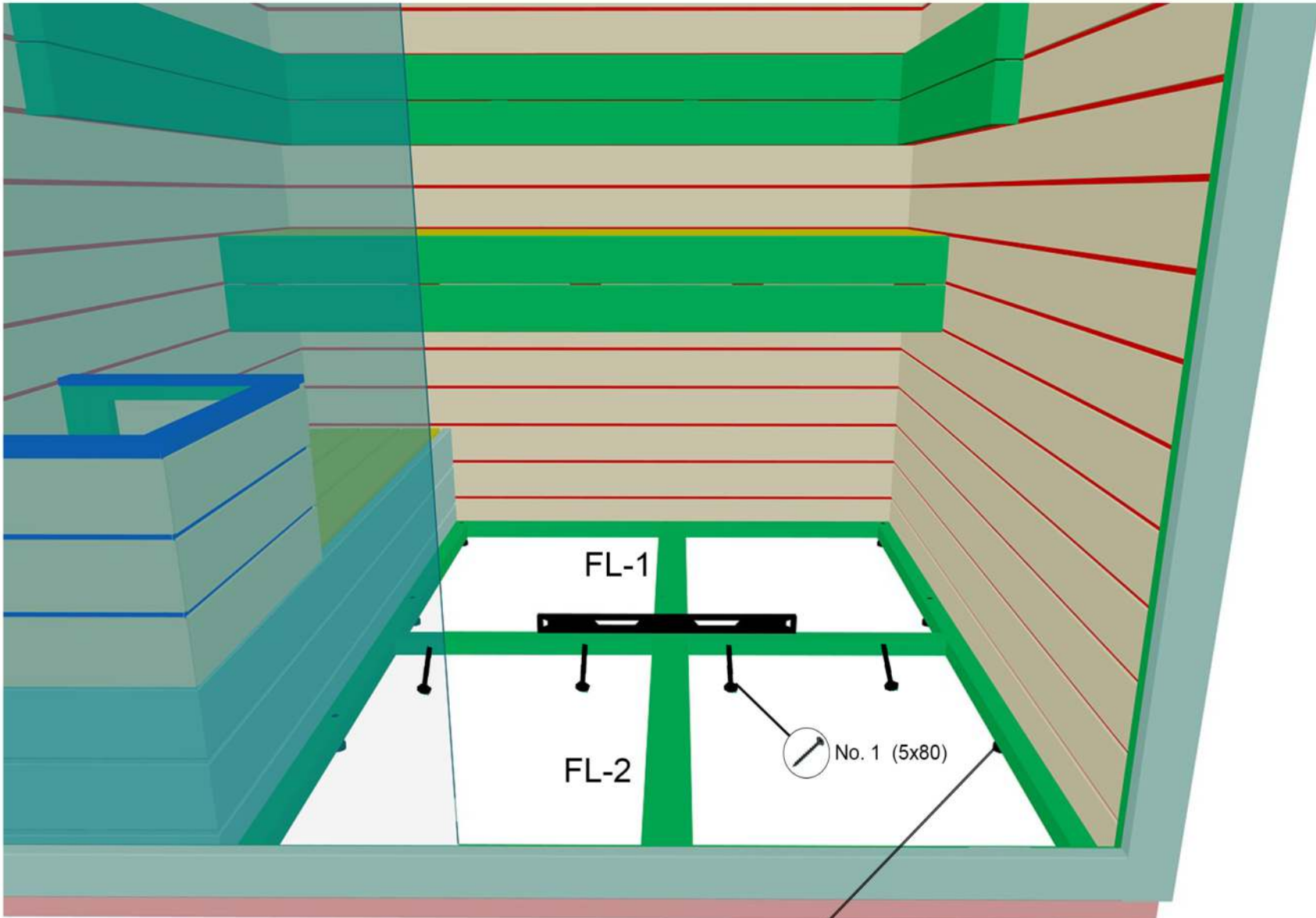



# 20.1 Floor grids

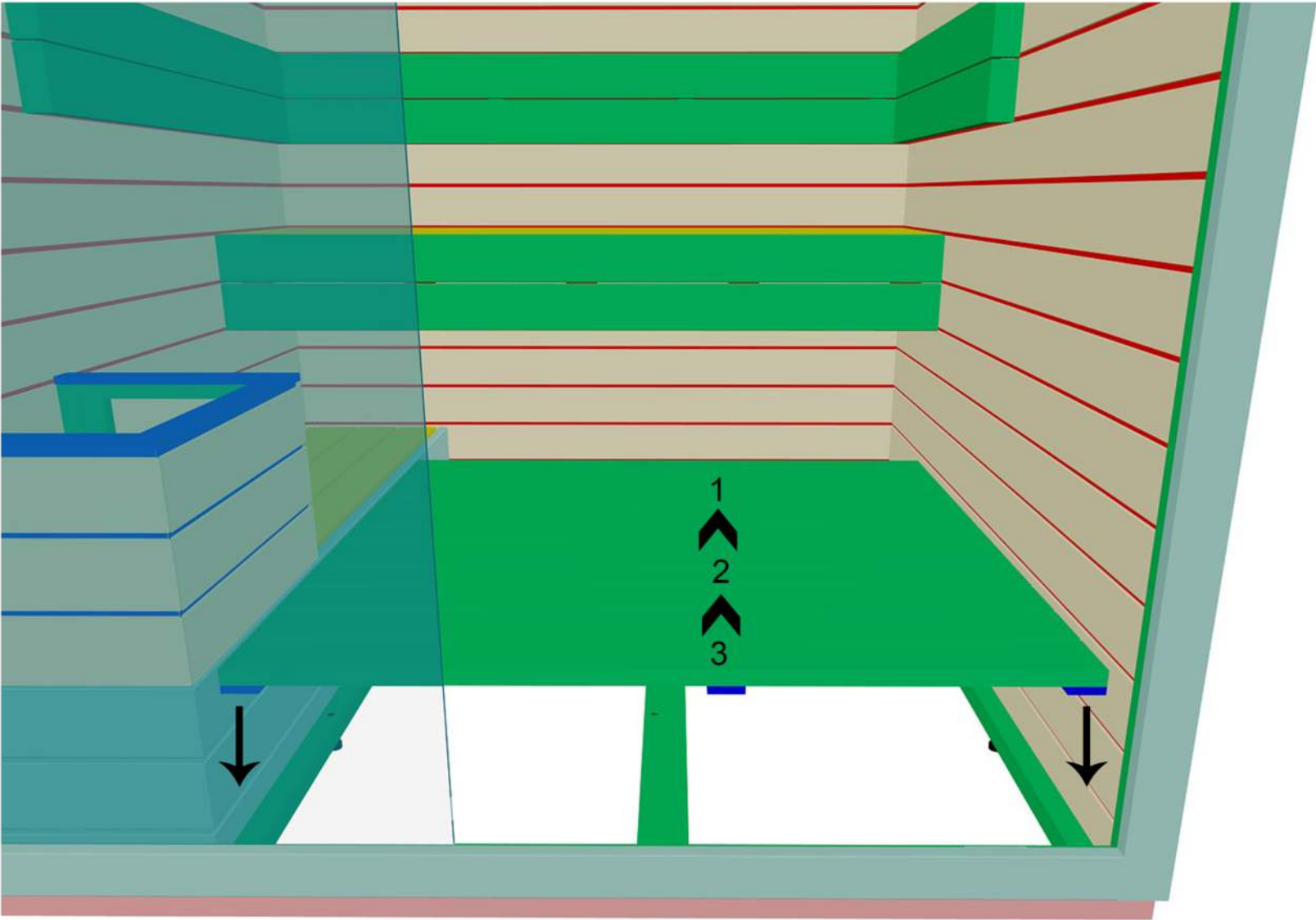

# 21. Wiring on ceilings

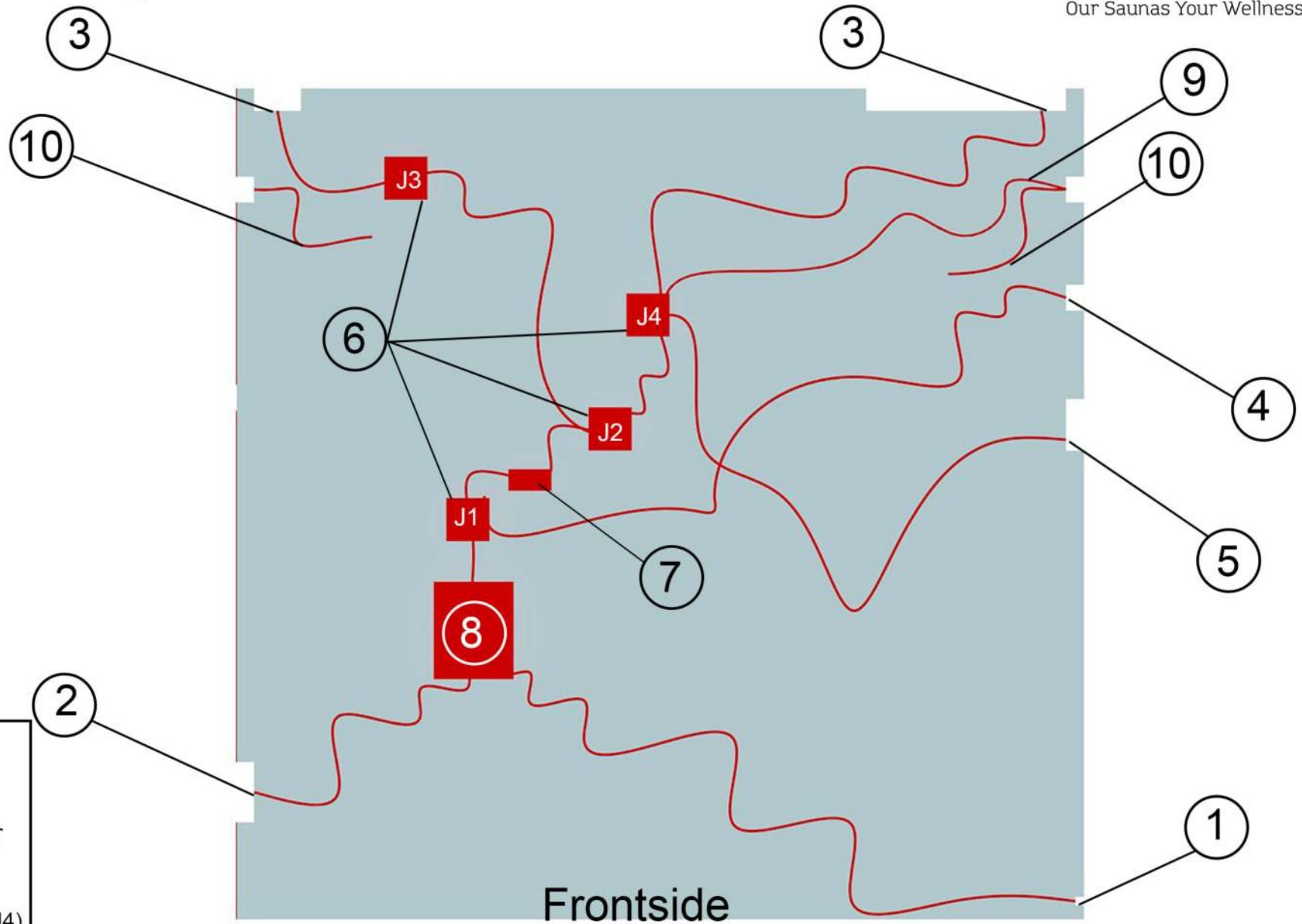

- 1. Control unit cable
- 2. Heater cable
- 3. Backrest LEd-strips
- 4. 230 V for carriti optic fiber (optional)
- 5. Lower bench LED-strip
- 6. Junction boxes (J1,J2,J3,J4)
- 7. Transformer
- 8. Power unit
- 9. Lamp cable (optional)
- 10. Speakers (optional)

Always use certified electrician !