

# TCL

7.1.4 Channel Soundbar with Play-Fi / Dolby Atmos / DTS:X

## X937U

# User Manual



# Contents

---

<b>1 Before you begin .....</b>	<b>3</b>
<hr/>	
<b>2 Welcome.....</b>	<b>6</b>
What's in the box .....	6
Overview of the soundbar .....	8
Overview of the wireless subwoofer .....	10
Overview of the satellite speakers .....	11
Set up your soundbar system.....	12
Position Your soundbar and subwoofer.....	12
Mount your soundbar on the wall .....	15
Mount satellite speakers on the wall.....	18
Install/replace the remote control batteries .....	19
Overview of the remote control.....	20
<hr/>	
<b>3 Connect your Soundbar system .....</b>	<b>22</b>
Connect your soundbar to power supply .....	22
Connect your wireless subwoofer /satellite speakers to the soundbar .....	23
Connect with the HDMI cable.....	24
Optional: connect your Blu-ray player .....	26
Connect with the optical cable .....	27
Direction for setting up your soundbar using an optical cable .....	28

Connect the soundbar with your Bluetooth device .....	29
Add in Google home .....	30
Add in AirPlay 2.....	31
Use spotify connect .....	32
Add in amazon alexa.....	34
Online firmware update.....	36
<hr/>	
<b>4 Use your soundbar system.....</b>	<b>37</b>
Use your soundbar with the top panel or remote control....	37
Listen to music from your Bluetooth device .....	39
Use the USB cable or device for music playback .....	40
<hr/>	
<b>5 Specifications .....</b>	<b>41</b>
<hr/>	
<b>6 Notice .....</b>	<b>42</b>
Disposal of your old product and battery.....	42
Trademarks.....	43
<hr/>	
<b>7 FAQ .....</b>	<b>45</b>

# 1 Before you begin

- Carefully read and observe all safety instructions in the safety leaflet.
- This soundbar is intended for indoor use only. In case it accidentally gets in contact with small amounts of water, unplug immediately and use a dry cloth to remove the water.
- Unplug the soundbar if it is not used for long periods of time or during lightning storms.
- Make sure the soundbar is installed on a solid surface or solidly wall-mounted below your TV for the best experience.
- Only use AAA 1,5V non-rechargeable batteries for the remote control.
- In case any of the cables are visibly damaged or pinched, unplug the soundbar and replace the cable.
- Be careful not to sharply bend the HDMI and optical cable as they may affect the performance.
- Protect your hearing by adjusting to a proper volume. Predefined and customizable sound settings are available for your listening comfort.

## Important safety instructions

Make sure you read all the safety information before you use this product.

TCL ELECTRONICS AUSTRALIA PTY LTD bears no responsibility for accidents or damages caused by unauthorized changes, modifications or improper use of the product.

User Manual can be found at [www.tcl.com/au](http://www.tcl.com/au) on the specific product page in the "Download" section.

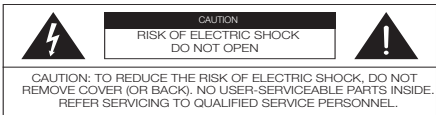

The lightning flash with arrowhead symbol, within an equilateral triangle is intended to alert the user to the presence of uninsulated dangerous voltage within the product's enclosure that may be of sufficient magnitude to constitute a risk of electric shock.



The exclamation point within an equilateral triangle is intended to alert the user to the presence of important operating and maintenance (servicing) instructions in the literature accompanying the product.



This symbol indicates that this product incorporates double insulation between hazardous main voltage and user accessible parts. When servicing, use only identical replacement parts.

## Warnings

- To reduce the risk of fire or electric shock, do not expose this product to rain or moisture. This product should not be exposed to dripping or splashing. No objects filled with liquids, such as vases, should be placed on or near the product.
- The product is unstable if it is not properly placed or mounted to the wall. Be sure to follow the wall mounting instructions provided in the user manual to ensure your safety.
- Do not expose batteries to excessive heat such as sunshine, fire, and so forth.
- To avoid the danger of suffocation, keep plastic packaging away from pets, babies, and children. Do not use packaging bags in cribs, beds, carriages, or playpens.

## Safety

- **Read these instructions** - Read all the safety and operating instructions before operating the product.
- **Retain these instructions** - Retain the safety and operating instructions for future reference.
- **Heed all warnings** - Adhere to all warnings on the product and in the operating instructions.
- **Follow all instructions** - Follow all operating and use instructions.
- **Do not use this apparatus near water** - The appliance should not be used near water or moisture – for example, in a wet basement or near a swimming pool and the like.
- **Clean only with a dry cloth.**
- **Do not block any ventilation openings.** Install in accordance with the manufacturer's instructions.
- **Do not install near any heat sources** such as radiators, heat registers, stoves, or other apparatus (including amplifiers) that produce heat.
- **Do not defeat the safety purpose** of the polarized or grounding-type plug. A polarized plug has two blades with one wider than the other. A grounding type plug has two blades and a third grounding prong. The wide blade or the third prong are provided for your safety. If the provided plug does not fit into your outlet, consult an electrician for replacement of the obsolete outlet.
- **Protect the power cord** from being walked on or pinched particularly at plugs, convenience receptacles, and the point where it exits from the product. If the cord set is damaged, it must be replaced by a special cord set available from the manufacturer or its service agent.
- **Use only attachments/accessories** specified by the manufacturer.
- **Use only with the cart**, stand, tripod, bracket, or table specified by the manufacturer, or sold with the apparatus. When a cart is used, use caution when moving the cart/apparatus combination to avoid injury from tip-over.



- **Unplug this apparatus** during lightning storms or when unused for long periods of time.
- **Refer all servicing** to qualified service personnel. Servicing is required when the apparatus has been damaged in any way, such as power-supply cord or plug damaged, liquid has been spilled or objects have fallen into the apparatus, the apparatus has been exposed to rain or moisture, does not operate normally, or has been dropped.
- **The user must maintain** a minimum distance of 20CM from the device at all time.
- **This appliance is not intended** for use by young children or infirm persons without supervision. Young children should be supervised to ensure that they do not play with the appliance.

## Cautions

- To prevent electric shock, match wide blade of plug to wide slot, fully insert.
- Do not place any sources of danger on the product (for example: liquid filled objects, lighted candles).
- Disconnect the power cord to shut off when find trouble or not in use. The power cord shall be readily operable.
- Use of controls or adjustments or performance of procedures other than those described herein, may result in hazardous radiation exposure or other unsafe operation.
- The power cord/appliance coupler is used as the disconnect device, the disconnect device must remain readily operable.
- The rating label is located at the bottom or back of the product.
- The use of apparatus in tropical and moderate climates.

## Battery precautions

- Do not mix batteries (old and new or carbon and alkaline).
- Do not dispose of batteries in fire or water.
- Recycle or dispose of batteries as per state and local guidelines.
- Danger of explosion if battery is incorrectly replaced. Replace only with the same or equivalent type.
- When the remote control is not to be used for a long time (more than a month), remove the battery from the remote control to prevent it from leaking.
- If the batteries leak, wipe away the leakage inside the battery compartment and replace the batteries with new ones.
- Keep away the batteries from heat or moisture.
- Do not carry or store batteries with other metallic objects. Doing so could cause batteries to short circuit, leak or explode.
- Never recharge a battery unless it is confirmed to be a rechargeable type.
- If the battery compartment does not close securely, stop using the product and keep it away from children.

## Disposal of your old product and battery

Your product is designed and manufactured with high quality materials and components, which can be recycled and reused.

This product may contain lead and mercury. Disposal of these materials may be regulated due to environmental considerations. For disposal or recycling information, please contact your local authorities.

This product contains batteries:

- Do not incinerate. Batteries may explode if overheated.
- For disposal or recycling information, please contact your local authorities.

**CAUTION:** Risk of explosion if the battery is replaced by an incorrect type.

**CAUTION:** Replacement of a battery with an incorrect type that can defeat a safeguard.

**CAUTION:** Disposal of a battery into fire or a hot oven, or mechanically crushing or cutting of a battery, that can result in an explosion.

**CAUTION:** Leaving a battery in an extremely high temperature surrounding environment that can result in an explosion or the leakage of flammable liquid or gas.

**CAUTION:** A battery subjected to extremely low air pressure that may result in an explosion or the leakage of flammable liquid or gas.

# 2 Welcome

Congratulations on the purchase of your new TCL Soundbar! After it is set up and connected, you can experience a superb sound quality and state-of-the-art design to best fit your home entertainment system. You are recommended to read through this user manual which helps you set up, connect and operate the product easily and properly.

Let's get started.

---

## What's in the box



Soundbar

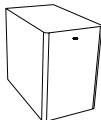

Wireless Subwoofer



Satellite Speaker x 2

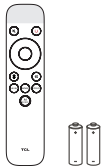

Remote control  
AAA battery x 2



AC power cord x 2



AC power adapter x 2



HDMI cable

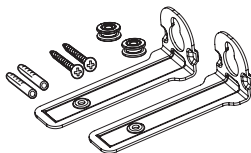

Wall mount kit (for  
Soundbar)



Wall mount kit (for Satellite  
Speaker)



Warranty card

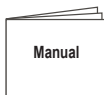

Manual





Wall mount template

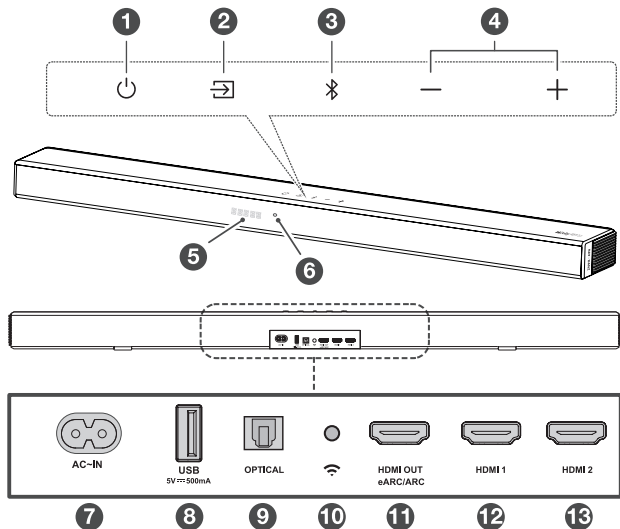

# Overview of the Soundbar



-  Short press to enter Sleep mode.  
Long press to enter Standby mode.
-  Press to switch the audio source among HDMI ARC/HDMI IN/OPT/BT/USB modes.
-  Press to select the Bluetooth function. Press and hold to enter the pairing mode.

4 **+ / -**

Press to increase or decrease the volume level.

5 **LED Display**

It indicates the Soundbar status (e.g. volume level, Soundbar status).

6 **White LED:**

It indicates Wi-Fi connection status.

7 **AC input power connector**

8 **USB Type A connector (only for music playback)**

9 **Optical input connector**

10 **Wi-Fi setup button**

11 **HDMI OUT (eARC/ARC) connector**

12 **HDMI 1 IN connector**

13 **HDMI 2 IN connector**

---

# Overview of the wireless subwoofer

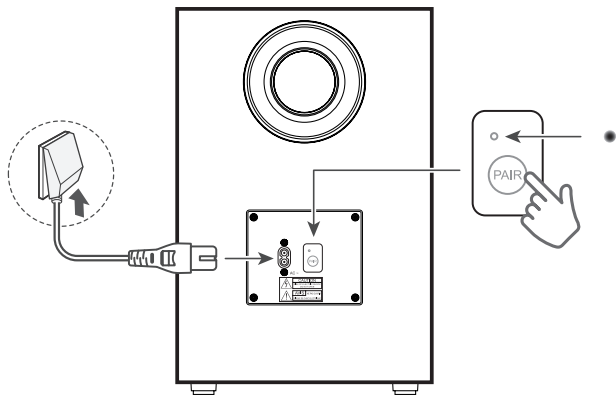

## 1 AC input power connector

## 2 Amber LED indicator

- flashes slowly when the subwoofer is in standby mode.
- flashes quickly when pairing is in progress.
- remains on solidly when pairing is successful.

## 3 PAIR

Press and hold  button on the Soundbar main unit for 5 seconds. Press and hold **PAIR** button on the subwoofer until pairing is complete. And then the amber LED light will be solid on the subwoofer.

## Note

- Manual pairing is needed only in case of troubleshooting.

## Overview of the satellite speakers

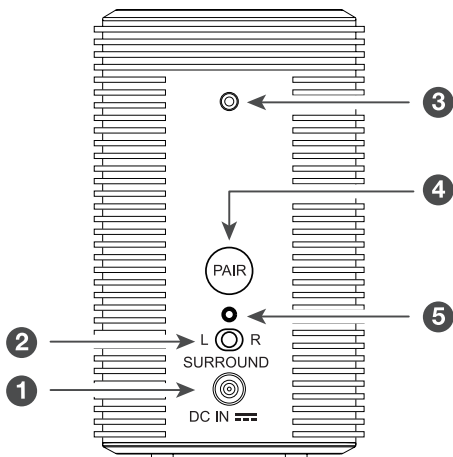

- 1 **DC input power connector**
- 2 **Toggle switch: Set sound to Left or Right Surround Speaker**
- 3 **Screw hole: Install the wall-mounting screws here.**
- 4 **Pairing button: Activate the pairing between the satellite speaker and the main sound bar unit.**
- 5 **Pairing Display**
  - Slowly flashing: Not paired / to be paired
  - Fast flashing: In pairing
  - Constant on: Connected / Paired

---

# Set up your Soundbar system

## Notes

- Make sure you read all the safety information before you mount the Soundbar main unit on the wall.
- Make sure you use screws provided or specified by the authorized manufacturer.
- TCL AUSTRALIA bears no responsibility for accidents or damage caused by improper wall mounting and screws installation or insufficient wall strength, etc.
- Additional tools (not supplied) are required for installation.
- You can choose to place your Soundbar below the center of your TV or mount it on the wall.

---

## Position Your Soundbar and Subwoofer/Satellite Speaker

The ideal place to position the Soundbar main unit is centered underneath your TV.

You are recommended to place the Soundbar main unit on the top of the cabinet and right below the center of your TV.

The distance between the subwoofer/satellite speaker and the Soundbar main unit should be less than 3 meters.

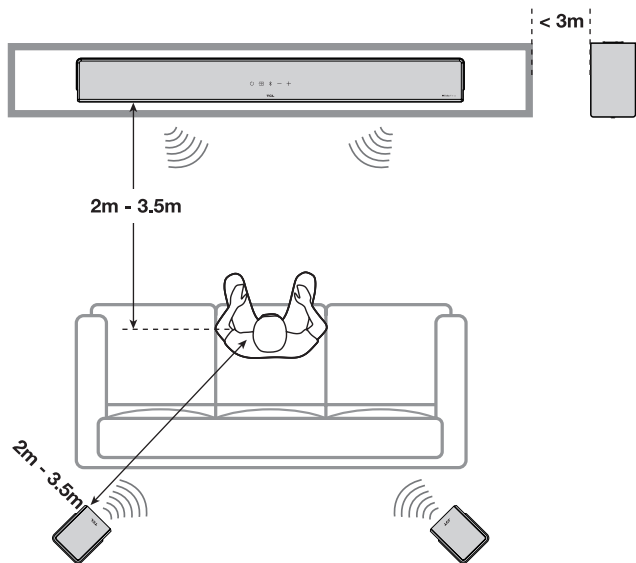

## AI Sonic-Adaptation

AI Sonic-Adaptation is a Room Calibration Technology developed by TCL Audio Lab. To use this function, you need to download TCL Home App and follow the instructions.

This Sound Bar can be fully controlled by TCL-HOME App. Features are not limited including power, volume, input, effect, level, mode, AI Sonic-Adaptation etc. As well, TCL Home App can help you to explore more smart features without just a sound bar. Please download from App stores.



Available on the  
**App Store**



GET IT ON  
**Google Play**

### Before AI Sonic-Adaptation

Speaker distance, sound pressure level, and frequency response are **all uneven**. Based on your sitting area and room field.

### After AI Sonic-Adaptation

Speaker distance, sound pressure level, and frequency response are **all equalized**. Based on your sitting area and room field.

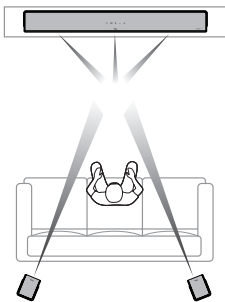

The sound field will be measured by cellphone and microphone.

#### Calibration

TCL Home App will analyze the data received from the cellphone microphone and send adjustment data to the Sound Bar.

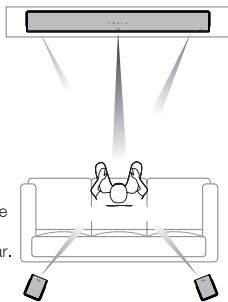

## Mount your Soundbar on the wall

- 1 Place the supplied wall mount template on the wall. Make sure the wall mount template is at least 5cm below the center of the TV.
- 2 Use a level to make sure the wall mount template is positioned accurately.
- 3 Use tape to stick the wall mount template firmly on the wall.
- 4 Mark on the wall using each marking on the template through the mounting holes.
- 5 Take away the wall mount template.
- 6 Drill a screw hole at each marking on the wall.

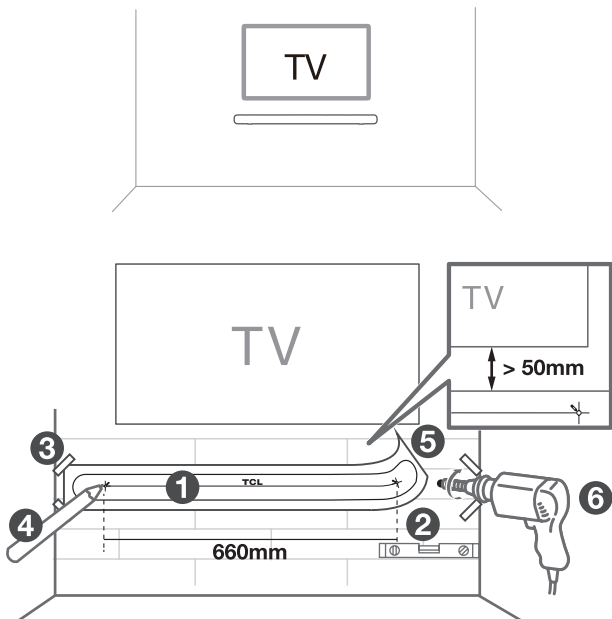



- 7 Insert the supplied screws into the hole of the wall anchors.
- 8 Insert the sleeves into the hole of the wall anchors.
- 9 Fix and tighten the wall bracket screws on the wall.  
(Reserve the rubber cushions for future use)  
\* The rubber cushions can be used as soundbar mats when you put the soundbar on the table.  
Screw on the wall mount brackets to the soundbar.
- 11 Hang the Soundbar on the screws.
- 12 Ensure the soundbar is stable and safe hanging on the wall.

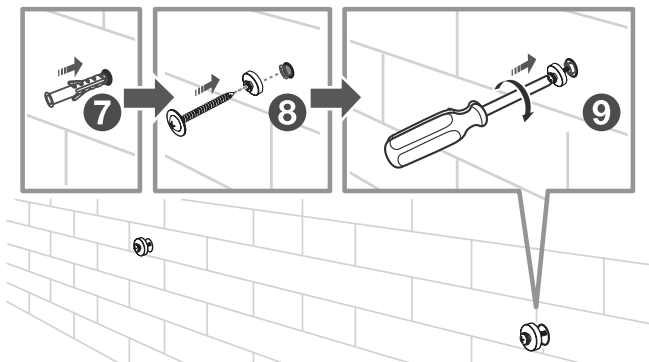

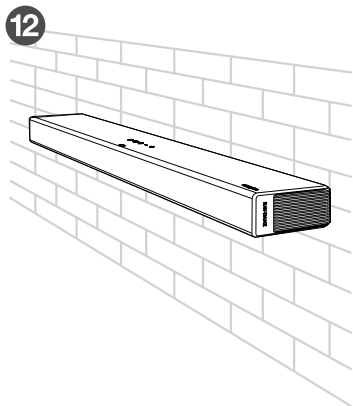
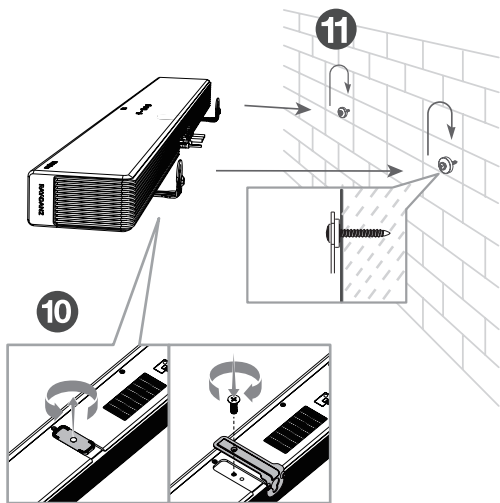

## Notes

- Check the installation location before you mount the Soundbar on the wall (see 'Mount your Soundbar on the wall' on page 15).
- You may consider to connect the cables first before mounting the Soundbar on the wall.

---

## Mount satellite speakers on the wall

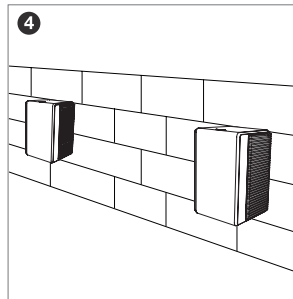
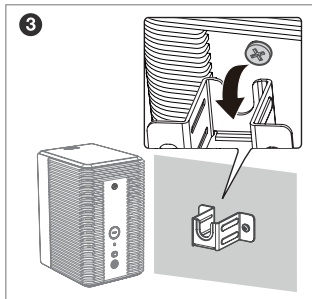
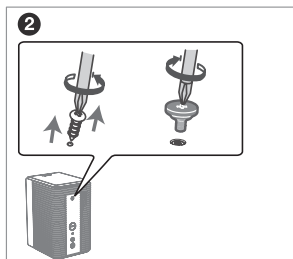
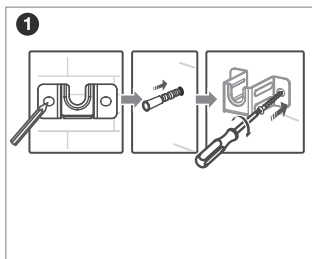

---

# Install/replace the remote control batteries

## Warnings

- *Danger of explosion if battery is incorrectly replaced. Replace only with the same or equivalent type.*

## Caution

- 1 Open the battery compartment, remove the old batteries if necessary.
- 2 Place two new AAA batteries into the battery compartment with the correct polarity (+/-).
- 3 Close the battery compartment.

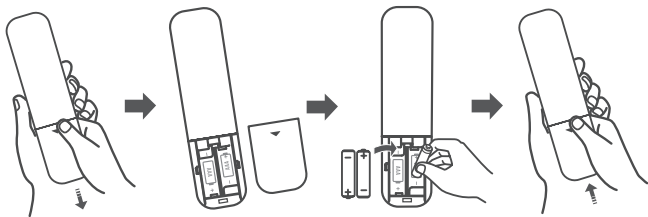

Setup is complete. Your Soundbar is ready to use. For more information about how to access different connection options on your Soundbar, see the following chapter.

# Overview of the Remote Control

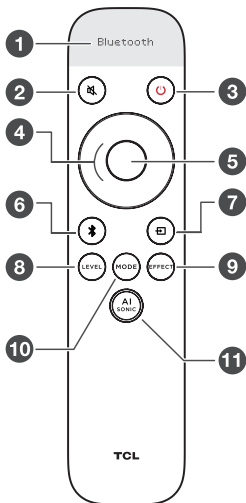

- 1 Screen display.
- 2 Short press: mute / unmute the sound.
- 3 Short press: power on / sleep  
Long press: standby.
- 4 Up/Down: increase/decrease the volume  
Left/Right: Switch to previous/next music (Under Bluetooth or USB mode).
- 5 Short press: Play / Pause.
- 6 Long press: Bluetooth Pairing  
Short Press: switch to Bluetooth mode.
- 7 Short press to enter input source menu.  
Keep short press or use Up/Down/Left/Right to switch:  
HDMI-eARC/Optical/USB/Bluetooth/HDMI 1/HDMI 2.

- ⑧ Short press to enter the Level Menu. Switch different Level Options<sup>[1]</sup> with Left/Right.  
Use Up/Down to adjust the value.
- ⑨ Short press to enter Effect Menu.  
Use Left/Right to switch different Effect Options<sup>[2]</sup>  
Use Up/Down to adjust Effect ON/OFF or 1/2/3 Effect.
- ⑩ Short Press to enter sound modes menu.  
Keep short press or use Up/Down/Left/Right to switch sound modes: Standard, Voice, Music, Movie, Game, Sports.
- ⑪ Short Press to enter AI Sonic-Adaptation<sup>[3]</sup> Menu.  
Short press “Up/Down” to switch different AI Sonic Adaptation: Default / Sonic 1 / Sonic 2 / Sonic 3.

[1] Level Options: Bass, Treble, Dialogue, SurrVol, Av Sync.

[2] Effect Options: Bass Boost, Surround Enhance, Pass through, Night, NEURALX, DRC, LED Dim.

[3] AI-Sonic Adaptation: Learn more on page 13.

**Note:**

Factory Mode: Long Press Mode+Mute together for 5 seconds.

# 3 Connect your Soundbar system

After you have fixed the position of the Soundbar, you can start connecting it to your TV or other devices and listen to the audio through your Soundbar. Make sure you have muted the audio of your TV or device. For information, check the user manual of your TV or device.

---

## Connect your soundbar to power supply

- 1 Make sure that you have completed all other connections before connecting the Soundbar to power supply.
- 2 Make sure the power supply voltage complies with your country's safety standards (see 'Specifications' on page 41)
- 3 Connect one end of a supplied AC power cord to the AC input connector on your Soundbar and another end to the power socket on the wall.

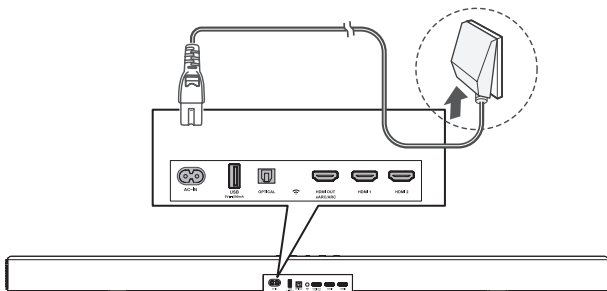

---

## Connect your wireless subwoofer / satellite speakers to the soundbar

When the wireless subwoofer / satellite speakers are connected, you can enjoy powerful deep bass sounds and a truly immersive audio experience.

THE SUBWOOFER AND SATELLITE SPEAKERS HAVE BEEN PAIRED WITH THE SOUNDBAR MAIN UNIT UPON FIRST USE. In case of a problem, take the following steps to manually pair:

Make sure both the Soundbar and wireless subwoofer / satellite speakers are connected to the power supply and are turned on.

- ➔ Long press **PAIR** button on the subwoofer / satellite speakers for 3 seconds until indicator light flashing fast.
- ➔ Long press **⏏** on the soundbar for 5 seconds till "SETUP PAIR" displaying on the soundbar.
- ➔ When indicator light turns solid on the subwoofer or the satellite speakers, pairing is successful.

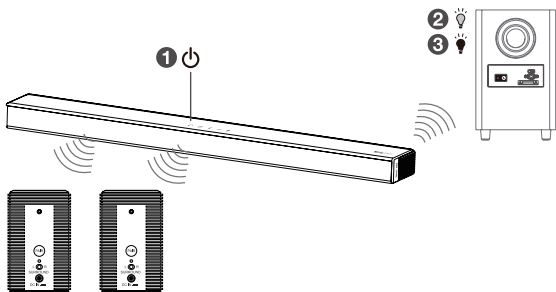



# Connect with the HDMI cable

## Note

- Make sure your TV or device supports the HDMI ARC feature. For information, check the user manual of your TV or device.

Connect one end of the HDMI cable to the HDMI ARC input connector on your Soundbar and another end to the HDMI ARC output connector of your TV or device.

To get the best possible audio experience using the HDMI cable, follow below given steps:

For TCL TV:

- 1 Connect HDMI cable from the HDMI (ARC) interface on the Soundbar to the HDMI (ARC/eARC) interface on the TV. Connect power cord.
- 2 Enable the CEC function in the settings of the TCL TV.

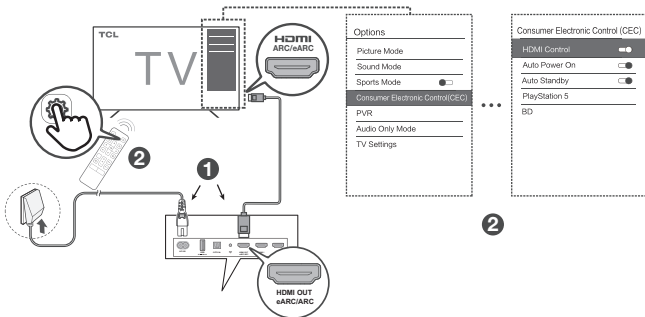

For other TV brands:

- 1 Connect HDMI cable from the HDMI (ARC) interface on the Soundbar to the HDMI (ARC/eARC) interface on the TV. Connect power cord.
- 2 Enable the CEC function in the settings of the TV.

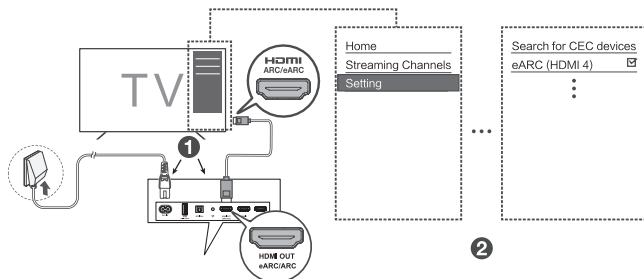

★ CEC (Consumer Electronic Control) function naming may differ by TV manufacturer. This feature may be called CEC, Anynet+, SimpLink, BRAVIA Link, EasyLink or VIERA Link. Please see your TV's user manual for more information.

---

## Optional: Connect your Blu-ray player

For ease of use, you are advised to connect a Blu-ray player to the TV and enjoy the Soundbar through HDMI-ARC. However, in order to enjoy **Dolby TrueHD** based **Atmos** content that not all TVs may support through HDMI-ARC, you can optionally connect your Blu-ray player directly to the Soundbar using the HDMI-in port.

### Notes

- The Soundbar will pass on the video signal to the TV. If it is not successful, turn on the Soundbar and try again.
  - The HDMI input supports UHD (4K) and that it can also be used for game console to enjoy Dolby Atmos audio.
- 
- 

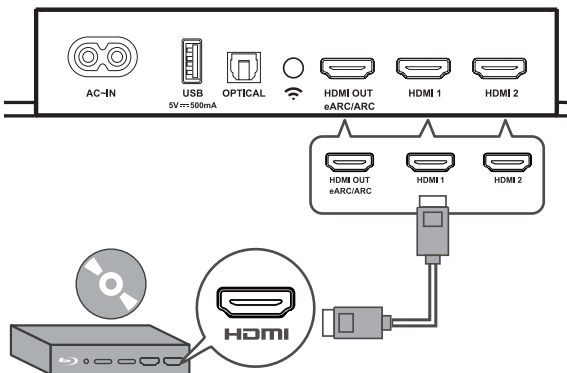

---

## Connect with the optical cable

- 1 Remove the protective caps from the optical cable when necessary.
- 2 Connect one end of the optical cable to the optical input connector on your Soundbar and another end to the optical output connector of your TV or device.

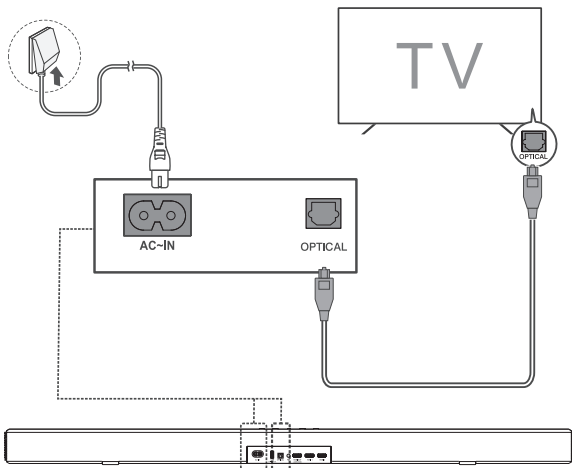

### Note

- If there is no sound output from the Soundbar, try to activate the PCM signal output on your TV or device. PCM is used to convert analog audio signals into digital audio signals in most devices. For more information of how to activate the PCM signal output, check the user manual of your TV or device.

---

## Direction for setting up your Soundbar using an optical cable



Do not bend or kink the optical cable (SPDIF) as it is fragile and can easily get damaged and broken.

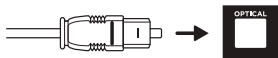

To get the best possible audio experience using the optical cable:

- 1 Press the Home button on your TCL TV Remote.
- 2 Navigate to **Audio option** under **Settings**.
- 3 Uncheck the “**TV speaker enabled**” option.
- 4 Under **S/PDIF** and **ARC**, select **Auto**.



### Notes

- *Different devices may have different menu options.*
- *Devices such as Blu-ray players, set-top boxes, etc., are also applicable.*

---

# Connect the Soundbar with your Bluetooth device

## Notes

- Make sure your wireless device supports the Bluetooth function.
  - The operational range between the Soundbar and your Bluetooth device is approximately 10 meters (without any obstacle between the Bluetooth device and the Soundbar).
- 1 Press  on the top panel of your Soundbar or remote control to power on the Soundbar.
  - 2 Press and hold  on the top panel of your Soundbar or remote control.  
→ PAIR is displayed on the LED display. The Soundbar is ready to pair.
  - 3 Power on your Bluetooth device and activate its Bluetooth function.
  - 4 Select **TCL X937U Sound Bar** on the pairing list of your Bluetooth device.  
→ You hear distinct double beep sound.  
→ You'll see "Connected" on the screen.

## Tip

- If you cannot find the model name **TCL X937U Sound Bar** on your Bluetooth device, press and hold  on the remote control. You will see PAIR . Now the Soundbar is coming into the pairing mode.

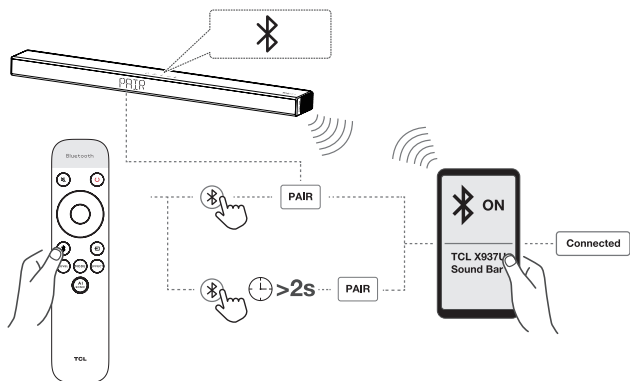

Your Soundbar system is now set up and ready to be used.

- 5** To disconnect the Bluetooth function, you can:
- press  on the Soundbar or remote control to switch to another source; or
  - disable the Bluetooth function on your device.

---

## Add in Google home

1. Power on the Soundbar.
2. On an Android phone, open the Google Home app and continue with step 3.
3. In the Google Home app, make sure you are signed in and follow the on-screen instructions to complete the setup process.
4. Once setup is complete via step 3, you are now connected to your network and Wi-Fi. Now you can enjoy Chromecast built-in from any device on the same network.

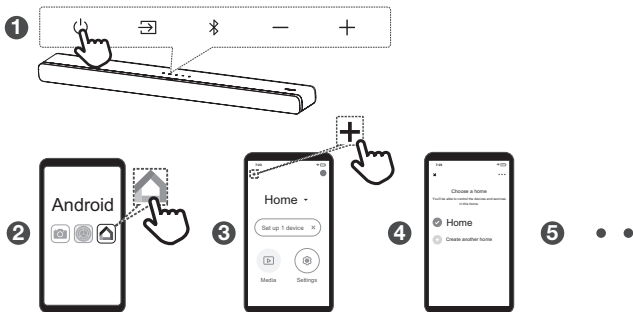

---

## Add in AirPlay 2

1. Power on the Soundbar.
2. On an iOS device, go to Settings > Wi-Fi and continue with step 3.
3. For the Airplay 2, in Settings > Wi-Fi, look for "TCL X937U Soundbar" under "SETUP AS NEW AIRPLAY SPEAKER" and complete the setup process.
4. Once setup is complete via step 3, you are now connected to your network and Wi-Fi. Now you can enjoy AirPlay from any device on the same network.



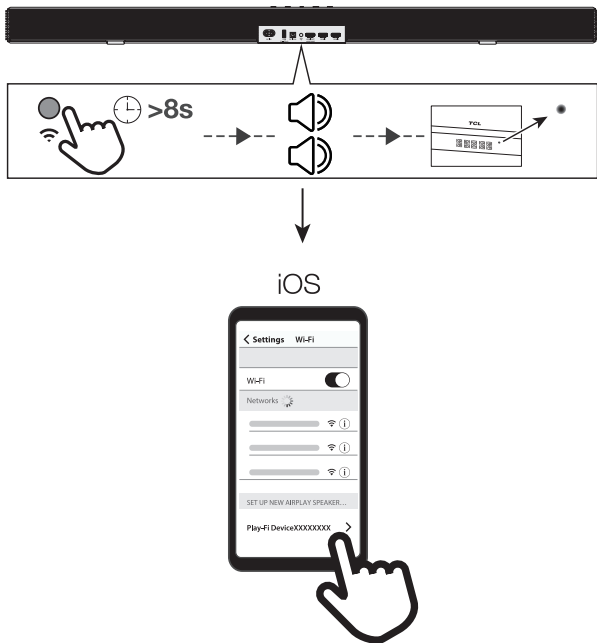

---

## Use Spotify Connect

Use your phone, tablet or computer as a remote control for Spotify. Go to  Explore - Spotify to learn how:

1. Scan the QR code or search in App store to download Spotify App.
2. Press the button on the back of the soundbar for more than 8 seconds. You will hear two beeps and see the LED from flashing to lighting up solidly.

3. Select the Play-Fi device on your phone.
4. Open the Play-Fi App, connect Wi-Fi network.
5. Set up Wi-Fi device with a Wi-Fi network.
6. Download and update the Play-Fi App. And then you can enjoy the functions of the new version App.

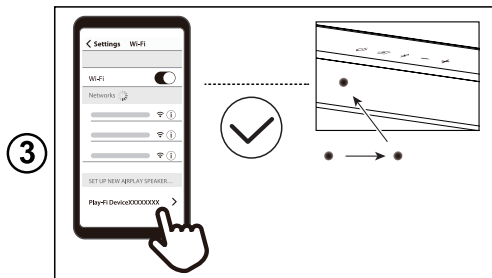
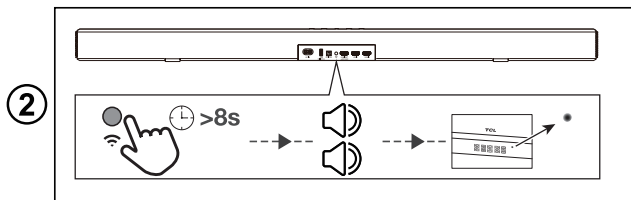
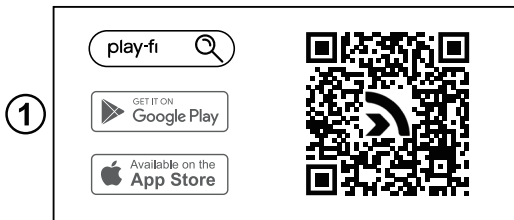

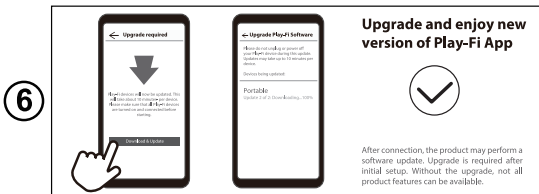
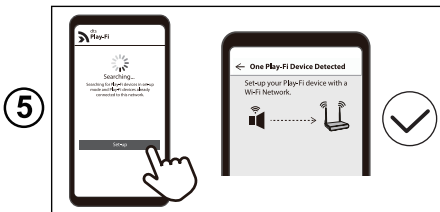
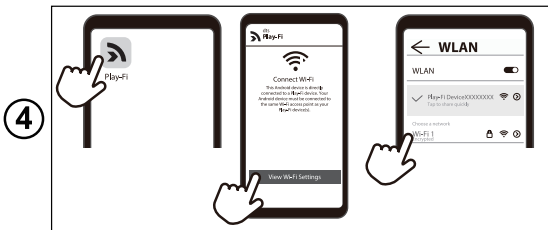

## Add in Amazon Alexa

1. Fix the Play-Fi App and Wi-Fi Network and go through all the update procedures.
2. The app should automatically prompt you to link it to your Amazon account. Or by going into Settings in the Play-Fi app, and selecting the Amazon Alexa option.
3. Depending on your location, you may be prompted to select your default language for Alexa. Once ready to proceed, Alexa

will prompt you for your Amazon account, but if you've already used an Amazon sign-on or authentication on your device before, it should automatically apply the credentials for you.

4. If you're linking your Amazon account to a Play-Fi products without microphones, you'll have to ask an Echo, Dot, or similar product to "Discover Devices" so that your new product can be identified.

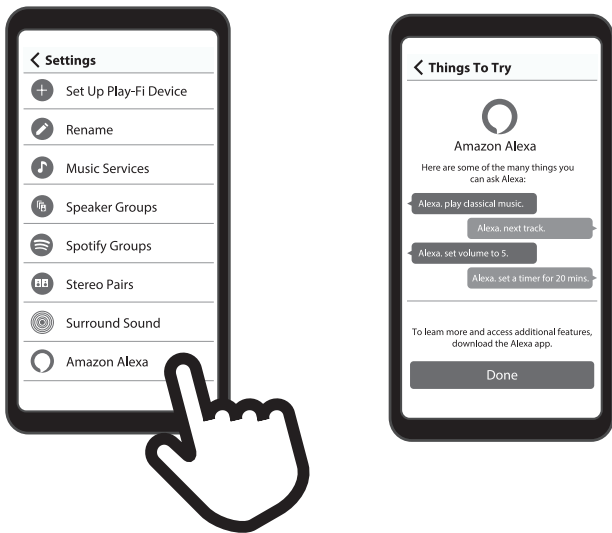

# Online Firmware Update

Automatic detection and upgrade of Soundbar software:

1. Ensure your Soundbar, subwoofer and satellite speakers are powered up.
2. Ensure your Soundbar, subwoofer and satellite speakers pair successfully.
3. Ensure your Soundbar is connected to Wi-Fi network successfully (Refer to Wi-Fi connection steps on page 30/31/32/34.)
4. You will see the following LED indications:  
DOWNLOADING >> CHECK > UPGRADE > UPG00~99  
> U OK > START

Note: Do not interrupt the Soundbar and subwoofer during the upgrading.

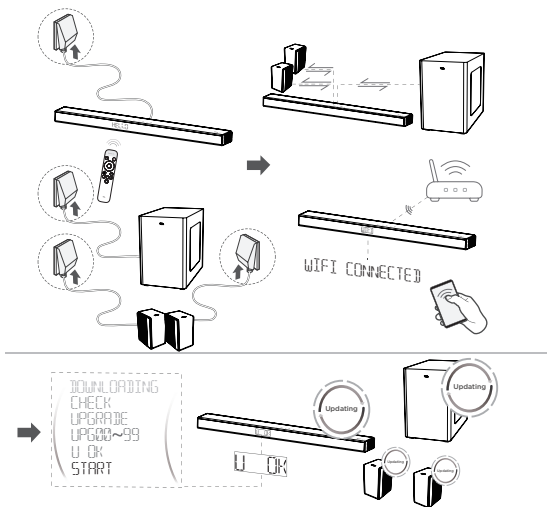

# 4 Use your Soundbar system

---

## Use your Soundbar with the top panel or remote control

- 1 Make sure the Soundbar is properly connected to the power supply and sources.
- 2 Press  at the top panel of your Soundbar main unit or remote control to switch to the correct source.

The LED display on the Soundbar gives you information about the status of the Soundbar.

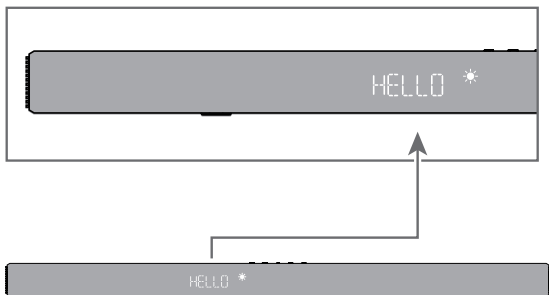

HELLO \*

	Soundbar Status	LED Display Status
<b>Power</b>	Power on Power off	HELLO STBY / SLEEP
<b>Source</b>	HDMI eARC/ARC Optical USB Bluetooth HDMI 1 HDMI 2	ARC / EARC OPT USB BT HDMI1 HDMI2
<b>Bluetooth</b>	Searching mode (flashing) Pairing mode	BT PAIR
<b>Volume control</b>	Volume level Minimum volume reached Maximum volume reached Mute	V 36 MIN MAX MUTE
<b>LEVEL</b>	BASS (+/-) TREBLE (+/-) SurrVol (+/-) Dialogue Av Sync	BAS-S / BAS+S TRE-S / TRE+S SR-S / SR+S DIAL0 / DIAL6 SYNC
<b>Sound modes</b>	Standard/Voice/Music/Movie/ Game/Sports	STANDARD VOICE MUSIC MOVIE GAME SPORT
<b>Sound EFFECT</b>	BassBoost SurrEnhan Pass Thru Night NEURALX DRC  LED DIM	BASBST ON / BASBST OFF SURRENH ON / SURRENH OFF PASSTH ON / PASSTH OFF NIGHT ON / NIGHT OFF DTSNEU ON / DTSNEU OFF DTSORC LOW / DTSORC MID / DTSORC HIGH DIM 1 / DIM 2 / DIM 3

**Note:** After powering on your Soundbar, if there is no operation performed on either the Soundbar or remote control within 10 seconds, all LED indicators on the Soundbar will turn off and light up again when the operation is resumed.

**Tip:** You can use more advanced functions on the remote control (see ‘Overview of the remote control’ on page 20).

---

## Listen to music from your Bluetooth device

- 1 Make sure that your device supports A2DP and/or AVRCP. For information, check the specification of your device.
- 2 Pair your Bluetooth device with the Soundbar (see ‘Connect the Soundbar with your Bluetooth device’ on page 29).
- 3 Start listening to music stored in your Bluetooth device through the Soundbar.
  - If your Bluetooth device supports A2DP, you can listen to music, but you cannot control the playback.
  - If your Bluetooth device supports AVRCP, you can listen to music and control music playback with the remote control. Press the center button to pause or resume music playback. Press left/right to skip to the previous/next track.

### Note

- The operational range between the Soundbar and your Bluetooth device is approximately 10 meters (without any obstacle between the Bluetooth device and Soundbar).



---

## Use the USB cable or device for music playback

- Press **▶/OK** on the remote control to listen to/pause/resume the music.
- Press left/right button on the remote control to skip to the previous or next track.
- Press up/down button to increase or decrease the volume level.

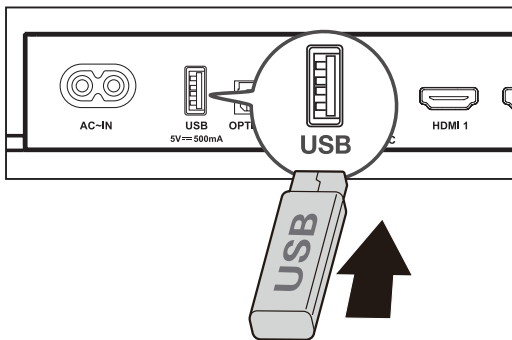

### Tip

- This Soundbar can support USB devices of up to 64GB memory and the supported file format is MP3.
- Music in folders of the USB device should be within 5 (including 5) directory levels. Otherwise, the Soundbar can not detect the music.

# 5 Specifications

## Product Name

7.1.4 Channel Soundbar with Play-Fi / Dolby Atmos / DTS:X

## Soundbar

- Power supply: AC 100-240V~50/60Hz
- Power consumption: 58W
- Power consumption at standby mode:  $\leq 0.5W$
- Impedance:  $8\Omega \times 7$
- Frequency response: 160Hz-20KHz
- Dimensions (WxHxD): 1050 x 65 x 120 (mm)
- Weight: 4.1 kg
- Operating temperature:  $0^{\circ}C - 45^{\circ}C$

## Wireless subwoofer

- Power supply: AC 100-240V~50/60Hz
- Power consumption: 40W
- Power consumption at standby mode:  $\leq 0.5W$
- Impedance:  $3\Omega$
- Frequency response: 40 Hz-120 Hz
- Frequency range: 5732MHz-5848MHz
- Max transmitting power: 13dBm
- Dimensions (WxHxD): 240 x 400 x 365mm
- Weight: 7.8 kg

## Satellite speakers

- Power supply: DC 24V --- 1.5A
- Power consumption: 20W
- Power consumption at standby mode:  $\leq 0.5W$
- Impedance:  $8\Omega \times 4 (2^*2)$
- Frequency response: 40 Hz-120 Hz
- Frequency range: 5732MHz-5848MHz
- Max transmitting power: 13dBm
- Dimensions (WxHxD): 96 x 120 x 160 (mm)
- Weight: 0.96 kg

## Bluetooth

- Bluetooth version: 5.0, Bluetooth profile - Bluetooth stereo supported (Advanced Audio Distribution Profile - A2DP; Audio Video Remote Control Profile - AVRCP)

- Frequency range: 2402 Mhz – 2480 Mhz
- Max transmitting power: 15dBm

### Remote control

- Distance/Angle: 6m/ 30°
- Battery type: 1.5V AAA battery x 2, user replaceable.

### Wi-Fi

WLAN Standard	IEEE802.11a/b/g/n/ac
Security	WPA2TM/WPATM
Frequency range	2.4 GHz band (1-13 ch)/5 GHz band

#### For EU

2412 MHz to 2472 MHz  
 5180 MHz to 5320 MHz  
 5500 MHz to 5700 MHz  
 5745 MHz to 5850 MHz

Maximum power(EIRP) 20 dBm

## 6 Notice

### Disposal of your old product and battery



Your product is designed and manufactured with high quality materials and components, which can be recycled and reused.

#### Remove the disposable battery

To remove the disposable batteries, see the section ‘Install/replace the remote control battery’.

#### Environmental protection and sustainability

We have omitted all unnecessary packaging and make sure it is eco-friendly and sustainable.

---

## Trademarks

---



The Bluetooth® word mark and logos are registered trademarks owned by Bluetooth SIG, Inc. and any use of such marks by TTE Corporation is under license. Other trademarks and trade names are those of their respective owners.

---



For DTS patents, see <http://patents.dts.com>. Manufactured under license from DTS, Inc. (for companies headquartered in the U.S./Japan/Taiwan) or under license from DTS Licensing Limited (for all other companies). DTS, DTS:X, the DTS:X logo, DTS, DTS Play-Fi, Play-Fi and the DTS Play-Fi and Play-Fi logos are registered trademarks or trademarks of DTS, Inc. in the United States and other countries. © 2022 DTS, Inc. ALL RIGHTS RESERVED.

---



To control this AirPlay 2-enabled speaker, iOS 11.4 or later is required. Apple, AirPlay, iPad, iPad Air, iPad Pro, and iPhone are trademarks of Apple Inc., registered in the U.S. and other countries.

---



The Spotify Software is subject to third party licenses found here: <https://www.spotify.com/connect/third-party-licenses>



Google and Chromecast built-in are trademarks of Google LLC.

---



The Adopted Trademarks HDMI, HDMI High-Definition Multimedia Interface, and the HDMI Logo are trademarks or registered trademarks of HDMI Licensing Administrator, Inc. in the United States and other countries.

---



Google and Chromecast built-in are trademarks of Google LLC.

---

COMPATIBLE WITH



Dolby, Dolby Vision, Dolby Atmos, and the double-D symbol are registered trademarks of Dolby Laboratories Licensing Corporation. Manufactured under license from Dolby Laboratories. Confidential unpublished works. Copyright © 2012–2022 Dolby Laboratories. All rights reserved.

---



Amazon, Alexa and all related logos are trademarks of Amazon.com, Inc. or its affiliates.

# 7 FAQ

## No power

- Make sure the AC power cord and AC input connector are connected properly.
- Make sure there is power supply.
- Make sure the Soundbar has turned on.

## No sound

- Make sure the audio cable is connected to the Soundbar and your device.
- Make sure you have selected the correct source.
- Press up button to increase the volume level.
- Make sure the Soundbar is not muted.

## Low voice

- Use the remote control to adjust the volume.
- May open Night mode, please press  and use up/down button to exit the Night mode.

\* Other EQs cannot be selected in Night Mode.

## The remote control does not work.

- Make sure you have selected the correct source.
- Make sure the distance of remote control and the Soundbar is within operational range.
- Make sure the battery is correctly inserted and is working.
- Make sure the remote control is close to the remote control sensor of the Soundbar.

## I hear distorted sound.

- Make sure all cables are properly connected.
- Make sure you have selected the correct source.
- Make sure the TV is muted if you play audio from the TV.

## I cannot find the Bluetooth name of this Soundbar on my Bluetooth device.

- Make sure the Bluetooth function is activated on your Bluetooth device.
- Make sure the Soundbar has paired with your Bluetooth device.



**TCL support:**

Please visit [www.tcl.com/au](http://www.tcl.com/au) & [www.tclelectronics.co.nz](http://www.tclelectronics.co.nz)

---

**WE ARE  
READY TO**

**HELP** contact us first  
with any questions



**TAKE CARE WHEN  
REMOVING THE Soundbar**

Copyright © 2023 TCL. All rights reserved.

X937U\_AU\_UM\_V1.1