

Whirlpool®

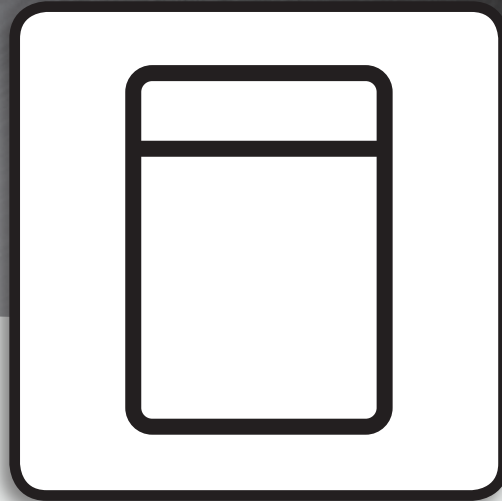

**Health & Safety, Use & Care and Installation guide**



**THANK YOU FOR BUYING A WHIRLPOOL PRODUCT.**

In order to receive a more complete assistance, please register your appliance on:  
[www.whirlpool.com.au](http://www.whirlpool.com.au)

Index

**Health and Safety guide..... 3**

***Use and Care guide***

**PRODUCT DESCRIPTION ..... 5**

APPLIANCE ..... 5

CONTROL PANEL..... 5

**FIRST TIME USE ..... 6**

REFINED SALT AND RINSE AID ..... 6

DETERGENT ..... 6

**PROGRAMS TABLE..... 7**

PROGRAMS DESCRIPTION ..... 7

**OPTIONS AND FUNCTIONS ..... 8**

**DAILY USE ..... 9**

**ADVICE AND TIPS ..... 9**

**LOADING THE RACKS ..... 10**

UPPER RACK..... 10

LOWERRACK..... 10

**CARE AND MAINTENANCE ..... 11**

CLEANING DISHWASHER ..... 11

CLEANING THE SPRAY ARMS ..... 11

CLEANING THE WATER INLET HOSE..... 11

CLEANING THE WATER INLET HOSE..... 11

**TROUBLESHOOTING..... 12**

**INSTALLATION ..... 13**

**AFTER-SALES SERVICE ..... 14**

***Installation Guide ..... 15***

**IMPORTANT TO BE READ AND OBSERVED**

Before using the appliance, read these safety instructions. Keep them nearby for future reference. These instructions and the appliance itself provide important safety warnings, to be observed at all times. The manufacturer declines any liability for failure to observe these safety instructions, for inappropriate use of the appliance or incorrect setting of controls.

**⚠** Very young children (0-3 years) should be kept away from the appliance. Young children (3-8 years) should be kept away from the appliance unless continuously supervised. Children from 8 years old and above and persons with reduced physical, sensory or mental capabilities or lack of experience and knowledge can use this appliance only if they are supervised or have been given instructions on safe use and understand the hazards involved. Children must not play with the appliance. Cleaning and user maintenance must not be carried out by children without supervision.

**PERMITTED USE**

**⚠** CAUTION: The appliance is not intended to be operated by means of an external switching device, such as a timer, or separate remote controlled system.

**⚠** This appliance is intended to be used in household and similar applications such as: staff kitchen areas in shops, offices and other working environments; farm houses; by clients in hotels, motels, bed & breakfast and other residential environments.

**⚠** The maximum number of place settings is shown in the product sheet.

**⚠** The door should not be left in the open position - risk of tripping. The open appliance door can only support the weight of the loaded rack when pulled out. Do not rest objects on the door or sit or stand on it.

**⚠** **WARNING** : Dishwasher detergents are strongly alkaline. They can be extremely dangerous if swallowed. Avoid contact with the skin and eyes and keep children away from the dishwasher when the door is open. Check that the detergent receptacle is empty after completion of the wash cycle.

**⚠** **WARNING** : Knives and other utensils with sharp points must be loaded in the basket with their points down or placed in a horizontal position - risk of cuts.

**⚠** This appliance is not for professional use. Do not use the appliance outdoors. Do not store explosive or flammable substances (e.g. gasoline or aerosol cans) inside or near the appliance - risk of fire. The appliance must be used only to wash domestic dishes in accordance with the instructions in this manual. The water in the appliance is not potable. Use only

detergent and rinse additives designed for an automatic dishwasher. When adding a water softener (salt), run one cycle immediately with the machine empty, to avoid corrosion damage to internal parts. Store the detergent, rinse aid and salt out of reach of children. Shut off the water supply and unplug or disconnect the power before servicing and maintenance. Disconnect the appliance in the event of any malfunction.

**INSTALLATION**

**⚠** The appliance must be handled and installed by two or more persons - risk of injury. Use protective gloves to unpack and install - risk of cuts. Connect the dishwasher to the water mains using only new hose sets. The old hose sets should not be reused. All hoses must be securely clamped to prevent them coming loose during operation. All local waterboard regulations must be complied with. Water supply pressure 0.05 - 1.0 MPa. The appliance must be placed against the wall or built into furniture to limit the access to its rearside. For dishwashers having ventilation openings in the base, the openings must not be obstructed by a carpet.

**⚠** Installation, including water supply (if any) and electrical connections, and repairs must be carried out by a qualified technician. Do not repair or replace any part of the appliance unless specifically stated in the user manual. Keep children away from the installation site. After unpacking the appliance, make sure that it has not been damaged during transport. In the event of problems, contact the dealer or your nearest After-sales Service. Once installed, packaging waste (plastic, styrofoam parts etc.) must be stored out of reach of children - risk of suffocation. The appliance must be disconnected from the power supply before any installation operation - risk of electrical shock. During installation, make sure the appliance does not damage the power cable - risk of fire or electrical shock. Only activate the appliance when the installation has been completed.

If installing the dishwasher at the end of a row of units making the side panel accessible, the hinge area must be covered to avoid risk of injury. The inlet water temperature depends on the dishwasher model. If the installed inlet hose is marked „25°C Max”, the maximum allowed water temperature is 25°C. For all other models the maximum allowed water temperature is 60°C. Do not cut hoses and, in the case of appliances fitted with a waterstop system, do not immerse the plastic casing containing the inlet hose in water. If hoses are not long enough, contact your local dealer. Make sure the inlet and drain hoses

---

are kink-free and are not crushed. Before using the appliance for the first time, check the water inlet and drain hose for leaks. Make sure that the four feet are stable and resting on the floor, adjusting them as required, and check that the dishwasher is perfectly levelled using a spirit level.

### **ELECTRICAL WARNINGS**

The rating plate is on the edge of the dishwasher door (visible when the door is open).

 It must be possible to disconnect the appliance from the power supply by unplugging it if plug is accessible, or by a multi-pole switch installed upstream of the socket and the appliance must be earthed, in conformity with national electrical safety standards.

 Do not use extension leads, multiple sockets or adapters. The electrical components must not be accessible to the user after installation. Do not use the appliance when you are wet or barefoot. Do not operate this appliance if it has a damaged power cable or plug, if it is not working properly, or if it has been damaged or dropped.

 If the supply cord is damaged, it must be replaced with an identical one by the manufacturer, its service agent or similarly qualified persons in order to avoid a hazard - risk of electrical shock.

If the fitted plug is not suitable for your socket outlet, contact a qualified technician. Do not pull the power supply cable. Do not immerse the mains cord or plug in water. Keep the cord away from hot surfaces.

### **CLEANING AND MAINTENANCE**

 **WARNING : Ensure that the appliance is switched off and disconnected from the power supply before performing any maintenance operation - risk of electrical shock. Never use steam cleaning equipment.**

### **DISPOSAL OF PACKAGING MATERIALS**

The packaging material is 100% recyclable and is marked with the recycle symbol . The various parts of the packaging must therefore be disposed of responsibly and in full compliance with local authority regulations governing waste disposal.

### **DISPOSAL OF HOUSEHOLD APPLIANCES**

This appliance is manufactured with recyclable or reusable materials. Dispose of it in accordance with local waste disposal regulations. For further information on the treatment, recovery and recycling of household electrical appliances, contact your local authority, the collection service for household waste or the store where you purchased the appliance. This appliance is marked in compliance

with European Directive 2012/19/EU, Waste Electrical and Electronic Equipment (WEEE). By ensuring this product is disposed of correctly, you will help prevent negative consequences for the environment and human health.

The  symbol on the product or on the accompanying documentation indicates that it should not be treated as domestic waste but must be taken to an appropriate collection center for the recycling of electrical and electronic equipment.

### **ENERGY SAVING TIPS**

ECO: it is the standard cleaning cycle, it is suitable to clean normally soiled tableware and that it is the most efficient programme in terms of its combined energy and water consumption for that type of tableware.

# USE AND CARE GUIDE

Before using the appliance carefully read Health and Safety guide.

## PRODUCT DESCRIPTION

### APPLIANCE

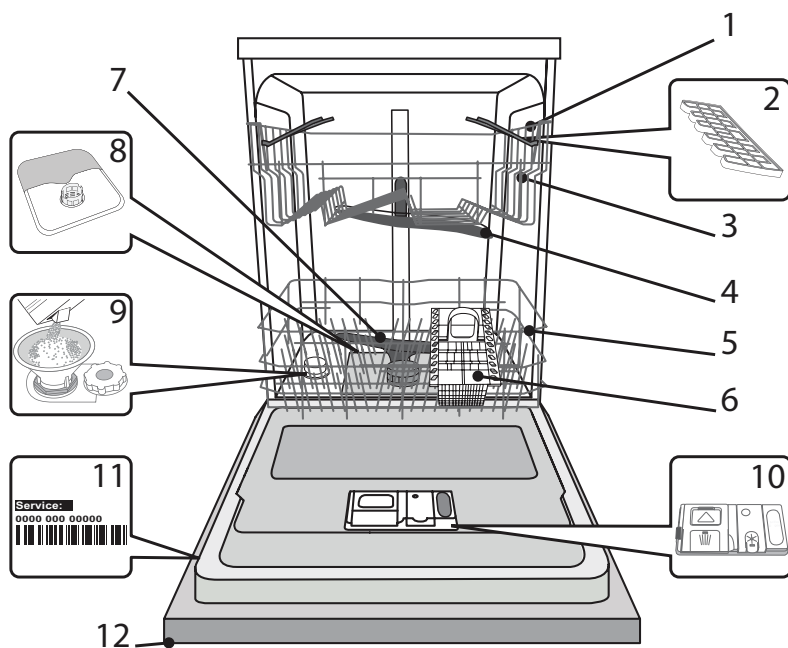

1. Upper rack
2. Foldable flaps
3. Upper rack height adjuster
4. Upper spray arm
5. Lower rack
6. Cutlery basket
7. Lower spray arm
8. Filter Assembly
9. Salt reservoir
10. Detergent and Rinse Aid dispensers
11. Rating plate
12. Control panel

### CONTROL PANEL

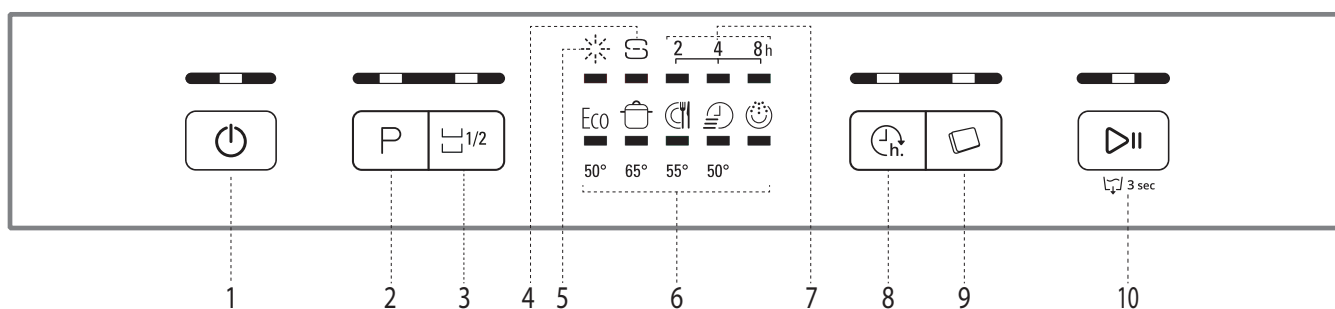

1. On-Off/Reset button with indicator light
2. Program selection button with indicator light
3. Half Load button with indicator light
4. Salt refill indicator light
5. Rinse Aid refill indicator light
6. Program indicator lights
7. Delay indicator light
8. Delay button with indicator light
9. Tablet (Tab) button with indicator light
10. Start/Pause button with indicator light / Drain out

# FIRST TIME USE

## SALT, RINSE AID AND DETERGENT

### ADVICE REGARDING THE FIRST TIME USE

After installation, remove the stoppers from the racks and the retaining elastic elements from the upper rack.

### FILLING THE SALT RESERVOIR

The use of salt prevents the formation of LIMESCALE on the dishes and on the machine's functional components.

- It is important that the salt reservoir be never empty.
- It is important to set the water hardness.

The salt reservoir is located in the lower part of the dishwasher (see *Product Description*) and should be filled when the **SALT REFILL indicator light**  in the control panel is lit.

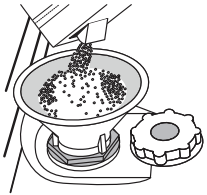

1. Remove the lower rack and unscrew the reservoir cap (anticlockwise).
2. Only the first time you do this: fill the salt reservoir with water.
3. Position the funnel (see figure) and fill the salt reservoir right up to its edge (approximately 1 kg); it is not unusual for a little water to leak out.
4. Remove the funnel and wipe any salt residue away from the opening.

Make sure the cap is screwed on tightly, so that no detergent can get into the container during the wash program (this could damage the water softener beyond repair).

**Whenever you need to add salt, we recommend carrying out the procedure before the washing cycle is started.**

### SETTING THE WATER HARDNESS

To allow the water softener to work in a perfect way, it is essential that the water hardness setting is based on the actual water hardness in your house. This information can be obtained from your local water supplier.

The factory setting is for average (3) water hardness.

- Switch on the appliance by pressing the **ON/OFF** button.
- Switch off the appliance by pressing the **ON/OFF** button.
- Hold down button **START/PAUSE** for 5 seconds, until you hear a beep.
- Switch on the appliance by pressing the **ON/OFF** button.
- The program indicator light of the current set level flashes.

Water Hardness Table			
Level		°dH German degrees	°fH French degrees
1	Soft	0 - 6	0 - 10
2	Medium	7 - 11	11 - 20
3	Average	12 - 17	21 - 30
4	Hard	17 - 34	31 - 60
5	Very hard	35 - 50	61 - 90

• Press button **P** to select the desired hardness level (see *WATER HARDNESS TABLE*).

- Switch off the appliance by pressing the **ON/OFF** button.

Setting is complete!

As soon as this procedure is complete, run a program without loading.

**Only use salt that has been specifically designed for dishwashers.**

After the salt has been poured into the machine, the **SALT REFILL** indicator light switches off.

**If the salt container is not filled, the water softener and the heating element may be damaged as a result.**

### FILLING THE RINSE AID DISPENSER

Rinse aid makes dish **DRYING** easier. The rinse aid dispenser **A** should be filled when the **RINSE AID REFILL**  indicator light in the control panel is lit.

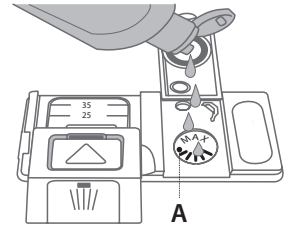
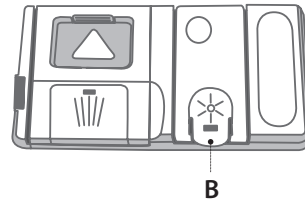

1. Open the dispenser **B** by pressing and pulling up the tab on the lid.
2. Pour in the rinse aid (max.110 ml), making sure it does not overflow from the dispenser. If this happens, clean the spill immediately with a dry cloth.
3. Press the lid down until you hear a click to close it.

**NEVER pour the rinse aid directly into the appliance tub.**

### ADJUSTING THE DOSAGE OF RINSE AID

If you are not completely satisfied with the drying results, you can adjust the quantity of rinse aid used.

- Switch the dishwasher on using the **ON/OFF** button.
- Switch it off using the **ON/OFF** button.
- Press button **START/PAUSE** three times - a beep will be heard.
- Switch it on using the **ON/OFF** button.
- The program indicator light of the current set level flashes.
- Press button **P** to select the level of rinse aid quantity to be supplied.
- Switch it off using the **ON/OFF** button

Setting is complete!

If the rinse aid level is set to ZERO (ECO), no rinse aid will be supplied. The **LOW RINSE AID** indicator light will not be lit if you run out of rinse aid. A maximum of 4 levels can be set according to the dishwasher model. The factory setting is for a medium level.

- If you see bluish streaks on the dishes, set a low number (1-2).
- If there are drops of water or limescale marks on the dishes, set a mid-range number (3-4).

### FILLING THE DETERGENT DISPENSER

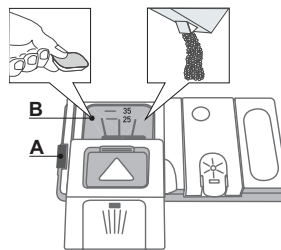

**To open the detergent dispenser use the opening device A. Introduce the detergent into the dry dispenser B only. Place the amount of detergent for pre-washing directly inside the tub.**

1. When measuring out the detergent refer to the mentioned earlier information to add the proper quantity. Inside the dispenser **B** there are indications to help



















the detergent dosing.

2. Remove detergent residues from the edges of the dispenser and close the cover until it clicks.
3. Close the lid of the detergent dispenser by pulling it up until the closing device is secured in place.

The detergent dispenser automatically opens up at the right time according to the program.

If all-in-one detergents are used, we recommend using the **TABLET** button, because it adjusts the program so that the best washing and drying results are always achieved.

# PROGRAMS TABLE

Program		Drying	Available options *)	Detergent container		Duration of wash program (h:min)**)	Water consumption (litres/cycle)	Energy consumption (kWh/cycle)	
				Tub	B				
1. Eco	 ECO	50°	✓	 1/2  	-	✓	2:00	16	1,35
2. Intensive		65°	✓	 1/2  	-	✓	2:30	16,5	1,65
3. Normal		55°	✓	 1/2  	✓	✓	2:40	12,5	0,86
4. Express 30'		50°	-	 	-	✓	0:30	8,5	0,50
5. Soak		-	-	 1/2 	-	-	0:10	4	0,01

Not all options can be used simultaneously.

\*\*\*) The duration of the program shown on the display or in the booklet is an estimate calculated on standard conditions. The actual time may vary depending on many factors such as temperature and pressure of the incoming water, room temperature, amount of detergent, quantity and type of load, load balancing, additional selected options and sensor calibration. The sensor calibration can increase program duration up to 20 min.

Standby consumption: Left-on mode consumption: 5 W - Off mode consumption: 0.5 W

The NORMAL wash cycle adheres to the regulation standard AS/NZS 2007. Although it has a longer duration than other wash cycles it uses less energy and is less harmful to the environment.

**WARNING: Dishwasher detergents are strongly alkaline. They can be extremely dangerous if swallowed. Avoid contact with the skin and eyes and keep children away from the dishwasher when the door is open. Check that the detergent receptacle is empty after completion of the wash cycle**

## PROGRAMS DESCRIPTION

### Instructions on wash cycle selection.

#### ECO

Everyday cycle, that ensures optimal cleaning performance in shorter time.

#### INTENSIVE

Heavily soiled dishes and pans (not to be used for delicate items).

#### NORMAL

Normally soiled crockery. Standard daily wash cycle.

#### EXPRESS 30'

Program to be used for lightly-soiled dishes with no dried food residues. (Ideal for 2 place settings).

#### SOAK

Crockery to be washed later. No detergent to be used with this program.

### Notes:

Optimum performance levels when using the "Express 30'" program can be achieved by observing the maximum amounts of specified place settings.

**To reduce consumption even further, only run the dishwasher when it is full.**

# OPTIONS AND FUNCTIONS

OPTIONS can be selected directly by pressing the corresponding button (see *CONTROL PANEL*).

**If an option is not compatible with the selected program see *PROGRAMS TABLE*, the corresponding LED flashes rapidly 3 times and beeps will sound. The option will not be enabled.**



## DELAY

It is possible to delay the start time of the program by **2, 4 or 8** hours:

1. After selecting the desired program and any other options, press the DELAY button. The indicator light will go on.
2. Select the desired delay time by pressing the DELAY button repeatedly. The 2 hours, 4 hours and 8 hours indicator lights will go on in succession. If the DELAY button is pressed again, the option is deselected and the indicator light goes off.
3. After the selection process, the countdown will begin if the START/PAUSE button is pressed. The selected delay period indicator light flashes and the START/PAUSE button stops flashing (fixed light).
4. Once this time has elapsed, the DELAY indicator light goes off and the program begins.

**The Delay function cannot be set once a wash cycle has been started.**



## HALF LOAD

If there are not many dishes to be washed, a half load cycle may be used in order to save water, electricity and detergent. Select the program and press the HALF LOAD button: the indicator light will light up. Press the HALF LOAD button to deselect this option.

**Remember to halve the amount of detergent.**



## TABLET

This setting allows you to optimize the performance of the program according to the type of detergent used. Press the TABLET button (the indicator light will light up) if you use combined detergents in tablet form (rinse aid, salt and detergent in 1 dose).

**If you use powder or liquid detergent, this option should be off.**



## DRAIN OUT

To stop and cancel the active cycle, the Drain Out function can be used.

A long press of START/PAUSE button, will activate the DRAIN OUT function. The active program will be stopped and the water in the dishwasher will be drained out.



## DAILY USE

### 1. CHECK WATER CONNECTION

Check that the dishwasher is connected to the water supply and that the tap is open.

### 2. SWITCH ON THE DISHWASHER

Press the **ON/OFF** button.

### 3. LOAD THE RACKS (see *LOADING THE RACKS*).

### 4. FILLING THE DETERGENT DISPENSER

(see *PROGRAMS TABLE*).

### 5. CHOOSE THE PROGRAM AND CUSTOMISE THE CYCLE

Select the most appropriate program in accordance with the type of crockery and its soiling level (see *PROGRAMS DESCRIPTION*) by pressing the **P** button.

Select the desired options (see *OPTIONS AND FUNCTIONS*).

### 6. START

Start the wash cycle by pressing the **START/PAUSE** button. When the program starts you hear a beep.

### 7. END OF WASH CYCLE

The end of the wash cycle is indicated by beeps and by the flashing of the wash cycle indicator on the panel.

Open the door and switch off the appliance by pressing the **ON/OFF** button.

Wait for a few minutes before removing the crockery - to avoid burns.

Unload the racks, beginning with the lower one.

**The machine will switch off automatically during certain extended periods of inactivity, in order to minimise electricity consumption. If the crockery is only lightly soiled or if it has been rinsed with water before being placed in the dishwasher, reduce the amount of detergent used accordingly.**

### MODIFYING A RUNNING PROGRAM

If a wrong program was selected, it is possible to change it, provided that it has only just begun: press and hold the **ON/OFF** button, the machine will switch off.

Switch the machine back on using the **ON/OFF** button and select the new wash cycle and any desired options; start the cycle by pressing the **START/PAUSE** button.

### ADDING EXTRA CROCKERY

Without switching off the machine, open the door (**be ware of HOT steam!**) and place the crockery inside the dishwasher. Close the door and press the **START/PAUSE** button the cycle will begin from the point at which it was interrupted.

### ACCIDENTAL INTERRUPTIONS

If the door is opened during the wash cycle, or if there is a power cut, the cycle stops. Once the door has been closed or the electricity supply is restored, to start again the cycle from where it was interrupted, press the **START/PAUSE** button.

*For more information about the functions, you can request or download from the WEB a Use & Care Guide by following the instructions on the last page.  www*

## ADVICE AND TIPS

### TIPS

Before loading the baskets, remove all food residues from the crockery and empty the glasses. **You do not need to rinse beforehand under running water.**

Arrange the crockery so that it is held in place firmly and does not tip over; and arrange the containers with the openings facing downwards and the concave/convex parts placed obliquely, thus allowing the water to reach every surface and flow freely.

**Warning:** lids, handles, trays and frying pans do not prevent the sprayer arms from rotating. Place any small items in the cutlery basket. Very soiled dishes and pans should be placed in the lower basket because in this sector the water sprays are stronger and allow a higher washing performance.

After loading the appliance, make sure that the sprayer arms can rotate freely.

### HYGIENE

To avoid odour and sediment which can be accumulated in the dishwasher please run a high temperature program at least one a month. Use a tea spoon of detergent and run it without the loading to clean your appliance.

### UNSUITABLE CROCKERY

- Wooden crockery and cutlery.
- Delicate decorated glasses, artistic handicraft and antique crockery. Their decorations are not resistant.
- Parts in synthetic material which do not withstand high temperatures.
- Copper and tin crockery.
- Crockery soiled with ash, wax, lubricating grease or ink. The colours of glass decorations and aluminium/silver pieces can change and fade during the washing process. Some types of glass (e.g. crystal objects) can become opaque after a number of wash cycles too.

### DAMAGE TO GLASS AND CROCKERY

- Only use glasses and porcelain guaranteed by the manufacturer as dishwasher safe.
- Use a delicate detergent suitable for crockery.
- Collect glasses and cutlery from the dishwasher as soon as the wash cycle is over.

# LOADING THE RACKS

## UPPER RACK

Load delicate and light dishes: glasses, cups, saucers, low salad bowls.

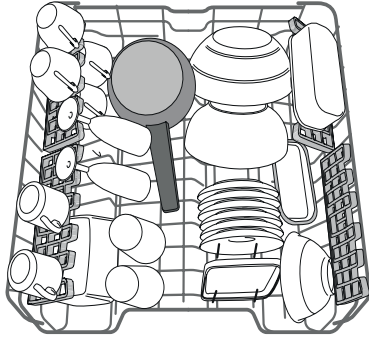

(loading example for the upper rack)

## ADJUSTING THE HEIGHT OF THE UPPER RACK

The height of the upper rack can be adjusted: high position to place bulky crockery in the lower basket and low position to make the most of the tip-up supports by creating more space upwards and avoid collision with the items loaded into lower rack. The upper rack is equipped with a Upper Rack height adjuster (see figure), without pressing the levers, lift it up by simply holding the rack sides, as soon as the rack is stable in its upper position.

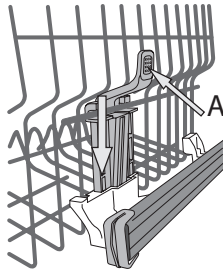

To restore to the lower position, press the levers **A** at the sides of the rack and move the basket downwards.

**We strongly recommend that you do not adjust the height of the rack when it is loaded.**

**NEVER raise or lower the basket on one side only.**

## FOLDABLE FLAPS WITH ADJUSTABLE POSITION

The side foldable flaps can be positioned at three different heights to optimize the arrangement of crockery inside the rack. Wine glasses can be placed safely in the foldable flaps by inserting the stem of each glass into the corresponding slots. For optimum drying results incline the foldable flaps more. To change the inclination, pull up the foldable flap, slide it slightly and position it as you wish.

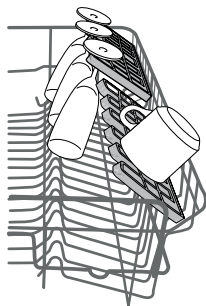

## LOWER RACK

For pots, lids, plates, salad bowls, cutlery etc. Large plates and lids should ideally be placed at the sides to avoid interferences with the spray arm. The lower rack has tip-up supports which can be used in a vertical position when arranging plates or in a horizontal position (lower) to load pans and salad bowls easily.

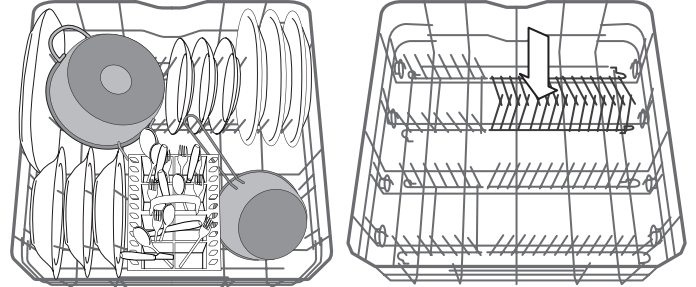

(loading example for the lower rack)

## CUTLERY BASKET

The modular basket is equipped with top grilles for improved cutlery arrangement. The cutlery basket should be positioned only at the front of the lower rack.

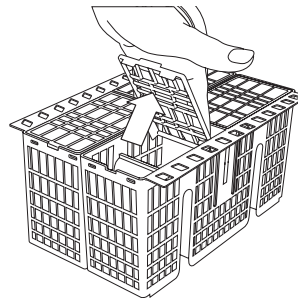

**Knives and other utensils with sharp edges must be placed in the cutlery basket with the points facing downwards or they must be positioned horizontally in the tip-up compartments on the upper rack.**

# CARE AND MAINTENANCE

**ATTENTION:** Always unplug the appliance when cleaning it and when performing maintenance work. Do not use flammable liquids to clean the machine.

## CLEANING THE DISHWASHER

Any marks on the inside of the appliance may be removed using a cloth dampened with water and a little vinegar.

The external surfaces of the machine and the control panel can be cleaned using a non-abrasive cloth which has been dampened with water. Do not use solvents or abrasive products.



## PREVENTING UNPLEASANT ODOURS

Always keep the door of the appliance ajar in order to avoid moisture from forming and being trapped inside the machine.

Clean the seals around the door and detergent dispensers regularly using a damp sponge. This will avoid food becoming trapped in the seals, which is the main cause behind the formation of unpleasant odours.

## CHEKING THE WATER SUPPLY HOSE

Check the inlet hose regularly for brittleness and cracks. If damaged, replace it by a new hose available through our After-Sales Service or your specialist dealer. Depending on the hose type:

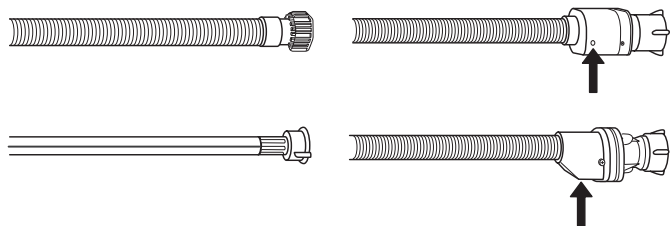

If the inlet hose has a transparent coating, periodically check if the colour intensifies locally. If yes, the hose may have a leak and should be replaced.

For water stop hoses: check the small safety valve inspection window (see arrow). If it is red, the water stop function was triggered, and the hose must be replaced by a new one.

For unscrewing this hose, press the release button while unscrewing the hose.

## CLEANING THE SPRAY ARMS

On occasions, food residue may become encrusted onto the spray arms and block the holes used to spray the water. It is therefore recommended that you check the arms from time to time and clean them with a small non-metallic brush.

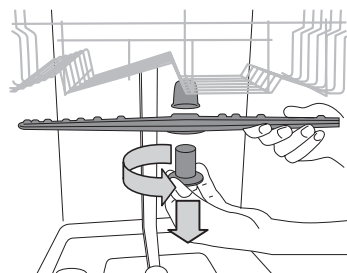

To remove the upper spray arm, turn the plastic locking ring in an anticlockwise direction. The upper spray arm should be replaced so that the side with the greater number of holes is facing upwards.

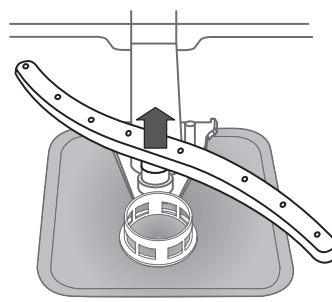

The lower spray arm may be removed by pulling it upwards.

## CLEANING THE FILTER ASSEMBLY

Regularly clean the filter assembly so that the filters do not clog and that the waste water flows away correctly. The filter assembly consists of three filters which remove food residues from the washing water and then recirculate the water: to obtain the best washing results, you need to keep them clean.

**The dishwasher must not be used without filters or if the filter is loose.**

After several washes, check the filter assembly and if necessary clean it thoroughly under running water, using a non-metallic brush and following the instructions below:

1. Turn the cylindrical filter **A** in an anti-clockwise direction and pull it out (Fig 1).
2. Remove the cup filter **B** by exerting a slight pressure on the side flaps (Fig 2).
3. Slide out the stainless-steel plate filter **C** (Fig 3).
4. Inspect the trap and remove any food residues. **NEVER REMOVE** the wash-cycle pump protection (black detail) (Fig 4).

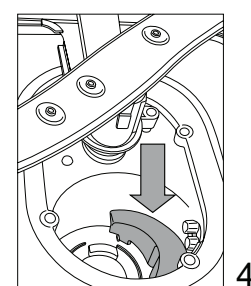
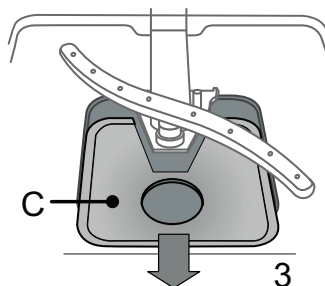
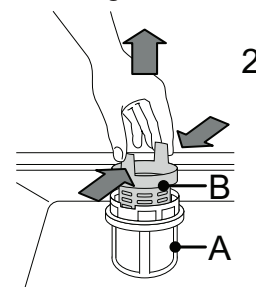
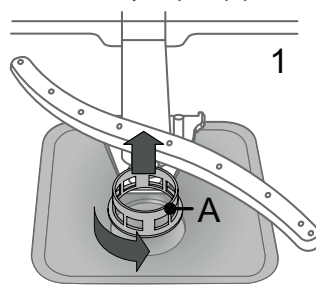

After cleaning the filters, re-place the filter assembly and fix it in position correctly; this is essential for maintaining the efficient operation of the dishwasher.

## CLEANING THE WATER INLET HOSE

If the water hoses are new or have not been used for an extended period of time, let the water run to make sure it is clear and free of impurities before performing the necessary connections. If this precaution is not taken, the water inlet could become blocked and damage the dishwasher.

# TROUBLESHOOTING

Your dishwasher may not work properly.

Before contacting the Service Centre check if the problem can be solved by going through the following list.

PROBLEMS	POSSIBLE CAUSES	SOLUTIONS
The dishwasher won't start or does not respond to commands.	The appliance has not been plugged in properly.	Insert the plug into the socket.
	Power outage.	The dishwasher starts automatically when the power returns.
	The dishwasher door is not closed.	Vigorously push the door until you hear the "click".
	It does not respond to commands.	Switch off the appliance by pressing the <b>ON/OFF</b> button, switch it back on after approximately one minute and reset the program.
The door doesn't lock.	Racks are not fit to the end.	Verify that racks are fit to the end.
	The door is not lock.	Vigorously push the door until you hear the "clack" sound.
The dishwasher won't drain.	The wash cycle has not finished yet.	Wait until the wash cycle finishes.
	The drain hose is bent.	Check that the drain hose is not bent (see <i>INSTALLATION INSTRUCTION</i> ).
	The sink drain pipe is blocked.	Clean the sink drain pipe.
	The filter is clogged up with food residues.	Clean the filter (see <i>CLEANING THE FILTER ASSEMBLY</i> ).
The dishwasher makes excessive noise.	The dishes are rattling against each	Position the crockery correctly (see <i>LOADING THE RACKS</i> ).
	An excessive amount of foam has been produced.	The detergent has not been measured out correctly or it is not suitable for use in dishwashers (see <i>FILLING THE DETERGENT DISPENSER</i> ). Reset dishwasher by pressing the DRAIN button (see <i>OPTIONS AND FUNCTIONS</i> ) and run new program without detergent.
The dishes have not been dried.	The selected program hasn't any drying phase.	Verify on the programs table if the selected program has the drying phase.
	The rinse aid has run out or the resolution is not adequate.	Add the rinse aid or adjust the dosage levels higher (see <i>Filling the Rinse Aid Dispenser</i> ).
	The dishes are made of non-stick or plastic.	It is normal the presence of drops of water (see <i>Tips</i> ).
The dishes are not clean.	The crockery has not been arranged properly.	Arrange the crockery correctly (see <i>LOADING THE RACKS</i> ).
	The spray arms cannot rotate freely, being hindered by the dishes.	Arrange the crockery correctly (see <i>LOADING THE RACKS</i> ).
	The wash cycle is too gentle.	Select an appropriate wash cycle (see <i>PROGRAMS TABLE</i> ).
	An excessive amount of foam has been produced.	The detergent has not been measured out correctly or it is not suitable for use in dishwashers (see <i>FILLING THE DETERGENT DISPENSER</i> ).
	The cap on the rinse aid compartment has not been shut correctly.	Make sure the cap of the rinse aid dispenser is closed.
	The filter is soiled or clogged.	Clean the filter assembly (see <i>CARE AND MAINTENANCE</i> ).
	There is no salt.	Fill the salt reservoir (see <i>FILLING THE SALT RESERVOIR</i> ).
The dishwasher does not fill the water.	No water in the water supply or the tap is closed.	Make sure there is water in the water supply or the tap running.
	The inlet hose is bent.	Make sure the drain hose is not bent (see <i>INSTALLATION</i> ) reprogram the dishwasher and reboot.
	The sieve in the water inlet hose is clogged; it is necessary to clean it	After having carried out the verification and cleaning, turn off and turn on the dishwasher and restart a new program.
The dishes and glasses show calcination or a whitish film.	The salt level is too low.	Fill the salt reservoir (see <i>Filling the Salt Reservoir</i> ).
	The adjustment of the water hardness is not adequate.	Increase the values (see <i>Water Hardness Table</i> ).
	The cap of the salt reservoir is not properly closed.	Check to have properly closed the salt reservoir cap.
	The rinse aid is used up or the dosage is insufficient.	Add the rinse aid or adjust the dosage levels higher.
The dishes and glasses are blue streaked or have a bluish tinge.	The rinse aid dosage is excessive.	Adjust the dosage rates below.

# INSTALLATION

**ATTENTION:** If the appliance must be moved at any time, keep it in an upright position; if absolutely necessary, it may be tilted onto its back.

## CONNECTING THE WATER SUPPLY

Adaptation of the water supply for installation should only be performed by a qualified technician.

The water inlet and outlet hoses may be positioned towards the right or the left in order to achieve the best possible installation.

Make sure the dishwasher does not bend or squash the hoses.

## CONNECTING THE WATER INLET HOSE

- Run the water until it is perfectly clear.
  - Screw the inlet hose tightly into position and turn on the tap.
- If the inlet hose is not long enough, contact a specialist store or an authorised technician.

The water pressure must be within the values indicated in the Technical Data table - otherwise the dishwasher may be function properly. Make sure the hose is not bent or compressed.

WATER SUPPLY	cold or hot (max. 60°C)
WATER INTAKE	3/4"
POWER OF WATER PRESSURE	0,05 ÷ 1 MPa (0.5 ÷ 10 bar) 7,25 – 145 psi

SPECIFICATIONS FOR THE CONNECTION OF THE WATER SUPPLY HOSE:

## CONNECTING THE WATER OUTLET HOSE

Connect the outlet hose to a drain duct with a minimum diameter of 2 cm **A**.

The outlet hose connection must be at a height ranging from 40 to 80 cm from the floor or surface where the dishwasher rests.

Before connecting the water outlet hose to the sink drain, remove the plastic plug **B**.

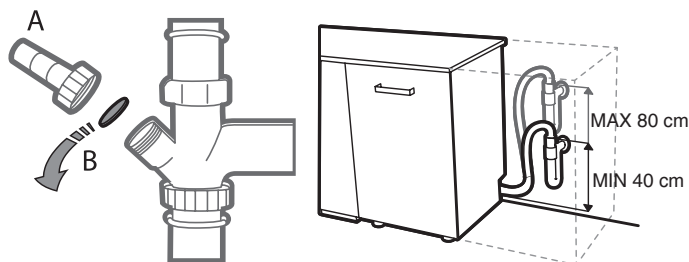

## ANTI-FLOODING PROTECTION

Anti-flooding protection. To ensure floods do not occur, the dishwasher:

- is provided with a special system which blocks the water supply in the event of anomalies or leaks from inside the appliance.

Some models are also equipped with the supplementary safety device **New Aqua Stop**, which guarantees anti-flooding protection even in the event of a supply hose rupture.

Under no circumstances should the water inlet hose be cut as it contains live electrical parts.

## ELECTRICAL CONNECTION

**WARNING: Under no circumstances should the water inlet hose be cut as it contains live electrical parts.**

⚡ Before inserting the plug into the electrical socket, make sure that:

- The socket is **earth**  $\perp$  and complies with current regulations;
- The socket can withstand the maximum load of the appliance as shown on the data plate located on the inside of the door (see *PRODUCT DESCRIPTION*).
- The power supply voltage falls within the values indicated on the data plate on the inside of the door.
- The socket is compatible with the plug of the appliance.

If this is not the case, ask an authorised technician to replace the plug (see *AFTER-SALES SERVICE*). Do not use extension cables or multiple sockets. Once the appliance has been installed, the power supply cable and the electrical socket should be easily accessible.

The cable should not be bent or compressed.

If the power supply cable is damaged, have it replaced by the manufacturer or its authorised Technical Assistance Service in order to prevent all potential hazards.

The Company shall not be held responsible for any incidents, if these regulations are not observed.

## POSITIONING AND LEVELLING

1. Position the dishwasher on a level sturdy floor. If the floor is uneven, the front feet of the appliance may be adjusted until it reaches a horizontal position. If the appliance is levelled correctly, it will be more stable and much less likely to move or cause vibrations and noise while it is operating.
2. Before recessing the dishwasher, stick the adhesive transparent strip under the wooden shelf in order to protect it from any condensation which may form.
3. Place the dishwasher so that its sides or back panel are in contact with the adjacent cabinets or the wall. This appliance can also be recessed under a single worktop.
4. To adjust the height of the rear foot, turn the red hexagonal bushing on the lower central part at the front of the dishwasher using a hexagonal spanner with an opening of 8 mm. Turn the spanner in a clockwise direction to increase the height and in an anticlockwise direction to decrease it.

## DIMENSIONS AND CAPACITY:

WIDTH	600 mm
HEIGHT	850 mm
DEPTH	600 mm
CAPACITY	14 standard place-settings

---

# AFTER-SALES SERVICE

---

## CONTACTING AFTER-SALES SERVICE

When you contact the After-Sales Service, you must provide the codes shown on the rating plate attached to the left or right side inside the door of the dishwasher.

The phone number is listed in the warranty booklet or on the website:

**[www.whirlpool.com.au](http://www.whirlpool.com.au)**

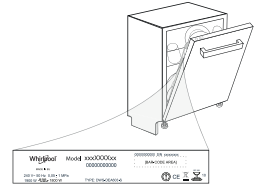

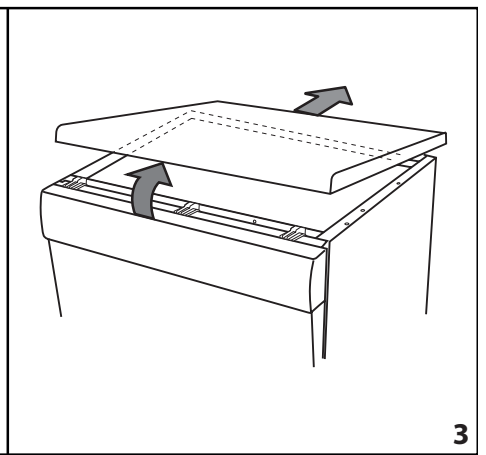
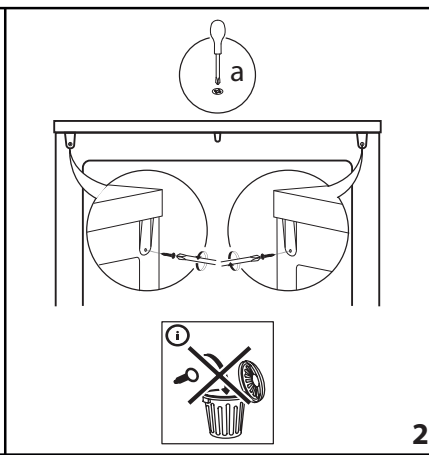
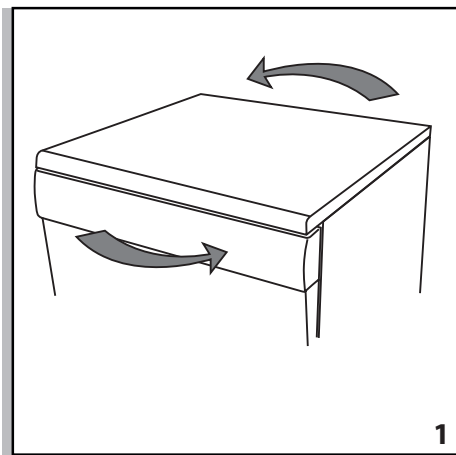
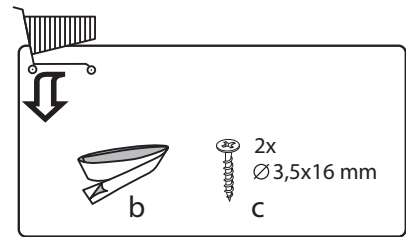
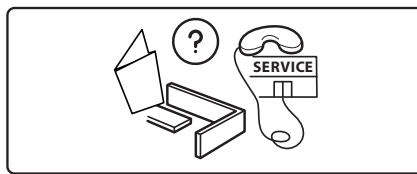
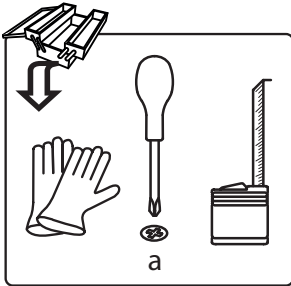
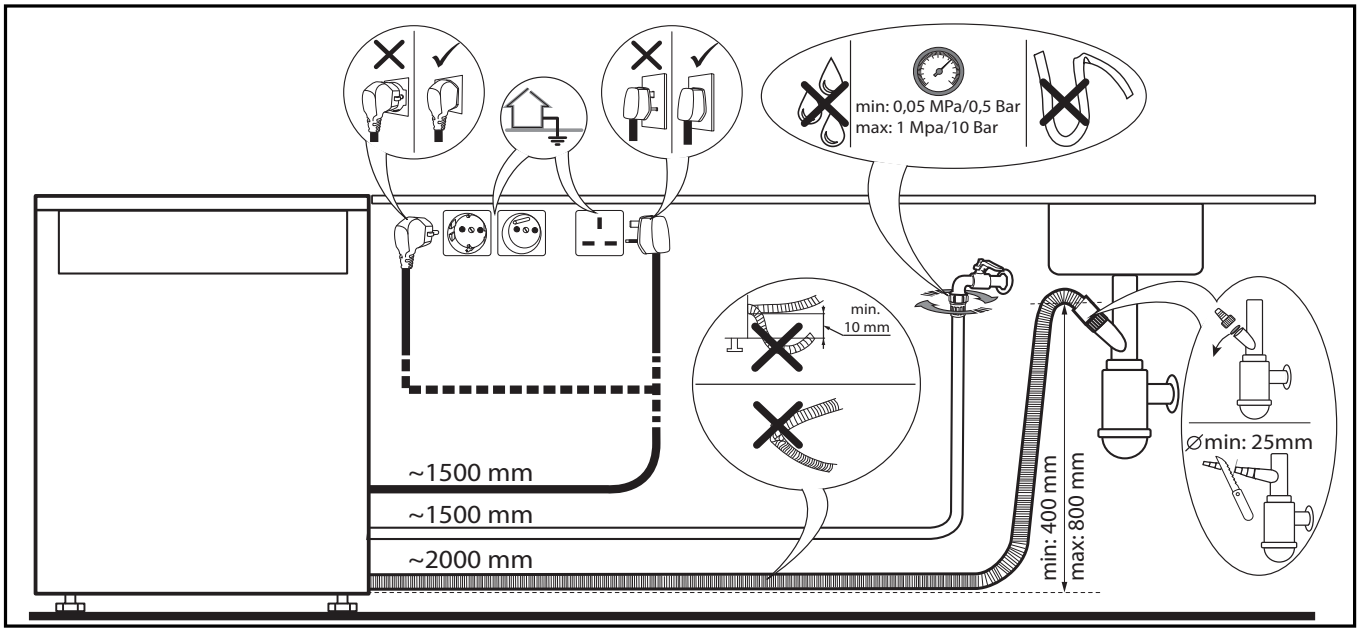
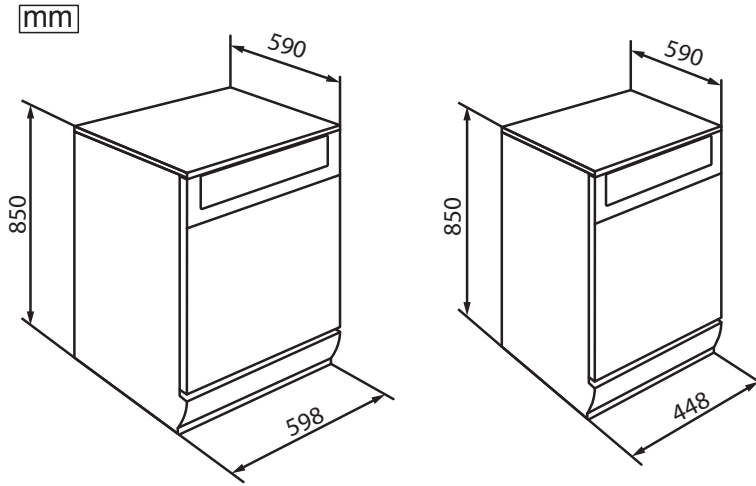

1

2

3

