

SINGLE DOOR FREEZER

WFB2804AB , WFB2804WB

CONGRATULATIONS

Dear customer,

Congratulations on the purchase of your new refrigerator.

Before you use the refrigerator, we recommend that you read through the whole user manual which provides the description of the refrigerator and its functions.

To avoid the risks that are always present when you use an electrical appliance, it is important that the refrigerator is installed correctly and that you read the safety instructions carefully to avoid misuse and hazards.

We recommend that you keep this instruction booklet for future reference and pass it on to any future owners.

After unpacking the appliance, please check it is not damaged. If in doubt, do not use the appliance but contact your local Customer Care Centre.

For contact details, refer to the last page of this user manual.

Conditions of use

This appliance is designed and intended to be used in normal domestic applications only.

Please ensure you read the instruction manual fully before you call for service, or a full service fee could be applicable.

Record model and serial number here:

Model number:.....

Serial number:.....

PNC:.....

CONTENTS

| | |
|------------------------------------|----|
| General warnings..... | 3 |
| Important safety instructions..... | 4 |
| Product description..... | 5 |
| Installing your refrigerator..... | 6 |
| Reversing the door..... | 8 |
| Initial start up..... | 10 |
| Electronic controls..... | 11 |
| Features of the freezer..... | 13 |
| Care and maintenance..... | 14 |
| Food storage tips..... | 15 |
| Noises..... | 16 |
| Troubleshooting..... | 17 |
| Notes..... | 19 |
| Warranty..... | 20 |

Please read the user manual carefully and store in a handy place for later reference.

The symbols you will see in this booklet have these meanings:



WARNING

This symbol indicates information concerning your personal safety.



CAUTION

This symbol indicates information on how to avoid damaging the appliance.



IMPORTANT

This symbol indicates tips and information about use of the appliance.



ENVIRONMENT

This symbol indicates tips and information about economical and ecological use of the appliance.

GENERAL WARNINGS

Please read the user manual carefully and store in a handy place for later reference. Pass the user manual on to possible new owners of the appliance.

Read the following carefully to avoid damage or injury.

Note! You must read these warnings carefully before installing or using the appliance. If you need assistance, contact your Customer Care Department. The manufacturer will not accept liability, should these instructions or any other safety instructions incorporated in this book be ignored.



R600A REFRIGERANT WARNING

- This appliance may contain flammable R600a refrigerant. Avoid safety hazards by carefully installing, handling, servicing and disposing of this appliance. If your appliance contains R600a it will be indicated on the rating plate inside the appliance.
- Ensure that the tubing of the refrigerant circuit is not damaged during transportation and installation.
- In the event any damage accidentally occurs, keep the appliance away from open fires and any devices that produce sparks or arcs and luminaries during normal or abnormal operation, and unplug the appliance at the power point. Call authorised service for necessary action and advice.
- Leaking refrigerant may cause eye injuries or ignite.
- The room for installing appliance must be at least 1m³ per 8g of refrigerant. The amount and type of refrigerant in the appliance can be found on the rating plate inside the appliance.
- Do not damage the refrigerant circuit.
- Do not use electrical appliances inside the food storage compartments of the appliance, unless they are of the type recommended by the manufacturer.



WARNING

It is hazardous for anyone other than an authorised service person to service this appliance. In Queensland the authorised service person MUST hold a gas work authorisation for hydrocarbon refrigerants to carry out servicing or repairs which involve the removal of covers.



WARNING

Risk of suffocation, injury or permanent disability.

- When you dispose of your old refrigerators and freezers, remove any doors. Children can suffocate if they get trapped inside.
- This appliance is not intended for use by persons (including children) with reduced physical, sensory or mental capabilities, or lack of experience and knowledge, unless they have been given supervision or instruction concerning use of the appliance by a person responsible for their safety. Children should be supervised to ensure that they do not play with the appliance.
- Don't use a steam cleaner. If live components come into contact with condensing steam, they may short-circuit or cause an electric shock.
- Do not use mechanical devices or other means to accelerate the defrosting process other than those recommended by the manufacturer.
- This appliance contains insulation formed with flammable blowing gases. Avoid safety hazards by carefully disposing of this appliance.
- If pressurised aerosol containers bear the word 'flammable' and/or a small flame symbol, do not store them inside any refrigerator or freezer. If you do so you may cause an explosion.



WARNING

Risk of fire and electrical shock.

- All electrical connections should be made by a qualified electrician.
- The appliance must be earthed.
- Make sure that the electrical information on the rating plate agrees with the power supply. If not, contact an electrician.
- Connect the mains plug to the mains socket only at the end of the installation. Make sure that there is access to the mains plug after the installation.
- Make sure not to cause damage to the mains plug and to the mains cable. Contact the Service Centre or an electrician to change a damaged mains cable.

GENERAL WARNINGS

Read the following carefully to avoid damage or injury

It is important to use your refrigerator safely. Check these safety points before using your refrigerator.

- The appliance must be plugged into its own dedicated 220-240V, 50Hz AC electrical outlet.
- The plug must be accessible when the refrigerator is in position.
- It is essential the power point is properly earthed to ground. Consult a qualified electrician if you are unsure.
- Don't use extension cords or adapter plugs with this refrigerator.
- If the power cord is damaged, it must be replaced by the manufacturer, its service agent or similarly qualified persons in order to avoid a hazard.
- Never unplug the refrigerator by pulling the electrical cord as this may damage it. Grip the plug firmly and pull straight out.
- Choose a location for your refrigerator that isn't too cold. The ambient room temperature should be above 10°C.
- Stand your refrigerator in a dry place – avoid areas of high moisture or humidity.
- Don't put the refrigerator in frosty or unprotected areas like a garage or on the verandah.
- Don't plug your refrigerator into a timer fitted to the power point.
- Do not put the refrigerator in direct sunlight, near stoves, fires or heaters.
- Do not put the refrigerator on an uneven surface.
- Do not store explosive substances such as aerosol cans with a flammable propellant in this appliance.
- Never try to repair the refrigerator yourself, only use a qualified or authorised service person for repairs.
- When transporting and installing the refrigerator, care should be taken to ensure that no parts of the refrigerating circuit are damaged.

- Keep ventilation openings in the appliance enclosure or in the built-in structure clear of obstruction.
- When installed correctly, your refrigerator should:
 - Have adequate space at the back and sides for air circulation (refer to page 5).
 - Be vertically aligned to the surrounding cupboards.
 - Have doors that will self-close from a partially open position.

Note! You must read these warnings carefully before installing or using the refrigerator. If you need assistance, contact your Customer Care Department. The manufacturer will not accept liability, should these instructions or any other safety instructions incorporated in this book be ignored.

Care and cleaning



WARNING

Risk of injury, fire or damage to the appliance.

- Before maintenance, deactivate the appliance and disconnect the mains plug from the mains socket.
- Regularly clean the appliance to prevent the deterioration of the surface material.
- Do not allow food spills or cleaner residue to accumulate on door sealing surfaces.
- Clean the appliance with a moist soft cloth. Only use neutral detergents. Do not use abrasive products, abrasive cleaning pads, solvents or metal objects.
- Unplug the appliance before cleaning to avoid an electric shock.

Disposal



WARNING

Risk of injury or suffocation through misuse of packaging and/or discarded product.

- Disconnect the appliance from the mains supply.
- Cut off the mains cable and discard it.
- This appliance contains insulation formed with flammable blowing gases. Avoid safety hazards by carefully disposing of this appliance.
- If you wish to discard this refrigerator, please contact your local authorities and ask for the correct method of disposal.
- When you dispose of your old refrigerators and freezers, remove any doors. Children can suffocate if they get trapped inside.

PRODUCT DESCRIPTION

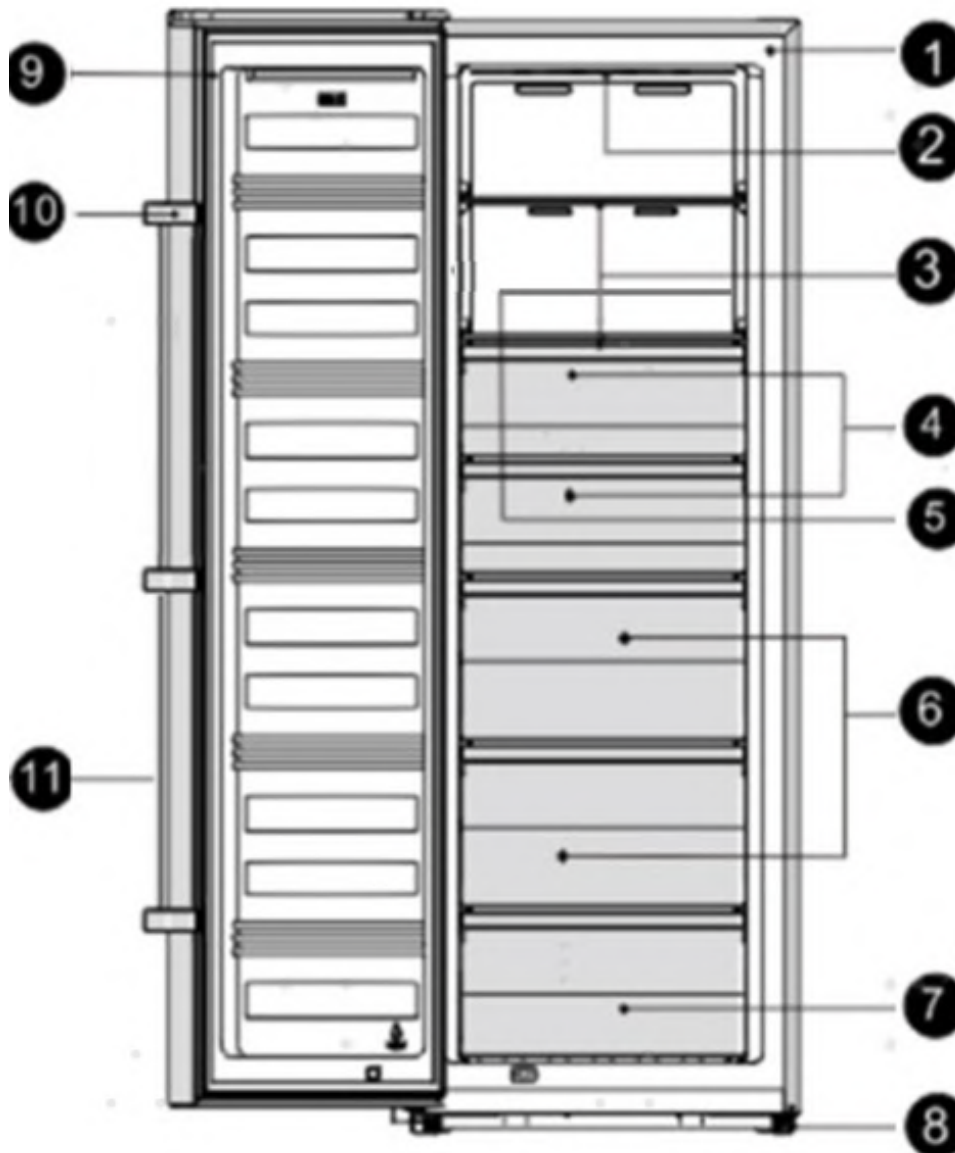

- | | |
|--------------------------|------------------|
| ① Cabinet | ⑨ Freezer door |
| ② LED light | ⑩ Handle |
| ③ Glass shelf | ⑪ Freezer gasket |
| ④ Upper drawer part | |
| ⑤ Display | |
| ⑥ Middle drawer part | |
| ⑦ Lower drawer part | |
| ⑧ Adjustable bottom feet | |

Note! Your refrigerator may differ slightly from this illustration but the functions and operation will remain the same.

Note: To achieve the optimum energy efficiency from this product, please place all shelves, drawers and baskets in their original position as per the illustration above.

INSTALLING YOUR REFRIGERATOR

Adequate ventilation around your refrigerator.

The diagram below shows the recommended airspace to allow for ventilation of your refrigerator.

If you don't have a cupboard with a rear gap, the recommended clearance area on top increases from 50mm to 90mm (x) and from 32mm to 72mm (y). When positioned in a corner area, spacing of at least 350mm on the hinge side will allow the doors to open enough to enable the removal of bins and shelves.

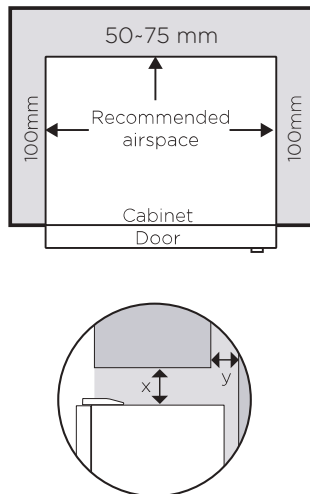

Note: Doors are designed to sit proud of cabinetry (not flush).

The clearances shown above are the recommended minimum clearances. The clearance at the rear must not exceed 75mm.

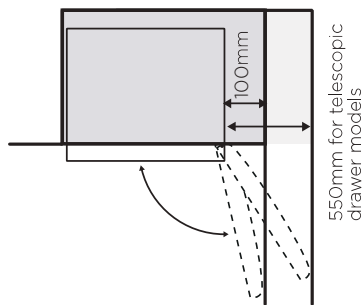

When positioned in a corner area, spacing of at least 350mm on the hinge side will allow the door to open enough to enable the removal of bins and shelves.

Your new refrigerator should arrive with the front adjustable feet wound down, to tilt the top backwards by about 10mm from upright. This will allow your refrigerator door to self-close, providing a consistent closed seal.

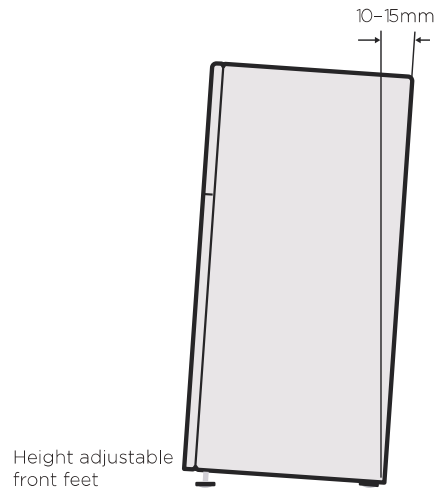

1. Manouver the refrigerator into place.
2. The top of the refrigerator should be tilted back by 10mm (see diagram above). This will allow the doors to self-close providing a consistent door seal.
3. If the refrigerator isn't tilted back, you can adjust the two front feet by hand or with a suitable spanner.
4. Check the alignment of the refrigerator to the surrounding cupboards to see if it is level. You can adjust the level with the feet as detailed in step 3.

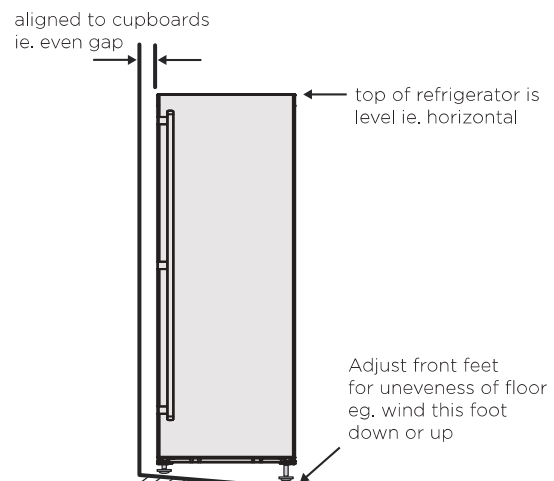











INSTALLING YOUR REFRIGERATOR

5. If you find your refrigerator rocks from corner to corner, it means your floor is uneven. Find a piece of plastic or hardboard etc. and pack it firmly under the the foot until the refrigerator is stable.
6. When you have the appliance in its final position, it needs to be stabilised. Wind the foot down to the floor until it just makes contact with the floor. Lift the front of the appliance to take the weight off the foot, then turn it $\frac{1}{4}$ turn further to ensure firm contact with the floor.
7. Clean your refrigerator thoroughly following the instructions on page 13 and wipe off any dust that has accumulated during shipping.
8. Plug your refrigerator straight into its own powerpoint and never use a double adapter.
9. Before you put any food in your refrigerator, it's recommended you leave it on for 2 or 3 hours to check it is running properly.

Congratulations! You have successfully installed your new refrigerator.

REVERSING THE DOOR

The side in which the door opens can be changed from the left side (as supplied) to the right side, if the installation site allows for it. Tools you will need:

| Not provided | | |
|---|---|---|
|  |  |  |
| 8mm socket wrench | Thin-blade screwdriver | Putty knife |
|  |  |  |
| Cross-shaped screwdriver | Monkey wrench | 7mm wrench |
| Additional parts(In the plastic bag) | | |
|  | | Right Hinge |
|  | | Right Hinge Cover |
|  | | Left Screw Cover |
|  | | Screwdriver |

Note: Before you start lay the freezer on it's back in order to gain access to the base, you should rest it on soft foam packaging or similar material to avoid damaging the backboard of the freezer. To reverse the door. The following steps are generally recommended.

1. Stand the freezer upright.

Remove the screw hole cover and upper hinge cover (left) as follow diagram.

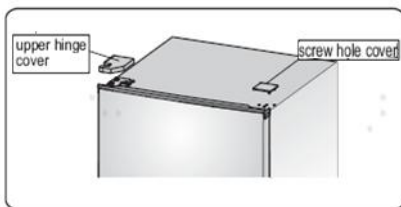

2. Remove the three screws as follow diagram. Lift the left upper hinge part.

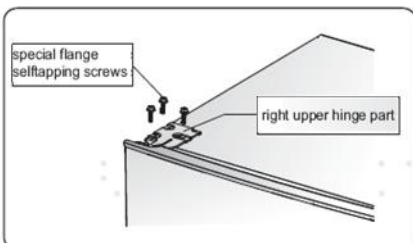

3. Lift the door and place it on a padded surface to prevent scratching.

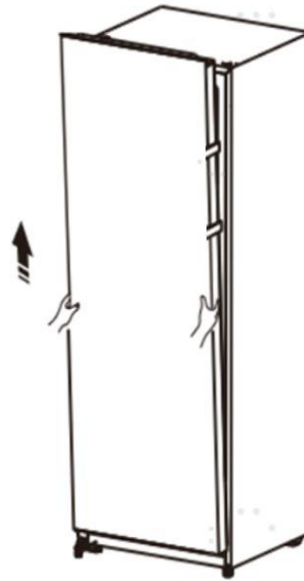

4. Loose screw ③, remove part ① and part ②, then install them to the right side and tighten securely.

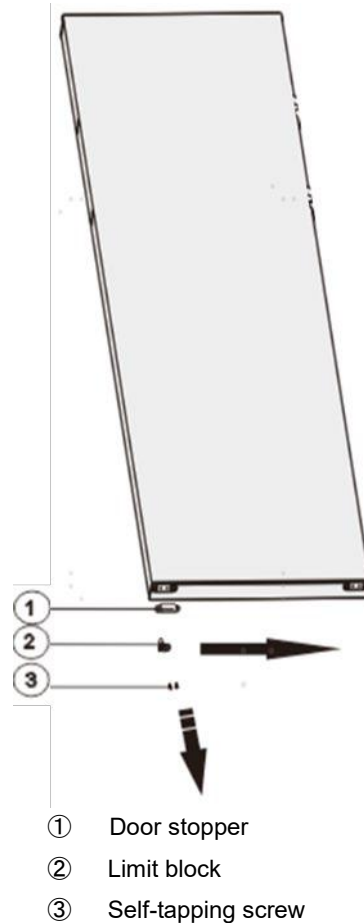

REVERSING THE DOOR (CONTINUED)

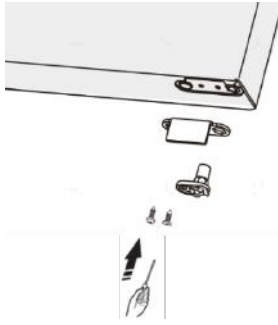

5. Place freezer flatwise, remove part ① and part ②. Loose screw ④ and then remove part ③.

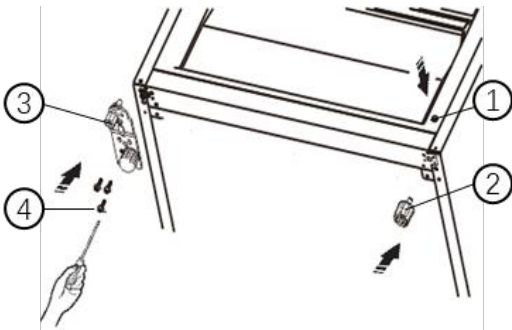

- ① Screw cover
- ② Adjustable bottom feet part
- ③ Right lower hinge part
- ④ Special flange self-tapping screw

6. Just remount to the step 6, change part ① and part ② to left and part ③ to right and then fix part ③ with screws ④.

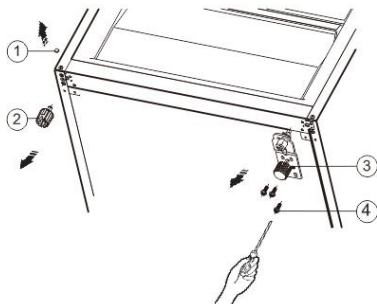

Note: 1. You need move hinge axis from hole ① to ②, move adjustable bottom feet part from hole ③ to ④ before transfer.

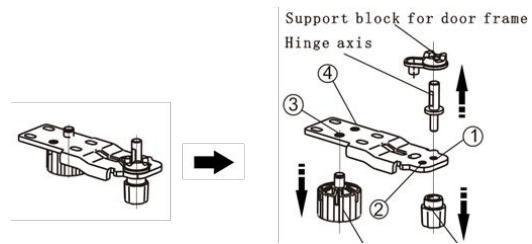

7. Set the door into its new place making sure the pin enters the bushing at the lower frame section.

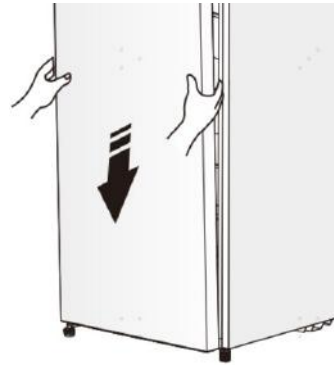

8. Replace the lid by fitting the upper hinge core into the upper door's hole, securing it with the 3 screws.

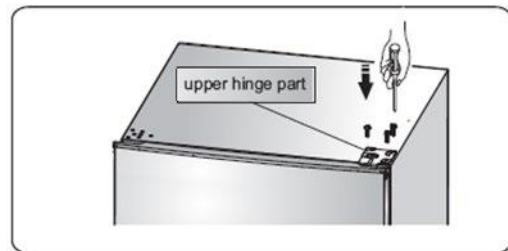

9. Put the screw hole cover and upper hinge cover (right) as follow diagram.

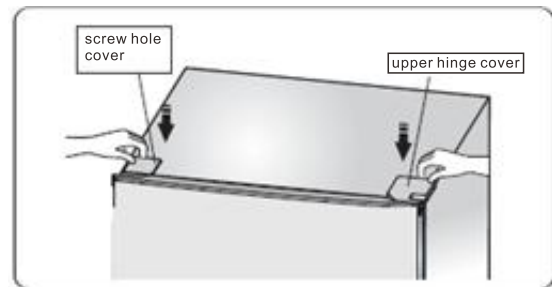

10. Switch the handles from the right to the left (only for the model with handles).

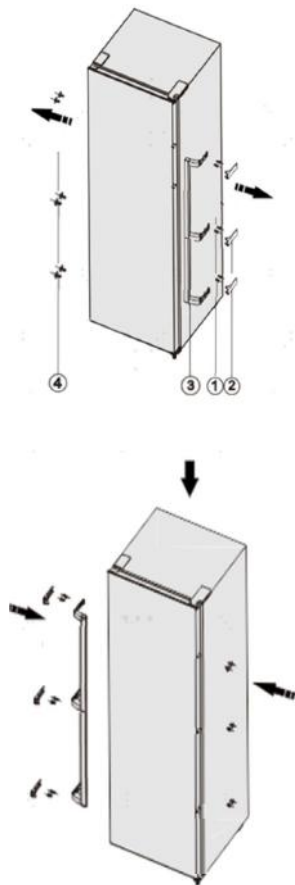

- ① Handle cover
- ② Screw
- ③ Handle part
- ④ Cover-screw cap

Note !

Due to unceasing modification of our products, handle may be slightly different from this instruction manual, but its functions and using methods remain the same. Switch the handles from the right to the left as follow diagram.

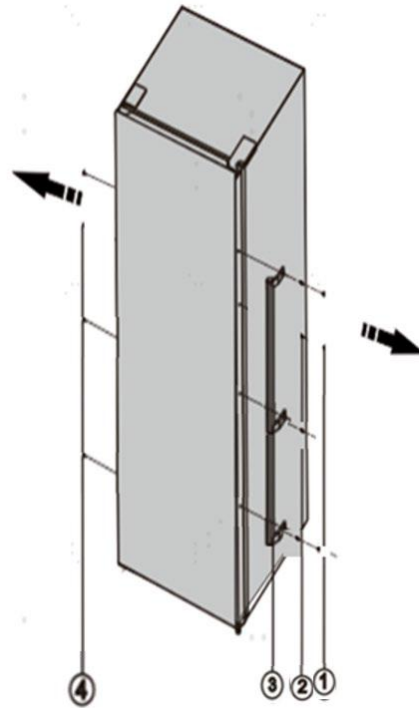
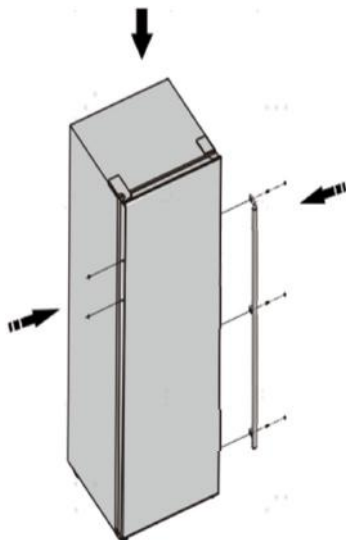

- ① Screw cover
- ② Screw
- ③ Handle part
- ④ Cover-screw cap

Warning !

When changing the side at which the door opens, the appliance must not be connected to the mains. Remove plug from the mains beforehand.

INITIAL START-UP

Refrigerators work by transferring heat from the food inside to the outside air. This operation makes the back and sides of the refrigerator (particularly at start-up) feel warm - which is normal.

A cooling coil is located behind the rear wall of the refrigerator section. This coil cools and removes moisture from the air inside.

Avoid placing food against the air vents in the refrigerator, as it affects the efficient circulation of air.

Your new refrigerator uses a compressor, along with other energy-efficient components, which may make unusual sounds. These sounds simply indicate your refrigerator is working how it should. They include:

- Compressor running noises;
- Air movement noise from the small fan motor;
- A gurgling sound, similar to water boiling;
- A popping noise, heard during automatic defrosting; and
- A clicking noise, prior to compressor start-up.

ELECTRONIC CONTROLS

Use your appliance according to the following control regulations. Your appliance has the corresponding functions and modes as the control panels showed in the pictures below. When the appliance is powered on for the first time, the backlighting of the icons on display panel will start working. If no buttons have been pressed and the doors are closed, the backlighting will turn off.

Note: High temperature setting will accelerate food waste.

Display panel inside

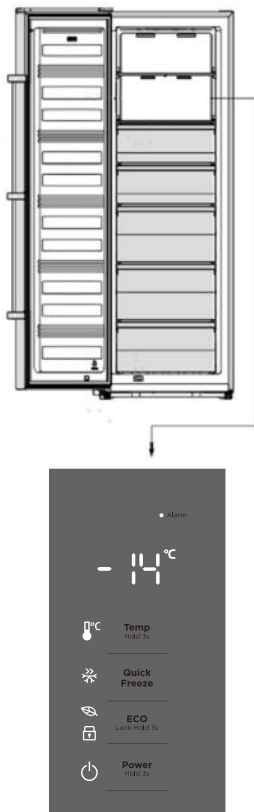

1. Power

To turn the refrigerator on, press the POWER (3secs) button for 3 seconds. Repeat the process to turn the power off.

Important: Do not store any food in the freezer during this time.

2. Temperature

For optimum food preservation, we recommend that when you start your refrigerator for the first time, the temperature for the refrigerator is set to 4°C (39°F). If you want to change the temperature of the refrigerator, follow the instructions below

Ensure the freezer is unlocked by checking that there is no light on ECO (Lock Hold). If the light is on, press and hold for 3 seconds.

To adjust the temperature in Celsius, check that the °C light is on near the temperature display. If the °F is showing, switch the display mode from °C to °F by pressing the TEMP (Hold 3s) button for 3 seconds.

Press the TEMP (Hold 3s), until you select the temperature that you want.

PLEASE NOTE: the freezer will set the temperature cyclically adjust between -14°C and -24°C.

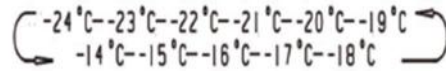

To adjust the temperature in Fahrenheit, check that the °F light is on near the temperature display. If the °C is showing, switch the display mode from °F to °C by pressing the TEMP (Hold 3s) button for 3 seconds.

Press the TEMP (Hold 3s), until you select the temperature that you want.

PLEASE NOTE: the freezer will set the temperature cyclically adjust between 7°F and -11°F.

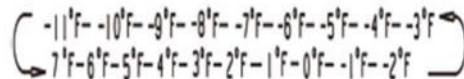

3. Quick Freeze

Quick Freeze can boost the freezing process faster.

Ensure the freezer is unlocked by checking that there is no light on ECO (Lock Hold). If the light is on, press and hold for 3 seconds.

To activate the Quick Freeze function, press the Quick Freeze button until the icon light is lit. The temperature is then set to -24°C (-11°F)

Quick Freeze mode automatically exits after about 52 hours.

To deactivate the Quick Freeze mode, press button until the light goes off and the refrigerator temperature setting will revert to the previous setting.

4. Eco Mode

If you are going to be away for a long period of time, you can turn it to Eco mode to maintain a cooling temperature but save on electricity.

Ensure the freezer is unlocked by checking that there is no light on ECO (Lock Hold). If the light is on, press and hold for 3 seconds.

To activate Eco Mode, press the button until the light is lit. The temperature is set to -17°C (1°F).

To deactivate Eco Mode, press the button until the light goes off. The freezer temperature setting will revert to the previous setting.

5. Child Lock

You can lock the controls of the refrigerator. The Child Lock is automatically turned on.

To deactivate the child lock, press and hold the button for 3 seconds until the light goes off. Now you can change the other functions of the freezer.

If no button has been pressed for 20 seconds, the light will be on.

6. Alarm

If the door has been left open for over 2 minutes, then the door alarm will sound & the control panel will show "dr". The icon will flash and there will be buzzing sound.

If the door is not closed, the buzzer will sound 3 times every 1 min.

After the door alarm time exceeds more than 10 minutes, the buzzer stops beeping, the icon is off, and the display screen shows normal.

The door alarm can also be cleared by closing the door.

To save energy, please avoid keeping the door open for a long time when using the appliance.

FEATURES OF THE FREEZER

Your appliance has the accessories as shown in the “Description of the appliance”. We recommend that you read through the below carefully before using the appliance to prevent damage to the product

1. Shelves in the Freezer Cabinet

The glass shelves in the refrigerator can be taken out to adjust their position and to be cleaned.

To remove, tilt the front of the shelf upwards and gently slide out.



To replace, hold the shelf straight with the fridge cavity, angling the shelf downward. Slide the shelf in on the shelf runner, and gently drop into place.

2. Freezer Drawer

The Freezer drawers are used store food which needs to be frozen, including meat, fish, ice cream, etc.

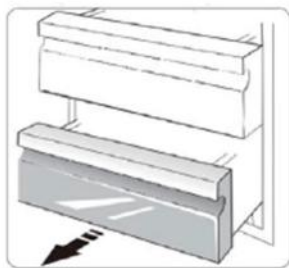

To remove, tilt the front of the drawer upwards and gently slide out.

To replace, hold the drawer straight with the fridge cavity, angling the drawer downward. Slide the drawer in on the shelf runner, and gently drop into place.

CARE AND MAINTENANCE

LED lighting



CAUTION

Your refrigerator is fitted with long life LED lighting. In the unlikely event the LED lights should fail, then the LED lights should be serviced by the manufacturer, it's service agent or similarly qualified technician. Refer to the warranty page for contact details.

If the door is left open for more than 12 minutes, the light will automatically turn off. Close and reopen the door again to turn the light back on.

Cleaning the appliance



WARNING

Before cleaning: Turn appliance off at the power point, then remove power cord from socket. This will make sure there is no chance of getting an electric shock.

- Doors - stainless steel

This stainless steel has a special advanced protective coating that eases the removal of marks such as finger prints and water spots. To keep your stainless steel appliance looking at its best, you should clean it regularly. You should only clean the stainless steel doors with luke-warm soapy water and a soft cloth, rinsing with clean water and then wipe the surface with clean water and a soft clean cloth to remove soap residue.

- Doors - cabinet & painted doors

An occasional wipe over with a clean, damp cloth will help remove finger marks. You should only clean the doors with lukewarm, soapy water and a soft cloth. Rinse with clean water and then wipe the surface with a soft, clean cloth to remove any soapy residue.

NOTE: Only wash plastic parts or decorative trim with warm (not hot) water using an unscented detergent.



CAUTION

Do not use stainless steel cleaners, abrasive pads or other cleaners as they are likely to scratch the surface. Damage to this product after delivery is not covered by your warranty.

- Interior

You should clean the appliance interior regularly. It will be easiest to clean when the food supply is low. Wash the interior with a soft cloth and use an unscented mild soap with lukewarm water. Thoroughly dry all surfaces and removable parts. Avoid getting water on appliance controls. If you have taken out any removable parts, replace them and switch the power on before re-stocking the appliance with food. Naturally, you should keep the interior of your appliance hygienic by promptly and thoroughly wiping up any food spills.

Do not use a steam cleaner. If live components come into contact with condensing steam, they may short-circuit or cause an electric shock.

- Door seals

Take care to keep door seals clean. Sticky food and drink can cause seals to stick to the cabinet and tear when you open the door. Wash seal with a mild detergent and warm water. Rinse thoroughly and dry.



CAUTION

Never use hot water, solvents, commercial kitchen cleaners, aerosol cleaners, metal polishes, caustic or abrasive cleaners, or scourers to clean this appliance, as they will damage it. Many commercially available cleaning products and detergents contain solvents that will damage your refrigerator. When cleaning, use only a soft cloth with an unscented mild soap and lukewarm water.

FOOD STORAGE TIPS

Storing food

Refrigeration reduces the rate of food spoilage. To maximise the shelf life of perishable food products, ensure that the food is of the freshest possible quality. The following is a general guide to help promote longer food storage.

Fruit and vegetables



To minimise moisture loss, fruit and vegetables should be loosely enclosed in a plastic material (e.g. wrap, bags) and placed in the Vegetable crisper or the Chilled compartment. Those fruits and vegetables with thick skins do not require wrapping.

Dairy products and eggs

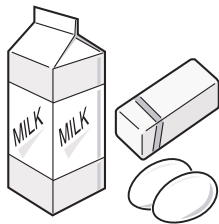

- Most dairy products have a use by date on the outer packaging which indicates the recommended temperature and expected life of the product.
- Eggs should be stored in the egg tray.

Meat, fish and poultry

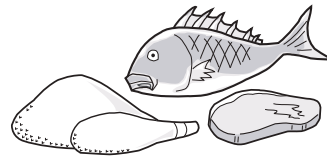

- Place on a plate or dish and cover with paper or plastic wrap.
- For larger cuts of meat, fish or poultry, place to the rear of the shelves.
- Ensure **all** cooked food is wrapped securely or placed in an airtight container.

NOTES: Evenly place the food on the shelves to allow the cooling air to circulate efficiently.

Hot foods should be cooled before storing. Storing hot foods increases the temperature in the unit and increases the risk of food spoilage.

Do not block the outlet and inlet of the cool air circulating circuit with foods or containers; otherwise the foods will not be evenly cooled throughout the refrigerator.

Do not place food directly in front of the cold air outlet. This may lead to the food freezing.

NOISES

Appliance noise

Your new refrigerator may make sounds that your old one didn't make. Because the sounds are new to you, you might be concerned about them. Most of the new sounds are normal. Hard surfaces, like the floor, walls and cabinets, can make the sounds seem louder than they actually are. The following describes the kinds of sounds and what may be making them.

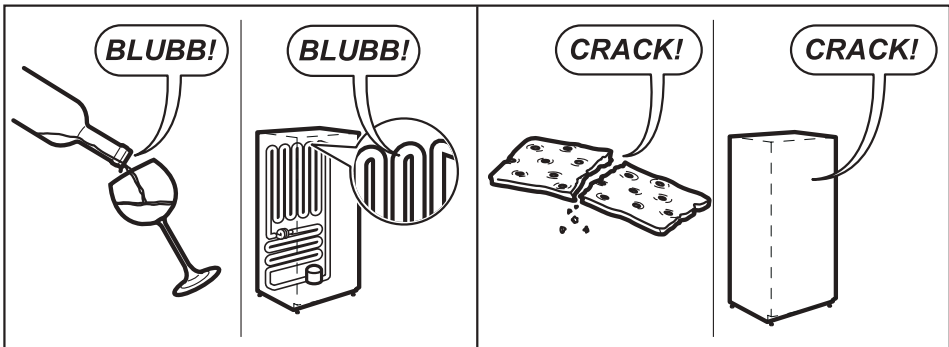
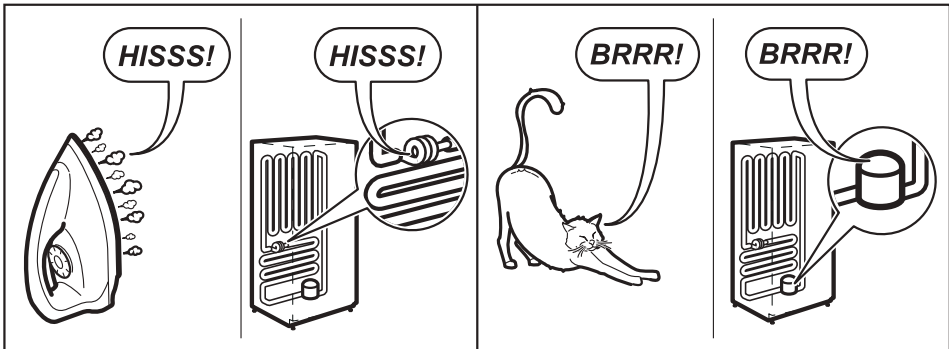
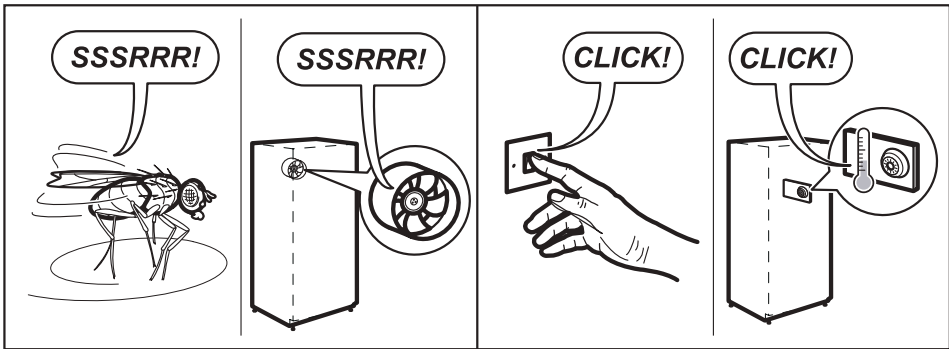
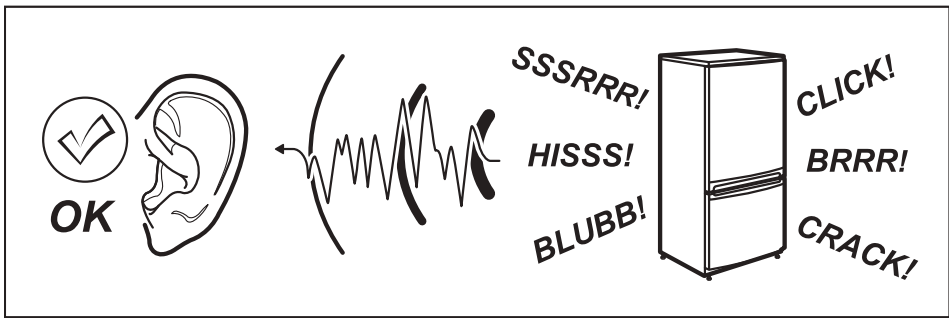

TROUBLESHOOTING

If you think something may be wrong with your refrigerator, you can carry out some easy checks before calling for service. You may locate the problem, sparing yourself from inconvenience, saving time and money.

| PROBLEM | SOLUTION |
|--|--|
| Refrigerator is not operating | <ul style="list-style-type: none"> • Check that the power cord is plugged into the power outlet properly and that the outlet is switched on. • Check that the refrigerator is switched on at the control panel. The refrigerator can be turned on by pressing and holding the On button. • Try running another appliance from the power outlet. If no power is coming from the outlet you may have blown a fuse or tripped a circuit of your household power supply. • Try adjusting the temperature control to a slightly “colder” position. |
| When there is refrigerator noise | <p>Modern refrigerators with increased storage capacity use high speed compressors. These can provide a seemingly high level of sound which is quite normal. Normal operational sounds include:</p> <ul style="list-style-type: none"> • Occasional gurgling, similar to water boiling. • Air flow noise (air circulates because of a small fan). • A clicking noise heard just before the compressor starts (this is just the automatic switching action of the temperature control, turning the compressor on or off). <p>Other strange sounds may mean that you need to check and take action. For example, noises may mean that:</p> <ul style="list-style-type: none"> • The cabinet is not level. • The floor is uneven or weak. • Bottles are badly placed and rattling. • There are vibrations from an object on top of or behind or beside the refrigerator. • The back of the refrigerator cabinet is touching the wall. <p>Remember it is quite normal for noise to seem louder when the refrigerator starts operating, or during quieter periods such as night time.</p> |
| If there are odours inside the refrigerator | <ul style="list-style-type: none"> • The interior may need cleaning. • Some foods produce odours. • Some containers and wrapping can cause odours. • Ask yourself if the odour started about the same time you started storing something unusual. |
| When the motor seems to run more than expected | <p>Your new refrigerator has a large fridge section to keep cool. So it is normal to frequently hear the sound of the motor. However, to keep operation to a minimum check the following:</p> <ul style="list-style-type: none"> • The refrigerator door is kept open too long or opened too often. • Are controls set too cold? See ‘Controlling the temperature’ on pages 11. • Have large amounts of warm food just recently been stored? Summer, festive seasons and holidays usually mean a lot more work for your refrigerator. • If the day is hot or the room is very warm, the refrigerator will need to run more than normal. • The refrigerator will run more than normal just after you install it or when it has been turned off for a long time. |

| | |
|---|---|
| If the temperature in the refrigerator is too warm | <ul style="list-style-type: none"> • Check that the appliance has enough clearance at the sides, back and top. Refer to the installation instructions on page 6. • Refer to 'Controlling the temperature' on pages 11. • You may have kept the door open too long or too frequently. • Food containers or packaging may be holding a door open. |
| If the temperature in the refrigerator is too cold | <ul style="list-style-type: none"> • Refer to 'Controlling the temperature' on page 11. • Increase the temperature to avoid high energy consumption. |
| If water drips on the floor | <ul style="list-style-type: none"> • The defrost water tray, (located at the back or underneath of the cabinet) may not be properly positioned, or the drain tube may not be properly positioned to direct water into this tray. You may need to pull the refrigerator away from the wall to check the tray and tube. |
| If the doors will not close | <ul style="list-style-type: none"> • Check whether the top of the refrigerator is tilted back 10-15mm to allow the doors to self close. • Check whether something is holding the door open. • Check bins are positioned correctly on slides after cleaning. |
| When temperature is hot/warm on the outside and rear side of the refrigerator | <ul style="list-style-type: none"> • In normal operation, the refrigerator transfers heat from inside to outside of the cabinet. • It is normal for the side and rear of the refrigerator to feel warm/hot while operating. • This will be more noticeable during start up and hot ambient conditions. |

If you still require service

If you have a problem, and the problem persists after you have made the checks mentioned above, contact your nearest Electrolux approved Service Centre or the dealer you bought the refrigerator from. Be ready to quote the model number, 9-digit PNC and 8-digit serial number, which is stated on the label inside the refrigerator compartment.



This document sets out the terms and conditions of the product warranties for Electrolux Appliances. It is an important document. Please keep it with your proof of purchase documents in a safe place for future reference should you require service for your Appliance.

1. In this warranty:
 - (a) 'acceptable quality' as referred to in clause 10 of this warranty has the same meaning referred to in the ACL;
 - (b) 'ACL' means Schedule 2 to the Competition and Consumer Act 2010;
 - (c) 'Appliance' means any Electrolux product purchased by you and accompanied by this document;
 - (d) 'ASC' means Electrolux authorised service centres;
 - (e) 'Electrolux' means Electrolux Home Products Pty Ltd of 163 O'Riordan Street, Mascot NSW 2020, ABN 51 004 762 341 in respect of Appliances purchased in Australia and Electrolux (NZ) Limited (collectively 'Electrolux') of 3-5 Niall Burgess Road, Mount Wellington, in respect of Appliances purchased in New Zealand;
 - (f) 'major failure' as referred to in clause 10 of this warranty has the same meaning referred to in the ACL and includes a situation when an Appliance cannot be repaired or it is uneconomic for Electrolux, at its discretion, to repair an Appliance during the Warranty Period;
 - (g) 'Warranty Period' means the Appliance is warranted against manufacturing defects in Australia and New Zealand for 24 months and for the Appliance's compressor, condenser, evaporator and drier, an additional 36 months parts only warranty applies, following the date of original purchase of the Appliance;
 - (h) 'you' means the purchaser of the Appliance not having purchased the Appliance for re-sale, and 'your' has a corresponding meaning.
2. This warranty only applies to Appliances purchased and used in Australia or New Zealand and used in normal domestic applications and is in addition to (and does not exclude, restrict, or modify in any way) any non-excludable statutory warranties in Australia or New Zealand.
3. During the Warranty Period Electrolux or its ASC will, at no extra charge if your Appliance is readily accessible for service, without special equipment and subject to these terms and conditions, repair or replace any parts which it considers to be defective. Electrolux or its ASC may use remanufactured parts to repair your Appliance. You agree that any replaced Appliances or parts become the property of Electrolux. This warranty does not apply to light globes, batteries, filters or similar perishable parts.
4. Parts and Appliances not supplied by Electrolux are not covered by this warranty.
5. To the extent permitted by law, you will bear the cost of transportation, travel and delivery of the Appliance to and from Electrolux or its ASC. If you reside outside of the service area, you will bear the cost of:
 - (a) travel of an authorised representative;
 - (b) transportation and delivery of the Appliance to and from Electrolux or its ASC.

In all instances, unless the Appliance is transported by Electrolux or an Electrolux authorised representative, the Appliance is transported at the owner's cost and risk while in transit to and from Electrolux or its ASC.
6. Proof of purchase is required before you can make a claim under this warranty.
7. You may not make a claim under this warranty unless the defect claimed is due to faulty or defective parts or workmanship. Electrolux is not liable in the following situations (which are not exhaustive):
 - (a) the Appliance is damaged by:
 - (i) accident
 - (ii) misuse or abuse, including failure to properly maintain or service
 - (iii) normal wear and tear
 - (iv) power surges, electrical storm damage or incorrect power supply
 - (v) incomplete or improper installation
 - (vi) incorrect, improper or inappropriate operation
 - (vii) insect or vermin infestation
 - (viii) failure to comply with any additional instructions supplied with the Appliance;
 - (b) the Appliance is modified without authority from Electrolux in writing;
 - (c) the Appliance's serial number or warranty seal has been removed or defaced;
 - (d) the Appliance was serviced or repaired by anyone other than Electrolux, an authorised repairer or ASC.
8. This warranty, the contract to which it relates and the relationship between you and Electrolux are governed by the law applicable where the Appliance was purchased. Where the Appliance was purchased in New Zealand for commercial purposes the Consumer Guarantee Act does not apply.
9. To the extent permitted by law and subject to your non-excludable statutory rights and warranties, Electrolux excludes all warranties and liabilities (other than as contained in this document) including liability for any loss or damage whether direct or indirect arising from your purchase, use or non use of the Appliance.
10. For Appliances and services provided by Electrolux in Australia, the Appliances come with a guarantee by Electrolux that cannot be excluded under the ACL. You are entitled to a replacement or refund for a major failure and for compensation for any other reasonably foreseeable loss or damage. You are also entitled to have the Appliance repaired or replaced if the Appliance fails to be of acceptable quality and the failure does not amount to a major failure. The benefits to you given by this warranty are in addition to your other rights and remedies under a law in relation to the Appliances or services to which the warranty relates.
11. At all times during the Warranty Period, Electrolux shall, at its discretion, determine whether repair, replacement or refund will apply if an Appliance has a valid warranty claim applicable to it.
12. For Appliances and services provided by Electrolux in New Zealand, the Appliances come with a guarantee by Electrolux pursuant to the provisions of the Consumer Guarantees Act, the Sale of Goods Act and the Fair Trading Act.
13. To enquire about claiming under this warranty, please follow these steps:
 - (a) carefully check the operating instructions, user manual and the terms of this warranty;
 - (b) have the model and serial number of the Appliance available;
 - (c) have the proof of purchase (e.g. an invoice) available;
 - (d) telephone the numbers shown below.
14. You accept that if you make a warranty claim, Electrolux and its ASC may exchange information in relation to you to enable Electrolux to meet its obligations under this warranty.

Important Notice

Before calling for service, please ensure that the steps listed in clause 13 above have been followed.

| | | |
|--|--|--|
| <p>FOR SERVICE or to find the address of your nearest state service centre in Australia PLEASE CALL 13 13 49 For the cost of a local call (Australia only)</p> | <p>SERVICE AUSTRALIA  Electrolux ELECTROLUX HOME PRODUCTS electrolux.com.au</p> | <p>FOR SPARE PARTS or to find the address of your nearest state spare parts centre in Australia PLEASE CALL 13 13 50 For the cost of a local call (Australia only)</p> |
| <p>FOR SERVICE or to find the address of your nearest authorised service centre in New Zealand FREE CALL 0800 10 66 10 (New Zealand only)</p> | <p>SERVICE NEW ZEALAND  Electrolux ELECTROLUX (NZ) Limited electrolux.co.nz</p> | <p>FOR SPARE PARTS or to find the address of your nearest state spare parts centre in New Zealand FREE CALL 0800 10 66 20 (New Zealand only)</p> |



Customer Care Centre

Contact us if you need more help

Australia

telephone: 13 13 49
email: customercare@electrolux.com.au
web: westinghouse.com.au

New Zealand

telephone: 0800 436 245
email: customercare@electrolux.co.nz
web: westinghouse.co.nz

 and WESTINGHOUSE are trademarks of Westinghouse Electric Corporation.
Used under license by Electrolux Home Products Pty Ltd. All Rights Reserved.

© 2021 Electrolux Home Products Pty Ltd.
ABN 51 004 762 341
W_MAN_AFRI_Nov21

4264615-C