

fridges



They say the kitchen is the heart and soul of every home.

14 Large French door

24 Slim French door

32 Compact French door

38 Large bottom mount

48 Compact bottom mount

54 Large top mount

62 Compact top mount

70 Side by sides

78 Verticals and pigeon pairs

90 Accessories

92 Integration

94 Specifications

118 Dimensions

After all, the way to everyone's heart is through their stomach. We aren't about fancy features, just beautiful designs that work, created with the freshest produce in mind. Our new Westinghouse fridge range is evolving with today's modern household, combining functionality with style. Simple design that allows your family to create and live with ease. That's why we created FlexSpace. A humble solution for your family's fridge needs, that allows you to configure the interior any way you want.

Showcasing a stylish flat door design, our range is available in dark or natural real stainless steel and white to compliment your kitchen and lifestyle. With consideration for the environment, our new models have been designed to be energy efficient, keeping your costs down and allowing you to care for your surroundings.



choose the right fridge with Westinghouse

A fridge is a vital part of every home, but with so many to choose from it can be difficult to know which one is right for your family. So, to help you find your perfect fridge, we've put together some helpful guidelines and questions to consider.

type & style

- Think about the style of your kitchen. Would white, dark, stainless steel or arctic silver suit your space?
- Do you have limited space but still want all the benefits of a large fridge in a slimmer model?
- Do you like the aesthetics of a French door model and the idea of an ice and water dispenser?
- Do you tend to have a lot of frozen food or do you need more fresh food and drinks storage?

dimensions

- Does the fridge need to fit into an existing space? Make sure you measure your kitchen cavity and doorways before choosing a fridge.
- Remember that fridges need air space around them to keep them running at their best. Check this when considering which models will fit your kitchen cavity.

capacity

- As a general rule a family of two needs around 300L of food storage space. For each additional family member add around 60L.
- Remember your family may grow in the future, so when in doubt, go for a larger size. Larger fridges tend to have more features and are more efficient.

flexible interiors

- Are storage space and flexible interiors important to you?
- Do you like to entertain or regularly need to fit a lot of food and drinks into your fridge? Our new FlexSpace™ range maximises storage, flexibility and access making it perfect for families.

value

- Consider which features are most useful to you. Your family's needs may change, so a fridge that can adapt with you is a great option.
- Ongoing running costs can eat into your family budget so check the energy rating system (the more stars and the lower kWh per year the better).

easy cleaning

- Food can be messy! So you'll benefit from SpillSafe shelves, easy-to-remove parts and fingerprint-resistant surfaces.

functions & controls

- Manual controls are quick and easy to use
- Electronic controls offer a wider range of clever functions including quick chill, door alarms, quick freeze and holiday mode.

security & reliability

- A fridge or freezer is a considerable investment so make sure you buy a quality brand you can trust.
- For extra peace-of-mind ensure that the company you choose can provide advice, service and support for your fridge well beyond the shop floor.

R600a refrigerant

- Westinghouse is committed to caring for the environment. That's why all of our fridges have started converting over to use the less harmful R600a refrigerant. So now your family fridge can quietly play its own part in reducing your household's impact on the environment.



more flex,
more space.

ORGANISATION SOLUTION

FlexSpace™

There's a good fridge then there's a great fridge. The Westinghouse FlexSpace range is definitely the latter, specifically designed for households of 1 or 10, we'll fit into your lifestyle. We know you can always do more with the space you've got. With a combination of clever adjustable interiors, our shelves, drawers, crispers and door bins have got you covered.



STYLISH DESIGN

real steel



Our fridges are available in a dark or natural real stainless steel.* Creating a stylish new centrepiece in your kitchen that is easy to clean with a fingerprint resistant finish.

* Selected models.



FRESHSEAL CRISPERS

superior seals, superior flavour

Whether you're cooking for the family or just yourself, freshness is the king of the kitchen. Our FreshSeal Crispers have advanced seals, and with humidity control you get better flexibility to look after your food the right way. Our seals assist in preventing moisture loss, while the humidity control lets you provide a better environment for fresher tasting food.

the kitchen
is the heart
and soul of
every home



LARGE FRENCH DOOR

larger than life

Our large French door range can accommodate the ever-growing family and the appetites that come with it. With dual doors opening to reveal a cavernous interior, our large French door fridge with convertible compartment or drawer and FlexSpace has room for the whole family's hungry tummies.





LARGE FRENCH DOOR

features

Flexspace™ fully convertible drawer

With the widest temperature range from -23C to +7C, our FlexSpace™ Fully Convertible Drawer adapts to your needs with the touch of a button*. With 5 predefined settings you can chill your drinks, freeze your meat or store your deli snacks, taking the headache out of the fridge and freezer shuffle, making you feel really clever.

Dual freezer storage

With extra freezer space, you can arrange your frozen items in a way that suits your lifestyle. Place the most important items like ice cream in the top drawer and prepared meals when mum's away in the bottom drawer

Freshseal™ easy glide crispers

The FreshSeal™ crispers with automatic humidity control give you the flexibility to look after your fruit and vegetables the right way. Designed with your comfort in mind, the easy glide crispers bins open effortlessly and provide easy access even when they're full.

smartsplit door design

Our SmartSplit™ optimally split doors, are not only stylish but help you use the space in your fridge more efficiently. Store larger items on one side, smaller ones on the other and eliminate the need to open both doors every time.

filtered ice & water dispenser

The built in door dispenser provides fresh, filtered water as well as cubed or crushed ice at the touch of a button.

slide back and flip up shelves

The flexibility to slide back or flip up some of the fridge shelving makes fitting those extra tall items or large platters a piece of cake

SnackZone

The SnackZone is the ideal compartment for family favourites. The optimal height for even the smallest family members to reach, ensuring healthy snacks are always available

dualcooling

With the DualCooling system, the fridge and freezer compartments work independently to maintain the optimum temperature and humidity to keep foods fresh or frozen



*within 2 hours
^ WQE6870SA & WQE6870BA only
† WHE6170BB & WHE6170SB only

RANGE
large French door



WQE6870BA

609L french door refrigerator, dark stainless steel with convertible compartment

- Convertible temperature compartment that converts from fridge to freezer
- Asymmetrical door design for more usable door storage
- Easy glide crispers with automatic humidity control
- Filtered ice and water dispenser
- Slide Back and Flip Up shelves



Overall Fridge dimensions* (including door):
 1782h x 913w x 749d (mm)

Door is designed to sit proud



WQE6870SA

609L french door refrigerator, stainless steel with convertible compartment

- Convertible temperature compartment that converts from fridge to freezer
- Asymmetrical door design for more usable door storage
- Easy glide crispers with automatic humidity control
- Filtered ice and water dispenser
- Slide Back and Flip Up shelves



Overall Fridge dimensions* (including door):
 1828h x 913w x 749d (mm)

Door is designed to sit proud



chill as you choose with the FlexSpace compartment



RANGE
large French door



WHE6170BB/WHE6170SB

609L stainless steel french door fridge with drawer

- Convertible temperature compartment that converts from fridge to freezer
- Asymmetrical door design for more usable door storage
- FreshSeal™ Easy Glide Humidity Controlled Crispers
- Filtered ice and water dispenser
- Flip up Shelf



Overall Fridge dimensions* (including door):
 1782h x 913w x 813d (mm)

Door is designed to sit proud



WHE6270SB

619L stainless steel french door fridge with drawer

- Large 248L freezer capacity split between two easy access drawers
- Asymmetrical door design for more usable door storage
- FreshSeal™ Easy Glide Humidity Controlled Crispers
- Filtered ice and water dispenser
- Slide Back and Flip Up shelves



Overall Fridge dimensions* (including door):
 1782h x 913w x 813d (mm)

Door is designed to sit proud





SLIM FRENCH DOOR

Slim in size, packed with features

Our range of fridges pack a lot into their slim French doors. Designed to fit into a 90cm fridge cavity, these fridges come with far more space than meets the eye. This means more fresh food, big grocery shops and a fridge that is always organised. You'll never run low on space, or compartments. With three or four door configurations you can stack like a pro, fitting more of your favourite produce in the fridge you love.

WQE6060BB



SLIM FRENCH DOOR

features

slim fridge, to fit in a 90cm space

Designed for maximum storage, our large 600/605L Westinghouse French door fridges are slim enough to fit in a 90cm space with ease.

contains spills

Spills happen, but when they do, the world doesn't have to end. The Westinghouse Spillsafe glass shelves help with the mess by containing the spilt liquid to one shelf, so you have less to clean.

filtered water

Designed to quench the needs of even the thirstiest family member, the filtered water dispenser built into the fridge door will eliminate thirst in your household with refreshing convenience. (Selected models)

always on ice

With the convenience of an automatic ice maker, we've got your ice needs covered. By continuously replenishing itself, you will always have ice available for your family or last minute guests. (Selected models)

superior seals, superior flavour

Our FreshSeal Crispers have advanced seals, and with humidity control you get better flexibility to look after your food the right way. Our seals assist in preventing moisture loss, while the humidity control lets you provide a better environment for fresher tasting food.

never fear, our family safe lock is here

Some things picked up on the shop aren't meant to be shared. Keep medication or treats from prying hands with the Westinghouse FamilySafe Lockable Compartment.

endless possibilities with FlexSpace™

Designed to suit your ever-changing needs, the extra spacious French door design delivers a wider fridge capacity with FlexSpace™. Perfect for party platters or lots of fresh food, you'll love having everything at eye level so you can easily check all the contents with just a glance.

keeping your fridge looking its spotless best

Life can get messy, that's why we've made our Westinghouse fingerprint resistant real stainless steel easy to clean. Just one quick wipe with a damp cloth and you are mark free again.

RANGE
slim French door



WQE6060BB

541L french quad door refrigerator, dark stainless steel with in door ice & water dispenser

- Fits into a 900mm space
- Continuous fresh water & ice maker
- Dual sealed crispers with humidity control
- Adjustable storage solutions
- SpillSafe™ glass shelves



Overall Fridge dimensions* (including door):
 1725h x 896w x 781d (mm)
 Door is designed to sit proud



WQE6000BB

541L french door refrigerator, dark stainless steel

- Fits into a 900mm space
- Dual sealed crispers with humidity control
- Adjustable storage solutions
- SpillSafe™ glass shelves
- Lockable compartment



Overall Fridge dimensions* (including door):
 1725h x 896w x 781d (mm)
 Door is designed to sit proud



WQE6060SB

541L french quad door refrigerator, natural stainless steel with in door ice & water dispenser

- Fits into a 900mm space
- Continuous fresh water & ice maker
- Dual sealed crispers with humidity control
- Adjustable storage solutions
- SpillSafe™ glass shelves



Overall Fridge dimensions* (including door):
 1725h x 896w x 781d (mm)
 Door is designed to sit proud



WQE6000SB

541L french door refrigerator, natural stainless steel

- Fits into a 900mm space
- Dual sealed crispers with humidity control
- Adjustable storage solutions
- SpillSafe™ glass shelves
- Lockable compartment



Overall Fridge dimensions* (including door):
 1725h x 896w x 781d (mm)
 Door is designed to sit proud

RANGE
slim French door



WHE6060SB

565L french door refrigerator, natural stainless steel with drawer & in door water dispenser

- Fits into a 900mm space
- Dual sealed crispers with humidity control
- Continuous fresh water & ice maker
- Adjustable storage solutions
- SpillSafe™ glass shelves



Overall Fridge dimensions* (including door):
 1725h x 896w x 781d (mm)

Door is designed to sit proud



WHE6000SB

565L french door refrigerator, natural stainless steel with drawer

- Fits into a 900mm space
- Dual sealed crispers with humidity control
- Adjustable storage solutions
- SpillSafe™ glass shelves
- Lockable compartment



Overall Fridge dimensions* (including door):
 1725h x 896w x 781d (mm)

Door is designed to sit proud



WHE6060SA



COMPACT FRENCH DOOR

compact, yet stylish

Loaded with timeless style, our range of compact French door fridges come with flexible interiors giving you more time to create the tasty and nutritious meals for those you love. Available in dark and natural fingerprint-resistant real stainless steel, it's a fridge that's life proof and looks at home in your kitchen.

WHE5204BC



COMPACT FRENCH DOOR

features

stylish design

Crafted with ultra-modern flat doors, elegant handle options and your choice of Dark or Natural Real Stainless Steel your fridge will be the centrepiece of your kitchen. (Options vary by model)

less energy, more care

Our range has been designed to be energy efficient*, reducing your electricity usage and so helping you to care for the environment around you. (Energy ratings and running costs vary by model)

*Designed to meet AS/NZS IEC 62552-3 (L)

superior seals, superior flavour

Our FreshSeal Crispers have advanced seals, and with humidity control you get better flexibility to look after your food the right way. Our seals assist in preventing moisture loss, while the humidity control lets you provide a better environment for fresher tasting food.

FlexStor fits your life

When life gets busy, flexibility is a life saver. That's why Westinghouse created the FlexStor system. The adjustable door bins allow for quick and easy adjustment whenever or however you need it. We make it easy to do more with your fridge.

contains spills

Spills happen, but when they do, the world doesn't have to end. The Westinghouse Spillsafe glass shelves help with the mess by containing the spill liquid to one shelf, so you have less to clean.

always on ice

With the convenience of an automatic ice maker, we've got your ice needs covered. By continuously replenishing itself, you will always have ice available for your family or last minute guests. (Selected models)

easy glide runners

You don't know it yet but you'll love our easy glide telescopic runners. They're easy to open and close and when fully extended provide superior access to your frozen foods. No matter how much food you have stored, they'll always run smoothly.

keeping your fridge looking its spotless best

Life can get messy, that's why we've made our Westinghouse fingerprint resistant real stainless steel easy to clean. Just one quick wipe with a damp cloth and you are mark free again.



RANGE
compact French door



WHE5204BC

491L french door refrigerator, dark stainless steel with drawer

- Stylish flat door design
- Excellent energy efficiency with inverter compressor
- Sealed crisper with humidity control
- Adjustable storage solutions
- SpillSafe™ glass shelves



Overall Fridge dimensions* (including door):
1725h x 796w x 769d (mm)
Door is designed to sit proud



WHE5204SC

491L french door refrigerator, natural stainless steel with drawer

- Stylish flat door design
- Excellent energy efficiency with inverter compressor
- Sealed crisper with humidity control
- Adjustable storage solutions
- SpillSafe™ glass shelves



Overall Fridge dimensions* (including door):
1725h x 796w x 769d (mm)
Door is designed to sit proud



WHE5264SC

491L french door refrigerator, natural stainless steel with freezer drawer & in door water dispenser

- Stylish flat door design
- Excellent energy efficiency with inverter compressor
- Continuous fresh water & ice maker
- Sealed crisper with humidity control
- Adjustable storage solutions



Overall Fridge dimensions* (including door):
1725h x 796w x 769d (mm)
Door is designed to sit proud

LARGE BOTTOM MOUNT

packed with flexible features

Whether it's parties, or a cheeky lunch leftover, we have flexible space for everything, combined with a humidity controlled FreshSeal Crisper for longer lasting produce. The freezer, conveniently placed at the bottom, features telescopic runners in the drawers, creating easier access even when full.

WBE4504SC





LARGE BOTTOM MOUNT

features

keep it stylish

Crafted with ultra-modern flat doors, elegant handle options and your choice of Dark or Natural Real Stainless Steel or white your fridge will be the centrepiece of your kitchen. (Options vary by model)

contains spills

Spills happen, but when they do, the world doesn't have to end. The Westinghouse Spillsafe glass shelves help with the mess by containing the spilt liquid to one shelf, so you have less to clean.

less energy, more care

Our range has been designed to be energy efficient*, reducing your electricity usage and so helping you to care for the environment around you. (Energy ratings and running costs vary by model)

*Designed to meet AS/NZS IEC 62552-3 (L)

cool down with a twist

Whether it's for an afternoon juice or a whisky on the "rocks", our easy access twist ice dispenser and tray allows you to just twist and serve ice simply.

superior seals, superior flavour

Our FreshSeal Crispers have advanced seals, and with humidity control you get better flexibility to look after your food the right way. Our seals assist in preventing moisture loss, while the humidity control lets you provide a better environment for fresher tasting food.

easy glide runners

You don't know it yet but you'll love our easy glide telescopic runners. They're easy to open and close and when fully extended provide superior access to your frozen foods. No matter how much food you have stored, they'll always run smoothly.

keeping your fridge looking its spotless best

Life can get messy, that's why we've made our Westinghouse fingerprint resistant real stainless steel easy to clean. Just one quick wipe with a damp cloth and you are mark free again.

FlexStor fits your life

When life gets busy, flexibility is a life saver. That's why Westinghouse created the FlexStor system. The adjustable door bins allow for quick and easy adjustment whenever or however you need it. We make it easy to do more with your fridge.

RANGE
large bottom mount



WBE4504BC

425L bottom freezer refrigerator, dark stainless steel with pole handles

- Stylish flat door design
- Excellent energy efficiency with inverter compressor
- Sealed crisper with humidity control
- Adjustable storage solutions
- SpillSafe™ glass shelves
- Easy glide telescopic freezer drawers



Overall Fridge dimensions* (including door):
 1725h x 699w x 769d (mm)

Door is designed to sit proud



WBE4500BC

425L bottom freezer refrigerator, dark stainless steel

- Stylish flat door design
- Excellent energy efficiency with inverter compressor
- Sealed crisper with humidity control
- Adjustable storage solutions
- SpillSafe™ glass shelves
- Easy glide telescopic freezer drawers



Overall Fridge dimensions* (including door):
 1725h x 699w x 723d (mm)

Door is designed to sit proud



WBE4504SC

425L bottom freezer refrigerator, natural stainless steel with pole handles

- Stylish flat door design
- Excellent energy efficiency with inverter compressor
- Sealed crisper with humidity control
- Adjustable storage solutions
- SpillSafe™ glass shelves
- Easy glide telescopic freezer drawers



Overall Fridge dimensions* (including door):
 1725h x 699w x 769d (mm)

Door is designed to sit proud



WBE4500SC

425L bottom freezer refrigerator, natural stainless steel

- Stylish flat door design
- Excellent energy efficiency with inverter compressor
- Sealed crisper with humidity control
- Adjustable storage solutions
- SpillSafe™ glass shelves
- Easy glide telescopic freezer drawers



Overall Fridge dimensions* (including door):
 1725h x 699w x 723d (mm)

Door is designed to sit proud

RANGE
large bottom mount



WBE4500WC

425L bottom freezer refrigerator, white

- Stylish flat door design
- Excellent energy efficiency with inverter compressor
- Sealed crisper with humidity control
- Adjustable storage solutions
- SpillSafe™ glass shelves
- Easy glide telescopic freezer drawers



Overall Fridge dimensions* (including door):
 1725h x 699w x 723d (mm)

Door is designed to sit proud



WBE5304BC

496L bottom freezer refrigerator, dark stainless steel with pole handles

- Stylish flat door design
- Excellent energy efficiency with inverter compressor
- Sealed crisper with humidity control
- Adjustable storage solutions
- SpillSafe™ glass shelves
- Easy glide telescopic freezer drawers



Overall Fridge dimensions* (including door):
 1725h x 796w x 769d (mm)

Door is designed to sit proud



WBE5304SC

496L bottom freezer refrigerator, natural stainless steel with pole handles

- Stylish flat door design
- Excellent energy efficiency with inverter compressor
- Sealed crisper with humidity control
- Adjustable storage solutions
- SpillSafe™ glass shelves
- Easy glide telescopic freezer drawers



Overall Fridge dimensions* (including door):
 1725h x 796w x 769d (mm)

Door is designed to sit proud

RANGE
large bottom mount



WBE5300BC

496L bottom freezer refrigerator, dark stainless steel

- Stylish flat door design
- Excellent energy efficiency with inverter compressor
- Sealed crisper with humidity control
- Adjustable storage solutions
- SpillSafe™ glass shelves
- Easy glide telescopic freezer drawers



Overall Fridge dimensions* (including door):
 1725h x 796w x 723d (mm)

Door is designed to sit proud



WBE5300WC

496L bottom freezer refrigerator, white

- Stylish flat door design
- Excellent energy efficiency with inverter compressor
- Sealed crisper with humidity control
- Adjustable storage solutions
- SpillSafe™ glass shelves
- Easy glide telescopic freezer drawers



Overall Fridge dimensions* (including door):
 1725h x 796w x 723d (mm)

Door is designed to sit proud



WBE5300SC

496L bottom freezer refrigerator, natural stainless steel

- Stylish flat door design
- Excellent energy efficiency with inverter compressor
- Sealed crisper with humidity control
- Adjustable storage solutions
- SpillSafe™ glass shelves
- Easy glide telescopic freezer drawers



Overall Fridge dimensions* (including door):
 1725h x 796w x 723d (mm)

Door is designed to sit proud



COMPACT BOTTOM MOUNT

fit in more of what you love

Compact doesn't always mean sacrificing features or functionality. The Westinghouse Compact Bottom Mount Fridge has the perfect flexibility for your party shop, or your weekly one, fitting in what you need when you need and keeping it fresh.

WBB3700AH



COMPACT BOTTOM MOUNT

features

humidity controlled crisper

The full width, humidity controlled crisper offers the perfect environment for preserving fruit and vegetables, as well as having a removable crisper front for easy cleaning.

keep your food fresher for longer

Fresher food means tastier food. The Westinghouse Multi-Flow Air Delivery System keeps the temperature stable so every ingredient in the fridge stays fresher for longer.

FlexStor fits your life

When life gets busy, flexibility is a life saver. That's why Westinghouse created the FlexStor system. The adjustable door bins allow for quick and easy adjustment whenever or however you need it. We make it easy to do more with your fridge.

easy to use electronic controls

With the Westinghouse Electronic control system, you can easily change the temperature of your fridge with the touch of a button.

easy clean glass

Cleaning your fridge shelves has never been easier. The Westinghouse adjustable glass shelving can be easily manoeuvred allowing you to effortlessly get into every nook and cranny, no matter the mess.

cool down with a twist

Whether it's for an afternoon juice or a whisky on the "rocks", our easy access twist ice dispenser and tray allows you to just twist and serve ice simply.

easy clean silver doors

The easy clean silver doors ensure our fridges maintain that sleek clean look. In fact, a damp cloth should be all you need to remove fingerprint marks.

see more with LED

Spend less time with your head in the fridge and more time enjoying your fresh food with Westinghouse's LED lighting. More light means you find what you're looking for faster.



RANGE
compact bottom mount



WBB3700AH

346L bottom freezer refrigerator, arctic steel with FlexStor

- Arctic silver finish
- Adjustable storage solutions with FlexStor™
- Humidity controlled crisper
- Twist ice & serve
- Easy clean glass shelves
- Chiller compartment



Overall Fridge dimensions* (including door):
1755h x 598w x 650d (mm)

Door is designed to sit proud



WBB3400AH

317L bottom freezer refrigerator, arctic steel with FlexStor

- Arctic silver finish
- Adjustable storage solutions with FlexStor™
- Humidity controlled crisper
- Twist ice & serve
- Easy clean glass shelves
- Chiller compartment



Overall Fridge dimensions* (including door):
1645h x 598w x 650d (mm)

Door is designed to sit proud



WBB3700WH

346L bottom freezer refrigerator, white with FlexStor

- Adjustable storage solutions with FlexStor™
- Humidity controlled crisper
- Twist ice & serve
- Easy clean glass shelves
- Chiller compartment



Overall Fridge dimensions* (including door):
1755h x 598w x 650d (mm)

Door is designed to sit proud



WBB3400WH

317L bottom freezer refrigerator, white with FlexStor

- Adjustable storage solutions with FlexStor™
- Humidity controlled crisper
- Twist ice & serve
- Easy clean glass shelves
- Chiller compartment



Overall Fridge dimensions* (including door):
1645h x 598w x 650d (mm)

Door is designed to sit proud

LARGE TOP MOUNT

more space for fresh food

The best fridges should have plenty of space for fresh food. Our popular range of Large Top Mount Fridges are designed for exactly that. Featuring FlexSpace interiors which lets you rearrange the height and the positions of your door bins and shelves to suit your ever changing needs.

WTB5400SC





LARGE TOP MOUNT

features

keep it stylish

Crafted with ultra-modern flat doors, elegant handle options and your choice of Dark or Natural Real Stainless Steel or white your fridge will be the centrepiece of your kitchen. (Options vary by model)

contains spills

Spills happen, but when they do, the world doesn't have to end. The Westinghouse Spillsafe glass shelves help with the mess by containing the spilt liquid to one shelf, so you have less to clean.

less energy, more care

Our range has been designed to be energy efficient*, reducing your electricity usage and so helping you to care for the environment around you. (Energy ratings and running costs vary by model)

*Designed to meet AS/NZS IEC 62552-3 (L)

cool down with a twist

Whether it's for an afternoon juice or a whisky on the "rocks", our easy access twist ice dispenser and tray allows you to just twist and serve ice simply.

superior seals, superior flavour

Our FreshSeal Crispers have advanced seals, and with humidity control you get better flexibility to look after your food the right way. Our seals assist in preventing moisture loss, while the humidity control lets you provide a better environment for fresher tasting food.

chilled and organised

Bring the whole deli home with our large organised chiller compartments. Easy to find what you need when you need them so you spend more time creating and less time playing deli detective.

keeping your fridge looking its spotless best

Life can get messy, that's why we've made our Westinghouse fingerprint resistant real stainless steel easy to clean. Just one quick wipe with a damp cloth and you are mark free again.

FlexStor fits your life

When life gets busy, flexibility is a life saver. That's why Westinghouse created the FlexStor system. The adjustable door bins allow for quick and easy adjustment whenever or however you need it. We make it easy to do more with your fridge.

RANGE
large top mount



WTB4600SC

431L top freezer refrigerator, natural stainless steel with FlexStor

- Stylish flat door design
- Excellent energy efficiency with inverter compressor
- Sealed crisper with humidity control
- Adjustable storage solutions
- SpillSafe™ glass shelves



Overall Fridge dimensions* (including door):
 1725h x 699w x 723d (mm)

Door is designed to sit proud



WTB4604SC

431L top freezer refrigerator, natural stainless steel with FlexStor & pole handles

- Stylish flat door design
- Excellent energy efficiency with inverter compressor
- Sealed crisper with humidity control
- Adjustable storage solutions
- SpillSafe™ glass shelves



Overall Fridge dimensions* (including door):
 1725h x 699w x 769d (mm)

Door is designed to sit proud



WTB4600WC

431L top freezer refrigerator, white with FlexStor

- Stylish flat door design
- Excellent energy efficiency with inverter compressor
- Sealed crisper with humidity control
- Adjustable storage solutions
- SpillSafe™ glass shelves
- Lockable compartment



Overall Fridge dimensions* (including door):
 1725h x 699w x 723d (mm)

Door is designed to sit proud

RANGE
large top mount



WTB5400SC

503L top freezer refrigerator, natural stainless steel with FlexStor

- Stylish flat door design
- Excellent energy efficiency with inverter compressor
- Sealed crisper with humidity control
- Adjustable storage solutions
- SpillSafe™ glass shelves



Overall Fridge dimensions* (including door):
 1725h x 796w x 723d (mm)

Door is designed to sit proud



WTB5404SC

503L top freezer refrigerator, natural stainless steel with FlexStor & pole handles

- Stylish flat door design
- Excellent energy efficiency with inverter compressor
- Sealed crisper with humidity control
- Adjustable storage solutions
- SpillSafe™ glass shelves



Overall Fridge dimensions* (including door):
 1725h x 796w x 769d (mm)

Door is designed to sit proud



WTB5400WC

503L top freezer refrigerator, white with FlexStor

- Stylish flat door design
- Excellent energy efficiency with inverter compressor
- Sealed crisper with humidity control
- Adjustable storage solutions
- SpillSafe™ glass shelves
- Lockable compartment



Overall Fridge dimensions* (including door):
 1725h x 796w x 723d (mm)

Door is designed to sit proud



COMPACT TOP MOUNT

compact outside, big inside

Sometimes your fridge needs to be clever, compact and stylish but this doesn't mean it can't fit a lot in. At Westinghouse, we've done a great deal with small spaces, creating flexible features which maximise the effectiveness of the available space.

WTB2800AH



COMPACT TOP MOUNT

features

humidity controlled crisper

The full width, humidity controlled crisper offers the perfect environment for preserving fruit and vegetables, as well as having a removable crisper front for easy cleaning.

easy clean glass

Cleaning your fridge shelves has never been easier. The Westinghouse adjustable glass shelving can be easily manoeuvred allowing you to effortlessly get into every nook and cranny, no matter the mess.

FlexStor fits your life

When life gets busy, flexibility is a life saver. That's why Westinghouse created the FlexStor system. The adjustable door bins allow for quick and easy adjustment whenever or however you need it. We make it easy to do more with your fridge.

keep your food fresher for longer

Fresher food means tastier food. The Westinghouse Multi-Flow Air Delivery System keeps the temperature stable so every ingredient in the fridge stays fresher for longer.

chilled and organised

Bring the whole deli home with our large organised chiller compartments. Easy to find what you need when you need them so you spend more time creating and less time playing deli detective.

easy to use electronic controls

With the Westinghouse Electronic control system, you can easily change the temperature of your fridge with the touch of a button.

easy clean silver doors

The easy clean silver doors ensure our fridges maintain that sleek clean look. In fact, a damp cloth should be all you need to remove fingerprint marks.

cool down with a twist

Whether it's for an afternoon juice or a whisky on the "rocks", our easy access twist ice dispenser and tray allows you to just twist and serve ice simply.



RANGE
compact top mount



WTB3700AH

350L top freezer refrigerator, arctic steel with FlexStor

- Arctic silver finish
- Adjustable storage solutions with FlexStor™
- Humidity controlled crisper
- Twist ice & serve
- Easy clean glass shelves
- Chiller compartment



Overall Fridge dimensions* (including door):
1755h x 598w x 650d (mm)

Door is designed to sit proud



WTB3400AH

320L bottom freezer refrigerator, arctic steel with FlexStor

- Arctic silver finish
- Adjustable storage solutions with FlexStor™
- Humidity controlled crisper
- Twist ice & serve
- Easy clean glass shelves
- Chiller compartment



Overall Fridge dimensions* (including door):
1645h x 598w x 650d (mm)

Door is designed to sit proud



WTB3700WH

350L top freezer refrigerator, white with FlexStor

- Adjustable storage solutions with FlexStor™
- Humidity controlled crisper
- Twist ice & serve
- Easy clean glass shelves
- Chiller compartment



Overall Fridge dimensions* (including door):
1755h x 598w x 650d (mm)

Door is designed to sit proud



WTB3400WH

320L bottom freezer refrigerator, white with FlexStor

- Adjustable storage solutions with FlexStor™
- Humidity controlled crisper
- Twist ice & serve
- Easy clean glass shelves
- Chiller compartment



Overall Fridge dimensions* (including door):
1645h x 598w x 650d (mm)

Door is designed to sit proud

RANGE
compact top mount



WTB2800AH

256L top freezer refrigerator, arctic steel with FlexStor

- Adjustable storage solutions with FlexStor™
- Humidity controlled crisper
- Twist ice & serve
- Easy clean glass shelves
- Chiller compartment



Overall Fridge dimensions* (including door):
1605h x 540w x 615d (mm)

Door is designed to sit proud



WTB2500WH

225L top freezer refrigerator, white with FlexStor

- Adjustable storage solutions with FlexStor™
- Easy clean glass shelves
- Humidity controlled crisper
- Twist ice and serve
- Chiller compartment



Overall Fridge dimensions* (including door):
1470h x 540w x 615d (mm)

Door is designed to sit proud



WTB2800WH

256L top freezer refrigerator, white with FlexStor

- Adjustable storage solutions with FlexStor™
- Humidity controlled crisper
- Twist ice & serve
- Easy clean glass shelves
- Chiller compartment



Overall Fridge dimensions* (including door):
1605h x 540w x 615d (mm)

Door is designed to sit proud



WTB2300WH

211L top freezer refrigerator, white with FlexStor

- Adjustable storage solutions with FlexStor™
- Easy clean glass shelves
- Humidity controlled crisper
- Twist ice and serve
- Chiller compartment



Overall Fridge dimensions* (including door):
1405h x 540w x 615d (mm)

Door is designed to sit proud

SIDE BY SIDES

fridge and freezer side by side

With the convenience of a full height fridge and freezer in a single unit, our side by sides offer large capacity with ease of access. With the combination of shelves, drawers and door bins on both sides you can take your organisation skills to the next level.

WSE6870SA





SIDE BY SIDES

features

ice & water at your fingertips

An ice cold drink or fresh filter water on a warm day is one of life's greatest joys. With automatic ice and water dispenser, you and your family can have the best of both worlds for those scorching summer days. (Selected models)

never fear, our family safe lock is here

Some things picked up on the shop aren't meant to be shared. Keep medication or treats from prying hands with the Westinghouse FamilySafe Lockable Compartment.

get organised with the FlexFresh™ crisper

The sealed FlexFresh™ Crisper provides great flexibility with an adjustable divider for all the space you need.

cool down with a twist

Whether it's for an afternoon juice or a whisky on the "rocks", our easy access twist ice dispenser and tray allows you to just twist and serve ice simply. (Selected models)

FlexStor fits your life

When life gets busy, flexibility is a life saver. That's why Westinghouse created the FlexStor system. The adjustable door bins allow for quick and easy adjustment whenever or however you need it. We make it easy to do more with your fridge.

see more with LED

Spend less time with your head in the fridge and more time enjoying your fresh food with Westinghouse's LED lighting. More light means you find what you're looking for faster. Selected models.

adjustable interiors with SpillSafe glass shelves

With over 20 different shelving and door bin positions, you can easily fit the smallest deli items to the biggest party platters. SpillSafe glass shelves improve visibility and isolate leaks - preventing up to 1 litre of spills from dripping down to the shelves below.

keeping your fridge looking its spotless best

Life can get messy, that's why we've made our Westinghouse fingerprint resistant real stainless steel easy to clean. Just one quick wipe with a damp cloth and you are mark free again. (Selected models)

RANGE
large side by side



WSE6870SA

585L side by side refrigerator, stainless steel with ice & water dispenser

- Fingerprint resistant stainless steel
- Ice & water dispenser
- Adjustable storage solutions with FlexStor™
- FlexFresh™ humidity controlled crisper
- Fold away bottle rack
- SpillSafe™ glass shelves



Overall Fridge dimensions* (including door):
 1787h x 1000w x 784d (mm)

Door is designed to sit proud



WSE6900WA

612L side by side refrigerator, white

- Adjustable storage solutions with FlexStor™
- FlexFresh™ humidity controlled crisper
- Triple twist ice maker
- SpillSafe™ glass shelves
- LED lighting



Overall Fridge dimensions* (including door):
 1787h x 1000w x 784d (mm)

Door is designed to sit proud



WSE6900SA

612L side by side refrigerator, stainless steel

- Fingerprint resistant stainless steel
- Adjustable storage solutions with FlexStor™
- FlexFresh™ humidity controlled crisper
- Fold away bottle rack
- Triple twist ice maker
- SpillSafe™ glass shelves



Overall Fridge dimensions* (including door):
 1787h x 1000w x 784d (mm)

Door is designed to sit proud

RANGE
compact side by side



WSE6170SA

515L side by side refrigerator, stainless steel with ice & water dispenser

- Fingerprint resistant stainless steel
- Ice & water dispenser
- Adjustable storage solutions with FlexStor™
- FlexFresh™ humidity controlled crisper
- Fold away bottle rack
- SpillSafe™ glass shelves



Overall Fridge dimensions* (including door):
1787h x 912w x 784d (mm)

Door is designed to sit proud



WSE6200WA

542L side by side refrigerator, white

- Adjustable storage solutions with FlexStor™
- FlexFresh™ humidity controlled crisper
- Triple twist ice maker
- SpillSafe™ glass shelves
- LED lighting



Overall Fridge dimensions* (including door):
1787h x 912w x 784d (mm)

Door is designed to sit proud



WSE6200SA

542L side by side refrigerator, stainless steel

- Fingerprint resistant stainless steel
- Adjustable storage solutions with FlexStor™
- FlexFresh™ humidity controlled crisper
- Fold away bottle rack
- Triple twist ice maker
- SpillSafe™ glass shelves



Overall Fridge dimensions* (including door):
1787h x 912w x 784d (mm)

Door is designed to sit proud



SINGLE DOOR FRIDGES
AND VERTICAL FREEZERS

double the convenience

Westinghouse's single door fridges and vertical freezers can be combined to give you two units in one big space, providing you with maximum fresh food and freezer storage. Or they can be placed in separate places to give you the best utilisation of space in your kitchen.

WRB5004SC



SINGLE DOOR FRIDGES AND VERTICAL FREEZERS

features



keep it stylish

Crafted with ultra-modern flat doors, elegant handles and your choice of real stainless steel or white, your fridge will be the centrepiece of your kitchen. (Selected models)

less energy, more care

Our range has been designed to be energy efficient*, reducing your electricity usage and so helping you to care for the environment around you. (Energy ratings and running costs vary by model)

*Designed to meet AS/NZS IEC 62552-3 (L)

contains spills

Spills happen, but when they do, the world doesn't have to end. The Westinghouse Spillsafe glass shelves help with the mess by containing the spilt liquid to one shelf, so you have less to clean.

FlexStor fits your life

When life gets busy, flexibility is a life saver. That's why Westinghouse created the FlexStor system. The adjustable door bins allow for quick and easy adjustment whenever or however you need it. We make it easy to do more with your fridge.

pigeon pair

Place your single door fridge and vertical freezer together in one space to create the maximum fresh storage for your big family.

cool down with a twist

Whether it's for an afternoon juice or a whisky on the "rocks", our easy access twist ice dispenser and tray allows you to just twist and serve ice simply.

see more with LED

Spend less time with your head in the fridge and more time enjoying your fresh food with Westinghouse's LED lighting. More light means you find what you're looking for faster.

keeping your fridge looking its spotless best

Life can get messy, that's why we've made our Westinghouse fingerprint resistant real stainless steel easy to clean. Just one quick wipe with a damp cloth and you are mark free again. (Selected models)



RANGE
single door fridges



WRB5004SC

466L single door refrigerator, natural stainless steel with FlexStor™

- Stylish flat door design
- Excellent energy efficiency with inverter compressor
- Sealed crisper with humidity control
- Adjustable storage solutions SpillSafe™ glass shelves
- Fingerprint resistant real stainless steel



Overall Fridge dimensions* (including door):
1725h x 699w x 769d (mm)

Door is designed to sit proud



WRB3504SA

328L single door refrigerator, natural stainless steel with FlexStor

- Fingerprint resistant stainless steel
- Adjustable storage solutions with FlexStor™
- Combine with WFB2804SA for a pigeon pair
- SpillSafe™ glass shelves
- Quick chill function



Overall Fridge dimensions* (including door):
1746h x 595w x 700d (mm)

Door is designed to sit proud



WRB5004WC

466L single door refrigerator, white with FlexStor™

- Stylish flat door design
- Excellent energy efficiency with inverter compressor
- Sealed crisper with humidity control
- Adjustable storage solutions
- SpillSafe™ glass shelves
- Lockable compartment



Overall Fridge dimensions* (including door):
1725h x 699w x 769d (mm)

Door is designed to sit proud



WRB3504WA

328L single door refrigerator, white with FlexStor

- Adjustable storage solutions with FlexStor™
- Combine with WFB2804SA for a pigeon pair
- SpillSafe™ glass shelves
- Electronic touch controls
- Quick chill function



Overall Fridge dimensions* (including door):
1746h x 595w x 700d (mm)

Door is designed to sit proud

RANGE

single door fridges



WRM2400WE

242L single door refrigerator, white

- Combine with WFM1700WE for a pigeon pair
- Reversible door
- 4 tempered glass shelves
- 4 full-width door bins
- LED fridge light
- Egg tray



Overall Fridge dimensions* (including door):
1434h x 550w x 545d (mm)

Door is designed to sit proud

RANGE
vertical freezers



WFB4204SC

388L single door freezer, stainless steel

- Stylish flat door design
- Excellent energy efficiency with inverter compressor
- 3 full width freezer baskets
- 4 SpillSafe™ glass shelves
- Quick freeze function
- Twist ice and serve



Overall Freezer dimensions* (including door):
1725h x 699w x 769d (mm)

Door is designed to sit proud

RANGE
vertical freezers



WFB2804SA

254L single door freezer, stainless steel

- Fingerprint resistant stainless steel
- Combine with WRB3504SA for a pigeon pair
- Twist ice and serve
- 6 full width freezer baskets
- Quick freeze function



Overall Freezer dimensions* (including door):
1746h x 595w x 700d (mm)

Door is designed to sit proud



WFB4204WC

388L single door freezer, white

- Stylish flat door design
- Excellent energy efficiency with inverter compressor
- 3 full width freezer baskets
- 4 SpillSafe™ glass shelves
- Quick freeze function
- Twist ice and serve
- LED lighting



Overall Freezer dimensions* (including door):
1725h x 699w x 769d (mm)

Door is designed to sit proud



WFB2804WA

254L single door freezer, white

- Combine with WRB3504WA for a pigeon pair
- Twist ice and serve
- 6 full width freezer baskets
- Electronic touch controls
- Quick freeze function



Overall Freezer dimensions* (including door):
1746h x 595w x 700d (mm)

Door is designed to sit proud

RANGE
vertical freezers



WFM1700WE

**155L single door
freezer, white**

- Combine with WRM2400WE for a pigeon pair
- Frost free
- Reversible doors
- 4 full-width freezer drawers
- Electronic control
- Door alarm



**Overall Freezer dimensions*
(including door):
1434h x 550w x 560d (mm)**

Door is designed to sit proud



FLEXSPACE

accessories

Westinghouse have designed a collection of clever accessories to complement your FlexSpace™ refrigerator. Choose one or add the whole collection to create the ultimately practical fridge interior to suit your family's needs.

FlexSpace™ bottle stop

ACC083

Stop your bottles of drink from rolling around the bottom shelf with the bottle lock. With its spring loaded design, the bottle stop allows you to safely lock your bottles into place above the crisper.

FlexSpace™ 70cm & 80cm pull-out shelves

ACC169/170

The pull-out shelf allows you to conveniently store and access those large and awkward items you would otherwise have trouble placing on your fridge shelf.

FlexStor small items bins

ACC084

Take advantage of the small spaces on your fridge door with the 2 small items bins. The narrow design allows you to conveniently store those small items that would otherwise get lost in your fridge.

FlexStor can dispenser

ACC082

The ultimate in chilled convenience. The FlexStor can dispenser allows you to quickly grab a chilled can of drink right from inside the door on your fridge.



INTEGRATION KIT

seamless integration

The Westinghouse Integrated Refrigeration Kit offers a simple and precise solution for a seamless kitchen. The specialised Westinghouse hinges also allow the fridge door to open to a wide 120°, making it easier to access food as well as clean and remove shelves. In order to prevent unnecessary running around and hidden costs, our unique kit comes complete with all parts to complete the installation, including the hinges.

How does it work?

The kit is designed to fit our compact top and bottom Westinghouse fridges. It utilises a sliding system which fixes the outer door of the fridge to the kitchen cabinet.

When the cabinet door is opened, the connecting rail opens the fridge in one smooth and simple motion.

IK007 APPLICABLE MODELS

top mount	bottom mount
WTB3700	WBB3400
WTB3400	WBB3700
WTB2800	
WTB2500	
WTB2300	





specifications

Large French door

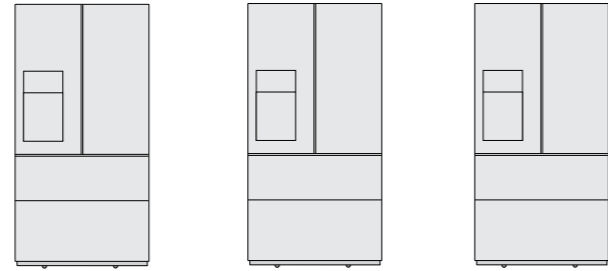

WHE6170BB WHE6170SB WHE6270SB

Features†

capacity (litres)	609	609	619
food compartment capacity (litres)	371	371	371
freezer compartment capacity (litres)	165	165	248
Convertible Compartment/Drawer capacity (litres)	73	73	
overall dimensions* H x W X D (mm) (including door)	1782 x 913 x 803	1782 x 913 x 803	1782 x 913 x 803
mark resistant real stainless steel door finish	✓	✓	✓
mark resistant dark real stainless steel door finish	✓	✓	✓
energy star rating	3.5	3.5	3.5
energy consumption (kWh/year)	485	485	497
frost-free	✓	✓	✓
DualCooling system	✓	✓	✓
electronic temperature controls	✓	✓	✓
separate temperature controls for fridge and freezer	✓	✓	✓
quick chill function	✓	✓	✓
quick freeze function	✓	✓	✓
holiday mode	✓	✓	✓
door alarm	fridge and freezer	fridge and freezer	fridge and freezer
fridge features			
filtered ice and water dispenser	✓	✓	✓
adjustable SpillSafe glass shelves	2	2	2
flip up shelf	1	1	1
slide away shelf	1	1	1
FreshSeal automatic humidity controlled crispers	2	2	2
easy glide crispers	✓	✓	✓
SnackZone	2	2	2
egg tray	1	1	1
deep bottle bins	1	1	1
expandable door bins	1	1	1
dairy compartment with lid (in door)	1	1	1
standard door bins	2	2	2
shallow door bins	2	2	2
interior lighting	LED	LED	LED
middle drawer features			
function	fridge and freezer	fridge and freezer	freezer
convertible drawer	convertible drawer	convertible drawer	
preset temperature settings	5	5	1
freezer (converts to bottom freezer temperature) -23°C / -15°C	✓	✓	
Ultra Chill -2°C	✓	✓	
cold drinks 0°C	✓	✓	
deli snacks 3°C	✓	✓	
wine and champagne 7°C	✓	✓	
drawer divider	✓	✓	✓
freezer features			
automatic ice maker	✓	✓	✓
twist and serve ice			
ice cube storage bin			
ice cube tray			
full width freezer drawers	1	1	1
full width basket with divider	1	1	1
freezer basket runner system	telescopic	telescopic	telescopic
freezer light	LED	LED	LED
other features			
R600a refrigerant	✓	✓	✓
hidden hinges	✓	✓	✓
front adjustable levelling feet	✓	✓	✓
rear rollers	✓	✓	✓
water filter accessory	ULX220 / ACC208	ULX220 / ACC208	ULX220 / ACC208

Large French door

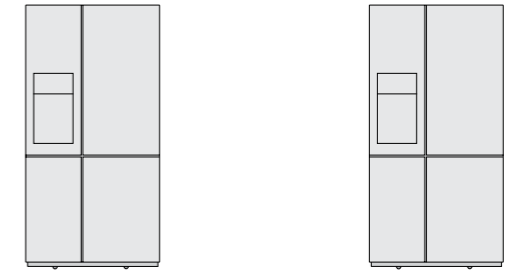

WQE6870BA WQE6870SA

Features†

capacity (litres)	609	609
food compartment capacity (litres)	371	371
freezer compartment capacity (litres)	147	147
convertible compartment (litres)	91	91
overall dimensions* H x W X D (mm) (including door)	1782 x 913 x 749	1782 x 913 x 749
mark resistant real stainless steel door finish	✓	✓
mark resistant dark real stainless steel door finish	✓	✓
energy star rating	3.5	3.5
energy consumption (kWh/year)	501	501
frost-free	✓	✓
DualCooling system	✓	✓
electronic temperature controls	✓	✓
separate temperature controls for fridge and freezer	✓	✓
quick chill function	✓	✓
quick freeze function	✓	✓
holiday mode	✓	✓
door alarm	fridge and freezer	fridge and freezer
fridge features		
filtered ice and water dispenser	✓	✓
adjustable SpillSafe glass shelves	2	2
flip up shelf	1	1
slide away shelf	1	1
FreshSeal automatic humidity controlled crispers	2	2
easy glide crispers	✓	✓
SnackZone	2	2
egg tray	1	1
deep bottle bins	1	1
expandable door bins	1	1
dairy compartment with lid (in door)	1	1
standard door bins	2	2
shallow door bins	2	2
interior lighting	LED	LED
lower left hand compartment features		
function	convertible compartment	convertible compartment
convertible compartment	✓	✓
preset temperature settings	5	5
freezer (converts to lower right freezer temperature) -23°C / -15°C	✓	✓
Ultra Chill -2°C	✓	✓
cold drinks 0°C	✓	✓
deli snacks 3°C	✓	✓
wine and champagne 7°C	✓	✓
Sliding shelf with wine rack	2	2
Sliding drawer	2	2
Standard door bins	2	2
freezer features		
automatic ice maker	✓	✓
Sliding shelf	2	2
Sliding drawer	2	2
Standard door bins	2	2
freezer light	LED	LED
other features		
R600a refrigerant	✓	✓
hidden hinges	✓	✓
front adjustable levelling feet	✓	✓
rear rollers	✓	✓
water filter accessory	ULX220 / ACC208	ULX220 / ACC208

* Overall dimensions include the door and handle. Refer to the dimensions sheet (on page 110 of the brochure) for more details.

† Refer to the product information on the back page of this brochure.

* Overall dimensions include the door and handle. Refer to the dimensions sheet (on page 110 of the brochure) for more details.

† Refer to the product information on the back page of this brochure.

Slim French door

designed to fit a 90cm cavity

Features†

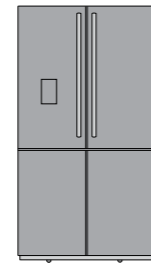

WQE6060BB

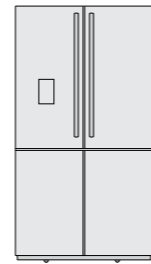

WQE6060SB

capacity (litres)	541	541
food compartment capacity (litres)	398	398
freezer compartment capacity (litres)	143	143
overall dimensions* H x W X D (mm) (including door)	1725 x 896 x 781	1725 x 896 x 781
mark resistant real stainless steel door finish		✓
mark resistant dark real stainless steel door finish	✓	
energy star rating	4	4
energy consumption (kWh/year)	382	382
frost-free	✓	✓
multi-flow air delivery system	✓	✓
electronic temperature controls	✓	✓
separate temperature controls for fridge and freezer	✓	✓
quick freeze function	✓	✓
drink chill timer & alarm	✓	✓
holiday mode	✓	✓
door alarm	fridge & freezer	fridge & freezer
fridge features		
filtered water dispenser	✓	✓
adjustable SpillSafe glass shelves	3	3
FreshSeal sealed humidity controlled crispers	✓	✓
FamilySafe lockable compartment	✓	✓
bottle rack	✓	✓
egg tray	✓	✓
bottle bins with retaining fingers	2	2
deep door bins	2	2
shallow door bins	3	3
interior lighting	LED	LED
feature lighting	blue LED	blue LED
freezer features		
automatic icemaker	plumbed	plumbed
twist ice and serve		
ice cube storage bin	✓	✓
self-close main freezer drawer		
freezer basket/drawer runner system	suspended	suspended
full width freezer basket		
3/4 width freezer drawer		
full width freezer storage bin	3	3
full width deep freezer storage bin	2	2
half width freezer storage bin	1	1
other features		
R600a refrigerant	✓	✓
hidden hinges	✓	✓
adjustable front rollers	✓	✓
rear rollers	✓	✓
water filter accessory	ULX220	ULX220

* Overall dimensions include the door and handle. Refer to the dimensions sheet (on page 110 of the brochure) for more details.

† Refer to the product information on the back page of this brochure.

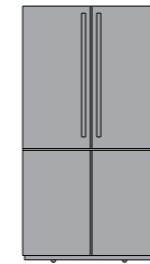

WQE6000BB

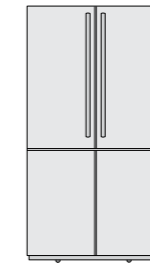

WQE6000SB

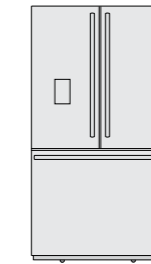

WHE6060SB

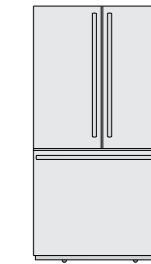

WHE6000SB

capacity (litres)	541	541	565	565
food compartment capacity (litres)	398	398	398	398
freezer compartment capacity (litres)	143	143	167	167
overall dimensions* H x W X D (mm) (including door)	1725 x 896 x 781	1725 x 896 x 781	1725 x 896 x 781	1725 x 896 x 781
mark resistant real stainless steel door finish		✓	✓	✓
mark resistant dark real stainless steel door finish	✓			
energy star rating	4	4	4	4
energy consumption (kWh/year)	382	382	382	382
frost-free	✓	✓	✓	✓
multi-flow air delivery system	✓	✓	✓	✓
electronic temperature controls	✓	✓	✓	✓
separate temperature controls for fridge and freezer	✓	✓	✓	✓
quick freeze function	✓	✓	✓	✓
drink chill timer & alarm			✓	
holiday mode			✓	
door alarm	fridge	fridge	fridge & freezer	fridge
fridge features				
filtered water dispenser			✓	
adjustable SpillSafe glass shelves	3	3	3	3
FreshSeal sealed humidity controlled crispers	✓	✓	✓	✓
FamilySafe lockable compartment	✓	✓	✓	✓
bottle rack	✓	✓	✓	✓
egg tray	✓	✓	✓	✓
bottle bins with retaining fingers	2	2	2	2
deep door bins	2	2	2	2
shallow door bins	3	3	3	3
interior lighting	LED	LED	LED	LED
feature lighting	blue LED	blue LED	blue LED	blue LED
freezer features				
automatic icemaker			plumbed	
twist ice and serve	✓	✓		✓
ice cube storage bin	✓	✓	✓	✓
self-close main freezer drawer			✓	✓
freezer basket/drawer runner system	suspended	suspended	telescopic	telescopic
full width freezer basket			1	1
3/4 width freezer drawer			1	1
full width freezer storage bin	3	3		
full width deep freezer storage bin	2	2		
half width freezer storage bin	1	1		
other features				
R600a refrigerant	✓	✓	✓	✓
hidden hinges	✓	✓	✓	✓
adjustable front rollers	✓	✓	✓	✓
rear rollers	✓	✓	✓	✓
water filter accessory			ULX220	

* Overall dimensions include the door and handle. Refer to the dimensions sheet (on page 110 of the brochure) for more details.

† Refer to the product information on the back page of this brochure.

Compact French door

Features†



WHE5204BC

capacity (litres)	491
food compartment capacity (litres)	345
freezer compartment capacity (litres)	146
overall dimensions* H x W X D (mm) (including door)	1725 x 796 x 769
mark resistant real stainless steel door finish	
mark resistant dark real stainless steel door finish	✓
stylish flat door design	✓
energy star rating	4
energy consumption (kWh/year)	363
inverter compressor motor	✓
frost-free	✓
multi-flow air delivery system	✓
electronic temperature controls	✓
separate temperature controls for fridge and freezer	✓
quick freeze function	✓
drink chill timer & alarm	
holiday mode	
door alarm	fridge
fridge features	
filtered water dispenser	
adjustable SpillSafe glass shelves	3
FreshSeal humidity controlled crisper	✓
FamilySafe lockable compartment	✓
egg tray	✓
bottle bins with retaining fingers	2
deep door bins	2
shallow door bins	3
interior lighting	LED
feature lighting	blue LED
freezer features	
automatic icemaker	
twist ice and serve	✓
ice cube storage bin	✓
self-close main freezer drawer	✓
freezer basket/drawer runner system	telescopic
large freezer basket	1
freezer drawer full width	1
freezer drawer 3/4 width	1
other features	
R600a refrigerant	✓
hidden hinges	✓
adjustable front rollers	✓
rear rollers	✓
water filter accessory	

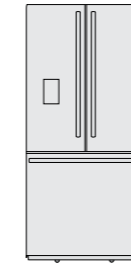

WHE5264SC

capacity (litres)	491	491
food compartment capacity (litres)	345	345
freezer compartment capacity (litres)	146	146
overall dimensions* H x W X D (mm) (including door)	1725 x 796 x 769	1725 x 796 x 769
mark resistant real stainless steel door finish	✓	✓
mark resistant dark real stainless steel door finish		
stylish flat door design	✓	✓
energy star rating	4	4
energy consumption (kWh/year)	363	363
inverter compressor motor	✓	✓
frost-free	✓	✓
multi-flow air delivery system	✓	✓
electronic temperature controls	✓	✓
separate temperature controls for fridge and freezer	✓	✓
quick freeze function	✓	✓
drink chill timer & alarm	✓	
holiday mode	✓	
door alarm	fridge & freezer	fridge
fridge features		
filtered water dispenser	✓	
adjustable SpillSafe glass shelves	3	3
FreshSeal humidity controlled crisper	✓	✓
FamilySafe lockable compartment	✓	✓
egg tray	✓	✓
bottle bins with retaining fingers	2	2
deep door bins	2	2
shallow door bins	3	3
interior lighting	LED	LED
feature lighting	blue LED	blue LED
freezer features		
automatic icemaker		
twist ice and serve		✓
ice cube storage bin	✓	✓
self-close main freezer drawer	✓	✓
freezer basket/drawer runner system	telescopic	telescopic
large freezer basket	1	1
freezer drawer full width	1	1
freezer drawer 3/4 width	1	1
other features		
R600a refrigerant	✓	✓
hidden hinges	✓	✓
adjustable front rollers	✓	✓
rear rollers	✓	✓
water filter accessory	ULX220	

* Overall dimensions include the door and handle. Refer to the dimensions sheet (on page 110 of the brochure) for more details.

† Refer to the product information on the back page of this brochure.

Large bottom mount

Features[†]



WBE4504BC

capacity (litres)	425
food compartment capacity (litres)	300
freezer compartment capacity (litres)	125
overall dimensions* H x W X D (mm) (including door)	1725 x 699 x 769
door finish	dark real stainless steel
stylish flat door design	✓
energy star rating new	4.5
energy consumption (kWhr/yr)	292
inverter compressor motor	✓
frost-free	✓
electronic temperature controls	✓
quick freeze function	✓
door alarm	fridge
separate temperature controls for fridge & freezer	✓
fridge features	
adjustable SpillSafe glass shelves	✓
FreshSeal humidity controlled crisper	✓
half width door bins	3
shallow bin	1
deep bottle bins	1
FamilySafe lockable compartment	✓
feature lighting	blue LED
main light	LED
freezer features	
ice cube storage bin	✓
twist ice and serve	2 trays
large freezer storage drawer	✓
freezer drawer full-width	✓
freezer drawer 3/4 width	✓
freezer basket/drawer runner system	telescopic
other features	
door opening	left or right hand
hidden hinges	✓
adjustable front rollers	✓
rear rollers	✓

* Overall dimensions include the door and handle. Refer to the dimensions sheet (on page 110 of the brochure) for more details.

[†] Refer to the product information on the back page of this brochure.



WBE4504SC

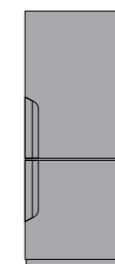

WBE4500BC

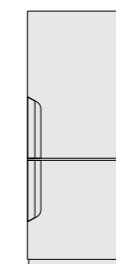

WBE4500SC

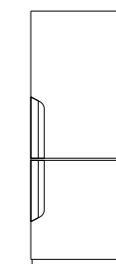

WBE4500WC

capacity (litres)	425	425	425	425
food compartment capacity (litres)	300	300	300	300
freezer compartment capacity (litres)	125	125	125	125
overall dimensions* H x W X D (mm) (including door)	1725 x 699 x 769	1725 x 699 x 723	1725 x 699 x 723	1725 x 699 x 723
door finish	real stainless steel	dark real stainless steel	real stainless steel	white
stylish flat door design	✓	✓	✓	✓
energy star rating new	4.5	4.5	4.5	4.5
energy consumption (kWhr/yr)	292	292	292	292
inverter compressor motor	✓	✓	✓	✓
frost-free	✓	✓	✓	✓
electronic temperature controls	✓	✓	✓	✓
quick freeze function	✓	✓	✓	✓
door alarm	fridge	fridge	fridge	fridge
separate temperature controls for fridge & freezer	✓	✓	✓	✓
fridge features				
adjustable SpillSafe glass shelves	✓	✓	✓	✓
FreshSeal humidity controlled crisper	✓	✓	✓	✓
half width door bins	3	3	3	3
shallow bin	1	1	1	1
deep bottle bins	1	1	1	1
FamilySafe lockable compartment	✓	✓	✓	✓
feature lighting	blue LED	blue LED	blue LED	blue LED
main light	LED	LED	LED	LED
freezer features				
ice cube storage bin	✓	✓	✓	✓
twist ice and serve	2 trays	2 trays	2 trays	2 trays
large freezer storage drawer	✓	✓	✓	✓
freezer drawer full-width	✓	✓	✓	✓
freezer drawer 3/4 width	✓	✓	✓	✓
freezer basket/drawer runner system	telescopic	telescopic	telescopic	telescopic
other features				
door opening	left or right hand	left or right hand	left or right hand	left or right hand
hidden hinges	✓	✓	✓	✓
adjustable front rollers	✓	✓	✓	✓
rear rollers	✓	✓	✓	✓

* Overall dimensions include the door and handle. Refer to the dimensions sheet (on page 110 of the brochure) for more details.

[†] Refer to the product information on the back page of this brochure.

Large bottom mount

Features[†]



WBE5304BC

capacity (litres)	496
food compartment capacity (litres)	351
freezer compartment capacity (litres)	145
overall dimensions* H x W X D (mm) (including door)	1725 x 796 x 769
door finish	dark real stainless steel
stylish flat door design	✓
energy star rating new	5
energy consumption (kWhr/yr)	309
inverter compressor motor	✓
frost-free	✓
electronic temperature controls	✓
quick freeze function	✓
door alarm	fridge
separate temperature controls for fridge & freezer	✓
fridge features	
adjustable SpillSafe glass shelves	✓
FreshSeal humidity controlled crisper	✓
half width door bins	3
shallow bin	1
deep bottle bins	1
FamilySafe lockable compartment	✓
feature lighting	blue LED
main light	LED
freezer features	
ice cube storage bin	✓
twist ice and serve	2 trays
large freezer storage drawer	✓
freezer drawer full-width	✓
freezer drawer 3/4 width	✓
freezer basket runner/drawer system	telescopic
other features	
door opening	left or right hand
hidden hinges	✓
adjustable front rollers	✓
rear rollers	✓

* Overall dimensions include the door and handle. Refer to the dimensions sheet (on page 110 of the brochure) for more details.

[†] Refer to the product information on the back page of this brochure.



WBE5304SC

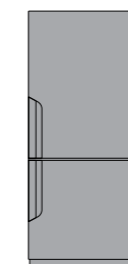

WBE5300BC

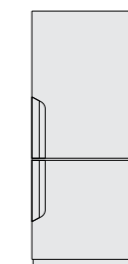

WBE5300SC

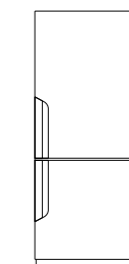

WBE5300WC

capacity (litres)	496	496	496	496
food compartment capacity (litres)	351	351	351	351
freezer compartment capacity (litres)	145	145	145	145
overall dimensions* H x W X D (mm) (including door)	1725 x 796 x 769	1725 x 796 x 723	1725 x 796 x 723	1725 x 796 x 723
door finish	real stainless steel	dark real stainless steel	real stainless steel	white
stylish flat door design	✓	✓	✓	✓
energy star rating new	5	5	5	5
energy consumption (kWhr/yr)	309	309	309	309
inverter compressor motor	✓	✓	✓	✓
frost-free	✓	✓	✓	✓
electronic temperature controls	✓	✓	✓	✓
quick freeze function	✓	✓	✓	✓
door alarm	fridge	fridge	fridge	fridge
separate temperature controls for fridge & freezer	✓	✓	✓	✓
fridge features				
adjustable SpillSafe glass shelves	✓	✓	✓	✓
FreshSeal humidity controlled crisper	✓	✓	✓	✓
half width door bins	3	3	3	3
shallow bin	1	1	1	1
deep bottle bins	1	1	1	1
FamilySafe lockable compartment	✓	✓	✓	✓
feature lighting	blue LED	blue LED	blue LED	blue LED
main light	LED	LED	LED	LED
freezer features				
ice cube storage bin	✓	✓	✓	✓
twist ice and serve	2 trays	2 trays	2 trays	2 trays
large freezer storage drawer	✓	✓	✓	✓
freezer drawer full-width	✓	✓	✓	✓
freezer drawer 3/4 width	✓	✓	✓	✓
freezer basket runner/drawer system	telescopic	telescopic	telescopic	telescopic
other features				
door opening	left or right hand	left or right hand	left or right hand	left or right hand
hidden hinges	✓	✓	✓	✓
adjustable front rollers	✓	✓	✓	✓
rear rollers	✓	✓	✓	✓

* Overall dimensions include the door and handle. Refer to the dimensions sheet (on page 110 of the brochure) for more details.

[†] Refer to the product information on the back page of this brochure.

Compact bottom mount

Features[†]



WBB3700AH

capacity (litres)	346
food compartment capacity (litres)	258
freezer compartment capacity (litres)	88
overall dimensions* H x W X D (mm) (including door)	1755 x 598 x 650
door finish	arctic silver
energy star rating	3.5
energy consumption (kWh/year)	315
frost-free	✓
multi-flow air delivery system	✓
separate temperature controls for fridge & freezer	✓
fridge door alarm	✓
fridge features	
adjustable glass shelves	3
full-width humidity controlled crisper bin	✓
dairy compartment	✓
full-width bottle bins	1
1/3 door bins	2
2/3 door bins	2
egg tray	✓
interior fridge light	LED
freezer features	
twist ice server/storage bin	✓
freezer basket (half-width)	1
freezer basket (full-width)	2
other features	
R600a refrigerant	✓
hidden hinges	✓
door opening	reversible ¹
rear rollers	✓
levelling legs	✓
integration kit available	✓

* Overall dimensions include the door and handle. Refer to the dimensions sheet (on page 110 of the brochure) for more details.

[†] Refer to the product information on the back page of this brochure.



WBB3700WH



WBB3400AH

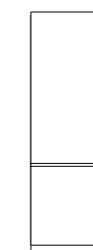

WBB3400WG

capacity (litres)	346	317	317
food compartment capacity (litres)	258	229	229
freezer compartment capacity (litres)	88	88	88
overall dimensions* H x W X D (mm) (including door)	1755 x 598 x 650	1645 x 598 x 650	1645 x 598 x 650
door finish	white	arctic silver	white
energy star rating	3.5	3.5	3.5
energy consumption (kWh/year)	315	310	310
frost-free	✓	✓	✓
multi-flow air delivery system	✓	✓	✓
separate temperature controls for fridge & freezer	✓	✓	✓
fridge door alarm	✓	✓	✓
fridge features			
adjustable glass shelves	3	3	3
full-width humidity controlled crisper bin	✓	✓	✓
dairy compartment	✓	✓	✓
full-width bottle bins	1	1	1
1/3 door bins	2	2	2
2/3 door bins	2	2	2
egg tray	✓	✓	✓
interior fridge light	LED	LED	LED
freezer features			
twist ice server/storage bin	✓	✓	✓
freezer basket (half-width)	1	1	1
freezer basket (full-width)	2	2	2
other features			
R600a refrigerant	✓	✓	✓
hidden hinges	✓	✓	✓
door opening	reversible ¹	reversible ¹	reversible ¹
rear rollers	✓	✓	✓
levelling legs	✓	✓	✓
integration kit available	✓	✓	✓

* Overall dimensions include the door and handle. Refer to the dimensions sheet (on page 110 of the brochure) for more details.

[†] Refer to the product information on the back page of this brochure.

Large top mount

Features[†]

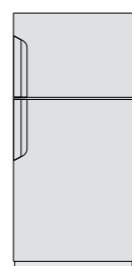

WTB4600SC

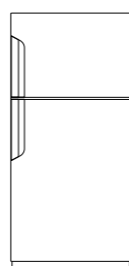

WTB4600WC

capacity (litres)	431	431
food compartment capacity (litres)	329	329
freezer compartment capacity (litres)	102	102
overall dimensions* H x W X D (mm) (including door)	1725 x 699 x 723	1725 x 699 x 723
door finish	real stainless steel	White
stylish flat door design	✓	✓
energy star rating new	4	4
energy consumption (kWhr/yr)	336	336
inverter compressor motor	✓	✓
frost-free	✓	✓
electronic temperature controls	✓	✓
quick chill alarm	✓	✓
door alarm	fridge	fridge
separate temperature controls for fridge & freezer	✓	✓

fridge features		
adjustable SpillSafe glass shelves	2	2
FreshSeal humidity controlled crisper	✓	✓
half width door bins	4	4
shallow bin	1	1
deep bottle bins	1	1
bottle fingers	✓	✓
chiller compartment	full-width	full-width
Family Safe lockable compartment	✓	✓
feature lighting	blue LED	blue LED
main light	LED	LED

freezer features		
ice cube storage bin	✓	✓
twist ice and serve	2	2
SpillSafe glass shelf	1	1
full-width door bin	1	1

other features		
door opening	left or right hand	left or right hand
hidden hinges	✓	✓
adjustable front rollers	✓	✓
rear rollers	✓	✓

* Overall dimensions include the door and handle. Refer to the dimensions sheet (on page 110 of the brochure) for more details.

[†] Refer to the product information on the back page of this brochure.



WTB4604SC

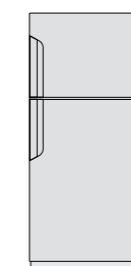

WTB5400SC

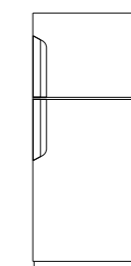

WTB5400WC



WTB5404SC

capacity (litres)	431	503	503	503
food compartment capacity (litres)	329	384	384	384
freezer compartment capacity (litres)	102	119	119	119
overall dimensions* H x W X D (mm) (including door)	1725 x 699 x 769	1725 x 796 x 723	1725 x 796 x 723	1725 x 796 x 769
door finish	real stainless steel	real stainless steel	White	real stainless steel
stylish flat door design	✓	✓	✓	✓
energy star rating new	4	4	4	4
energy consumption (kWhr/yr)	336	353	353	353
inverter compressor motor	✓	✓	✓	✓
frost-free	✓	✓	✓	✓
electronic temperature controls	✓	✓	✓	✓
quick chill alarm	✓	✓	✓	✓
door alarm	fridge	fridge	fridge	fridge
separate temperature controls for fridge & freezer	✓	✓	✓	✓

fridge features				
adjustable SpillSafe glass shelves	2	2	2	2
FreshSeal humidity controlled crisper	✓	✓	✓	✓
half width door bins	4	4	4	4
shallow bin	1	1	1	1
deep bottle bins	1	1	1	1
bottle fingers	✓	✓	✓	✓
chiller compartment	full-width	small + large	small + large	small + large
Family Safe lockable compartment	✓	✓	✓	✓
feature lighting	blue LED	blue LED	blue LED	blue LED
main light	LED	LED	LED	LED

freezer features				
ice cube storage bin	✓	✓	✓	✓
twist ice and serve	2	2	2	2
SpillSafe glass shelf	1	1	1	1
full-width door bin	1	1	1	1

other features				
door opening	left or right hand	left or right hand	left or right hand	left or right hand
hidden hinges	✓	✓	✓	✓
adjustable front rollers	✓	✓	✓	✓
rear rollers	✓	✓	✓	✓

Compact top mount

Features†



WTB3700AH/WH



WTB3400AH/WH

capacity (litres)	350	320
food compartment capacity (litres)	275	245
freezer compartment capacity (litres)	75	75
overall dimensions* H x W X D (mm) (including door)	1755 x 598 x 650	1645 x 598 x 650
door finish	arctic silver/white	arctic silver/white
energy star rating	3	3
energy consumption (kWh/year)	349	343
frost-free	✓	✓
multi-flow air delivery system	✓	✓
separate temperature controls for fridge & freezer	✓	✓
fridge door alarm	✓	✓
fingerprint-resistant surface	✓	✓
fridge features		
adjustable glass shelves	3	3
full-width chiller compartment	✓	✓
bottle caddy	✓	✓
full-width humidity controlled crisper bin	✓	✓
full-width door bins	2	2
1/3 door bins	2	2
2/3 door bins	2	2
interior fridge light	LED	LED
freezer features		
easy clean glass shelves	✓	✓
wire/plastic shelves		
twist ice server/storage bin	✓	✓
full-width door bins	2	2
other features		
R600a refrigerant	✓	✓
hidden hinges	✓	✓
door opening	reversible ¹	reversible ¹
rear rollers	✓	✓
levelling legs	✓	✓
integration kit available	✓	✓



WTB2800AH/WH



WTB2500WH

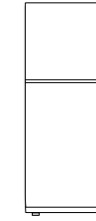

WTB2300WH

capacity (litres)	256	225	211
food compartment capacity (litres)	194	163	149
freezer compartment capacity (litres)	62	62	62
overall dimensions* H x W X D (mm) (including door)	1605 x 540 x 615	1470 x 540 x 615	1405 x 540 x 615
door finish	arctic silver/white	classic white	classic white
energy star rating	3	3	3
energy consumption (kWh/year)	283	279	259
frost-free	✓	✓	✓
multi-flow air delivery system	✓	✓	✓
separate temperature controls for fridge & freezer	✓	✓	✓
fridge door alarm	✓	✓	✓
fingerprint-resistant surface			
fridge features			
adjustable glass shelves	2	2	2
full-width chiller compartment	✓	✓	✓
bottle caddy			
full-width humidity controlled crisper bin	✓	✓	✓
full-width door bins	2	2	2
1/3 door bins	3	3	3
interior fridge light	LED	LED	LED
freezer features			
easy clean glass shelves			
wire/plastic shelves	✓	✓	✓
twist ice server/storage bin	✓	✓	✓
full-width door bins	2	2	2
other features			
R600a refrigerant	✓	✓	✓
hidden hinges	✓	✓	✓
door opening	reversible ¹	reversible ¹	reversible ¹
rear rollers			
levelling legs	✓	✓	✓
integration kit available	✓	✓	✓

¹ For those wanting a left hand opening door for models WTB2300, WTB2500, WTB2800, WTB3400 or WTB3700, please order reversing kit ACC096.

² No additional parts required to reverse the doors for models WTM200WC & WTM1800WC.

* Overall dimensions include the door and handle. Refer to the dimensions sheet (on page 110 of the brochure) for more details.

† Refer to the product information on the back page of this brochure.

Large side by sides

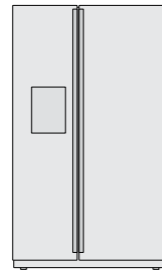

WSE6870SA

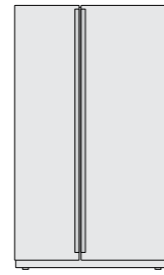

WSE6900SA/WA

Features[†]

capacity (litres)	585	612
food compartment capacity (litres)	406	408
freezer compartment capacity (litres)	179	204
overall dimensions* H x W X D (mm) (including door)	1787 x 1000 x 784	1787 x 1000 x 784
door finish	real stainless steel	real stainless steel/classic white
energy star rating	2.5	3
energy consumption (kWh/year)	567	525
filtered ice and water dispenser (cubed & crushed ice)	✓	✓
frost-free	✓	✓
separate temperature controls for fridge and freezer	✓	✓
fingerprint-resistant surface	✓	✓
electronic controls		
door alarm	✓	✓
drinks chill timer	✓	✓
quick freeze function	✓	✓
fridge features		
FlexStor door bins	4	4
humidity controlled crispers	2	2
adjustable SpillSafe glass shelves	4	4
FamilySafe compartment	1	1
bottle bin/with bottle fingers	2/✓	2/✓
shallow door bin	1	1
interior fridge light	LED	LED
bottle rack	✓	WSE6900SA only
freezer features		
removable ice bin	✓	✓
freezer bins	2	2
SpillSafe slide-out glass shelves	4	4
adjustable freezer door bins	3	6
twist ice and serve		✓
interior freezer light	LED	LED
other features		
adjustable front rollers	✓	✓
rear rollers	✓	✓
water filter accessory	ULX220	

* Overall dimensions include the door and handle. Refer to the dimensions sheet (on page 110 of the brochure) for more details.

[†] Refer to the product information on the back page of this brochure.

Compact side by sides

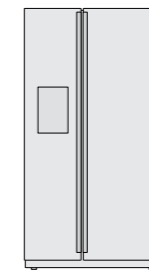

WSE6170SA

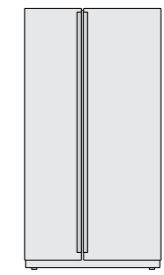

WSE6200SA/WA

Features[†]

capacity (litres)	515	542
food compartment capacity (litres)	336	338
freezer compartment capacity (litres)	179	204
overall dimensions* H x W X D (mm) (including door)	1787 x 912 x 784	1787 x 912 x 784
door finish	real stainless steel	real stainless steel/classic white
energy star rating	2.5	3
energy consumption (kWh/year)	536	499
filtered ice and water dispenser (cubed & crushed ice)	80	80
frost-free	✓	✓
fingerprint-resistant surface	✓	✓
electronic controls		
door alarm	✓	✓
drinks chill timer	✓	✓
quick freeze function	✓	✓
fridge features		
FlexStor door bins	4	4
blue feature lighting	✓	
FamilySafe lockable compartment	1	1
SpillSafe slide-out glass shelves	4	4
bottle rack	✓	WSE6200SA only
humidity controlled crisper	2	2
bottle bin/with bottle fingers	2/✓	2/✓
shallow door bin	1	1
egg tray	1	1
interior fridge light	LED	LED
freezer features		
removable ice bin	✓	✓
SpillSafe slide-out glass shelves	4	4
freezer basket	2	2
adjustable freezer door bins	3	5
twist ice and serve		✓
interior freezer light	LED	LED
other features		
adjustable front rollers	✓	✓
rear rollers	✓	✓
water filter accessory	ULX220	

* Overall dimensions include the door and handle. Refer to the dimensions sheet (or page XX of the brochure) for more details.

[†] Refer to the product information on the back page of this brochure.

Single door fridges

Features†



WRB5004SC

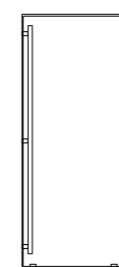

WRB5004WC



WRB3504SA

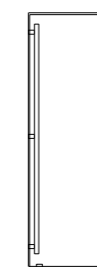

WRB3504WA

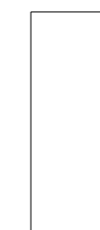

WRM2400WE

capacity (litres)	466
stylish flat door design	✓
door finish	stainless steel
overall dimensions* H x W X D (mm) (including door)	1725 x 699 x 769
energy star rating	4
energy consumption (kWh/year)	195
inverter compressor motor	✓
frost-free	✓
separate temperature control	✓
control functions	quick chill function
multi-flow air delivery system	✓
fridge features	
deli compartment	✓
adjustable SpillSafe glass shelves	✓
adjustable tempered glass shelves	
full width crisper bin	
FreshSeal humidity controlled crisper bin	1
FlexStor door bins	4
FamilySafe lockable compartment	✓
dairy compartment with lid	
adjustable full width bottle bins	
bottle fingers	2
egg tray	✓
interior fridge light	LED
other features	
R600a refrigerant	✓
door opening	left or right hand
adjustable front rollers	✓
adjustable front levelling leg	
rear rollers	✓
integration kit available	✓

466	328	328	242
✓			
classic white	stainless steel	classic white	classic white
1725 x 699 x 769	1746 x 595 x 700	1746 x 595 x 700	1434 x 550 x 545
4	3.5	3.5	3
195	182	182	175
✓			
✓	✓	✓	
✓	✓	✓	✓
quick chill function	quick chill function	quick chill function	
✓	✓	✓	
✓			
✓	✓	✓	
	2	2	✓
1			1
4	5	5	
✓			
	✓	✓	
			4
2			
✓	✓	✓	✓
LED	LED	LED	LED
✓	✓	✓	✓
left or right hand	reversible (included)	reversible (included)	reversible (included)
✓			
✓	✓	✓	✓
✓	✓	✓	✓
✓			

* Overall dimensions include the door and handle. Refer to the dimensions sheet (on page 110 of the brochure) for more details.
† Refer to the product information on the back page of this brochure.

Vertical freezers

Features†



WFB4204SC

capacity (litres)	388
stylish flat door design	✓
door finish	stainless steel
overall dimensions* H x W X D (mm) (including door)	1725 x 699 x 769
energy star rating	3.5
energy consumption (kWh/year)	309
inverter compressor motor	✓
frost-free	✓
separate temperature control	✓
multi-flow air delivery system	✓
freezer features	
twist ice and serve/trays	2/-
ice cube storage bin	✓
adjustable glass shelves	3
full-width freezer baskets	4
freezer light	LED
other features	
R600a refrigerant	✓
door opening	Left or right hand opening
adjustable front rollers	✓
adjustable front levelling leg	
rear rollers	✓
integration kit available	✓

* Overall dimensions include the door and handle. Refer to the dimensions sheet (on page 110 of the brochure) for more details.

† Refer to the product information on the back page of this brochure.



WFB4204WC



WFB2804SA



WFB2804WA

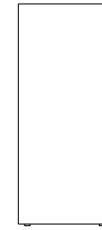

WFM1700WE

capacity (litres)	388	254	254	155
stylish flat door design	✓			
door finish	classic white	stainless steel	classic white	classic white
overall dimensions* H x W X D (mm) (including door)	1725 x 699 x 769	1746 x 595 x 700	1746 x 595 x 700	1434 x 550 x 560
energy star rating	3.5	3	3	3
energy consumption (kWh/year)	309	286	286	228
inverter compressor motor	✓			
frost-free	✓	✓	✓	✓
separate temperature control	✓	✓	✓	✓
multi-flow air delivery system	✓	✓	✓	✓
freezer features				
twist ice and serve/trays	2/-	2/-	2/-	
ice cube storage bin	✓	✓	✓	
adjustable glass shelves	3			1 (non-adjustable)
full-width freezer baskets	4	6	6	4
freezer light	LED	LED	LED	
other features				
R600a refrigerant	✓	✓	✓	✓
door opening	Left or right hand opening	reversible (included)	reversible (included)	reversible (included)
adjustable front rollers	✓			
adjustable front levelling leg		✓	✓	✓
rear rollers	✓	✓	✓	✓
integration kit available	✓			

Dimensions and installation guide

Large and compact side by sides†

WSE6900, WSE6870, WSE6200, WSE6170

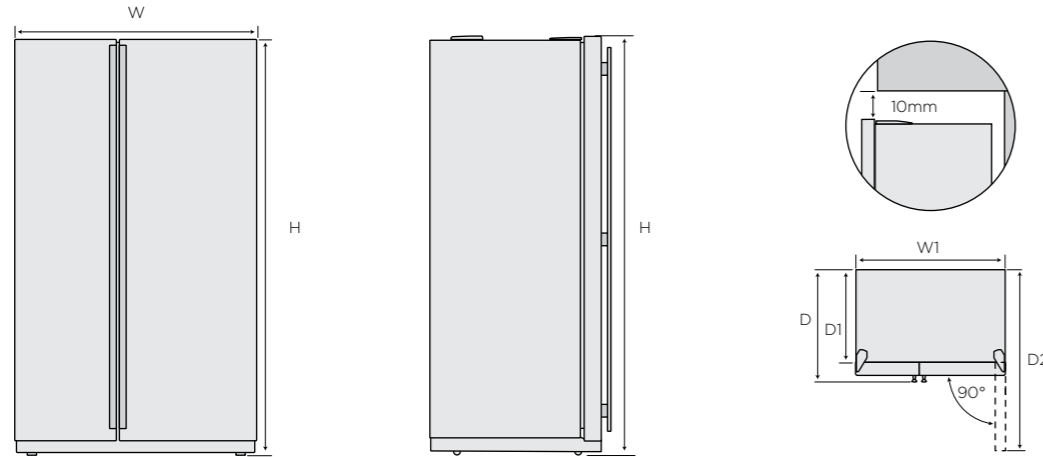

Recommended minimum clearances

Please note: Doors are designed to sit proud of cabinetry (not flush).

When positioned in a corner area, clearance of at least 350mm on the fridge side and 250mm on the freezer side will allow the doors to open enough to enable the removal of the bins and shelves.

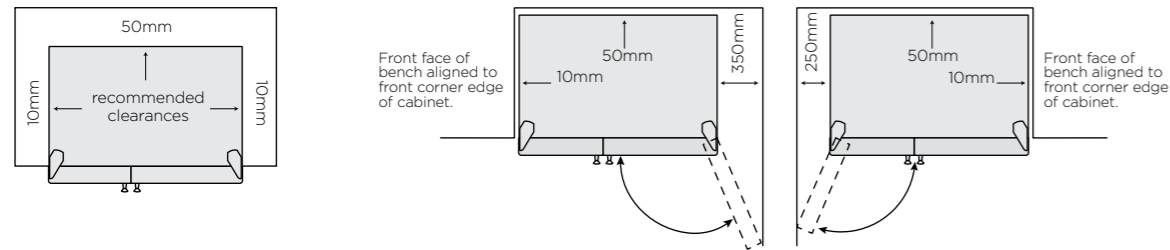

Verticals and pigeon pairs†

WRB5004, WFB4204, WRB3504, WFB2804

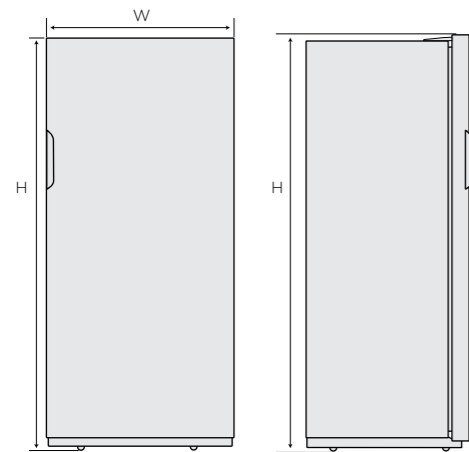

Recommended minimum clearances

Please note: Doors are designed to sit proud of cabinetry (not flush).

If you have a cupboard above the refrigerator with a rear gap of less than 100mm (Y), recommended minimum clearance at the top of the refrigerator increases from 30mm to 70mm (X).

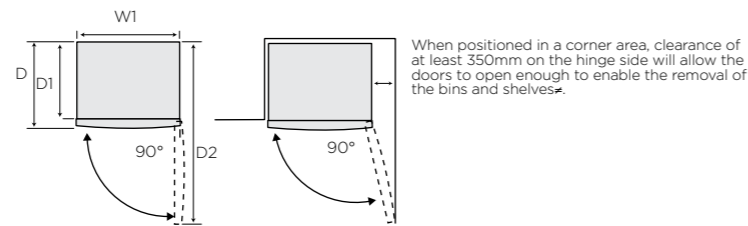
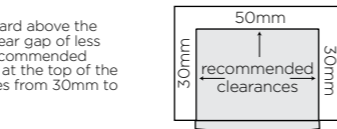

	Model	Door width (W)	Total depth (D)	Max height (H)	Cabinet width (W1)	Cabinet depth (D1)	Depth door open (D2)
Side by sides	WSE6900, WSE6870	1000	784	1787	993	610	1240
	WSE6200, WSE6170SA	912	784	1787	905	610	1150
Verticals and pigeon pairs	WRB5004, WFB4204	699	769	1725	693	641	1360
	WRB3504, WFB2804	595	700	1746	590	560	1175

† Refer to the product information on the back page of this brochure.

➤ For those single door models with telescopic extension slide-out bins or crispers situated with the door opening against the wall, clearance requirement increases from 350mm to 450mm. For information on installation of integration kits for top mounts, bottom mounts and pigeon pair models, please refer to westinghouse.com.au

Large and compact French doors†

WHE6060, WHE6000, WHE5204, WHE5264, WHE5204

WHE6874, WHE7074

WQE6060, WQE6000, WQE6000, WQE6060

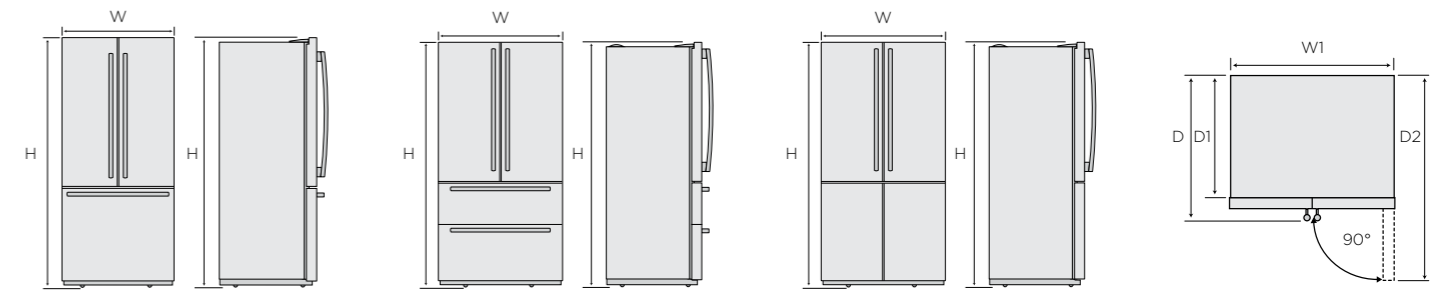

Recommended minimum clearances

Please note: Doors are designed to sit proud of cabinetry (not flush).

WHE6170, WHE6270

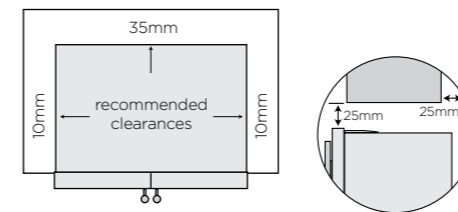

WQE6060, WQE6000, WHE6000, WHE6060, WQE6000, WQE6060

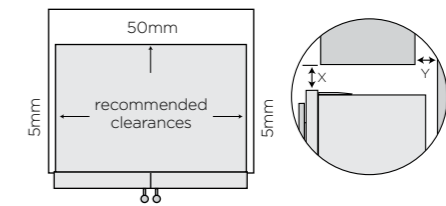

If you have a cupboard above the refrigerator with a rear gap of less than 100mm (Y), recommended minimum clearance at the top of the refrigerator increases from 30mm to 70mm (X).

WHE5204, WHE5264, WHE5204

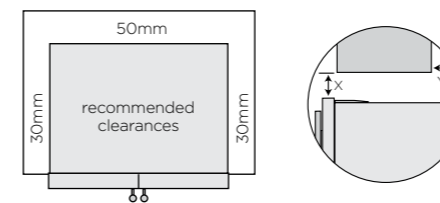

If you have a cupboard above the refrigerator with a rear gap of less than 100mm (Y), recommended minimum clearance at the top of the refrigerator increases from 30mm to 70mm (X).

WQE6000, WQE6060, WQE6060, WQE6000, WHE6060, WHE6000, WHE5204, WHE5264, WHE5204

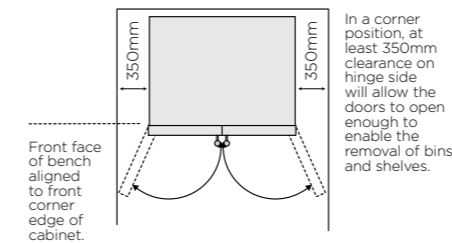

In a corner position, at least 350mm clearance on hinge side will allow the doors to open enough to enable the removal of bins and shelves.

WHE6170, WHE6270

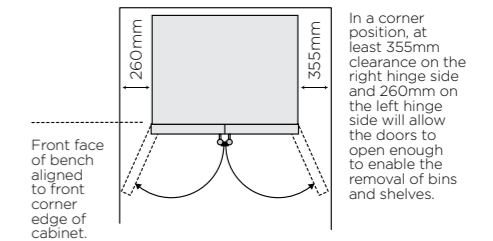

In a corner position, at least 355mm clearance on the right hinge side and 260mm on the left hinge side will allow the doors to open enough to enable the removal of bins and shelves.

	Model	Door width (W)	Total depth (D)	Max height (H)	Cabinet width (W1)	Cabinet depth (D1)	Depth door open (D2)
French door	WHE6170, WHE6270	913	803	1782	908	625	1189
	WQE6060, WQE6000, WHE6060, WHE6000, WQE6000, WQE6060	896	781	1725	890	641	1105
	WHE5204, WHE5264, WHE5204	796	769	1725	790	641	1057

† Refer to the product information on the back page of this brochure

Dimensions and installation guide

Large bottom mounts†

WBE5300, WBE5304, WBE4500, WBE4504

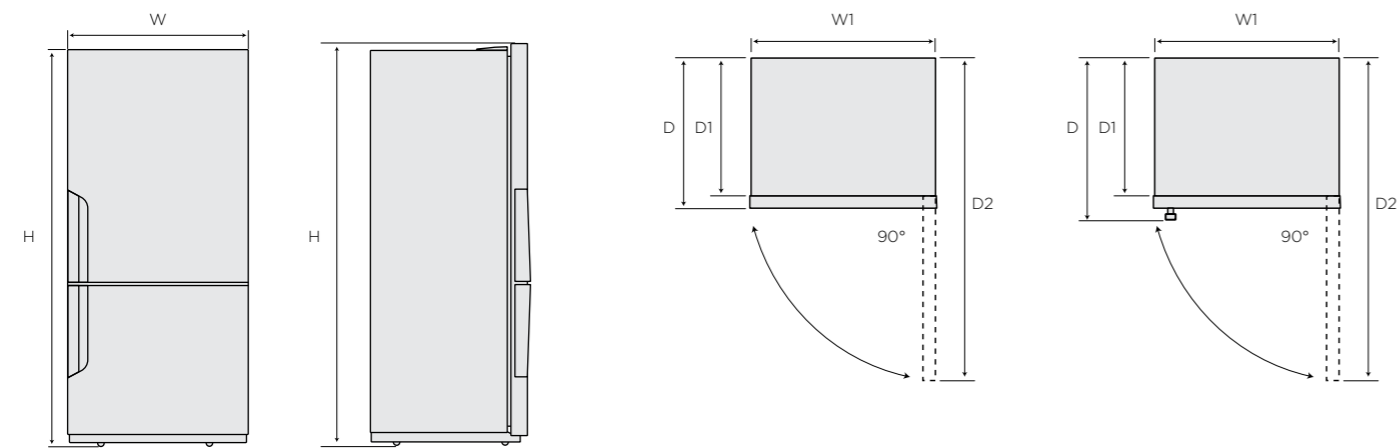

Recommended minimum clearances

Please note: Doors are designed to sit proud of cabinetry (not flush).

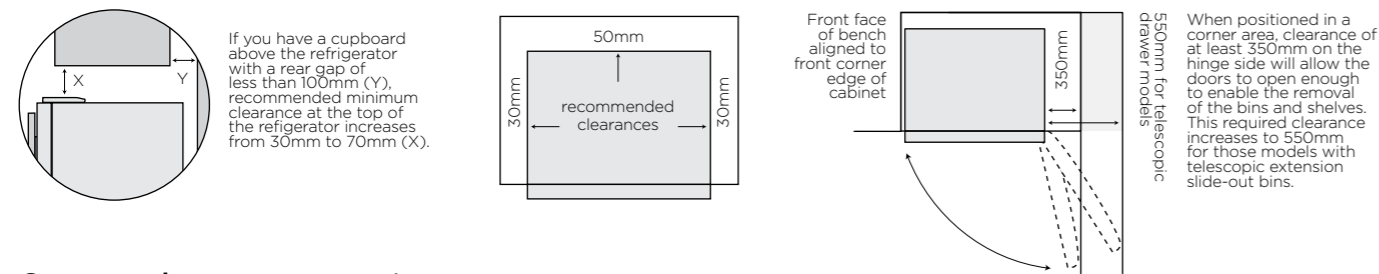

Compact bottom mounts†

WBB3700, WBB3400A

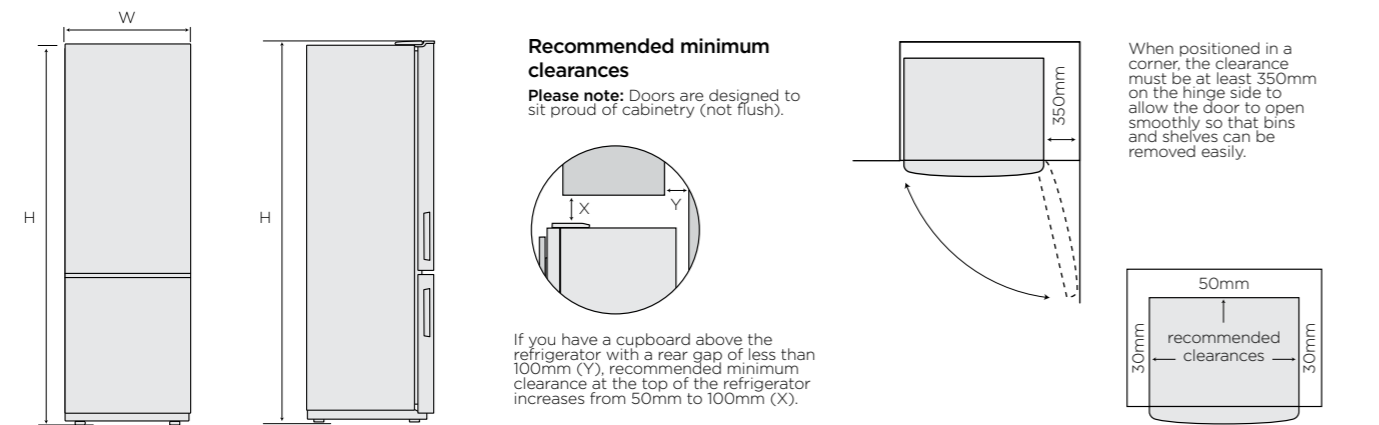

Recommended minimum clearances

Please note: Doors are designed to sit proud of cabinetry (not flush).

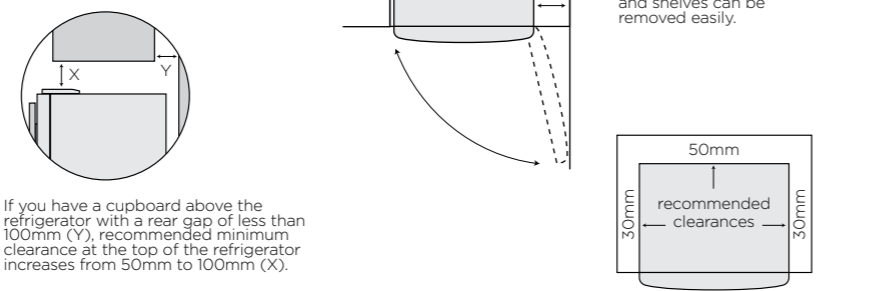

Large top mounts†

WTB5404, WTB5400, WTB4604, WTB4600

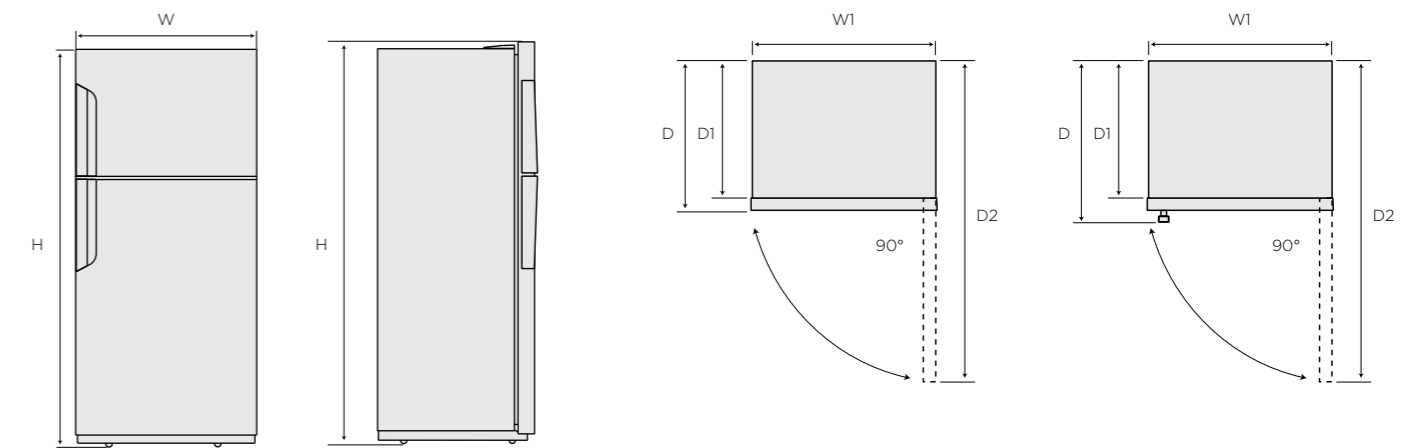

Recommended minimum clearances

Please note: Doors are designed to sit proud of cabinetry (not flush).

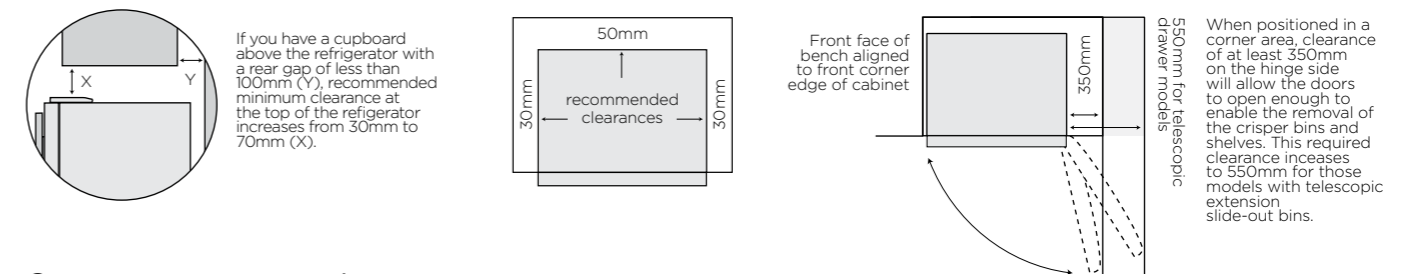

Compact top mounts†

WTB3700, WTB3400, WTB2800, WTB2500, WTB2300

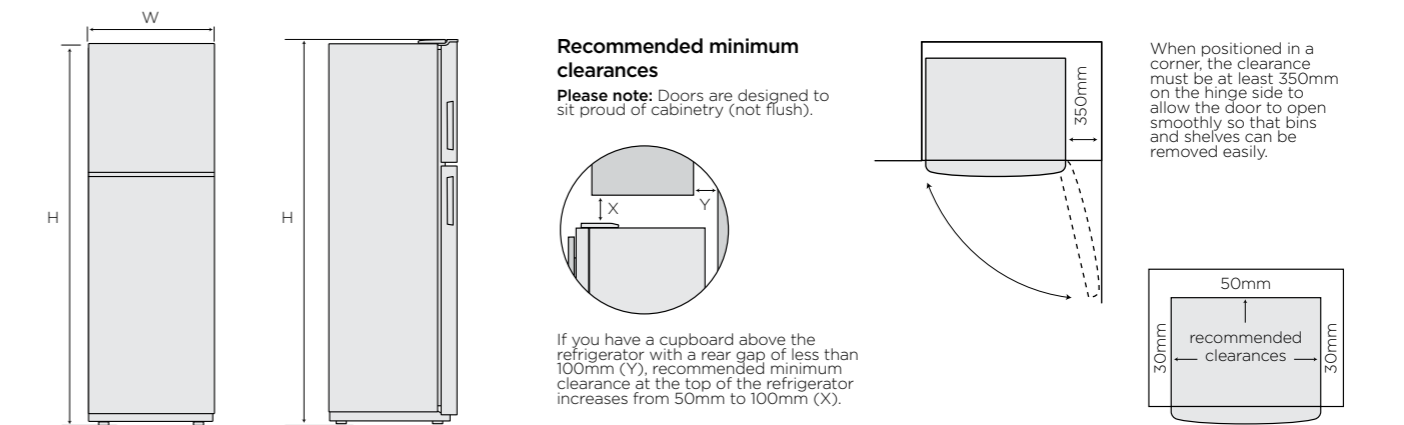

Recommended minimum clearances

Please note: Doors are designed to sit proud of cabinetry (not flush).

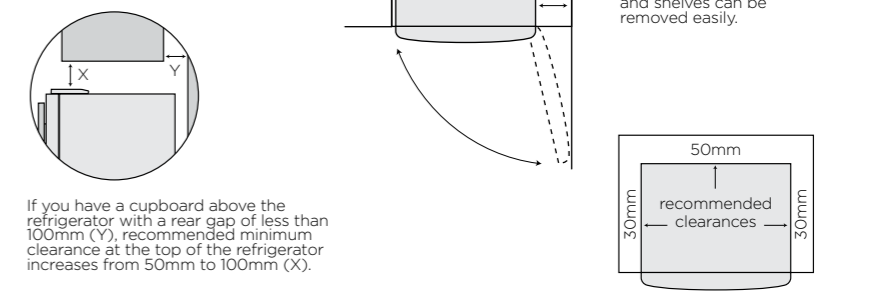

	Model	Door width (W)	Total depth (D)	Max height (H)	Cabinet width (W1)	Cabinet depth (D1)	Depth door open (D2)
Large bottom mounts	WBE5300	796	723	1725	790	641	1457
	WBE5304	796	769	1725	790	641	1457
	WBE4500	699	723	1725	693	641	1360
	WBE4504	699	769	1725	693	641	1360
Compact bottom mounts	WBB3700	598	650	1755	595	575	1199
	WBB3400	598	650	1645	595	575	1199

† Refer to the product information on the back page of this brochure. For information on installation of integration kits for top mounts, bottom mounts and pigeon pair models, please refer to westinghouse.com.au

	Model	Door width (W)	Total depth (D)	Max height (H)	Cabinet width (W1)	Cabinet depth (D1)	Depth door open (D2)
Large top mounts	WTB5404	796	769	1725	790	641	1457
	WTB5400	796	723	1725	790	641	1457
	WTB4604	699	769	1725	693	641	1360
	WTB4600	699	723	1725	693	641	1360
Compact top mounts	WTB3700	598	650	1755	595	575	1199
	WTB3400	598	650	1645	595	575	1199
	WTB2800	540	615	1605	540	540	1108
	WTB2500	540	615	1470	540	540	1108
	WTB2300	540	615	1405	540	540	1108

† Refer to the product information on the back page of this brochure. For information on installation of integration kits for top mounts, bottom mounts and pigeon pair models, please refer to westinghouse.com.au



For more information on all Westinghouse appliances, or for dimension and installation information, call into your retailer, phone or email our customer care team or visit our website:

AUSTRALIA

phone: 13 13 49

email: customercare@electrolux.com.au

web: westinghouse.com.au

NEW ZEALAND

phone: 0800 10 66 10

email: customercare@electrolux.co.nz

web: westinghouse.co.nz



We invite you to follow Westinghouse appliances and get involved in the conversation.

Warranty

Electrolux Home Products Pty Ltd and Electrolux (NZ) Limited (collectively Electrolux) warrants that for domestic applications the Appliances featured in this brochure are free from defects in materials and workmanship for 2 years, an additional 3 year warranty is also provided for the sealed refrigeration system, and warrants that for featured accessories a period of 12 months, following the date of original purchase and subject to the conditions set out in the warranty card accompanying the product when purchased. This warranty is in addition to the other rights and warranties you may have under the Australian Consumer Law (ACL) and Electrolux will at all times comply with its obligations at law including the ACL. For New Zealand customers Electrolux will at all times comply with its obligations pursuant to law including the Consumer Guarantees Act, the Sale of Goods Act and the Fair Trading Act. Where appliances are purchased in NZ for commercial purposes the Consumer Guarantees Act does not apply.

* Product information

The descriptors and illustrations in this publication apply to the specific products and models described as at the date of issue. Under our policy of continuous product development, product specifications may change without notice. Prospective purchasers should therefore check with their retailer to ensure this publication correctly describes the products that are being offered for sale. All information supplied is to be used for general reference purposes only and is on the understanding that Electrolux will not be liable for any loss, liability or damage of whatever kind arising as a result of reliance on such information. Electrolux will at all times comply with its obligations pursuant to law. Colours of products illustrated are as close as printing limitations allow.

FlexSpace™, FlexStor, FamilySafe, FlexFresh™, SpillSafe and StoreSafe™ are used by Electrolux Home Products Pty Ltd.

® and WESTINGHOUSE are trademarks of Westinghouse Electric Corporation. Used under license by Electrolux Home Products Pty Ltd. All Rights Reserved.

© 2021 Electrolux Home Products Pty Ltd. ABN 51 004 762 341 W_BRO_Fridge_Oct21