

# fridges



Westinghouse

# They say the kitchen is the heart and soul of every home.

14 Large French door

---

24 Slim French door

---

32 Compact French door

---

38 Large bottom mount

---

48 Compact bottom mount

---

54 Large top mount

---

62 Compact top mount

---

70 Side by sides

---

78 Verticals and pigeon pairs

---

90 Accessories

---

92 Integration

---

94 Specifications

---

118 Dimensions

---

After all, the way to everyone's heart is through their stomach. We aren't about fancy features, just beautiful designs that work, created with the freshest produce in mind. Our new Westinghouse fridge range is evolving with today's modern household, combining functionality with style. Simple design that allows your family to create and live with ease. That's why we created FlexSpace. A humble solution for your family's fridge needs, that allows you to configure the interior any way you want.

Showcasing a stylish flat door design, our range is available in dark or natural real stainless steel and white to compliment your kitchen and lifestyle. With consideration for the environment, our new models have been designed to be energy efficient, keeping your costs down and allowing you to care for your surroundings.



## choose the right fridge with Westinghouse

A fridge is a vital part of every home, but with so many to choose from it can be difficult to know which one is right for your family. So, to help you find your perfect fridge, we've put together some helpful guidelines and questions to consider.

### type & style

- Think about the style of your kitchen. Would white, dark, stainless steel or arctic silver suit your space?
- Do you have limited space but still want all the benefits of a large fridge in a slimmer model?
- Do you like the aesthetics of a French door model and the idea of an ice and water dispenser?
- Do you tend to have a lot of frozen food or do you need more fresh food and drinks storage?

### dimensions

- Does the fridge need to fit into an existing space? Make sure you measure your kitchen cavity and doorways before choosing a fridge.
- Remember that fridges need air space around them to keep them running at their best. Check this when considering which models will fit your kitchen cavity.

### capacity

- As a general rule a family of two needs around 300L of food storage space. For each additional family member add around 60L.
- Remember your family may grow in the future, so when in doubt, go for a larger size. Larger fridges tend to have more features and are more efficient.

### flexible interiors

- Are storage space and flexible interiors important to you?
- Do you like to entertain or regularly need to fit a lot of food and drinks into your fridge? Our new FlexSpace™ range maximises storage, flexibility and access making it perfect for families.

### value

- Consider which features are most useful to you. Your family's needs may change, so a fridge that can adapt with you is a great option.
- Ongoing running costs can eat into your family budget so check the energy rating system (the more stars and the lower kWh per year the better).

### easy cleaning

- Food can be messy! So you'll benefit from SpillSafe shelves, easy-to-remove parts and fingerprint-resistant surfaces.

### functions & controls

- Manual controls are quick and easy to use
- Electronic controls offer a wider range of clever functions including quick chill, door alarms, quick freeze and holiday mode.

### security & reliability

- A fridge or freezer is a considerable investment so make sure you buy a quality brand you can trust.
- For extra peace-of-mind ensure that the company you choose can provide advice, service and support for your fridge well beyond the shop floor.

### R600a refrigerant

- Westinghouse is committed to caring for the environment. That's why all of our fridges have started converting over to use the less harmful R600a refrigerant. So now your family fridge can quietly play its own part in reducing your household's impact on the environment.



more flex,  
more space.

ORGANISATION SOLUTION

## FlexSpace™

There's a good fridge then there's a great fridge. The Westinghouse FlexSpace range is definitely the latter, specifically designed for households of 1 or 10, we'll fit into your lifestyle. We know you can always do more with the space you've got. With a combination of clever adjustable interiors, our shelves, drawers, crispers and door bins have got you covered.



STYLISH DESIGN

## real steel



Our fridges are available in a dark or natural real stainless steel.\* Creating a stylish new centrepiece in your kitchen that is easy to clean with a fingerprint resistant finish.

\* Selected models.



FRESHSEAL CRISPERS

## superior seals, superior flavour

Whether you're cooking for the family or just yourself, freshness is the king of the kitchen. Our FreshSeal Crispers have advanced seals, and with humidity control you get better flexibility to look after your food the right way. Our seals assist in preventing moisture loss, while the humidity control lets you provide a better environment for fresher tasting food.

A woman with long dark hair, wearing a white sleeveless top and grey pants, is kneeling on a light-colored tiled floor in a kitchen. She is kissing a young child on the cheek. The child is wearing a grey t-shirt and grey pants. The kitchen background features white cabinets, a dark countertop, a sink with a faucet, a wooden cutting board, and various kitchen items. A large blue circle is overlaid on the left side of the image, containing the text.

the kitchen  
is the heart  
and soul of  
every home

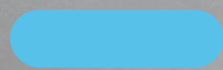

LARGE FRENCH DOOR

## larger than life

Our large French door range can accommodate the ever-growing family and the appetites that come with it. With dual doors opening to reveal a cavernous interior, our large French door fridge with convertible compartment or drawer and FlexSpace has room for the whole family's hungry tummies.







## LARGE FRENCH DOOR

# features

### Flexspace™ fully convertible drawer

With the widest temperature range from -23C to +7C, our FlexSpace™ Fully Convertible Drawer adapts to your needs with the touch of a button\*. With 5 predefined settings you can chill your drinks, freeze your meat or store your deli snacks, taking the headached out of the fridge and freezer shuffle, making you feel really clever.

### Dual freezer storage

With extra freezer space, you can arrange your frozen items in a way that suits your lifestyle. Place the most important items like ice cream in the top drawer and prepared meals when mum's away in the bottom drawer

### Freshseal™ easy glide crispers

The FreshSeal™ crispers with automatic humidity control give you the flexibility to look after your fruit and vegetables the right way. Designed with your comfort in mind, the easy glide crispers bins open effortlessly and provide easy access even when they're full.

### smartsplit door design

Our SmartSplit™ optimally split doors, are not only stylish but help you use the space in your fridge more efficiently. Store larger items on one side, smaller ones on the other and eliminate the need to open both doors every time.

### filtered ice & water dispenser

The built in door dispenser provides fresh, filtered water as well as cubed or crushed ice at the touch of a button.

### slide back and flip up shelves

The flexibility to slide back or flip up some of the fridge shelving makes fitting those extra tall items or large platters a piece of cake

### SnackZone

The SnackZone is the ideal compartment for family favourites. The optimal height for even the smallest family members to reach, ensuring healthy snacks are always available

### dualcooling

With the DualCooling system, the fridge and freezer compartments work independently to maintain the optimum temperature and humidity to keep foods fresh or frozen



\*within 2 hours  
 ^ WQE6870SA & WQE6870BA only  
 † WHE6170BB & WHE6170SB only

RANGE  
large French door



WQE6870BA

**609L french door refrigerator, dark stainless steel with convertible compartment**

- Convertible temperature compartment that converts from fridge to freezer
- Asymmetrical door design for more usable door storage
- Easy glide crispers with automatic humidity control
- Filtered ice and water dispenser
- Slide Back and Flip Up shelves



Overall Fridge dimensions\* (including door):  
1782h x 913w x 749d (mm)

Door is designed to sit proud



WQE6870SA

**609L french door refrigerator, stainless steel with convertible compartment**

- Convertible temperature compartment that converts from fridge to freezer
- Asymmetrical door design for more usable door storage
- Easy glide crispers with automatic humidity control
- Filtered ice and water dispenser
- Slide Back and Flip Up shelves



Overall Fridge dimensions\* (including door):  
82h x 913w x 749d (mm)

Door is designed to sit proud



chill as you choose with the  
**FlexSpace compartment**

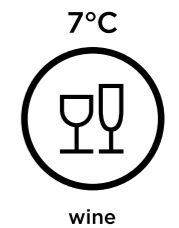

RANGE  
**large French door**



WHE6170BB/WHE6170SB

**609L stainless steel french door fridge with drawer**

- Convertible temperature compartment that converts from fridge to freezer
- Asymmetrical door design for more usable door storage
- FreshSeal™ Easy Glide Humidity Controlled Crispers
- Filtered ice and water dispenser
- Flip up Shelf



Overall Fridge dimensions\* (including door):  
 1782h x 913w x 813d (mm)

Door is designed to sit proud



WHE6270SB

**619L stainless steel french door fridge with drawer**

- Large 248L freezer capacity split between two easy access drawers
- Asymmetrical door design for more storage
- FreshSeal™ Easy Glide Humidity Controlled Crispers
- Filtered ice and water dispenser
- Slide Back and Flip Up shelves



Overall Fridge dimensions\* (including door):  
 1782h x 913w x 813d (mm)

Door is designed to sit proud





SLIM FRENCH DOOR

## Slim in size, packed with features

Our range of fridges pack a lot into their slim French doors. Designed to fit into a 90cm fridge cavity, these fridges come with far more space than meets the eye. This means more fresh food, big grocery shops and a fridge that is always organised. You'll never run low on space, or compartments. With three or four door configurations you can stack like a pro, fitting more of your favourite produce in the fridge you love.

WQE6060BB



SLIM FRENCH DOOR

## features

### slim fridge, to fit in a 90cm space

Designed for maximum storage, our large 600/605L Westinghouse French door fridges are slim enough to fit in a 90cm space with ease.

### contains spills

Spills happen, but when they do, the world doesn't have to end. The Westinghouse Spillsafe glass shelves help with the mess by containing the spilt liquid to one shelf, so you have less to clean.

### filtered water

Designed to quench the needs of even the thirstiest family member, the filtered water dispenser built into the fridge door will eliminate thirst in your household with refreshing convenience. (Selected models)

### always on ice

With the convenience of an automatic ice maker, we've got your ice needs covered. By continuously replenishing itself, you will always have ice available for your family or last minute guests. (Selected models)

### superior seals, superior flavour

Our FreshSeal Crispers have advanced seals, and with humidity control you get better flexibility to look after your food the right way. Our seals assist in preventing moisture loss, while the humidity control lets you provide a better environment for fresher tasting food.

### never fear, our family safe lock is here

Some things picked up on the shop aren't meant to be shared. Keep medication or treats from prying hands with the Westinghouse FamilySafe Lockable Compartment.

### endless possibilities with FlexSpace™

Designed to suit your ever-changing needs, the extra spacious French door design delivers a wider fridge capacity with FlexSpace™. Perfect for party platters or lots of fresh food, you'll love having everything at eye level so you can easily check all the contents with just a glance.

### keeping your fridge looking its spotless best

Life can get messy, that's why we've made our Westinghouse fingerprint resistant real stainless steel easy to clean. Just one quick wipe with a damp cloth and you are mark free again.

RANGE  
**slim French door**



WQE6060BB

**541L french quad door refrigerator, dark stainless steel with in door ice & water dispenser**

- Fits into a 900mm space
- Continuous fresh water & ice maker
- Dual sealed crispers with humidity control
- Adjustable storage solutions
- SpillSafe™ glass shelves



Overall Fridge dimensions\* (including door):  
 1725h x 896w x 781d (mm)

Door is designed to sit proud



WQE6000BB

**541L french door refrigerator, dark stainless steel**

- Fits into a 900mm space
- Dual sealed crispers with humidity control
- Adjustable storage solutions
- SpillSafe™ glass shelves
- Lockable compartment



Overall Fridge dimensions\* (including door):  
 1725h x 896w x 781d (mm)

Door is designed to sit proud



WQE6060SB

**541L french quad door refrigerator, natural stainless steel with in door ice & water dispenser**

- Fits into a 900mm space
- Continuous fresh water & ice maker
- Dual sealed crispers with humidity control
- Adjustable storage solutions
- SpillSafe™ glass shelves



Overall Fridge dimensions\* (including door):  
 1725h x 896w x 781d (mm)

Door is designed to sit proud



WQE6000SB

**541L french door refrigerator, natural stainless steel**

- Fits into a 900mm space
- Dual sealed crispers with humidity control
- Adjustable storage solutions
- SpillSafe™ glass shelves
- Lockable compartment



Overall Fridge dimensions\* (including door):  
 1725h x 896w x 781d (mm)

Door is designed to sit proud

RANGE  
**slim French door**



WHE6060SB

**565L french door refrigerator, natural stainless steel with drawer & in door water dispenser**

- Fits into a 900mm space
- Dual sealed crispers with humidity control
- Continuous fresh water & ice maker
- Adjustable storage solutions
- SpillSafe™ glass shelves



Overall Fridge dimensions\* (including door):  
 1725h x 896w x 781d (mm)

Door is designed to sit proud



WHE6000SB

**565L french door refrigerator, natural stainless steel with drawer**

- Fits into a 900mm space
- Dual sealed crispers with humidity control
- Adjustable storage solutions
- SpillSafe™ glass shelves
- Lockable compartment



Overall Fridge dimensions\* (including door):  
 1725h x 896w x 781d (mm)

Door is designed to sit proud



WHE6060SA



COMPACT FRENCH DOOR

## compact, yet stylish

Loaded with timeless style, our range of compact French door fridges come with flexible interiors giving you more time to create the tasty and nutritious meals for those you love. Available in dark and natural fingerprint-resistant real stainless steel, it's a fridge that's life proof and looks at home in your kitchen.

WHE5204BC





## COMPACT FRENCH DOOR

# features

### stylish design

Crafted with ultra-modern flat doors, elegant handle options and your choice of Dark or Natural Real Stainless Steel your fridge will be the centrepiece of your kitchen. (Options vary by model)

### less energy, more care

Our range has been designed to be energy efficient\*, reducing your electricity usage and so helping you to care for the environment around you. (Energy ratings and running costs vary by model)

\*Designed to meet AS/NZS IEC 62552-3 (L)

### superior seals, superior flavour

Our FreshSeal Crispers have advanced seals, and with humidity control you get better flexibility to look after your food the right way. Our seals assist in preventing moisture loss, while the humidity control lets you provide a better environment for fresher tasting food.

### FlexStor fits your life

When life gets busy, flexibility is a life saver. That's why Westinghouse created the FlexStor system. The adjustable door bins allow for quick and easy adjustment whenever or however you need it. We make it easy to do more with your fridge.

### contains spills

Spills happen, but when they do, the world doesn't have to end. The Westinghouse Spillsafe glass shelves help with the mess by containing the spill liquid to one shelf, so you have less to clean.

### always on ice

With the convenience of an automatic ice maker, we've got your ice needs covered. By continuously replenishing itself, you will always have ice available for your family or last minute guests. (Selected models)

### easy glide runners

You don't know it yet but you'll love our easy glide telescopic runners. They're easy to open and close and when fully extended provide superior access to your frozen foods. No matter how much food you have stored, they'll always run smoothly.

### keeping your fridge looking its spotless best

Life can get messy, that's why we've made our Westinghouse fingerprint resistant real stainless steel easy to clean. Just one quick wipe with a damp cloth and you are mark free again.



RANGE  
compact French door



WHE5204BC

**491L french door refrigerator, dark stainless steel with drawer**

- Stylish flat door design
- Excellent energy efficiency with inverter compressor
- Sealed crisper with humidity control
- Adjustable storage solutions
- SpillSafe™ glass shelves



Overall Fridge dimensions\* (including door):  
1725h x 796w x 769d (mm)  
Door is designed to sit proud



WHE5204SC

**491L french door refrigerator, natural stainless steel with drawer**

- Stylish flat door design
- Excellent energy efficiency with inverter compressor
- Sealed crisper with humidity control
- Adjustable storage solutions
- SpillSafe™ glass shelves



Overall Fridge dimensions\* (including door):  
1725h x 796w x 769d (mm)  
Door is designed to sit proud



WHE5264SC

**491L french door refrigerator, natural stainless steel with freezer drawer & in door water dispenser**

- Stylish flat door design
- Excellent energy efficiency with inverter compressor
- Continuous fresh water & ice maker
- Sealed crisper with humidity control
- Adjustable storage solutions



Overall Fridge dimensions\* (including door):  
1725h x 796w x 769d (mm)  
Door is designed to sit proud

LARGE BOTTOM MOUNT

## packed with flexible features

Whether it's parties, or a cheeky lunch leftover, we have flexible space for everything, combined with a humidity controlled FreshSeal Crisper for longer lasting produce. The freezer, conveniently placed at the bottom, features telescopic runners in the drawers, creating easier access even when full.

WBE4504SC



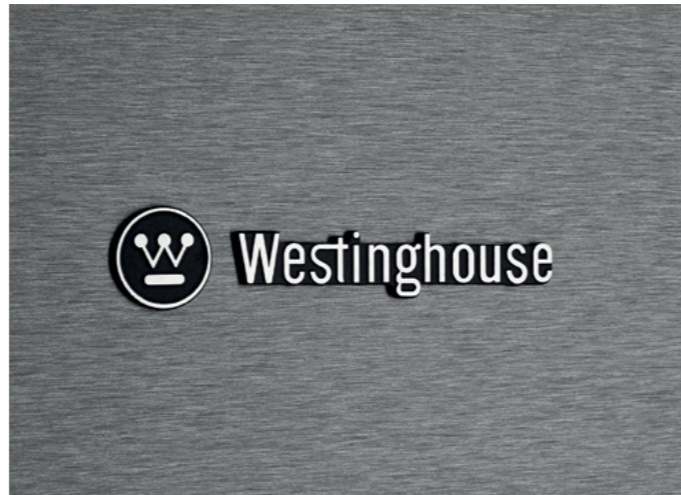

## LARGE BOTTOM MOUNT

### features

#### keep it stylish

Crafted with ultra-modern flat doors, elegant handle options and your choice of Dark or Natural Real Stainless Steel or white your fridge will be the centrepiece of your kitchen. (Options vary by model)

#### contains spills

Spills happen, but when they do, the world doesn't have to end. The Westinghouse Spillsafe glass shelves help with the mess by containing the spilt liquid to one shelf, so you have less to clean.

#### less energy, more care

Our range has been designed to be energy efficient\*, reducing your electricity usage and so helping you to care for the environment around you. (Energy ratings and running costs vary by model)

\*Designed to meet AS/NZS IEC 62552-3 (L)

#### cool down with a twist

Whether it's for an afternoon juice or a whisky on the "rocks", our easy access twist ice dispenser and tray allows you to just twist and serve ice simply.

#### easy glide runners

You don't know it yet but you'll love our easy glide telescopic runners. They're easy to open and close and when fully extended provide superior access to your frozen foods. No matter how much food you have stored, they'll always run smoothly.

#### superior seals, superior flavour

Our FreshSeal Crispers have advanced seals, and with humidity control you get better flexibility to look after your food the right way. Our seals assist in preventing moisture loss, while the humidity control lets you provide a better environment for fresher tasting food.

#### keeping your fridge looking its spotless best

Life can get messy, that's why we've made our Westinghouse fingerprint resistant real stainless steel easy to clean. Just one quick wipe with a damp cloth and you are mark free again.

#### FlexStor fits your life

When life gets busy, flexibility is a life saver. That's why Westinghouse created the FlexStor system. The adjustable door bins allow for quick and easy adjustment whenever or however you need it. We make it easy to do more with your fridge.

RANGE  
**large bottom mount**



WBE4504BC

**425L bottom freezer refrigerator, dark stainless steel with pole handles**

- Stylish flat door design
- Excellent energy efficiency with inverter compressor
- Sealed crisper with humidity control
- Adjustable storage solutions
- SpillSafe™ glass shelves
- Easy glide telescopic freezer drawers



Overall Fridge dimensions\* (including door):  
 1725h x 699w x 769d (mm)

Door is designed to sit proud



WBE4500BC

**425L bottom freezer refrigerator, dark stainless steel**

- Stylish flat door design
- Excellent energy efficiency with inverter compressor
- Sealed crisper with humidity control
- Adjustable storage solutions
- SpillSafe™ glass shelves
- Easy glide telescopic freezer drawers



Overall Fridge dimensions\* (including door):  
 1725h x 699w x 723d (mm)

Door is designed to sit proud



WBE4504SC

**425L bottom freezer refrigerator, natural stainless steel with pole handles**

- Stylish flat door design
- Excellent energy efficiency with inverter compressor
- Sealed crisper with humidity control
- Adjustable storage solutions
- SpillSafe™ glass shelves
- Easy glide telescopic freezer drawers



Overall Fridge dimensions\* (including door):  
 1725h x 699w x 769d (mm)

Door is designed to sit proud

RANGE  
**large bottom mount**

NEW



WBE4302WC

**425L bottom freezer refrigerator, white**

- Full width sealed crisper with manual humidity control
- Adjustable SpillSafe glass shelves
- Twist & Serve icemaker
- Quick Chill Function



Overall Fridge dimensions\*  
 (including door):  
 1725h x 699w x 723d (mm)

Door is designed to sit proud

NEW



WBE4302AC

**425L bottom freezer refrigerator, silver**

- Full width sealed crisper with manual humidity control
- Adjustable SpillSafe glass shelves
- Twist & Serve icemaker
- Quick Chill Function



Overall Fridge dimensions\*  
 (including door):  
 1725h x 699w x 723d (mm)

Door is designed to sit proud

RANGE  
large bottom mount



WBE5300BC

**496L bottom freezer refrigerator, dark stainless steel**

- Stylish flat door design
- Excellent energy efficiency with inverter compressor
- Sealed crisper with humidity control
- Adjustable storage solutions
- SpillSafe™ glass shelves
- Easy glide telescopic freezer drawers



Overall Fridge dimensions\* (including door):  
1725h x 796w x 723d (mm)

Door is designed to sit proud



WBE5300WC

**496L bottom freezer refrigerator, white**

- Stylish flat door design
- Excellent energy efficiency with inverter compressor
- Sealed crisper with humidity control
- Adjustable storage solutions
- SpillSafe™ glass shelves
- Easy glide telescopic freezer drawers



Overall Fridge dimensions\* (including door):  
1725h x 796w x 723d (mm)

Door is designed to sit proud



WBE5300SC

**496L bottom freezer refrigerator, natural stainless steel**

- Stylish flat door design
- Excellent energy efficiency with inverter compressor
- Sealed crisper with humidity control
- Adjustable storage solutions
- SpillSafe™ glass shelves
- Easy glide telescopic freezer drawers



Overall Fridge dimensions\* (including door):  
1725h x 796w x 723d (mm)

Door is designed to sit proud



COMPACT BOTTOM MOUNT

## fit in more of what you love

Compact doesn't always mean sacrificing features or functionality. The Westinghouse Compact Bottom Mount Fridge has the perfect flexibility for your party shop, or your weekly one, fitting in what you need when you need and keeping it fresh.

WBB3700AH





## COMPACT BOTTOM MOUNT

# features

### easy clean glass

Cleaning your fridge shelves has never been easier. The Westinghouse adjustable glass shelving can be easily manoeuvred allowing you to effortlessly get into every nook and cranny, no matter the mess.

### stylish design

The easy clean silver doors ensure our fridges maintain that sleek clean look. In fact, a damp cloth should be all you need to remove fingerprint marks.

### keep your food fresher for longer

Fresher food means tastier food. The Westinghouse Multi-Flow Air Delivery System keeps the temperature stable so every ingredient in the fridge stays fresher for longer.

### easy to use electronic controls

With the Westinghouse Electronic control system, you can easily change the temperature of your fridge with the touch of a button.

### cool down with a twist

Whether it's for an afternoon juice or a whisky on the "rocks", our easy access twist ice dispenser and tray allows you to just twist and serve ice simply.

### see more with LED

Spend less time with your head in the fridge and more time enjoying your fresh food with Westinghouse's LED lighting. More light means you find what you're looking for faster.



RANGE  
compact bottom mount

NEW



WBB3400AK

**335L bottom freezer refrigerator, arctic steel**

- Arctic silver finish
- Full width crisper with manual humidity control
- Twist & Serve icemaker
- Adjustable, easy to clean glass shelves



Overall Fridge dimensions\* (including door):  
1756h x 598w x 650d (mm)

Door is designed to sit proud

NEW



WBB3100AK

**308L bottom freezer refrigerator, arctic steel**

- Arctic silver finish
- Full width crisper with manual humidity control
- Twist & Serve icemaker
- Adjustable, easy to clean glass shelves



Overall Fridge dimensions\* (including door):  
1650h x 598w x 650d (mm)

Door is designed to sit proud

NEW



WBB3400WK

**335L bottom freezer refrigerator, white**

- Full width crisper with manual humidity control
- Twist & Serve icemaker
- Adjustable, easy to clean glass shelves



Overall Fridge dimensions\* (including door):  
1756h x 598w x 650d (mm)

Door is designed to sit proud

NEW



WBB3100WK

**308L bottom freezer refrigerator, white**

- Full width crisper with manual humidity control
- Twist & Serve icemaker
- Adjustable, easy to clean glass shelves



Overall Fridge dimensions\* (including door):  
1650h x 598w x 650d (mm)

Door is designed to sit proud

LARGE TOP MOUNT

## more space for fresh food

The best fridges should have plenty of space for fresh food. Our popular range of Large Top Mount Fridges are designed for exactly that. Featuring FlexSpace interiors which lets you rearrange the height and the positions of your door bins and shelves to suit your ever changing needs.

WTB5400SC





LARGE TOP MOUNT

## features

### keep it stylish

Crafted with ultra-modern flat doors, elegant handle options and your choice of Dark or Natural Real Stainless Steel or white your fridge will be the centrepiece of your kitchen. (Options vary by model)

### contains spills

Spills happen, but when they do, the world doesn't have to end. The Westinghouse Spillsafe glass shelves help with the mess by containing the spilt liquid to one shelf, so you have less to clean.

### less energy, more care

Our range has been designed to be energy efficient\*, reducing your electricity usage and so helping you to care for the environment around you. (Energy ratings and running costs vary by model)

\*Designed to meet AS/NZS IEC 62552-3 (L)

### cool down with a twist

Whether it's for an afternoon juice or a whisky on the "rocks", our easy access twist ice dispenser and tray allows you to just twist and serve ice simply.

### superior seals, superior flavour

Our FreshSeal Crispers have advanced seals, and with humidity control you get better flexibility to look after your food the right way. Our seals assist in preventing moisture loss, while the humidity control lets you provide a better environment for fresher tasting food.

### chilled and organised

Bring the whole deli home with our large organised chiller compartments. Easy to find what you need when you need them so you spend more time creating and less time playing deli detective.

### keeping your fridge looking its spotless best

Life can get messy, that's why we've made our Westinghouse fingerprint resistant real stainless steel easy to clean. Just one quick wipe with a damp cloth and you are mark free again.

### FlexStor fits your life

When life gets busy, flexibility is a life saver. That's why Westinghouse created the FlexStor system. The adjustable door bins allow for quick and easy adjustment whenever or however you need it. We make it easy to do more with your fridge.

RANGE  
**large top mount**



WTB4600SC

**431L top freezer refrigerator, natural stainless steel with FlexStor**

- Stylish flat door design
- Excellent energy efficiency with inverter compressor
- Sealed crisper with humidity control
- Adjustable storage solutions
- SpillSafe™ glass shelves



Overall Fridge dimensions\* (including door):  
 1725h x 699w x 723d (mm)

Door is designed to sit proud



WTB4604SC

**431L top freezer refrigerator, natural stainless steel with FlexStor & pole handles**

- Stylish flat door design
- Excellent energy efficiency with inverter compressor
- Sealed crisper with humidity control
- Adjustable storage solutions
- SpillSafe™ glass shelves



Overall Fridge dimensions\* (including door):  
 1725h x 699w x 769d (mm)

Door is designed to sit proud



WTB4600WC

**431L top freezer refrigerator, white with FlexStor**

- Stylish flat door design
- Excellent energy efficiency with inverter compressor
- Sealed crisper with humidity control
- Adjustable storage solutions
- SpillSafe™ glass shelves
- Lockable compartment



Overall Fridge dimensions\* (including door):  
 1725h x 699w x 723d (mm)

Door is designed to sit proud

RANGE  
**large top mount**



WTB5400SC

**503L top freezer refrigerator, natural stainless steel with FlexStor**

- Stylish flat door design
- Excellent energy efficiency with inverter compressor
- Sealed crisper with humidity control
- Adjustable storage solutions
- SpillSafe™ glass shelves



Overall Fridge dimensions\* (including door):  
 1725h x 796w x 723d (mm)

Door is designed to sit proud



WTB5404SC

**503L top freezer refrigerator, natural stainless steel with FlexStor & pole handles**

- Stylish flat door design
- Excellent energy efficiency with inverter compressor
- Sealed crisper with humidity control
- Adjustable storage solutions
- SpillSafe™ glass shelves



Overall Fridge dimensions\* (including door):  
 1725h x 796w x 769d (mm)

Door is designed to sit proud



WTB5400WC

**503L top freezer refrigerator, white with FlexStor**

- Stylish flat door design
- Excellent energy efficiency with inverter compressor
- Sealed crisper with humidity control
- Adjustable storage solutions
- SpillSafe™ glass shelves
- Lockable compartment



Overall Fridge dimensions\* (including door):  
 1725h x 796w x 723d (mm)

Door is designed to sit proud



COMPACT TOP MOUNT

## compact outside, big inside

Sometimes your fridge needs to be clever, compact and stylish but this doesn't mean it can't fit a lot in. At Westinghouse, we've done a great deal with small spaces, creating flexible features which maximise the effectiveness of the available space.

WTB2800AH



COMPACT TOP MOUNT

## features

### FlexStor fits your life

When life gets busy, flexibility is a life saver. That's why Westinghouse created the FlexStor system. The adjustable door bins allow for quick and easy adjustment whenever or however you need it. We make it easy to do more with your fridge.

### keep your food fresher for longer

Fresher food means tastier food. The Westinghouse Multi-Flow Air Delivery System keeps the temperature stable so every ingredient in the fridge stays fresher for longer.

### chilled and organised

Bring the whole deli home with our large organised chiller compartments. Easy to find what you need when you need them so you spend more time creating and less time playing deli detective.

### easy to use electronic controls

With the Westinghouse Electronic control system, you can easily change the temperature of your fridge with the touch of a button.

### easy clean silver doors

The easy clean silver doors ensure our fridges maintain that sleek clean look. In fact, a damp cloth should be all you need to remove fingerprint marks.

### cool down with a twist

Whether it's for an afternoon juice or a whisky on the "rocks", our easy access twist ice dispenser and tray allows you to just twist and serve ice simply.

### easy clean glass

Cleaning your fridge shelves has never been easier. The Westinghouse adjustable glass shelving can be easily manoeuvred allowing you to effortlessly get into every nook and cranny, no matter the mess.





RANGE  
compact top mount

NEW



WTB3400AK

**341L top freezer refrigerator, arctic steel**

- Arctic silver finish
- Full width sealed crisper
- Twist & serve icemaker
- Adjustable, easy to clean glass shelves



Overall Fridge dimensions\* (including door):  
1756h x 598w x 650d (mm)

Door is designed to sit proud

NEW



WTB3100AK

**312L top freezer refrigerator, arctic steel**

- Arctic silver finish
- Full width sealed crisper
- Twist & serve icemaker
- Adjustable, easy to clean glass shelves



Overall Fridge dimensions\* (including door):  
1650h x 598w x 650d (mm)

Door is designed to sit proud

NEW



WTB3400WK

**341L top freezer refrigerator, white**

- Full width sealed crisper
- Twist & serve icemaker
- Adjustable, easy to clean glass shelves



Overall Fridge dimensions\* (including door):  
1756h x 598w x 650d (mm)

Door is designed to sit proud

NEW



WTB3100WK

**312L top freezer refrigerator, white**

- Full width sealed crisper
- Twist & serve icemaker
- Adjustable, easy to clean glass shelves



Overall Fridge dimensions\* (including door):  
1650h x 598w x 650d (mm)

Door is designed to sit proud

RANGE  
compact top mount



WTB2800AH

**256L top freezer refrigerator, arctic steel with FlexStor**

- Adjustable storage solutions with FlexStor™
- Full width manual humidity controlled crisper
- Twist ice & serve
- Easy clean glass shelves
- Chiller compartment



Overall Fridge dimensions\* (including door):  
1605h x 540w x 615d (mm)

Door is designed to sit proud



WTB2500WH

**225L top freezer refrigerator, white with FlexStor**

- Adjustable storage solutions with FlexStor™
- Easy clean glass shelves
- Full width manual humidity controlled crisper
- Twist ice and serve
- Chiller compartment



Overall Fridge dimensions\* (including door):  
1470h x 540w x 615d (mm)

Door is designed to sit proud



WTB2800WH

**256L top freezer refrigerator, white with FlexStor**

- Adjustable storage solutions with FlexStor™
- Full width manual humidity controlled crisper
- Twist ice & serve
- Easy clean glass shelves
- Chiller compartment



Overall Fridge dimensions\* (including door):  
1605h x 540w x 615d (mm)

Door is designed to sit proud



WTB2300WH

**211L top freezer refrigerator, white with FlexStor**

- Adjustable storage solutions with FlexStor™
- Easy clean glass shelves
- Full width manual humidity controlled crisper
- Twist ice and serve
- Chiller compartment



Overall Fridge dimensions\* (including door):  
1405h x 540w x 615d (mm)

Door is designed to sit proud

SIDE BY SIDES

## fridge and freezer side by side

With the convenience of a full height fridge and freezer in a single unit, our side by sides offer large capacity with ease of access. With the combination of shelves, drawers and door bins on both sides you can take your organisation skills to the next level.





SIDE BY SIDES

## features



### filtered water dispenser

Designed to quench the needs of even the thirstiest family member, the non plumbed filtered water dispenser built into the fridge door will eliminate thirst in your household with refreshing convenience (selected models)

### cool down with a twist

Whether it's for an afternoon juice or a whisky on the "rocks", our easy access twist ice dispenser and tray allows you to just twist and serve ice simply. (Selected models)



### adjustable interiors with SpillSafe glass shelves

With over 20 different shelving and door bin positions, you can easily fit the smallest deli items to the biggest party platters. SpillSafe glass shelves improve visibility and isolate leaks - preventing up to 1 litre of spills from dripping down to the shelves below.

### see more with LED

Spend less time with your head in the fridge and more time enjoying your fresh food with Westinghouse's LED lighting. More light means you find what you're looking for faster. (Selected models)



### chill out with Quick Freeze

Quick Freeze lowers the temperature of your freezer down fast to start the freezing process.

### cool your groceries fast

Activate the Quick Chill function to cool your groceries, keeping them fresher for longer



RANGE  
side by sides

NEW



WSE6630SA

**624L side by side refrigerator, silver**

- Dual twist & serve icemakers
- Dual crispers
- SpillSafe glass shelves
- Quick Chill & Quick Freeze
- Energy saving holiday mode



Overall Fridge dimensions\* (including door):  
1780H x 911W x 746D (mm)

Door is designed to sit proud

NEW



WSE6640BA

**619L side by side refrigerator, dark with non plumbed water dispenser**

- Non plumbed water dispenser
- Dual twist & serve icemakers
- Dual crispers
- SpillSafe glass shelves
- Quick Chill & Quick Freeze
- Energy saving holiday mode



Overall Fridge dimensions\* (including door):  
1780H x 911W x 746D (mm)

Door is designed to sit proud

NEW



WSE6630WA

**624L side by side refrigerator, white**

- Dual twist & serve icemakers
- Dual crispers
- SpillSafe glass shelves
- Quick Chill & Quick Freeze
- Energy saving holiday mode



Overall Fridge dimensions\* (including door):  
1780H x 911W x 746D (mm)

Door is designed to sit proud





SINGLE DOOR FRIDGES  
AND VERTICAL FREEZERS

## double the convenience

Westinghouse's single door fridges and vertical freezers can be combined to give you two units in one big space, providing you with maximum fresh food and freezer storage. Or they can be placed in separate places to give you the best utilisation of space in your kitchen.

WRB5004SC



## SINGLE DOOR FRIDGES AND VERTICAL FREEZERS

### features

#### keep it stylish

Crafted with ultra-modern flat doors, elegant handles and your choice of real stainless steel or white, your fridge will be the centrepiece of your kitchen. (Selected models)

#### less energy, more care

Our range has been designed to be energy efficient\*, reducing your electricity usage and so helping you to care for the environment around you. (Energy ratings and running costs vary by model)

\*Designed to meet AS/NZS IEC 62552-3 (L)

#### contains spills

Spills happen, but when they do, the world doesn't have to end. The Westinghouse Spillsafe glass shelves help with the mess by containing the spilt liquid to one shelf, so you have less to clean.

#### FlexStor fits your life

When life gets busy, flexibility is a life saver. That's why Westinghouse created the FlexStor system. The adjustable door bins allow for quick and easy adjustment whenever or however you need it. We make it easy to do more with your fridge.

#### pigeon pair

Place your single door fridge and vertical freezer together in one space to create the maximum fresh storage for your big family.

#### cool down with a twist

Whether it's for an afternoon juice or a whisky on the "rocks", our easy access twist ice dispenser and tray allows you to just twist and serve ice simply.

#### see more with LED

Spend less time with your head in the fridge and more time enjoying your fresh food with Westinghouse's LED lighting. More light means you find what you're looking for faster.

#### keeping your fridge looking its spotless best

Life can get messy, that's why we've made our Westinghouse fingerprint resistant real stainless steel easy to clean. Just one quick wipe with a damp cloth and you are mark free again. (Selected models)





RANGE  
single door fridges



WRB5004SC

**466L single door refrigerator, natural stainless steel with FlexStor™**

- Stylish flat door design
- Excellent energy efficiency with inverter compressor
- Sealed crisper with humidity control
- Adjustable storage solutions SpillSafe™ glass shelves
- Fingerprint resistant real stainless steel



Overall Fridge dimensions\* (including door):  
1725h x 699w x 769d (mm)

Door is designed to sit proud



WRB3504SA

**328L single door refrigerator, natural stainless steel with FlexStor**

- Fingerprint resistant stainless steel
- Adjustable storage solutions with FlexStor™
- Combine with WFB2804SA for a pigeon pair
- SpillSafe™ glass shelves
- Quick chill function



Overall Fridge dimensions\* (including door):  
1746h x 595w x 700d (mm)

Door is designed to sit proud



WRB5004WC

**466L single door refrigerator, white with FlexStor™**

- Stylish flat door design
- Excellent energy efficiency with inverter compressor
- Sealed crisper with humidity control
- Adjustable storage solutions
- SpillSafe™ glass shelves
- Lockable compartment



Overall Fridge dimensions\* (including door):  
1725h x 699w x 769d (mm)

Door is designed to sit proud



WRB3504WA

**328L single door refrigerator, white with FlexStor**

- Adjustable storage solutions with FlexStor™
- Combine with WFB2804SA for a pigeon pair
- SpillSafe™ glass shelves
- Electronic touch controls
- Quick chill function



Overall Fridge dimensions\* (including door):  
1746h x 595w x 700d (mm)

Door is designed to sit proud

RANGE  
**single door fridges**



WRM2400WE

**242L single door refrigerator, white**

- Combine with WFM1700WE for a pigeon pair
- Reversible door
- 4 tempered glass shelves
- 4 full-width door bins
- LED fridge light
- Egg tray



**Overall Fridge dimensions\*  
(including door):  
1434h x 550w x 545d (mm)**

Door is designed to sit proud

RANGE  
vertical freezers



WFB4204SC

**388L single door freezer, stainless steel**

- Stylish flat door design
- Excellent energy efficiency with inverter compressor
- 3 full width freezer baskets
- 4 SpillSafe™ glass shelves
- Quick freeze function
- Twist ice and serve



Overall Freezer dimensions\* (including door):  
1725h x 699w x 769d (mm)

Door is designed to sit proud

RANGE  
vertical freezers



WFB2804SA

**254L single door freezer, stainless steel**

- Fingerprint resistant stainless steel
- Combine with WRB3504SA for a pigeon pair
- Twist ice and serve
- 6 full width freezer baskets
- Quick freeze function



Overall Freezer dimensions\* (including door):  
1746h x 595w x 700d (mm)

Door is designed to sit proud



WFB4204WC

**388L single door freezer, white**

- Stylish flat door design
- Excellent energy efficiency with inverter compressor
- 3 full width freezer baskets
- 4 SpillSafe™ glass shelves
- Quick freeze function
- Twist ice and serve
- LED lighting



Overall Freezer dimensions\* (including door):  
1725h x 699w x 769d (mm)

Door is designed to sit proud



WFB2804WA

**254L single door freezer, white**

- Combine with WRB3504WA for a pigeon pair
- Twist ice and serve
- 6 full width freezer baskets
- Electronic touch controls
- Quick freeze function



Overall Freezer dimensions\* (including door):  
1746h x 595w x 700d (mm)

Door is designed to sit proud

RANGE  
**vertical freezers**



WFM1700WE

**155L single door  
freezer, white**

- Combine with WRM2400WE for a pigeon pair
- Frost free
- Reversible doors
- 4 full-width freezer drawers
- Electronic control
- Door alarm



**Overall Freezer dimensions\*  
(including door):  
1434h x 550w x 560d (mm)**

Door is designed to sit proud



FLEXSPACE

## accessories

Westinghouse have designed a collection of clever accessories to complement your FlexSpace™ refrigerator. Choose one or add the whole collection to create the ultimately practical fridge interior to suit your family's needs.

### FlexSpace™ bottle stop

ACC083

Stop your bottles of drink from rolling around the bottom shelf with the bottle lock. With its spring loaded design, the bottle stop allows you to safely lock your bottles into place above the crisper.

### FlexSpace™ 70cm & 80cm pull-out shelves

ACC169/170

The pull-out shelf allows you to conveniently store and access those large and awkward items you would otherwise have trouble placing on your fridge shelf.

### FlexStor small items bins

ACC084

Take advantage of the small spaces on your fridge door with the 2 small items bins. The narrow design allows you to conveniently store those small items that would otherwise get lost in your fridge.

### FlexStor can dispenser

ACC082

The ultimate in chilled convenience. The FlexStor can dispenser allows you to quickly grab a chilled can of drink right from inside the door on your fridge.



INTEGRATION KIT

## seamless integration

The Westinghouse Integrated Refrigeration Kit offers a simple and precise solution for a seamless kitchen. The specialised Westinghouse hinges also allow the fridge door to open to a wide 120°, making it easier to access food as well as clean and remove shelves. In order to prevent unnecessary running around and hidden costs, our unique kit comes complete with all parts to complete the installation, including the hinges.

### How does it work?

The kit is designed to fit our compact top and bottom Westinghouse fridges. It utilises a sliding system which fixes the outer door of the fridge to the kitchen cabinet.

When the cabinet door is opened, the connecting rail opens the fridge in one smooth and simple motion.

### IK010 APPLICABLE MODELS

| top mount | bottom mount |
|-----------|--------------|
| WTB3700   | WBB3700      |
| WTB3400   | WBB3400      |
| WTB2800   | WBB3100      |
| WTB2500   |              |
| WTB2300   |              |
| WTB3100   |              |



specifications



## Large French door

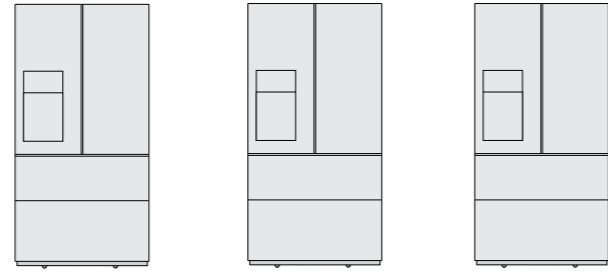

WHE6170BB    WHE6170SB    WHE6270SB

### Features†

|  |                    |                    |                    |
|--|--------------------|--------------------|--------------------|
| capacity (litres)  | 609                | 609                | 619                |
| food compartment capacity (litres)                             | 371                | 371                | 371                |
| freezer compartment capacity (litres)                          | 165                | 165                | 248                |
| Convertible Compartment/Drawer capacity (litres)               | 73                 | 73                 |                    |
| overall dimensions* H x W X D (mm) (including door)            | 1782 x 913 x 803   | 1782 x 913 x 803   | 1782 x 913 x 803   |
| mark resistant real stainless steel door finish                | ✓                  | ✓                  | ✓                  |
| mark resistant dark real stainless steel door finish           | ✓                  | ✓                  | ✓                  |
| energy star rating   | 3.5                | 3.5                | 3.5                |
| energy consumption (kWh/year)                                  | 485                | 485                | 497                |
| frost-free   | ✓                  | ✓                  | ✓                  |
| DualCooling system   | ✓                  | ✓                  | ✓                  |
| electronic temperature controls                                | ✓                  | ✓                  | ✓                  |
| separate temperature controls for fridge and freezer           | ✓                  | ✓                  | ✓                  |
| quick chill function   | ✓                  | ✓                  | ✓                  |
| quick freeze function  | ✓                  | ✓                  | ✓                  |
| holiday mode   | ✓                  | ✓                  | ✓                  |
| door alarm   | fridge and freezer | fridge and freezer | fridge and freezer |
| <b>fridge features</b>   |                    |                    |                    |
| filtered ice and water dispenser                               | ✓                  | ✓                  | ✓                  |
| adjustable SpillSafe glass shelves                             | 2                  | 2                  | 2                  |
| flip up shelf  | 1                  | 1                  | 1                  |
| slide away shelf   | 1                  | 1                  | 1                  |
| FreshSeal automatic humidity controlled crispers               | 2                  | 2                  | 2                  |
| easy glide crispers  | ✓                  | ✓                  | ✓                  |
| SnackZone  | 2                  | 2                  | 2                  |
| egg tray   | 1                  | 1                  | 1                  |
| deep bottle bins   | 1                  | 1                  | 1                  |
| expandable door bins   | 1                  | 1                  | 1                  |
| dairy compartment with lid (in door)                           | 1                  | 1                  | 1                  |
| standard door bins   | 2                  | 2                  | 2                  |
| shallow door bins  | 2                  | 2                  | 2                  |
| interior lighting  | LED                | LED                | LED                |
| <b>middle drawer features</b>                                  |                    |                    |                    |
| function   | fridge and freezer | fridge and freezer | freezer            |
| convertible drawer   | convertible drawer | convertible drawer |                    |
| preset temperature settings                                    | 5                  | 5                  | 1                  |
| freezer (converts to bottom freezer temperature) -23°C / -15°C | ✓                  | ✓                  |                    |
| Ultra Chill -2°C   | ✓                  | ✓                  |                    |
| cold drinks 0°C  | ✓                  | ✓                  |                    |
| deli snacks 3°C  | ✓                  | ✓                  |                    |
| wine and champagne 7°C   | ✓                  | ✓                  |                    |
| drawer divider   | ✓                  | ✓                  | ✓                  |
| <b>freezer features</b>  |                    |                    |                    |
| automatic ice maker  | ✓                  | ✓                  | ✓                  |
| twist and serve ice  |                    |                    |                    |
| ice cube storage bin   |                    |                    |                    |
| ice cube tray  |                    |                    |                    |
| full width freezer drawers                                     | 1                  | 1                  | 1                  |
| full width basket with divider                                 | 1                  | 1                  | 1                  |
| freezer basket runner system                                   | telescopic         | telescopic         | telescopic         |
| freezer light  | LED                | LED                | LED                |
| <b>other features</b>  |                    |                    |                    |
| R600a refrigerant  | ✓                  | ✓                  | ✓                  |
| hidden hinges  | ✓                  | ✓                  | ✓                  |
| front adjustable levelling feet                                | ✓                  | ✓                  | ✓                  |
| rear rollers   | ✓                  | ✓                  | ✓                  |
| water filter accessory   | ULX220 / ACC208    | ULX220 / ACC208    | ULX220 / ACC208    |

\* Overall dimensions include the door and handle. Refer to the dimensions sheet (on page 110 of the brochure) for more details.

† Refer to the product information on the back page of this brochure.

## Large French door

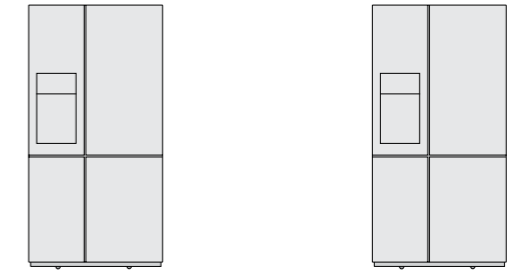

WQE6870BA    WQE6870SA

### Features†

|   |                         |                         |
|---|-------------------------|-------------------------|
| capacity (litres)   | 609                     | 609                     |
| food compartment capacity (litres)                                  | 371                     | 371                     |
| freezer compartment capacity (litres)                               | 147                     | 147                     |
| convertible compartment (litres)                                    | 91                      | 91                      |
| overall dimensions* H x W X D (mm) (including door)                 | 1782 x 913 x 749        | 1782 x 913 x 749        |
| mark resistant real stainless steel door finish                     | ✓                       | ✓                       |
| mark resistant dark real stainless steel door finish                | ✓                       | ✓                       |
| energy star rating  | 3.5                     | 3.5                     |
| energy consumption (kWh/year)                                       | 501                     | 501                     |
| frost-free  | ✓                       | ✓                       |
| DualCooling system  | ✓                       | ✓                       |
| electronic temperature controls                                     | ✓                       | ✓                       |
| separate temperature controls for fridge and freezer                | ✓                       | ✓                       |
| quick chill function  | ✓                       | ✓                       |
| quick freeze function   | ✓                       | ✓                       |
| holiday mode  | ✓                       | ✓                       |
| door alarm  | fridge and freezer      | fridge and freezer      |
| <b>fridge features</b>  |                         |                         |
| filtered ice and water dispenser                                    | ✓                       | ✓                       |
| adjustable SpillSafe glass shelves                                  | 2                       | 2                       |
| flip up shelf   | 1                       | 1                       |
| slide away shelf  | 1                       | 1                       |
| FreshSeal automatic humidity controlled crispers                    | 2                       | 2                       |
| easy glide crispers   | ✓                       | ✓                       |
| SnackZone   | 2                       | 2                       |
| egg tray  | 1                       | 1                       |
| deep bottle bins  | 1                       | 1                       |
| expandable door bins  | 1                       | 1                       |
| dairy compartment with lid (in door)                                | 1                       | 1                       |
| standard door bins  | 2                       | 2                       |
| shallow door bins   | 2                       | 2                       |
| interior lighting   | LED                     | LED                     |
| <b>lower left hand compartment features</b>                         |                         |                         |
| function  | convertible compartment | convertible compartment |
| convertible compartment   | ✓                       | ✓                       |
| preset temperature settings   | 5                       | 5                       |
| freezer (converts to lower right freezer temperature) -23°C / -15°C | ✓                       | ✓                       |
| Ultra Chill -2°C  | ✓                       | ✓                       |
| cold drinks 0°C   | ✓                       | ✓                       |
| deli snacks 3°C   | ✓                       | ✓                       |
| wine and champagne 7°C  | ✓                       | ✓                       |
| Sliding shelf with wine rack  | 2                       | 2                       |
| Sliding drawer  | 2                       | 2                       |
| Standard door bins  | 2                       | 2                       |
| <b>freezer features</b>   |                         |                         |
| automatic ice maker   | ✓                       | ✓                       |
| Sliding shelf   | 2                       | 2                       |
| Sliding drawer  | 2                       | 2                       |
| Standard door bins  | 2                       | 2                       |
| freezer light   | LED                     | LED                     |
| <b>other features</b>   |                         |                         |
| R600a refrigerant   | ✓                       | ✓                       |
| hidden hinges   | ✓                       | ✓                       |
| front adjustable levelling feet                                     | ✓                       | ✓                       |
| rear rollers  | ✓                       | ✓                       |
| water filter accessory  | ULX220 / ACC208         | ULX220 / ACC208         |

\* Overall dimensions include the door and handle. Refer to the dimensions sheet (on page 110 of the brochure) for more details.

† Refer to the product information on the back page of this brochure.



## Slim French door

designed to fit a 90cm cavity

### Features†

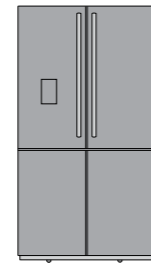

WQE6060BB

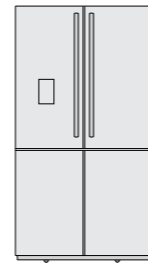

WQE6060SB

|  |                  |                  |
|--|------------------|------------------|
| capacity (litres)                                    | 541              | 541              |
| food compartment capacity (litres)                   | 398              | 398              |
| freezer compartment capacity (litres)                | 143              | 143              |
| overall dimensions* H x W X D (mm) (including door)  | 1725 x 896 x 781 | 1725 x 896 x 781 |
| mark resistant real stainless steel door finish      |                  | ✓                |
| mark resistant dark real stainless steel door finish | ✓                |                  |
| energy star rating                                   | 4                | 4                |
| energy consumption (kWh/year)                        | 382              | 382              |
| frost-free   | ✓                | ✓                |
| multi-flow air delivery system                       | ✓                | ✓                |
| electronic temperature controls                      | ✓                | ✓                |
| separate temperature controls for fridge and freezer | ✓                | ✓                |
| quick freeze function                                | ✓                | ✓                |
| drink chill timer & alarm                            | ✓                | ✓                |
| holiday mode   | ✓                | ✓                |
| door alarm   | fridge & freezer | fridge & freezer |
| <b>fridge features</b>                               |                  |                  |
| filtered water dispenser                             | ✓                | ✓                |
| adjustable SpillSafe glass shelves                   | 3                | 3                |
| FreshSeal sealed humidity controlled crispers        | ✓                | ✓                |
| FamilySafe lockable compartment                      | ✓                | ✓                |
| bottle rack  | ✓                | ✓                |
| egg tray   | ✓                | ✓                |
| bottle bins with retaining fingers                   | 2                | 2                |
| deep door bins                                       | 2                | 2                |
| shallow door bins                                    | 3                | 3                |
| interior lighting                                    | LED              | LED              |
| feature lighting                                     | blue LED         | blue LED         |
| <b>freezer features</b>                              |                  |                  |
| automatic icemaker                                   | plumbed          | plumbed          |
| twist ice and serve                                  |                  |                  |
| ice cube storage bin                                 | ✓                | ✓                |
| self-close main freezer drawer                       |                  |                  |
| freezer basket/drawer runner system                  | suspended        | suspended        |
| full width freezer basket                            |                  |                  |
| 3/4 width freezer drawer                             |                  |                  |
| full width freezer storage bin                       | 3                | 3                |
| full width deep freezer storage bin                  | 2                | 2                |
| half width freezer storage bin                       | 1                | 1                |
| <b>other features</b>                                |                  |                  |
| R600a refrigerant                                    | ✓                | ✓                |
| hidden hinges  | ✓                | ✓                |
| adjustable front rollers                             | ✓                | ✓                |
| rear rollers   | ✓                | ✓                |
| water filter accessory                               | ULX220           | ULX220           |

\* Overall dimensions include the door and handle. Refer to the dimensions sheet (on page 110 of the brochure) for more details.

† Refer to the product information on the back page of this brochure.

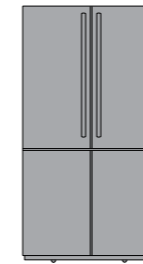

WQE6000BB

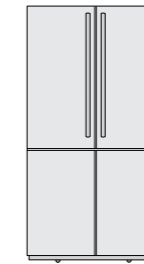

WQE6000SB

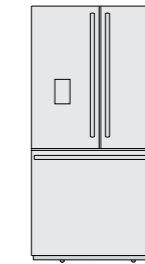

WHE6060SB

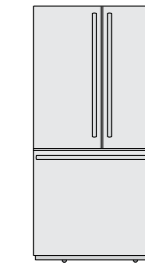

WHE6000SB

|  |                  |                  |                  |                  |
|--|------------------|------------------|------------------|------------------|
| capacity (litres)                                    | 541              | 541              | 565              | 565              |
| food compartment capacity (litres)                   | 398              | 398              | 398              | 398              |
| freezer compartment capacity (litres)                | 143              | 143              | 167              | 167              |
| overall dimensions* H x W X D (mm) (including door)  | 1725 x 896 x 781 | 1725 x 896 x 781 | 1725 x 896 x 781 | 1725 x 896 x 781 |
| mark resistant real stainless steel door finish      |                  | ✓                | ✓                | ✓                |
| mark resistant dark real stainless steel door finish | ✓                |                  |                  |                  |
| energy star rating                                   | 4                | 4                | 4                | 4                |
| energy consumption (kWh/year)                        | 382              | 382              | 382              | 382              |
| frost-free   | ✓                | ✓                | ✓                | ✓                |
| multi-flow air delivery system                       | ✓                | ✓                | ✓                | ✓                |
| electronic temperature controls                      | ✓                | ✓                | ✓                | ✓                |
| separate temperature controls for fridge and freezer | ✓                | ✓                | ✓                | ✓                |
| quick freeze function                                | ✓                | ✓                | ✓                | ✓                |
| drink chill timer & alarm                            |                  |                  | ✓                |                  |
| holiday mode   |                  |                  | ✓                |                  |
| door alarm   | fridge           | fridge           | fridge & freezer | fridge           |
| <b>fridge features</b>                               |                  |                  |                  |                  |
| filtered water dispenser                             |                  |                  | ✓                |                  |
| adjustable SpillSafe glass shelves                   | 3                | 3                | 3                | 3                |
| FreshSeal sealed humidity controlled crispers        | ✓                | ✓                | ✓                | ✓                |
| FamilySafe lockable compartment                      | ✓                | ✓                | ✓                | ✓                |
| bottle rack  | ✓                | ✓                | ✓                | ✓                |
| egg tray   | ✓                | ✓                | ✓                | ✓                |
| bottle bins with retaining fingers                   | 2                | 2                | 2                | 2                |
| deep door bins                                       | 2                | 2                | 2                | 2                |
| shallow door bins                                    | 3                | 3                | 3                | 3                |
| interior lighting                                    | LED              | LED              | LED              | LED              |
| feature lighting                                     | blue LED         | blue LED         | blue LED         | blue LED         |
| <b>freezer features</b>                              |                  |                  |                  |                  |
| automatic icemaker                                   |                  |                  | plumbed          |                  |
| twist ice and serve                                  | ✓                | ✓                |                  | ✓                |
| ice cube storage bin                                 | ✓                | ✓                | ✓                | ✓                |
| self-close main freezer drawer                       |                  |                  | ✓                | ✓                |
| freezer basket/drawer runner system                  | suspended        | suspended        | telescopic       | telescopic       |
| full width freezer basket                            |                  |                  | 1                | 1                |
| 3/4 width freezer drawer                             |                  |                  | 1                | 1                |
| full width freezer storage bin                       | 3                | 3                |                  |                  |
| full width deep freezer storage bin                  | 2                | 2                |                  |                  |
| half width freezer storage bin                       | 1                | 1                |                  |                  |
| <b>other features</b>                                |                  |                  |                  |                  |
| R600a refrigerant                                    | ✓                | ✓                | ✓                | ✓                |
| hidden hinges  | ✓                | ✓                | ✓                | ✓                |
| adjustable front rollers                             | ✓                | ✓                | ✓                | ✓                |
| rear rollers   | ✓                | ✓                | ✓                | ✓                |
| water filter accessory                               |                  |                  | ULX220           |                  |

\* Overall dimensions include the door and handle. Refer to the dimensions sheet (on page 110 of the brochure) for more details.

† Refer to the product information on the back page of this brochure.

# Compact French door

## Features†

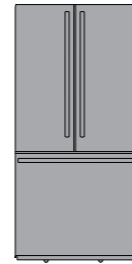

WHE5204BC

|  |                  |
|--|------------------|
| capacity (litres)                                    | 491              |
| food compartment capacity (litres)                   | 345              |
| freezer compartment capacity (litres)                | 146              |
| overall dimensions* H x W X D (mm) (including door)  | 1725 x 796 x 769 |
| mark resistant real stainless steel door finish      |                  |
| mark resistant dark real stainless steel door finish | ✓                |
| stylish flat door design                             | ✓                |
| energy star rating                                   | 4                |
| energy consumption (kWh/year)                        | 363              |
| inverter compressor motor                            | ✓                |
| frost-free   | ✓                |
| multi-flow air delivery system                       | ✓                |
| electronic temperature controls                      | ✓                |
| separate temperature controls for fridge and freezer | ✓                |
| quick freeze function                                | ✓                |
| drink chill timer & alarm                            |                  |
| holiday mode   |                  |
| door alarm   | fridge           |
| <b>fridge features</b>                               |                  |
| filtered water dispenser                             |                  |
| adjustable SpillSafe glass shelves                   | 3                |
| FreshSeal humidity controlled crisper                | ✓                |
| FamilySafe lockable compartment                      | ✓                |
| egg tray   | ✓                |
| bottle bins with retaining fingers                   | 2                |
| deep door bins                                       | 2                |
| shallow door bins                                    | 3                |
| interior lighting                                    | LED              |
| feature lighting                                     | blue LED         |
| <b>freezer features</b>                              |                  |
| automatic icemaker                                   |                  |
| twist ice and serve                                  | ✓                |
| ice cube storage bin                                 | ✓                |
| self-close main freezer drawer                       | ✓                |
| freezer basket/drawer runner system                  | telescopic       |
| large freezer basket                                 | 1                |
| freezer drawer full width                            | 1                |
| freezer drawer 3/4 width                             | 1                |
| <b>other features</b>                                |                  |
| R600a refrigerant                                    | ✓                |
| hidden hinges  | ✓                |
| adjustable front rollers                             | ✓                |
| rear rollers   | ✓                |
| water filter accessory                               |                  |

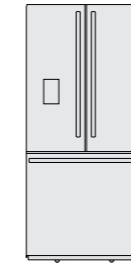

WHE5264SC

|  |                  |                  |
|--|------------------|------------------|
| capacity (litres)                                    | 491              | 491              |
| food compartment capacity (litres)                   | 345              | 345              |
| freezer compartment capacity (litres)                | 146              | 146              |
| overall dimensions* H x W X D (mm) (including door)  | 1725 x 796 x 769 | 1725 x 796 x 769 |
| mark resistant real stainless steel door finish      | ✓                | ✓                |
| mark resistant dark real stainless steel door finish |                  |                  |
| stylish flat door design                             | ✓                | ✓                |
| energy star rating                                   | 4                | 4                |
| energy consumption (kWh/year)                        | 363              | 363              |
| inverter compressor motor                            | ✓                | ✓                |
| frost-free   | ✓                | ✓                |
| multi-flow air delivery system                       | ✓                | ✓                |
| electronic temperature controls                      | ✓                | ✓                |
| separate temperature controls for fridge and freezer | ✓                | ✓                |
| quick freeze function                                | ✓                | ✓                |
| drink chill timer & alarm                            | ✓                |                  |
| holiday mode   | ✓                |                  |
| door alarm   | fridge & freezer | fridge           |
| <b>fridge features</b>                               |                  |                  |
| filtered water dispenser                             | ✓                |                  |
| adjustable SpillSafe glass shelves                   | 3                | 3                |
| FreshSeal humidity controlled crisper                | ✓                | ✓                |
| FamilySafe lockable compartment                      | ✓                | ✓                |
| egg tray   | ✓                | ✓                |
| bottle bins with retaining fingers                   | 2                | 2                |
| deep door bins                                       | 2                | 2                |
| shallow door bins                                    | 3                | 3                |
| interior lighting                                    | LED              | LED              |
| feature lighting                                     | blue LED         | blue LED         |
| <b>freezer features</b>                              |                  |                  |
| automatic icemaker                                   |                  |                  |
| twist ice and serve                                  |                  | ✓                |
| ice cube storage bin                                 | ✓                | ✓                |
| self-close main freezer drawer                       | ✓                | ✓                |
| freezer basket/drawer runner system                  | telescopic       | telescopic       |
| large freezer basket                                 | 1                | 1                |
| freezer drawer full width                            | 1                | 1                |
| freezer drawer 3/4 width                             | 1                | 1                |
| <b>other features</b>                                |                  |                  |
| R600a refrigerant                                    | ✓                | ✓                |
| hidden hinges  | ✓                | ✓                |
| adjustable front rollers                             | ✓                | ✓                |
| rear rollers   | ✓                | ✓                |
| water filter accessory                               | ULX220           |                  |

\* Overall dimensions include the door and handle. Refer to the dimensions sheet (on page 110 of the brochure) for more details.

† Refer to the product information on the back page of this brochure.

## Large bottom mount

### Features<sup>†</sup>



WBE4504BC



WBE4504SC

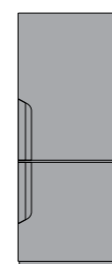

WBE4500BC

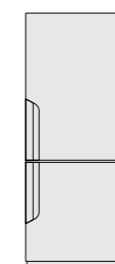

WBE4302AC

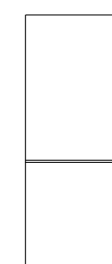

WBE4302WC

|   |                           |                      |
|---|---------------------------|----------------------|
| capacity (litres)                                   | 425                       | 425                  |
| food compartment capacity (litres)                  | 300                       | 300                  |
| freezer compartment capacity (litres)               | 125                       | 125                  |
| overall dimensions* H x W X D (mm) (including door) | 1725 x 699 x 769          | 1725 x 699 x 769     |
| door finish   | dark real stainless steel | real stainless steel |
| stylish flat door design                            | ✓                         | ✓                    |
| energy star rating new                              | 4.5                       | 4.5                  |
| energy consumption (kWhr/yr)                        | 292                       | 292                  |
| inverter compressor motor                           | ✓                         | ✓                    |
| frost-free  | ✓                         | ✓                    |
| electronic temperature controls                     | ✓                         | ✓                    |
| quick freeze function                               | ✓                         | ✓                    |
| door alarm  | fridge                    | fridge               |
| separate temperature controls for fridge & freezer  | ✓                         | ✓                    |
| <b>fridge features</b>                              |                           |                      |
| adjustable SpillSafe glass shelves                  | ✓                         | ✓                    |
| FreshSeal humidity controlled crisper               | ✓                         | ✓                    |
| half width door bins                                | 3                         | 3                    |
| shallow bin   | 1                         | 1                    |
| deep bottle bins                                    | 1                         | 1                    |
| FamilySafe lockable compartment                     | ✓                         | ✓                    |
| feature lighting                                    | blue LED                  | blue LED             |
| main light  | LED                       | LED                  |
| <b>freezer features</b>                             |                           |                      |
| ice cube storage bin                                | ✓                         | ✓                    |
| twist ice and serve                                 | 2 trays                   | 2 trays              |
| large freezer storage drawer                        | ✓                         | ✓                    |
| freezer drawer full-width                           | ✓                         | ✓                    |
| freezer drawer 3/4 width                            | ✓                         | ✓                    |
| freezer basket/drawer runner system                 | telescopic                | telescopic           |
| <b>other features</b>                               |                           |                      |
| door opening  | left or right hand        | left or right hand   |
| hidden hinges                                       | ✓                         | ✓                    |
| adjustable front rollers                            | ✓                         | ✓                    |
| rear rollers  | ✓                         | ✓                    |

\* Overall dimensions include the door and handle. Refer to the dimensions sheet (on page 110 of the brochure) for more details.

<sup>†</sup> Refer to the product information on the back page of this brochure.

|   |                           |                    |                    |
|---|---------------------------|--------------------|--------------------|
| capacity (litres)                                   | 425                       | 425                | 425                |
| food compartment capacity (litres)                  | 300                       | 300                | 300                |
| freezer compartment capacity (litres)               | 125                       | 125                | 125                |
| overall dimensions* H x W X D (mm) (including door) | 1725 x 699 x 723          | 1725 x 699 x 723   | 1725 x 699 x 723   |
| door finish   | dark real stainless steel | silver             | white              |
| stylish flat door design                            | ✓                         | ✓                  | ✓                  |
| energy star rating new                              | 4.5                       | 4.5                | 4.5                |
| energy consumption (kWhr/yr)                        | 292                       | 292                | 292                |
| inverter compressor motor                           | ✓                         | ✓                  | ✓                  |
| frost-free  | ✓                         | ✓                  | ✓                  |
| electronic temperature controls                     | ✓                         | ✓                  | ✓                  |
| quick freeze function                               | ✓                         | ✓                  | ✓                  |
| door alarm  | fridge                    | fridge             | fridge             |
| separate temperature controls for fridge & freezer  | ✓                         | ✓                  | ✓                  |
| <b>fridge features</b>                              |                           |                    |                    |
| adjustable SpillSafe glass shelves                  | ✓                         | ✓                  | ✓                  |
| FreshSeal humidity controlled crisper               | ✓                         | ✓                  | ✓                  |
| half width door bins                                | 3                         | 3                  | 3                  |
| shallow bin   | 1                         | 1                  | 1                  |
| deep bottle bins                                    | 1                         | 1                  | 1                  |
| FamilySafe lockable compartment                     | ✓                         | ✓                  | ✓                  |
| feature lighting                                    | blue LED                  | blue LED           | blue LED           |
| main light  | LED                       | LED                | LED                |
| <b>freezer features</b>                             |                           |                    |                    |
| ice cube storage bin                                | ✓                         | ✓                  | ✓                  |
| twist ice and serve                                 | 2 trays                   | 2 trays            | 2 trays            |
| large freezer storage drawer                        | ✓                         | ✓                  | ✓                  |
| freezer drawer full-width                           | ✓                         | ✓                  | ✓                  |
| freezer drawer 3/4 width                            | ✓                         | ✓                  | ✓                  |
| freezer basket/drawer runner system                 | telescopic                | telescopic         | telescopic         |
| <b>other features</b>                               |                           |                    |                    |
| door opening  | left or right hand        | left or right hand | left or right hand |
| hidden hinges                                       | ✓                         | ✓                  | ✓                  |
| adjustable front rollers                            | ✓                         | ✓                  | ✓                  |
| rear rollers  | ✓                         | ✓                  | ✓                  |

\* Overall dimensions include the door and handle. Refer to the dimensions sheet (on page 110 of the brochure) for more details.

<sup>†</sup> Refer to the product information on the back page of this brochure.

## Large bottom mount

### Features<sup>†</sup>



WBE5304BC

|   |                           |
|---|---------------------------|
| capacity (litres)                                   | 496                       |
| food compartment capacity (litres)                  | 351                       |
| freezer compartment capacity (litres)               | 145                       |
| overall dimensions* H x W X D (mm) (including door) | 1725 x 796 x 769          |
| door finish   | dark real stainless steel |
| stylish flat door design                            | ✓                         |
| energy star rating new                              | 5                         |
| energy consumption (kWhr/yr)                        | 309                       |
| inverter compressor motor                           | ✓                         |
| frost-free  | ✓                         |
| electronic temperature controls                     | ✓                         |
| quick freeze function                               | ✓                         |
| door alarm  | fridge                    |
| separate temperature controls for fridge & freezer  | ✓                         |
| <b>fridge features</b>                              |                           |
| adjustable SpillSafe glass shelves                  | ✓                         |
| FreshSeal humidity controlled crisper               | ✓                         |
| half width door bins                                | 3                         |
| shallow bin   | 1                         |
| deep bottle bins                                    | 1                         |
| FamilySafe lockable compartment                     | ✓                         |
| feature lighting                                    | blue LED                  |
| main light  | LED                       |
| <b>freezer features</b>                             |                           |
| ice cube storage bin                                | ✓                         |
| twist ice and serve                                 | 2 trays                   |
| large freezer storage drawer                        | ✓                         |
| freezer drawer full-width                           | ✓                         |
| freezer drawer 3/4 width                            | ✓                         |
| freezer basket runner/drawer system                 | telescopic                |
| <b>other features</b>                               |                           |
| door opening  | left or right hand        |
| hidden hinges                                       | ✓                         |
| adjustable front rollers                            | ✓                         |
| rear rollers  | ✓                         |

\* Overall dimensions include the door and handle. Refer to the dimensions sheet (on page 110 of the brochure) for more details.

<sup>†</sup> Refer to the product information on the back page of this brochure.



WBE5304SC

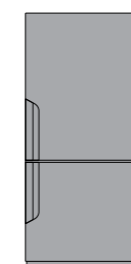

WBE5300BC

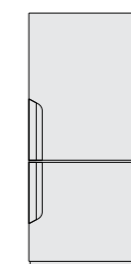

WBE5300SC

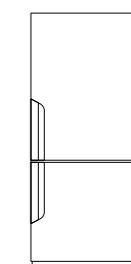

WBE5300WC

|   |                      |                           |                      |                    |
|---|----------------------|---------------------------|----------------------|--------------------|
| capacity (litres)                                   | 496                  | 496                       | 496                  | 496                |
| food compartment capacity (litres)                  | 351                  | 351                       | 351                  | 351                |
| freezer compartment capacity (litres)               | 145                  | 145                       | 145                  | 145                |
| overall dimensions* H x W X D (mm) (including door) | 1725 x 796 x 769     | 1725 x 796 x 723          | 1725 x 796 x 723     | 1725 x 796 x 723   |
| door finish   | real stainless steel | dark real stainless steel | real stainless steel | white              |
| stylish flat door design                            | ✓                    | ✓                         | ✓                    | ✓                  |
| energy star rating new                              | 5                    | 5                         | 5                    | 5                  |
| energy consumption (kWhr/yr)                        | 309                  | 309                       | 309                  | 309                |
| inverter compressor motor                           | ✓                    | ✓                         | ✓                    | ✓                  |
| frost-free  | ✓                    | ✓                         | ✓                    | ✓                  |
| electronic temperature controls                     | ✓                    | ✓                         | ✓                    | ✓                  |
| quick freeze function                               | ✓                    | ✓                         | ✓                    | ✓                  |
| door alarm  | fridge               | fridge                    | fridge               | fridge             |
| separate temperature controls for fridge & freezer  | ✓                    | ✓                         | ✓                    | ✓                  |
| <b>fridge features</b>                              |                      |                           |                      |                    |
| adjustable SpillSafe glass shelves                  | ✓                    | ✓                         | ✓                    | ✓                  |
| FreshSeal humidity controlled crisper               | ✓                    | ✓                         | ✓                    | ✓                  |
| half width door bins                                | 3                    | 3                         | 3                    | 3                  |
| shallow bin   | 1                    | 1                         | 1                    | 1                  |
| deep bottle bins                                    | 1                    | 1                         | 1                    | 1                  |
| FamilySafe lockable compartment                     | ✓                    | ✓                         | ✓                    | ✓                  |
| feature lighting                                    | blue LED             | blue LED                  | blue LED             | blue LED           |
| main light  | LED                  | LED                       | LED                  | LED                |
| <b>freezer features</b>                             |                      |                           |                      |                    |
| ice cube storage bin                                | ✓                    | ✓                         | ✓                    | ✓                  |
| twist ice and serve                                 | 2 trays              | 2 trays                   | 2 trays              | 2 trays            |
| large freezer storage drawer                        | ✓                    | ✓                         | ✓                    | ✓                  |
| freezer drawer full-width                           | ✓                    | ✓                         | ✓                    | ✓                  |
| freezer drawer 3/4 width                            | ✓                    | ✓                         | ✓                    | ✓                  |
| freezer basket runner/drawer system                 | telescopic           | telescopic                | telescopic           | telescopic         |
| <b>other features</b>                               |                      |                           |                      |                    |
| door opening  | left or right hand   | left or right hand        | left or right hand   | left or right hand |
| hidden hinges                                       | ✓                    | ✓                         | ✓                    | ✓                  |
| adjustable front rollers                            | ✓                    | ✓                         | ✓                    | ✓                  |
| rear rollers  | ✓                    | ✓                         | ✓                    | ✓                  |

\* Overall dimensions include the door and handle. Refer to the dimensions sheet (on page 110 of the brochure) for more details.

<sup>†</sup> Refer to the product information on the back page of this brochure.

## Compact bottom mount

### Features<sup>†</sup>



NEW

WBB3400AK

|   |                         |
|---|-------------------------|
| capacity (litres)                                   | 335                     |
| food compartment capacity (litres)                  | 250                     |
| freezer compartment capacity (litres)               | 85                      |
| overall dimensions* H x W X D (mm) (including door) | 1756 x 598 x 650        |
| door finish   | arctic silver           |
| energy star rating                                  | 3.5                     |
| energy consumption (kWh/year)                       | 315                     |
| frost-free  | ✓                       |
| multi-flow air delivery system                      | ✓                       |
| separate temperature controls for fridge & freezer  | ✓                       |
| fridge door alarm                                   | ✓                       |
| <b>fridge features</b>                              |                         |
| adjustable glass shelves                            | 3                       |
| full-width crisper bin                              | ✓                       |
| dairy compartment                                   | ✓                       |
| full-width bottle bins                              | 1                       |
| 1/3 door bins                                       | 2                       |
| 2/3 door bins                                       | 2                       |
| egg tray  | ✓                       |
| interior fridge light                               | LED                     |
| <b>freezer features</b>                             |                         |
| twist ice server/storage bin                        | ✓                       |
| freezer basket (half-width)                         | 1                       |
| freezer basket (full-width)                         | 2                       |
| <b>other features</b>                               |                         |
| R600a refrigerant                                   | ✓                       |
| hidden hinges                                       | ✓                       |
| door opening  | reversible <sup>1</sup> |
| rear rollers  | ✓                       |
| levelling legs                                      | ✓                       |
| integration kit available                           | ✓                       |

\* Overall dimensions include the door and handle. Refer to the dimensions sheet (on page 110 of the brochure) for more details.

<sup>†</sup> Refer to the product information on the back page of this brochure.



NEW

WBB3400WK

|   |                         |                         |                         |
|---|-------------------------|-------------------------|-------------------------|
| capacity (litres)                                   | 335                     | 308                     | 308                     |
| food compartment capacity (litres)                  | 250                     | 223                     | 223                     |
| freezer compartment capacity (litres)               | 85                      | 85                      | 85                      |
| overall dimensions* H x W X D (mm) (including door) | 1756 x 598 x 650        | 1650 x 598 x 650        | 1650 x 598 x 650        |
| door finish   | white                   | arctic silver           | white                   |
| energy star rating                                  | 3.5                     | 3.5                     | 3.5                     |
| energy consumption (kWh/year)                       | 315                     | 310                     | 310                     |
| frost-free  | ✓                       | ✓                       | ✓                       |
| multi-flow air delivery system                      | ✓                       | ✓                       | ✓                       |
| separate temperature controls for fridge & freezer  | ✓                       | ✓                       | ✓                       |
| fridge door alarm                                   | ✓                       | ✓                       | ✓                       |
| <b>fridge features</b>                              |                         |                         |                         |
| adjustable glass shelves                            | 3                       | 3                       | 3                       |
| full-width crisper bin                              | ✓                       | ✓                       | ✓                       |
| dairy compartment                                   | ✓                       | ✓                       | ✓                       |
| full-width bottle bins                              | 1                       | 1                       | 1                       |
| 1/3 door bins                                       | 2                       | 2                       | 2                       |
| 2/3 door bins                                       | 2                       | 2                       | 2                       |
| egg tray  | ✓                       | ✓                       | ✓                       |
| interior fridge light                               | LED                     | LED                     | LED                     |
| <b>freezer features</b>                             |                         |                         |                         |
| twist ice server/storage bin                        | ✓                       | ✓                       | ✓                       |
| freezer basket (half-width)                         | 1                       | 1                       | 1                       |
| freezer basket (full-width)                         | 2                       | 2                       | 2                       |
| <b>other features</b>                               |                         |                         |                         |
| R600a refrigerant                                   | ✓                       | ✓                       | ✓                       |
| hidden hinges                                       | ✓                       | ✓                       | ✓                       |
| door opening  | reversible <sup>1</sup> | reversible <sup>1</sup> | reversible <sup>1</sup> |
| rear rollers  | ✓                       | ✓                       | ✓                       |
| levelling legs                                      | ✓                       | ✓                       | ✓                       |
| integration kit available                           | ✓                       | ✓                       | ✓                       |

\* Overall dimensions include the door and handle. Refer to the dimensions sheet (on page 110 of the brochure) for more details.

<sup>†</sup> Refer to the product information on the back page of this brochure.

## Large top mount

### Features<sup>†</sup>

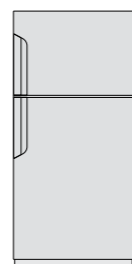

WTB4600SC

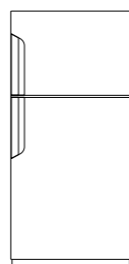

WTB4600WC

|   |                      |                  |
|---|----------------------|------------------|
| capacity (litres)                                   | 431                  | 431              |
| food compartment capacity (litres)                  | 329                  | 329              |
| freezer compartment capacity (litres)               | 102                  | 102              |
| overall dimensions* H x W X D (mm) (including door) | 1725 x 699 x 723     | 1725 x 699 x 723 |
| door finish   | real stainless steel | White            |
| stylish flat door design                            | ✓                    | ✓                |
| energy star rating new                              | 4                    | 4                |
| energy consumption (kWhr/yr)                        | 336                  | 336              |
| inverter compressor motor                           | ✓                    | ✓                |
| frost-free  | ✓                    | ✓                |
| electronic temperature controls                     | ✓                    | ✓                |
| quick chill alarm                                   | ✓                    | ✓                |
| door alarm  | fridge               | fridge           |
| separate temperature controls for fridge & freezer  | ✓                    | ✓                |

| fridge features                       |            |            |
|---------------------------------------|------------|------------|
| adjustable SpillSafe glass shelves    | 2          | 2          |
| FreshSeal humidity controlled crisper | ✓          | ✓          |
| half width door bins                  | 4          | 4          |
| shallow bin                           | 1          | 1          |
| deep bottle bins                      | 1          | 1          |
| bottle fingers                        | ✓          | ✓          |
| chiller compartment                   | full-width | full-width |
| Family Safe lockable compartment      | ✓          | ✓          |
| feature lighting                      | blue LED   | blue LED   |
| main light                            | LED        | LED        |

| freezer features      |   |   |
|-----------------------|---|---|
| ice cube storage bin  | ✓ | ✓ |
| twist ice and serve   | 2 | 2 |
| SpillSafe glass shelf | 1 | 1 |
| full-width door bin   | 1 | 1 |

| other features           |                    |                    |
|--------------------------|--------------------|--------------------|
| door opening             | left or right hand | left or right hand |
| hidden hinges            | ✓                  | ✓                  |
| adjustable front rollers | ✓                  | ✓                  |
| rear rollers             | ✓                  | ✓                  |

\* Overall dimensions include the door and handle. Refer to the dimensions sheet (on page 110 of the brochure) for more details.

<sup>†</sup> Refer to the product information on the back page of this brochure.



WTB4604SC

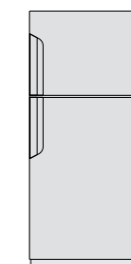

WTB5400SC

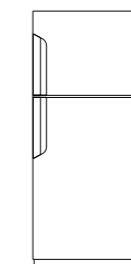

WTB5400WC



WTB5404SC

|   |                      |                      |                  |                      |
|---|----------------------|----------------------|------------------|----------------------|
| capacity (litres)                                   | 431                  | 503                  | 503              | 503                  |
| food compartment capacity (litres)                  | 329                  | 384                  | 384              | 384                  |
| freezer compartment capacity (litres)               | 102                  | 119                  | 119              | 119                  |
| overall dimensions* H x W X D (mm) (including door) | 1725 x 699 x 769     | 1725 x 796 x 723     | 1725 x 796 x 723 | 1725 x 796 x 769     |
| door finish   | real stainless steel | real stainless steel | White            | real stainless steel |
| stylish flat door design                            | ✓                    | ✓                    | ✓                | ✓                    |
| energy star rating new                              | 4                    | 4                    | 4                | 4                    |
| energy consumption (kWhr/yr)                        | 336                  | 353                  | 353              | 353                  |
| inverter compressor motor                           | ✓                    | ✓                    | ✓                | ✓                    |
| frost-free  | ✓                    | ✓                    | ✓                | ✓                    |
| electronic temperature controls                     | ✓                    | ✓                    | ✓                | ✓                    |
| quick chill alarm                                   | ✓                    | ✓                    | ✓                | ✓                    |
| door alarm  | fridge               | fridge               | fridge           | fridge               |
| separate temperature controls for fridge & freezer  | ✓                    | ✓                    | ✓                | ✓                    |

| fridge features                       |            |               |               |               |
|---------------------------------------|------------|---------------|---------------|---------------|
| adjustable SpillSafe glass shelves    | 2          | 2             | 2             | 2             |
| FreshSeal humidity controlled crisper | ✓          | ✓             | ✓             | ✓             |
| half width door bins                  | 4          | 4             | 4             | 4             |
| shallow bin                           | 1          | 1             | 1             | 1             |
| deep bottle bins                      | 1          | 1             | 1             | 1             |
| bottle fingers                        | ✓          | ✓             | ✓             | ✓             |
| chiller compartment                   | full-width | small + large | small + large | small + large |
| Family Safe lockable compartment      | ✓          | ✓             | ✓             | ✓             |
| feature lighting                      | blue LED   | blue LED      | blue LED      | blue LED      |
| main light                            | LED        | LED           | LED           | LED           |

| freezer features      |   |   |   |   |
|-----------------------|---|---|---|---|
| ice cube storage bin  | ✓ | ✓ | ✓ | ✓ |
| twist ice and serve   | 2 | 2 | 2 | 2 |
| SpillSafe glass shelf | 1 | 1 | 1 | 1 |
| full-width door bin   | 1 | 1 | 1 | 1 |

| other features           |                    |                    |                    |                    |
|--------------------------|--------------------|--------------------|--------------------|--------------------|
| door opening             | left or right hand | left or right hand | left or right hand | left or right hand |
| hidden hinges            | ✓                  | ✓                  | ✓                  | ✓                  |
| adjustable front rollers | ✓                  | ✓                  | ✓                  | ✓                  |
| rear rollers             | ✓                  | ✓                  | ✓                  | ✓                  |

## Compact top mount

### Features†



NEW

WTB3400AK/WK



NEW

WTB3100AK/WK

|   |                         |                         |
|---|-------------------------|-------------------------|
| capacity (litres)                                   | 341                     | 312                     |
| food compartment capacity (litres)                  | 267                     | 238                     |
| freezer compartment capacity (litres)               | 74                      | 74                      |
| overall dimensions* H x W X D (mm) (including door) | 1756 x 598 x 650        | 1650 x 598 x 650        |
| door finish   | arctic silver/white     | arctic silver/white     |
| energy star rating                                  | 3                       | 3                       |
| energy consumption (kWh/year)                       | 339                     | 336                     |
| frost-free  | ✓                       | ✓                       |
| multi-flow air delivery system                      | ✓                       | ✓                       |
| separate temperature controls for fridge & freezer  | ✓                       | ✓                       |
| fridge door alarm                                   | ✓                       | ✓                       |
| fingerprint-resistant surface                       | ✓                       | ✓                       |
| <b>fridge features</b>                              |                         |                         |
| adjustable glass shelves                            | 3                       | 3                       |
| full-width chiller compartment                      | ✓                       | ✓                       |
| bottle caddy  | ✓                       | ✓                       |
| full width crisper                                  |                         |                         |
| full-width door bins                                | 2                       | 2                       |
| 1/3 door bins                                       | 2                       | 2                       |
| 2/3 door bins                                       | 2                       | 2                       |
| interior fridge light                               | LED                     | LED                     |
| <b>freezer features</b>                             |                         |                         |
| easy clean glass shelves                            | ✓                       | ✓                       |
| wire/plastic shelves                                |                         |                         |
| twist ice server/storage bin                        | ✓                       | ✓                       |
| full-width door bins                                | 2                       | 2                       |
| <b>other features</b>                               |                         |                         |
| R600a refrigerant                                   | ✓                       | ✓                       |
| hidden hinges                                       | ✓                       | ✓                       |
| door opening  | reversible <sup>1</sup> | reversible <sup>1</sup> |
| rear rollers  | ✓                       | ✓                       |
| levelling legs                                      | ✓                       | ✓                       |
| integration kit available                           | ✓                       | ✓                       |



WTB2800AH/WH



WTB2500WH

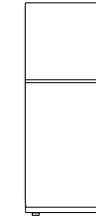

WTB2300WH

|   |                         |                         |                         |
|---|-------------------------|-------------------------|-------------------------|
| capacity (litres)                                   | 256                     | 225                     | 211                     |
| food compartment capacity (litres)                  | 194                     | 163                     | 149                     |
| freezer compartment capacity (litres)               | 62                      | 62                      | 62                      |
| overall dimensions* H x W X D (mm) (including door) | 1605 x 540 x 615        | 1470 x 540 x 615        | 1405 x 540 x 615        |
| door finish   | arctic silver/white     | classic white           | classic white           |
| energy star rating                                  | 3                       | 3                       | 3                       |
| energy consumption (kWh/year)                       | 283                     | 279                     | 259                     |
| frost-free  | ✓                       | ✓                       | ✓                       |
| multi-flow air delivery system                      | ✓                       | ✓                       | ✓                       |
| separate temperature controls for fridge & freezer  | ✓                       | ✓                       | ✓                       |
| fridge door alarm                                   | ✓                       | ✓                       | ✓                       |
| <b>fridge features</b>                              |                         |                         |                         |
| adjustable glass shelves                            | 2                       | 2                       | 2                       |
| full-width chiller compartment                      | ✓                       | ✓                       | ✓                       |
| bottle caddy  |                         |                         |                         |
| full width crisper                                  | ✓                       | ✓                       | ✓                       |
| full-width door bins                                | 2                       | 2                       | 2                       |
| 1/3 door bins                                       | 3                       | 3                       | 3                       |
| interior fridge light                               | LED                     | LED                     | LED                     |
| <b>freezer features</b>                             |                         |                         |                         |
| easy clean glass shelves                            |                         |                         |                         |
| wire/plastic shelves                                | ✓                       | ✓                       | ✓                       |
| twist ice server/storage bin                        | ✓                       | ✓                       | ✓                       |
| full-width door bins                                | 2                       | 2                       | 2                       |
| <b>other features</b>                               |                         |                         |                         |
| R600a refrigerant                                   | ✓                       | ✓                       | ✓                       |
| hidden hinges                                       | ✓                       | ✓                       | ✓                       |
| door opening  | reversible <sup>1</sup> | reversible <sup>1</sup> | reversible <sup>1</sup> |
| rear rollers  | ✓                       | ✓                       | ✓                       |
| levelling legs                                      | ✓                       | ✓                       | ✓                       |
| integration kit available                           | ✓                       | ✓                       | ✓                       |

<sup>1</sup> For those wanting a left hand opening door for models WTB2300, WTB2500, WTB2800, WTB3400 or WTB3700, please order reversing kit ACC096.

<sup>2</sup> No additional parts required to reverse the doors for models WTM200WC & WTM1800WC.

\* Overall dimensions include the door and handle. Refer to the dimensions sheet (on page 110 of the brochure) for more details.

† Refer to the product information on the back page of this brochure.

## side by sides

### Features†

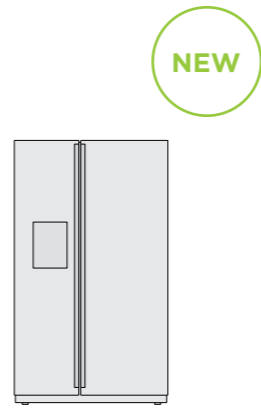

**WSE6640BA**

|  |                  |
|--|------------------|
| capacity (litres)                                      | 619              |
| food compartment capacity (litres)                     | 402              |
| freezer compartment capacity (litres)                  | 217              |
| overall dimensions* H x W X D (mm) (including door)    | 1780 x 911 x 746 |
| door finish  | black            |
| energy star rating                                     | 4.5              |
| energy consumption (kWh/year)                          | 405              |
| filtered ice and water dispenser (cubed & crushed ice) |                  |
| water only dispenser                                   | ✓                |
| frost-free   |                  |
| separate temperature controls for fridge and freezer   | ✓                |
| fingerprint-resistant surface                          | ✓                |
| fingerprint-resistant surface                          | ✓                |
| <b>electronic controls</b>                             | ✓                |
| door alarm   | ✓                |
| drinks chill timer                                     | ✓                |
| quick freeze function                                  | ✓                |
| holiday mode   | ✓                |
| <b>fridge features</b>                                 |                  |
| crispers   | 2                |
| adjustable SpillSafe glass shelves                     | 3                |
| full width door bins                                   | 4                |
| interior fridge light                                  | LED              |
| <b>freezer features</b>                                |                  |
| automatic icemaker                                     |                  |
| freezer bins   | 2                |
| SpillSafe slide-out glass shelves                      | 3                |
| twist ice and serve                                    | 2                |
| interior freezer light                                 | LED              |
| <b>other features</b>                                  |                  |
| adjustable front rollers                               | ✓                |
| rear rollers   | ✓                |
| water filter accessory                                 |                  |

\* Overall dimensions include the door and handle. Refer to the dimensions sheet (on page 110 of the brochure) for more details.

† Refer to the product information on the back page of this brochure.

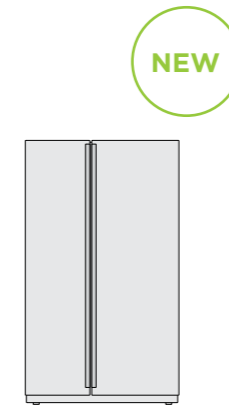

**WSE6630SA**

### Features†

|  |                  |                  |
|--|------------------|------------------|
| capacity (litres)                                      | 624              | 624              |
| food compartment capacity (litres)                     | 407              | 407              |
| freezer compartment capacity (litres)                  | 217              | 217              |
| overall dimensions* H x W X D (mm) (including door)    | 1780 x 911 x 746 | 1780 x 911 x 746 |
| door finish  | silver           | white            |
| energy star rating                                     | 4.5              | 4.5              |
| energy consumption (kWh/year)                          | 405              | 405              |
| filtered ice and water dispenser (cubed & crushed ice) | ✓                | ✓                |
| water only dispenser                                   |                  |                  |
| frost-free   |                  |                  |
| separate temperature controls for fridge and freezer   | ✓                | ✓                |
| fingerprint-resistant surface                          | ✓                | ✓                |
| fingerprint-resistant surface                          | ✓                | ✓                |
| <b>electronic controls</b>                             | ✓                | ✓                |
| door alarm   | ✓                | ✓                |
| drinks chill timer                                     | ✓                | ✓                |
| quick freeze function                                  | ✓                | ✓                |
| holiday mode   | ✓                | ✓                |
| <b>fridge features</b>                                 |                  |                  |
| crispers   | 2                | 2                |
| adjustable SpillSafe glass shelves                     | 3                | 3                |
| full width door bins                                   | 4                | 4                |
| interior fridge light                                  | LED              | LED              |
| <b>freezer features</b>                                |                  |                  |
| automatic icemaker                                     |                  |                  |
| freezer bins   | 2                | 2                |
| SpillSafe slide-out glass shelves                      | 3                | 3                |
| twist ice and serve                                    | 2                | 2                |
| interior freezer light                                 | LED              | LED              |
| <b>other features</b>                                  |                  |                  |
| adjustable front rollers                               | ✓                | ✓                |
| rear rollers   | ✓                | ✓                |
| water filter accessory                                 |                  |                  |

\* Overall dimensions include the door and handle. Refer to the dimensions sheet (on page 110 of the brochure) for more details.

† Refer to the product information on the back page of this brochure.

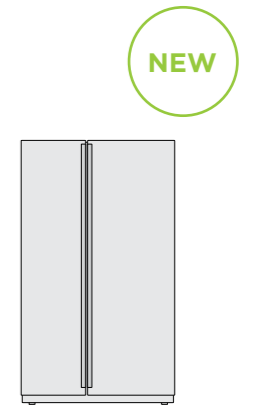

**WSE6630WA**



## Single door fridges

### Features†



WRB5004SC

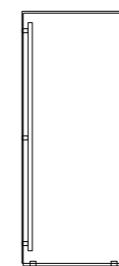

WRB5004WC



WRB3504SA

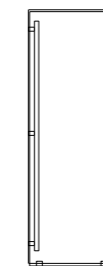

WRB3504WA



WRM2400WE

|   |                      |
|---|----------------------|
| capacity (litres)                                   | 466                  |
| stylish flat door design                            | ✓                    |
| door finish   | stainless steel      |
| overall dimensions* H x W X D (mm) (including door) | 1725 x 699 x 769     |
| energy star rating                                  | 4                    |
| energy consumption (kWh/year)                       | 195                  |
| inverter compressor motor                           | ✓                    |
| frost-free  | ✓                    |
| separate temperature control                        | ✓                    |
| control functions                                   | quick chill function |
| multi-flow air delivery system                      | ✓                    |
| <b>fridge features</b>                              |                      |
| deli compartment                                    | ✓                    |
| adjustable SpillSafe glass shelves                  | ✓                    |
| adjustable tempered glass shelves                   |                      |
| full width crisper bin                              |                      |
| FreshSeal humidity controlled crisper bin           | 1                    |
| FlexStor door bins                                  | 4                    |
| FamilySafe lockable compartment                     | ✓                    |
| dairy compartment with lid                          |                      |
| adjustable full width bottle bins                   |                      |
| bottle fingers                                      | 2                    |
| egg tray  | ✓                    |
| interior fridge light                               | LED                  |
| <b>other features</b>                               |                      |
| R600a refrigerant                                   | ✓                    |
| door opening  | left or right hand   |
| adjustable front rollers                            | ✓                    |
| adjustable front levelling leg                      |                      |
| rear rollers  | ✓                    |
| integration kit available                           | ✓                    |

|   | WRB5004WC            | WRB3504SA             | WRB3504WA             | WRM2400WE             |
|---|----------------------|-----------------------|-----------------------|-----------------------|
| capacity (litres)                                   | 466                  | 328                   | 328                   | 242                   |
| stylish flat door design                            | ✓                    |                       |                       |                       |
| door finish   | classic white        | stainless steel       | classic white         | classic white         |
| overall dimensions* H x W X D (mm) (including door) | 1725 x 699 x 769     | 1746 x 595 x 700      | 1746 x 595 x 700      | 1434 x 550 x 545      |
| energy star rating                                  | 4                    | 3.5                   | 3.5                   | 3                     |
| energy consumption (kWh/year)                       | 195                  | 182                   | 182                   | 175                   |
| inverter compressor motor                           | ✓                    |                       |                       |                       |
| frost-free  | ✓                    | ✓                     | ✓                     |                       |
| separate temperature control                        | ✓                    | ✓                     | ✓                     | ✓                     |
| control functions                                   | quick chill function | quick chill function  | quick chill function  |                       |
| multi-flow air delivery system                      | ✓                    | ✓                     | ✓                     |                       |
| <b>fridge features</b>                              |                      |                       |                       |                       |
| deli compartment                                    | ✓                    |                       |                       |                       |
| adjustable SpillSafe glass shelves                  | ✓                    | ✓                     | ✓                     |                       |
| adjustable tempered glass shelves                   |                      |                       |                       | ✓                     |
| full width crisper bin                              |                      |                       |                       | 1                     |
| FreshSeal humidity controlled crisper bin           | 1                    | 2                     | 2                     |                       |
| FlexStor door bins                                  | 4                    | 5                     | 5                     |                       |
| FamilySafe lockable compartment                     | ✓                    |                       |                       |                       |
| dairy compartment with lid                          |                      | ✓                     | ✓                     |                       |
| adjustable full width bottle bins                   |                      |                       |                       | 4                     |
| bottle fingers                                      | 2                    |                       |                       |                       |
| egg tray  | ✓                    | ✓                     | ✓                     | ✓                     |
| interior fridge light                               | LED                  | LED                   | LED                   | LED                   |
| <b>other features</b>                               |                      |                       |                       |                       |
| R600a refrigerant                                   | ✓                    | ✓                     | ✓                     | ✓                     |
| door opening  | left or right hand   | reversible (included) | reversible (included) | reversible (included) |
| adjustable front rollers                            | ✓                    |                       |                       |                       |
| adjustable front levelling leg                      |                      | ✓                     | ✓                     | ✓                     |
| rear rollers  | ✓                    | ✓                     | ✓                     | ✓                     |
| integration kit available                           | ✓                    |                       |                       |                       |

\* Overall dimensions include the door and handle. Refer to the dimensions sheet (on page 110 of the brochure) for more details.  
 † Refer to the product information on the back page of this brochure.

## Vertical freezers

### Features†



WFB4204SC



WFB4204WC



WFB2804SA



WFB2804WA

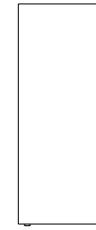

WFM1700WE

|   |                            |
|---|----------------------------|
| capacity (litres)                                   | 388                        |
| stylish flat door design                            | ✓                          |
| door finish   | stainless steel            |
| overall dimensions* H x W X D (mm) (including door) | 1725 x 699 x 769           |
| energy star rating                                  | 3.5                        |
| energy consumption (kWh/year)                       | 309                        |
| inverter compressor motor                           | ✓                          |
| frost-free  | ✓                          |
| separate temperature control                        | ✓                          |
| multi-flow air delivery system                      | ✓                          |
| <b>freezer features</b>                             |                            |
| twist ice and serve/trays                           | 2/-                        |
| ice cube storage bin                                | ✓                          |
| adjustable glass shelves                            | 3                          |
| full-width freezer baskets                          | 4                          |
| freezer light                                       | LED                        |
| <b>other features</b>                               |                            |
| R600a refrigerant                                   | ✓                          |
| door opening  | Left or right hand opening |
| adjustable front rollers                            | ✓                          |
| adjustable front levelling leg                      |                            |
| rear rollers  | ✓                          |
| integration kit available                           | ✓                          |

|                            |                       |                       |                       |
|----------------------------|-----------------------|-----------------------|-----------------------|
| 388                        | 254                   | 254                   | 155                   |
| ✓                          |                       |                       |                       |
| classic white              | stainless steel       | classic white         | classic white         |
| 1725 x 699 x 769           | 1746 x 595 x 700      | 1746 x 595 x 700      | 1434 x 550 x 560      |
| 3.5                        | 3                     | 3                     | 3                     |
| 309                        | 286                   | 286                   | 228                   |
| ✓                          |                       |                       |                       |
| ✓                          | ✓                     | ✓                     | ✓                     |
| ✓                          | ✓                     | ✓                     | ✓                     |
| ✓                          | ✓                     | ✓                     | ✓                     |
| <b>2/-</b>                 |                       | <b>2/-</b>            |                       |
| ✓                          | ✓                     | ✓                     |                       |
| 3                          |                       |                       | 1 (non-adjustable)    |
| 4                          | 6                     | 6                     | 4                     |
| LED                        | LED                   | LED                   |                       |
| <b>✓</b>                   |                       | <b>✓</b>              |                       |
| Left or right hand opening | reversible (included) | reversible (included) | reversible (included) |
| ✓                          |                       |                       |                       |
|                            | ✓                     | ✓                     | ✓                     |
| ✓                          | ✓                     | ✓                     | ✓                     |
| ✓                          |                       |                       |                       |

\* Overall dimensions include the door and handle. Refer to the dimensions sheet (on page 110 of the brochure) for more details.

† Refer to the product information on the back page of this brochure.

# Dimensions and installation guide

## Side by sides

WSE6640, WSE6630

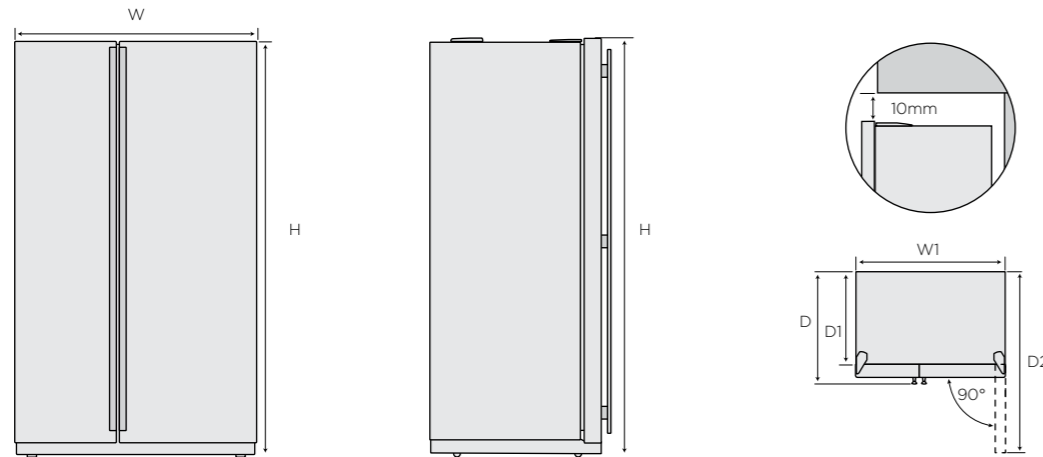

### Recommended minimum clearances

Please note: Doors are designed to sit proud of cabinetry (not flush).

When positioned in a corner area, clearance of at least 350mm on the fridge side and 250mm on the freezer side will allow the doors to open enough to enable the removal of the bins and shelves.

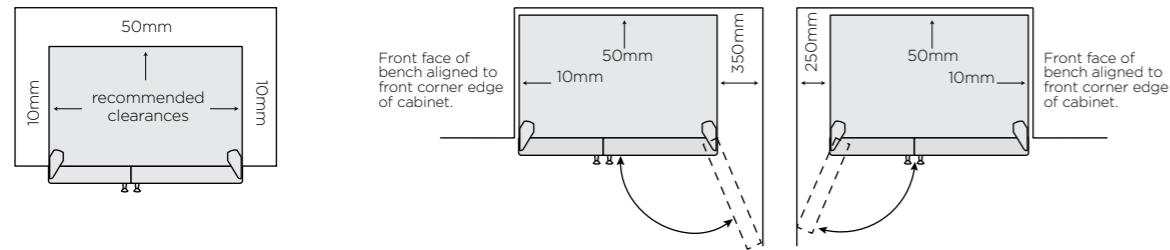

## Verticals and pigeon pairs†

WRB5004, WFB4204, WRB3504, WFB2804

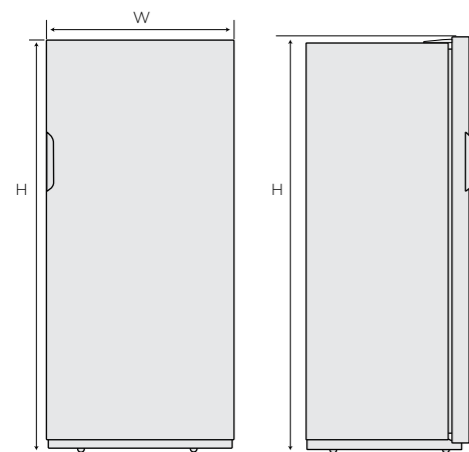

### Recommended minimum clearances

Please note: Doors are designed to sit proud of cabinetry (not flush).

If you have a cupboard above the refrigerator with a rear gap of less than 100mm (Y), recommended minimum clearance at the top of the refrigerator increases from 30mm to 70mm (X).

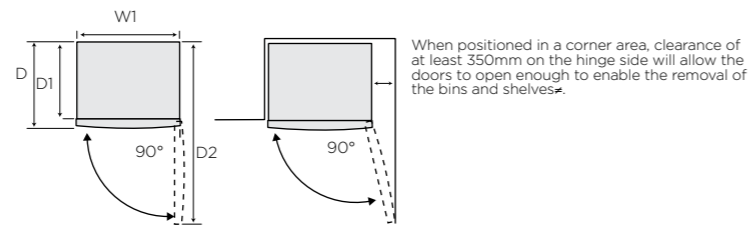
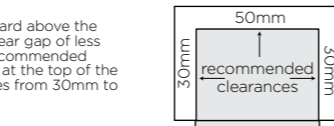

## Large and compact French doors†

WHE6060, WHE6000, WHE5204, WHE5264, WHE5204

WHE6874, WHE7074

WQE6060, WQE6000, WQE6000, WQE6060

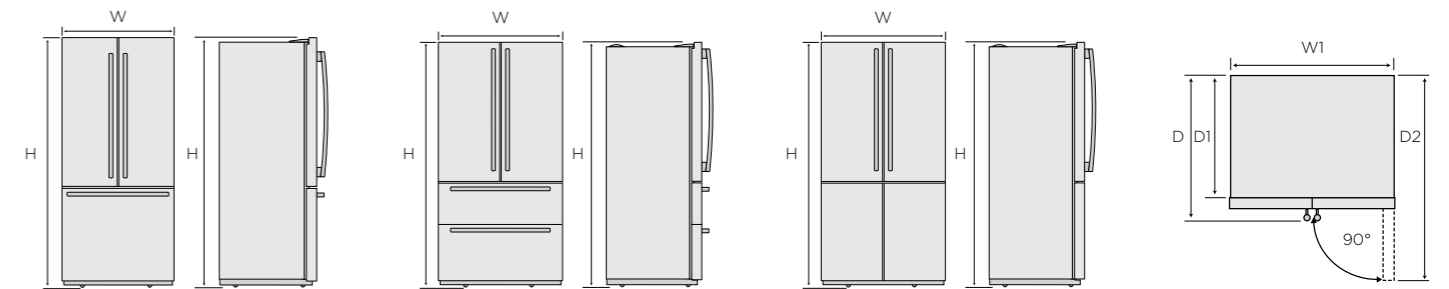

### Recommended minimum clearances

Please note: Doors are designed to sit proud of cabinetry (not flush).

WHE6170, WHE6270

WQE6060, WQE6000, WHE6000, WHE6060, WQE6000, WQE6060

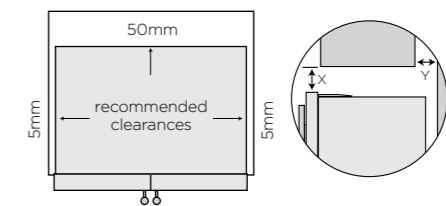
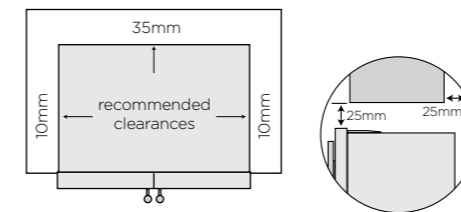

If you have a cupboard above the refrigerator with a rear gap of less than 100mm (Y), recommended minimum clearance at the top of the refrigerator increases from 30mm to 70mm (X).

WHE5204, WHE5264, WHE5204

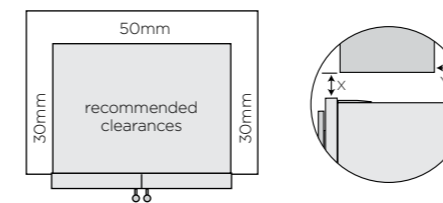

If you have a cupboard above the refrigerator with a rear gap of less than 100mm (Y), recommended minimum clearance at the top of the refrigerator increases from 30mm to 70mm (X).

WQE6000, WQE6060, WQE6060, WQE6000, WHE6060, WHE6000, WHE5204, WHE5264, WHE5204

WHE6170, WHE6270

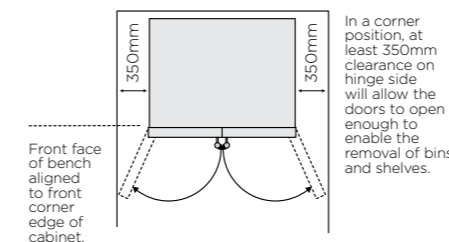

In a corner position, at least 350mm clearance on hinge side will allow the doors to open enough to enable the removal of bins and shelves.

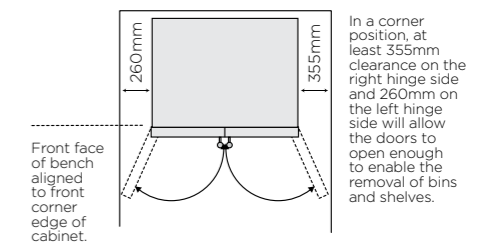

In a corner position, at least 355mm clearance on the right hinge side and 260mm on the left hinge side will allow the doors to open enough to enable the removal of bins and shelves.

|               | Model         | Door Width (W) | Total Depth (D) | Max Height (H) | Cabinet Width (W1) | Cabinet Depth (D1) | Cabinet Height (H1) |
|---------------|---------------|----------------|-----------------|----------------|--------------------|--------------------|---------------------|
| Side by sides | WSE6640BA     | 911            | 746             | 1780           | 911                | 664                | 1780                |
|               | WSE6630SA/ WA | 911            | 746             | 1780           | 911                | 664                | 1780                |

† Refer to the product information on the back page of this brochure.

‡ For those single door models with telescopic extension slide-out bins or crispers situated with the door opening against the wall, clearance requirement increases from 350mm to 450mm.

For information on installation of integration kits for top mounts, bottom mounts and pigeon pair models, please refer to westinghouse.com.au

|             | Model  | Door width (W) | Total depth (D) | Max height (H) | Cabinet width (W1) | Cabinet depth (D1) | Depth door open (D2) |
|-------------|--|----------------|-----------------|----------------|--------------------|--------------------|----------------------|
| French door | WHE6170, WHE6270                                     | 913            | 803             | 1782           | 908                | 625                | 1189                 |
|             | WQE6060, WQE6000, WHE6060, WHE6000, WQE6000, WQE6060 | 896            | 781             | 1725           | 890                | 641                | 1105                 |
|             | WHE5204, WHE5264, WHE5204                            | 796            | 769             | 1725           | 790                | 641                | 1057                 |

† Refer to the product information on the back page of this brochure

# Dimensions and installation guide

## Large bottom mounts†

WBE5300, WBE5304, WBE4500, WBE4504, WBE4302

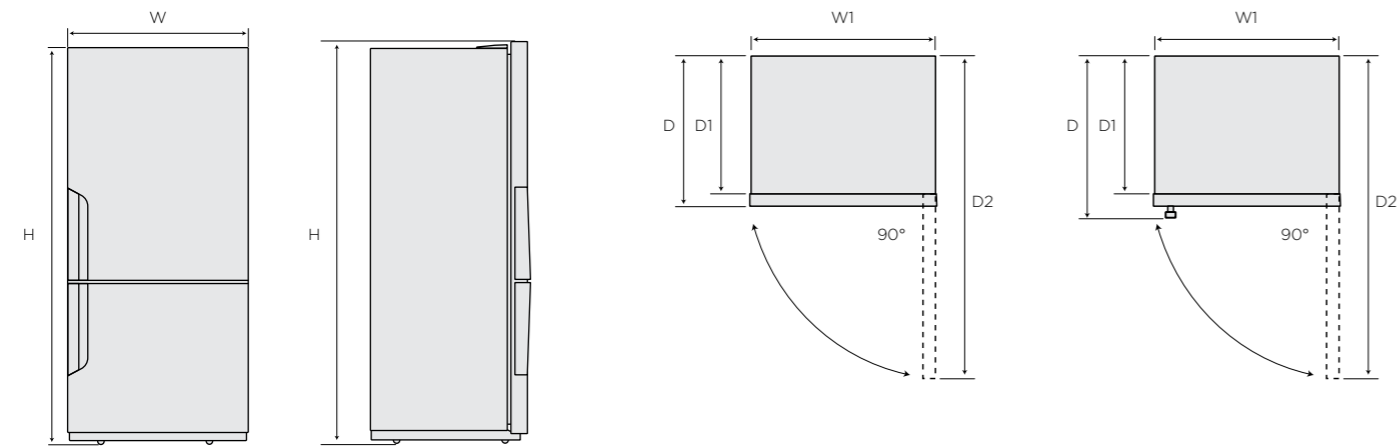

WBE5300, WBE4500, WBE4302

WBE5304, WBE4504

## Large top mounts†

WTB5404, WTB5400, WTB4604, WTB4600

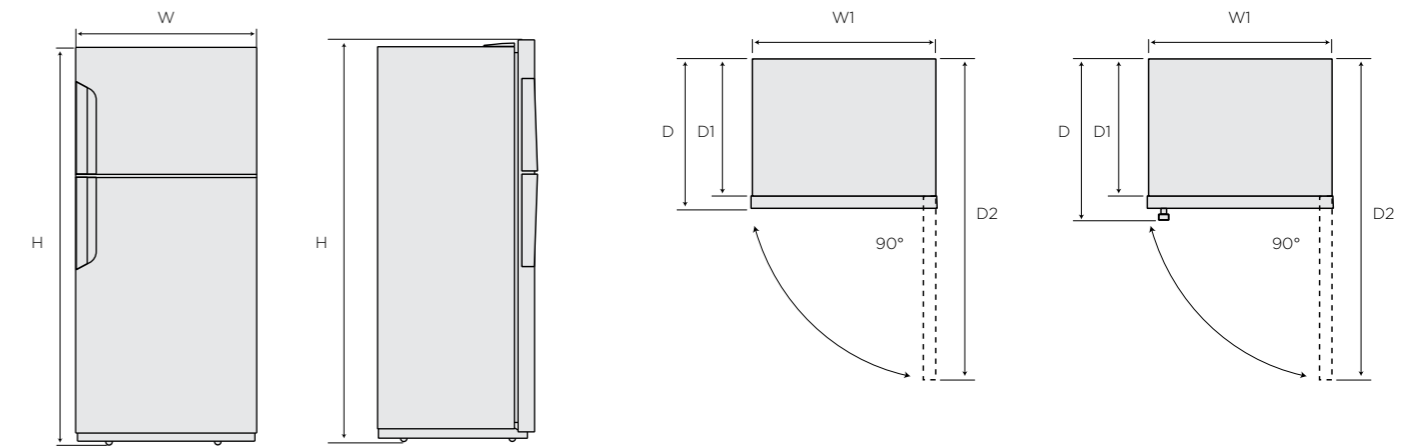

WTB5400, WTB4600

WTB5404, WTB4604

### Recommended minimum clearances

Please note: Doors are designed to sit proud of cabinetry (not flush).

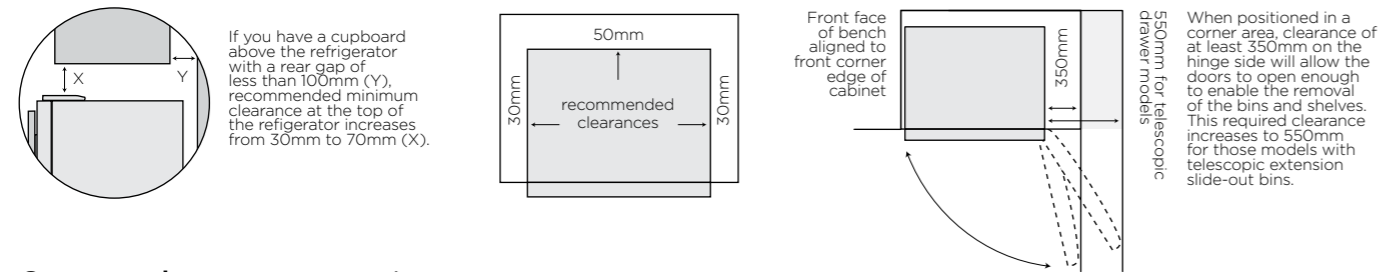

### Recommended minimum clearances

Please note: Doors are designed to sit proud of cabinetry (not flush).

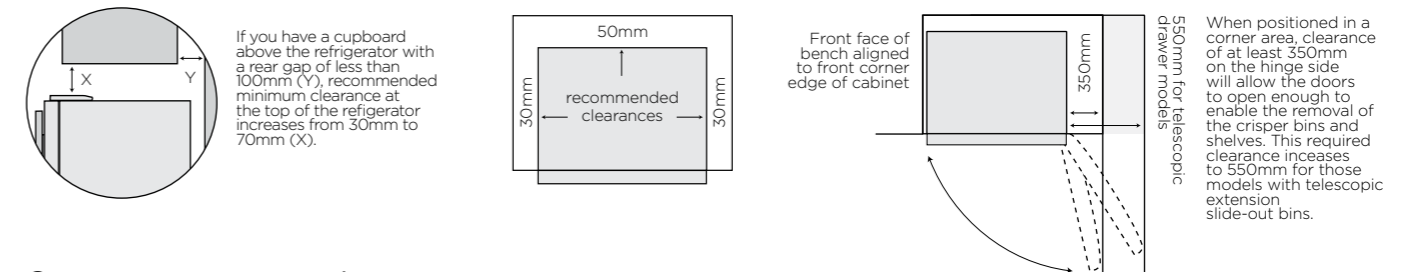

## Compact bottom mounts†

WTB3400, WTB3100, WTB2800, WTB2500, WTB2300

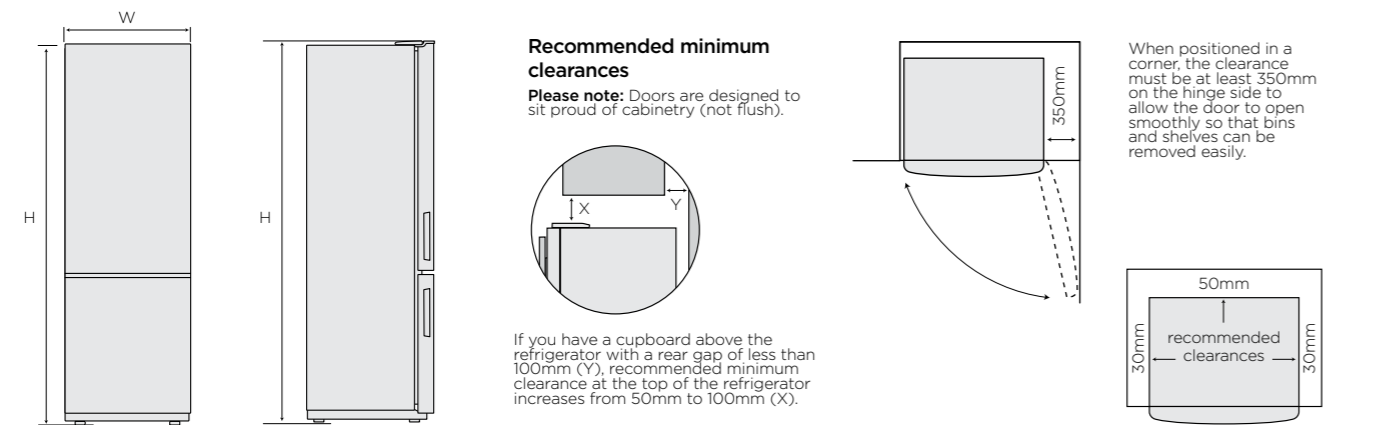

## Compact top mounts†

WTB3400, WTB3100, WTB2800, WTB2500, WTB2300

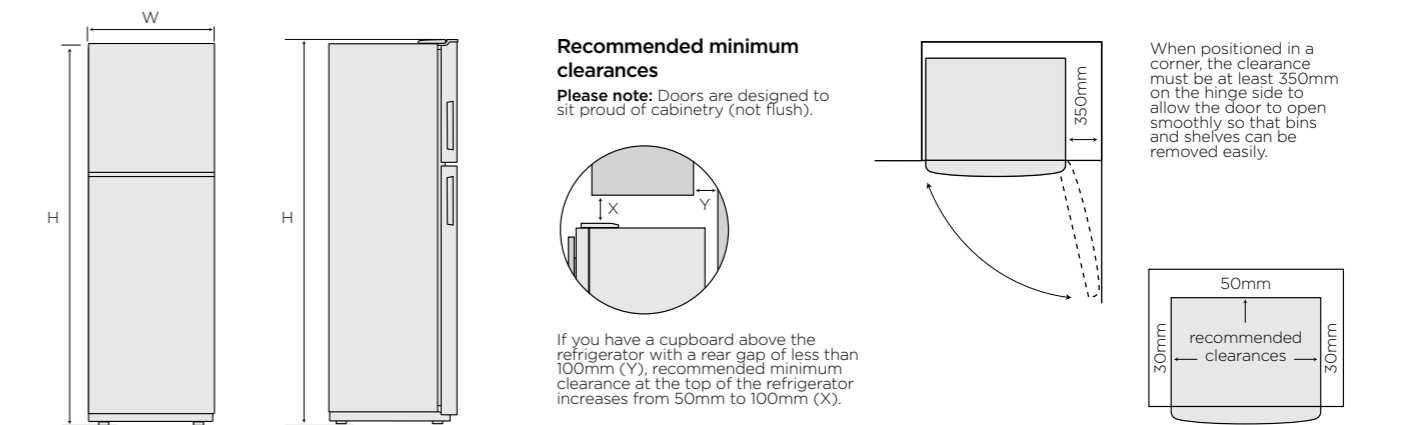

|                       | Model   | Door width (W) | Total depth (D) | Max height (H) | Cabinet width (W1) | Cabinet depth (D1) | Depth door open (D2) |
|-----------------------|---------|----------------|-----------------|----------------|--------------------|--------------------|----------------------|
| Large bottom mounts   | WBE5300 | 796            | 723             | 1725           | 790                | 641                | 1457                 |
|                       | WBE5304 | 796            | 769             | 1725           | 790                | 641                | 1457                 |
|                       | WBE4500 | 699            | 723             | 1725           | 693                | 641                | 1360                 |
|                       | WBE4504 | 699            | 769             | 1725           | 693                | 641                | 1360                 |
|                       | WBE4302 | 699            | 723             | 1725           | 693                | 641                | 1360                 |
| Compact bottom mounts | WBB3400 | 598            | 650             | 1756           | 595                | 575                | 1199                 |
|                       | WBB3100 | 598            | 650             | 1650           | 595                | 575                | 1199                 |

|                    | Model   | Door width (W) | Total depth (D) | Max height (H) | Cabinet width (W1) | Cabinet depth (D1) | Depth door open (D2) |
|--------------------|---------|----------------|-----------------|----------------|--------------------|--------------------|----------------------|
| Large top mounts   | WTB5404 | 796            | 769             | 1725           | 790                | 641                | 1457                 |
|                    | WTB5400 | 796            | 723             | 1725           | 790                | 641                | 1457                 |
|                    | WTB4604 | 699            | 769             | 1725           | 693                | 641                | 1360                 |
| Compact top mounts | WTB3400 | 598            | 650             | 1756           | 595                | 575                | 1199                 |
|                    | WTB3100 | 598            | 650             | 1650           | 595                | 575                | 1199                 |
|                    | WTB2800 | 540            | 615             | 1605           | 540                | 540                | 1108                 |
|                    | WTB2500 | 540            | 615             | 1470           | 540                | 540                | 1108                 |
|                    | WTB2300 | 540            | 615             | 1405           | 540                | 540                | 1108                 |

† Refer to the product information on the back page of this brochure. For information on installation of integration kits for top mounts, bottom mounts and pigeon pair models, please refer to westinghouse.com.au

† Refer to the product information on the back page of this brochure. For information on installation of integration kits for top mounts, bottom mounts and pigeon pair models, please refer to westinghouse.com.au



For more information on all Westinghouse appliances, or for dimension and installation information, call into your retailer, phone or email our customer care team or visit our website:

#### AUSTRALIA

phone: 13 13 49

email: [customercare@electrolux.com.au](mailto:customercare@electrolux.com.au)

web: [westinghouse.com.au](http://westinghouse.com.au)

#### NEW ZEALAND

phone: 0800 10 66 10

email: [customercare@electrolux.co.nz](mailto:customercare@electrolux.co.nz)

web: [westinghouse.co.nz](http://westinghouse.co.nz)



We invite you to follow Westinghouse appliances and get involved in the conversation.

#### Warranty

Electrolux Home Products Pty Ltd and Electrolux (NZ) Limited (collectively Electrolux) warrants that for domestic applications the Appliances featured in this brochure are free from defects in materials and workmanship for 2 years, an additional 3 year warranty is also provided for the sealed refrigeration system, and warrants that for featured accessories a period of 12 months, following the date of original purchase and subject to the conditions set out in the warranty card accompanying the product when purchased. This warranty is in addition to the other rights and warranties you may have under the Australian Consumer Law (ACL) and Electrolux will at all times comply with its obligations at law including the ACL. For New Zealand customers Electrolux will at all times comply with its obligations pursuant to law including the Consumer Guarantees Act, the Sale of Goods Act and the Fair Trading Act. Where appliances are purchased in NZ for commercial purposes the Consumer Guarantees Act does not apply.

#### † Product information

The descriptors and illustrations in this publication apply to the specific products and models described as at the date of issue. Under our policy of continuous product development, product specifications may change without notice. Prospective purchasers should therefore check with their retailer to ensure this publication correctly describes the products that are being offered for sale. All information supplied is to be used for general reference purposes only and is on the understanding that Electrolux will not be liable for any loss, liability or damage of whatever kind arising as a result of reliance on such information. Electrolux will at all times comply with its obligations pursuant to law. Colours of products illustrated are as close as printing limitations allow.

FlexSpace™, FlexStor, FamilySafe, FlexFresh™, SpillSafe and StoreSafe™ are used by Electrolux Home Products Pty Ltd.

Ⓜ and WESTINGHOUSE are trademarks of Westinghouse Electric Corporation. Used under license by Electrolux Home Products Pty Ltd. All Rights Reserved.

© 2022 Electrolux Home Products Pty Ltd. ABN 51 004 762 341 W\_BRO\_Fridge\_Feb22