

**Enjoy peace of mind.
Register your appliance today.**

Stay updated on better living services,
safety notices and shop for accessories.

1. **Open the camera app on your smartphone and point at the QR code to scan**



Product Registration QR code
is located on the front of the door
or internal side wall of your fridge.

2. **Tap the notification or link to open the registration form**
3. **Complete your details and enjoy peace of mind**

**WTB2300, WTB2500,
WTB2800, WTB3100,
WTB3400, WBB3100,
WBB3400**

REFRIGERATION

CONTENTS

1. SAFETY INFORMATION.....	3
2. DESCRIPTION OF THE APPLIANCE	5
3. TEMPERATURE CONTROL	8
4. INSTALLING YOUR NEW APPLIANCE	9
5. USING YOUR REFRIGERATOR.....	11
6. CLEANING YOUR REFRIGERATOR.....	13
7. FOOD STORAGE GUIDE.....	14
8. TROUBLESHOOTING.....	15
9. NOISES	17

WE'RE THINKING OF YOU

Thank you for choosing Westinghouse. We have designed this product to make your life simpler and deliver impeccable performance for many years. Please spend a few minutes reading this document to get the best from your new Westinghouse appliance.

Visit our website to:



Get usage advice or service information:
www.westinghouse.com



Register your product for better service:
www.westinghouse.com/support/register-warranty



Buy Accessories, Consumables and Original spare parts for your appliance:
www.westinghouse/shop

CUSTOMER CARE AND SERVICE

Always use original spare parts.

When contacting our Authorised Service Centre, ensure that you have the following data available: Model, PNC, Serial Number.

The information can be found on the rating plate.

 Warning / Caution-Safety information.

 General information and tips.

 Environmental information.

Subject to change without notice.

1. SAFETY INFORMATION

Note: You must read these warnings carefully before installing or using the refrigerator. If you need assistance, contact your customer care centre. The manufacturer will not accept liability, should these instructions or any other safety instructions incorporated in this book be ignored.



WARNING

- It is essential the electric outlet is properly earthed to ground. Consult a qualified electrician if you are unsure.
- Do not use electrical appliances inside the food storage compartments of the appliance, unless they are of the type recommended by the manufacturer.
- Unplug the refrigerator before cleaning or moving it to avoid electric shock.
- Never unplug the refrigerator by pulling the electrical cord as this may damage it. Grip the plug firmly and pull straight out.
- If the power cord is damaged, it must be replaced by the manufacturer, its service agent or similarly qualified persons in order to avoid a hazard.
- Don't use a steam cleaner. If live components come into contact with condensing steam, they may short-circuit or cause an electric shock.
- Do not store explosive substances such as aerosol cans with a flammable propellant this appliance. If pressurised aerosol containers bear the word 'flammable' and/or a small flame symbol, do not store them inside any refrigerator or freezer. If you do so you may cause an explosion.
- Do not damage the refrigerant circuit.
- This appliance contains insulation formed with flammable blowing gases. Avoid safety hazards by carefully disposing of this appliance.
- If you wish to discard this refrigerator, please contact your local authorities and ask for the correct method of disposal.
- When you dispose of your old refrigerators and freezers, remove any doors. Children can suffocate if they get trapped inside.
- When positioning the appliance, ensure the supply cord is not trapped or damaged.
- Do not locate multiple portable socket-outlets or portable power supplies at the rear of the appliance.



WARNING R600a refrigerant warning



This appliance contains flammable R600a refrigerant. Avoid safety hazards by carefully installing, handling, servicing and disposing of this appliance.

- Ensure that the tubing of the refrigerant circuit is not damaged during transportation and installation.
- Leaking refrigerant may cause eye injuries or ignite.
- The room for installing appliance must be at least 1m³ per 8g of refrigerant. The amount of refrigerant in the appliance can be found on the rating plate inside the appliance.
- If you are unsure of the refrigerant check the rating plate inside the refrigerator compartment.
- It is hazardous for anyone other than an Authorised Service Person to service this appliance. In Queensland Australia the Authorisation Service Person MUST hold a Gas Work Authorisation for hydrocarbon refrigerants to carry out servicing or repairs which involve the removal of covers.
- Keep ventilation openings in the appliance enclosure or in the built-in structure, clear of obstruction.
- Do not use mechanical devices or other means to accelerate the defrosting process, other than those recommended by the manufacturer.



WARNING Stable Footing

When your refrigerator is in place, you need to stabilise it. Lift the front of the refrigerator to take the weight off each stability foot and make small quarter turns to each foot until it is in firm contact with the floor. If you intend to move the refrigerator, remember to wind up each foot so that you can move it freely. Repeat the process of the foot adjustment once you have settled on the new location of the refrigerator.

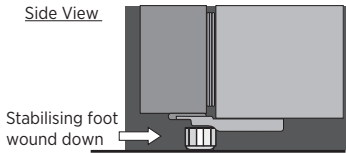

GENERAL WARNINGS

Read the following carefully to avoid damage or injury. It is important to use your refrigerator safely. Check these safety points before using your refrigerator.

- The appliance must be plugged into its own dedicated electrical outlet.
- The plug must be accessible when the refrigerator is in position.
- It is essential the powerpoint is properly earthed to ground. Consult a qualified electrician if you are unsure.
- Don't use extension cords or adapter plugs with this refrigerator.
- If the supply cord is damaged, it must be replaced by the manufacturer, its service agent or similarly qualified persons in order to avoid a hazard.
- Unplug the appliance before cleaning and before changing the light bulb (when fitted) to avoid electric shock.
- Never unplug the refrigerator by pulling the electrical cord as this may damage it. Grip the plug firmly and pull straight out.
- Choose a location for your refrigerator that isn't too cold. The ambient room temperature should be above 10°C.
- Stand your refrigerator in a dry place avoid areas of high moisture or humidity.
- Don't put the refrigerator in frosty or unprotected areas like a garage or on the verandah.
- Don't plug your refrigerator into a timer fitted to the powerpoint.
- Do not put the refrigerator in direct sunlight, near stoves, fires or heaters.
- Do not put the refrigerator on an uneven surface.
- Do not store flammable materials on or under the appliance, e.g. aerosols.
- Do not store explosive substances such as aerosol cans with a flammable propellant in this appliance.
- Never store fizzy drinks in the freezer compartment.
- Never try to repair the refrigerator yourself, only use a qualified or authorised service person for repairs.
- Never use electric heaters or dryers to defrost the freezer because you can receive an electric shock

- When transporting and installing the refrigerator, care should be taken to ensure that no parts of the refrigerating circuit are damaged.
- Keep ventilation openings in the appliance enclosure or in the built-in structure clear of obstruction.
- When installed correctly, your refrigerator should:
 - Have adequate space at the back and sides for air circulation.
 - Be vertically aligned to the surrounding cupboards.
 - Have doors that will self-close from a partially open position.
- The appliance is not to be used by persons (including children) with reduced physical, sensory or mental capabilities, or lack of experience and knowledge, unless they have been given supervision or instruction.
- Children being supervised not to play with the appliance.

NOTE: You must read these warnings carefully before installing or using the refrigerator. If you need assistance, contact your Customer Care Department. The manufacturer will not accept liability, should these instructions or any other safety instructions incorporated in this book be ignored.



Environmental information.

This appliance is intended to be used in household and similar applications such as,

- The kitchen areas in shops, offices and other working environments;
- Farm house and by clients in hotels, motels and other residential type environments;
- Bed and breakfast type environments;
- Catering and similar non-retail applications;

2. DESCRIPTION OF THE APPLIANCE

TOP MOUNT REFRIGERATOR FEATURES

- WTB2300
- WTB2500
- WTB2800

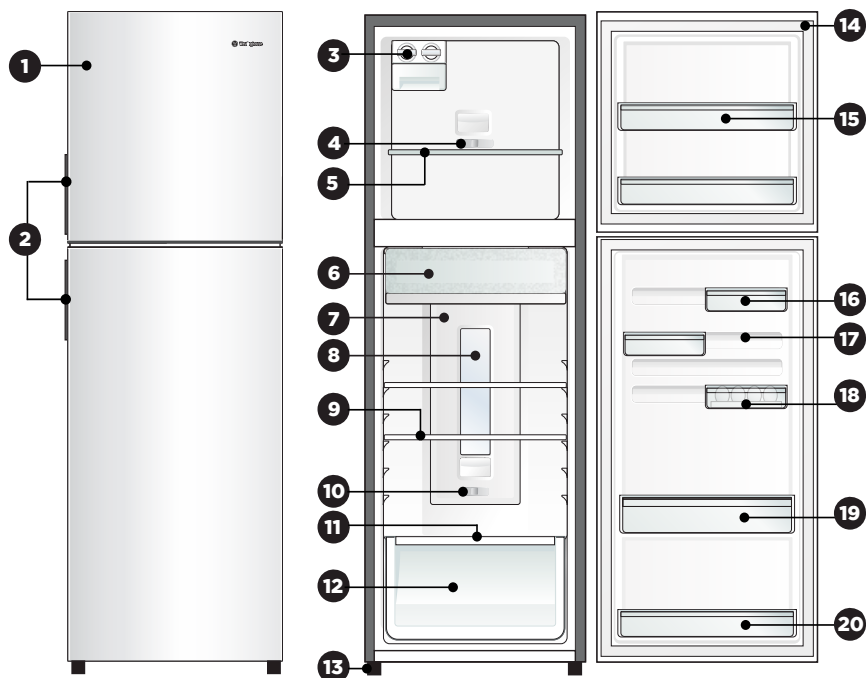

The details of the refrigerator feature:

- | | |
|--|----------------------------------|
| 1 Door | 11 Humidity Slide Control |
| 2 Door Handle | 12 Crisper |
| 3 Twist Ice and Serve | 13 Adjustable Feet |
| 4 Temperature Control (Freezer) | 14 Gaskets |
| 5 Freezer Shelf | 15 Freezer Door Bins |
| 6 Chiller Compartment | 16 Door Bins |
| 7 Multiflow | 17 Slide Rails |
| 8 Refrigerator Light | 18 Egg Tray |
| 9 Adjustable Glass Shelves | 19 Door Bin Upper |
| 10 Temperature Control (Refrigerator) | 20 Bottle Door Bins |

TOP MOUNT REFRIGERATOR FEATURES

- WTB3100
- WTB3400

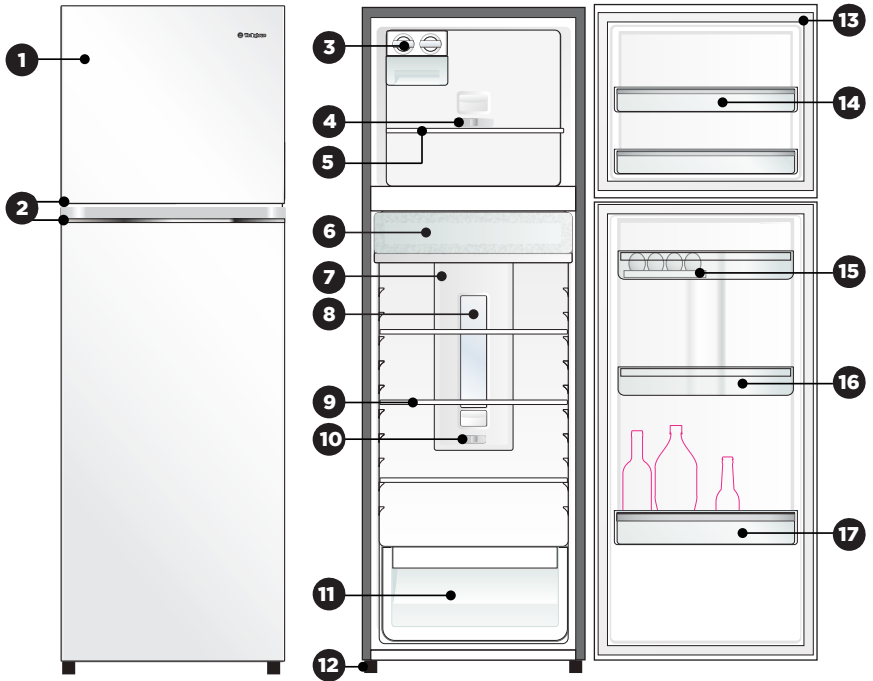

The details of the refrigerator feature:

- | | |
|---------------------------------------|----------------------|
| 1 Door | 11 Sealed Crisper |
| 2 Door Handle | 12 Adjustable Feet |
| 3 Twist Ice and Serve | 13 Gaskets |
| 4 Temperature Control (Freezer) | 14 Freezer Door Bins |
| 5 Freezer Shelf | 15 Egg Tray |
| 6 Chiller Compartment | 16 Door Bin Upper |
| 7 Multiflow | 17 Bottle Door Bins |
| 8 Refrigerator Light | |
| 9 Adjustable Glass Shelves | |
| 10 Temperature Control (Refrigerator) | |

BOTTOM MOUNT REFRIGERATOR FEATURES

- WBB3100
- WBB3400

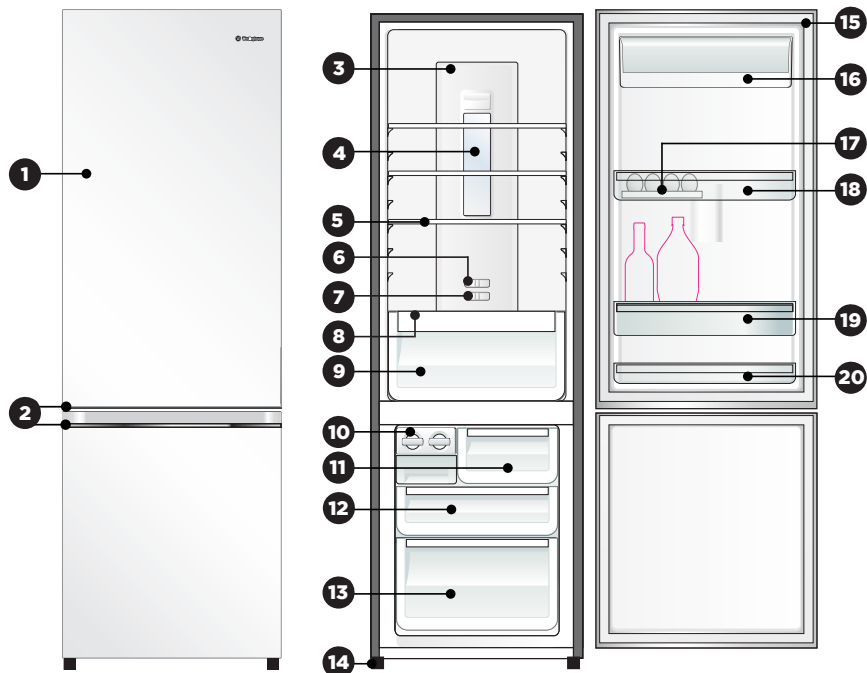

The details of the refrigerator feature:

- | | |
|---|---------------------------------|
| 1 Door | 11 Drawer Meat Box |
| 2 Door Handle | 12 Drawer Middle Freezer |
| 3 Multiflow | 13 Drawer Lower |
| 4 Refrigerator Light | 14 Adjustable Feet |
| 5 Adjustable Glass Shelves | 15 Gaskets |
| 6 Temperature Control (Refrigerator) | 16 Door Bin Dairy |
| 7 Temperature Control (Freezer) | 17 Egg Tray |
| 8 Humidity Slide Control | 18 Door Bin |
| 9 Crisper | 19 Bottle Door Bins |
| 10 Twist Ice and Serve | 20 Small Door Bins |

3. TEMPERATURE CONTROL

Set the temperature by using the slide temperature controls, refer to the relevant instruction for Bottom mount freezer or Top mount freezer models shown in this section. When you first turn on the refrigerator, set both the refrigerator and freezer temperature control to MID.



IMPORTANT

Changing settings

When you change the temperature settings, make small adjustments and wait 24 hours before assessing whether you need to make any further changes.

3.1 Top mount models

Top mount refrigerator temperature adjustment

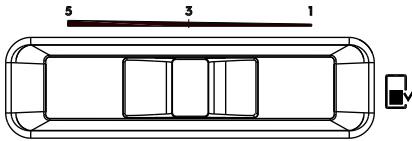

1. Select the refrigerator control.
2. Slide the control to the left to set Colder.
3. Slide the control to the right to set Less Cold.

Top mount freezer temperature adjustment

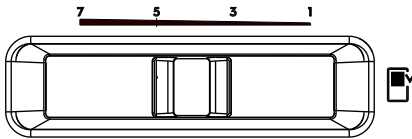

1. Select the freezer control.
2. Slide the control to the left to set Colder.
3. Slide the control to the right to set Less Cold.

3.2 Bottom mount models

Bottom mount refrigerator temperature adjustment

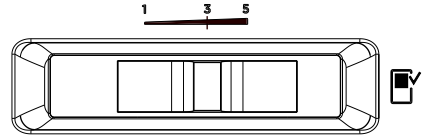

1. Select the refrigerator control.
2. Slide the control to the right to set Colder.
3. Slide the control to the left to set Less Cold.

Bottom mount freezer temperature adjustment

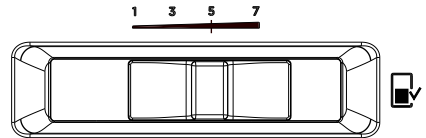

1. Select the freezer control.
2. Slide the control to the right to set Colder.
3. Slide the control to the left to set Less Cold.

Recommended Freezer Setting

Room Temp.	Setting
Below 15°	7
Above 15°	5

Only install refrigerator indoors where the room temperature is above 10°



IMPORTANT

Setting the freezer temperature to the lowest is not recommended for normal or very hot climate condition as this will limit the cooling capacity to other sections of the refrigerator. In a very cold climate, the freezer will need to be set colder.

4. INSTALLING YOUR NEW APPLIANCE

Unpacking



ENVIRONMENT

Most of the packing materials are recyclable. Please dispose of those materials through your local recycling depot or by placing them in appropriate collection containers.

Important – check for any damages or marks. If you find the refrigerator is damaged or marked, you must report it within 7 days should you wish to claim for damage/marks under the manufacturer's warranty. This does not affect your statutory rights.

Clean your refrigerator thoroughly following the instructions in the "Cleaning" section and wipe off any dust that has accumulated during shipping.

Locating the refrigerator



CAUTION

Automatic aerosol systems (such as insect control) should not be located adjacent to the product as the spray may cause long term damage to the external plastics of the appliance.

Do not put the refrigerator in a location that is too cold or is unprotected, for example in a garage or on a veranda. The ambient temperature should be above 10°C.

Put the refrigerator in a dry place avoiding areas of high moisture or humidity.

Ensure the refrigerator is located on an even surface.

Adequate ventilation around your refrigerator

The diagram below shows the recommended airspace to allow for ventilation of your refrigerator.

- Allow a minimum of 30mm clearance on both sides of the refrigerator.
- Allow 50mm clearance at the back of the refrigerator.
- Allow a minimum of 10mm clearance above the hinge cover.
- If you do not have a cupboard with allowance for air flow above the refrigerator, the recommended clearance area on top increases to 90 mm.
- When positioned in a corner area, spacing of at 350mm on the hinge side will allow the doors to open enough to enable the removal of bins and shelves.

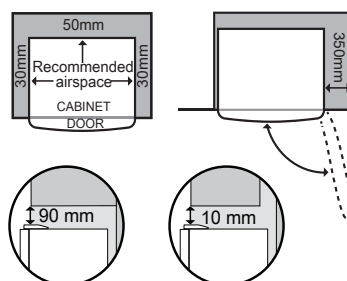

NOTE: In installation where both sides and the rear of the refrigerator are not enclosed by cabinetry e.g. the refrigerator is placed against a wall, the clearance between the rear of refrigerator and the wall should not be greater than 75mm.

Your refrigerator uses energy efficient components that may produce different noises (Refer "Noises" page for examples) to your old refrigerator. Occasionally a gurgling sound of refrigerator flowing or the sound of parts expanding and contracting can be heard. These noises are quite normal.

Installing your refrigerator

Allow the following clearances for ease of installation, proper air circulation, and plumbing and electrical connections:

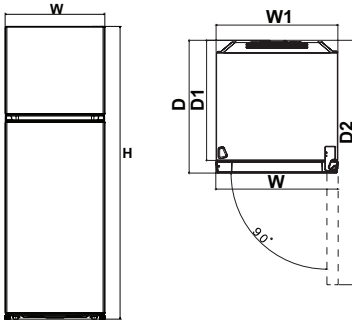

MODEL	MAX DOOR HEIGHT (H)	DOOR WIDTH (W)	CABINET WIDTH (W1)	TOTAL DEPTH (D)	CABINET DEPTH (D1)	DEPTH DOOR OPEN (D2)
WTB2300	1405	540	540	626	551	1110
WTB2500	1470	540	540	626	551	1110
WTB2800	1605	540	540	626	551	1110
WTB3100	1646	598	595	657	586	1199
WTB3400	1756	598	595	647	586	1199
WBB3100	1646	598	595	647	586	1200
WBB3400	1756	598	595	647	587	1200

1. Roll the refrigerator into place, the rollers are designed for forward or backward movement only, they are not castors. Moving the refrigerator sideways may damage your floor and the rollers. Before moving your refrigerator, ensure height adjusting nut and the stability foot are fully wound up off the floor.
2. Wind the height adjusting nut under door hinge down until the refrigerator is tilted back by 10mm (see diagram).

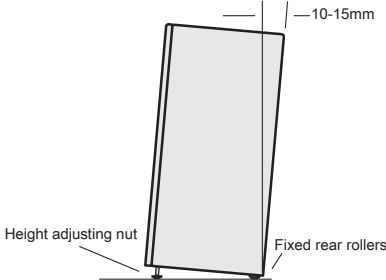

3. Wind the height adjusting nut on the handle side down until the refrigerator is level and stable. If you have difficulty winding the nut or height adjusting foot down, have someone tilt the refrigerator back so you have better access.

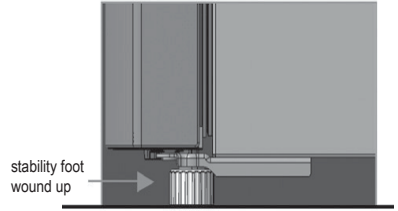

4. Check the alignment of the refrigerator to the surrounding cupboards to see if it is level. You can adjust the level as detailed in step 2 and 3.

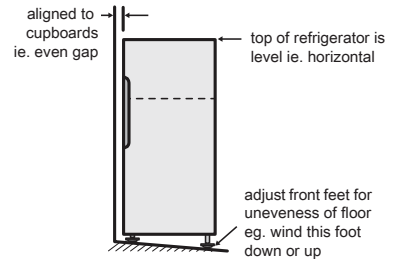

5. USING YOUR REFRIGERATOR

Refrigerators work by transferring heat from the food inside to the outside air. This operation makes the back and sides of the refrigerator feel warm or even hot particularly at start-up and on warm days – this is normal.

Avoid placing food against the air vents in the refrigerator as it affects efficient circulation. If the door is opened frequently, a light frosting will occasionally occur on the freezer's interior. This is normal and will clear after a few days. If the freezer door is accidentally kept open, a heavy frost will coat the inside walls and should be removed.

Your new refrigerator uses a high-speed compressor, along with other energy-efficient components, which may make unusual sounds and be more noticeable at night and quieter times. These sounds simply indicate your refrigerator is working how it should. They include:

- Compressor running noises; modern, high efficiency compressors run much faster than older models.
- Air movement noise from the small fan motor;
- A gurgling sound, similar to water boiling;
- A popping noise, heard during automatic defrosting; and
- A clicking noise, prior to compressor start-up. Further details can be found in the Troubleshooting Guide.

i For bottom mount refrigerators (where freezer is below the fresh food compartment):

- Ensure all freezer drawer and shelves are pushed back completely to prevent them from keeping the door open.

i For top mount refrigerators (where freezer is on top the fresh food compartment):

- Don't place food forward of the ribs on the freezer floor, as it will obstruct the door from closing

5.1 USING AND REMOVING FEATURES

5.1.1 Glass Shelves

To remove the shelves, gently pull them forward until the shelf comes clear of the shelf guides.

To return the shelf, make sure there is nothing behind that may obstruct movement. Gently push the shelf, into the cabinet and back into position.

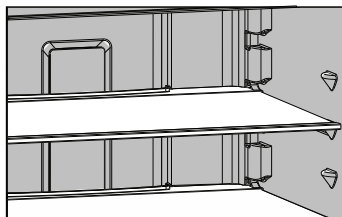

5.1.2 Crisper bin

Storing Vegetables Use the crisper bin to store vegetables, fruits or small items. You can adjust the humidity inside the bin by sliding the humidity control.

Model WTB23**, WTB25**, WBB31** and WBB34** have humidity slide control.

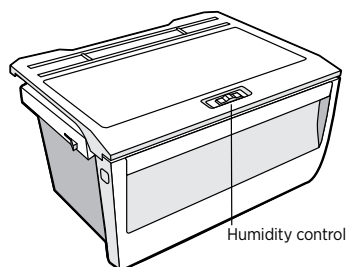

5.1.3 Crisper Drawer

Crisper drawer is designed for storing fruits, vegetables, and other fresh produce.

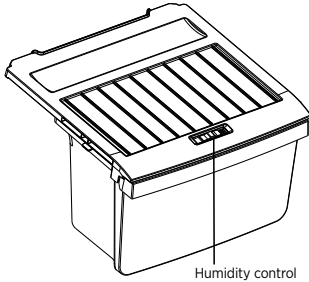

- To empty food from the crisper. On some models it will be necessary to remove the bottle storage bins.
- Remove the crisper by pulling forward, then up and forward again.
- For top mount models, remove the crisper shelf by lifting the catches on the left and right underside of the shelf and pulling the shelf forward.

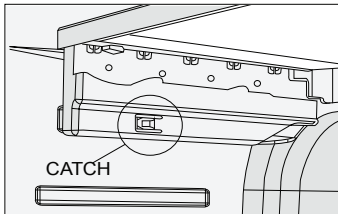

5.1.4 Door storage bins
Both the refrigerator and freezer have door storage bins.

You can adjust the refrigerator bins to meet different storage needs. All the door bins are completely removable for cleaning. If you want to remove or adjust a bin, lift and unlock from lugs to remove. To replace, lift up and push bin down until the support lugs lock it in place.

Door storage bins for model : WTB23** , WTB25** , WTB28**

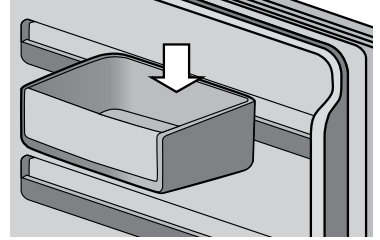

Door storage bins for model : WTB31** , WTB34** , WBB31** , WBB34**

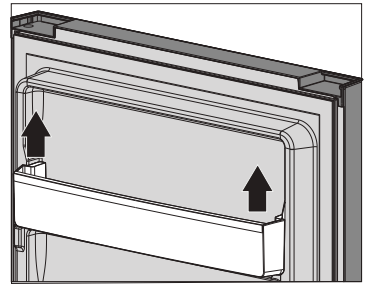

5.1.5 Door alarm

If the refrigerator door is left open longer than two minutes, a buzzer will sound. Re-set the alarm by pressing the light switch.

5.1.6 LED lighting

Your refrigerator is fitted with long life LED lighting. In the unlikely event the LED lights should ever fail, then the LED lights need to be serviced by a qualified technician. Refer to page 15 for contact details.



CAUTION

LED lighting

Your appliance is fitted with long life LED lighting. In the unlikely event the LED lights should fail, then the LED lights should be serviced by the manufacturer.

Refer to the warranty page for contact details.

6. CLEANING YOUR REFRIGERATOR



WARNING

BEFORE CLEANING: Turn the refrigerator off at the electric outlet and unplug the cord to prevent any chance of electrocuting yourself.

Doors and exterior (white and silver): You should only clean the doors with lukewarm soapy water and a soft cloth.



CAUTION

Never use stainless steel cleaners, abrasive pads or other cleaners that will scratch the surface. Damage to the appliance after delivery is not covered by your warranty.

Interior

Clean the inside of your refrigerator regularly with a soft cloth, unscented mild soap and lukewarm water.

Thoroughly dry all surfaces and removable parts and avoid getting water on the controls. Replace removable parts, plug power cord in and switch the power on before returning the food.

Door seals

Always keep door seals clean by washing them with a mild detergent and warm water, followed by a thorough drying.

Sticky food and drink can cause seals to stick to the cabinet and tear when you open the door.



CAUTION

Never use hot water, solvents, commercial kitchen cleaners, aerosol cleaners, metal polishes, caustic or abrasive cleaners, or scourers to clean your refrigerator. Many commercially available cleaning products and detergents contain solvents that will damage your refrigerator. Use only a soft cloth with an unscented mild soap and lukewarm water.

To clean a crisper or freezer bin with telescopic extension slides, simply wipe with a damp cloth and warm soapy water. Never immerse the cover in water, as this could affect the operation of the slide.

Switching off your refrigerator

If you switch off your refrigerator for an extended period, follow these steps to reduce the chances of mould:

1. Remove all food.
2. Remove the power plug from the electric outlet.
3. Thoroughly clean and dry the interior.
4. Ensure that all the doors are wedged open slightly for air circulation.

7. FOOD STORAGE GUIDE

CATEGORY	PRODUCT	RECOMMENDED STORAGE TIMES FOR FRESH FOODS *		STORAGE TIPS
		REFRIGERATOR	FREEZER	
MEAT	Sausages and Mince	1-2 Days	2-3 Months	Keep cold meat at the back of the refrigerator where it is coldest. Plastic can cause meat to sweat if stored in refrigerator for more than a day. Roast can take up to 48 hours to defrost properly, transfer frozen roast to the refrigerator 2 days before use.
	Chops and Steak	3-4 Days	4-6 Months	
	Cold Meats	3-5 Days	4-6 Months	
	Roasts	3-5 Days	12 Months	
POULTRY	Chicken	1-2 Days	2 Months	If poultry takes on a smell or colour you are unsure about it is best to throw it out. Whole eggs are not suitable for freezing, slightly beaten eggs may be frozen for four months.
	Roast Chicken	3-5 Days	12 Months	
	Eggs	6 Weeks	Not Suitable	
SEAFOOD	Whole fish and fillets	2-3 Days	2 Months	Store in an airtight container or foil. Never freeze prawns in salty water as this will dehydrate the flesh.
	Lobster and Crab	1-2 Days	2 Months	
	Prawns	1-2 Days	2 Months	
DAIRY	Milk	Until Expiry Date	Not Suitable	If dairy takes on a smell or colour and you are unsure about it, it is best to throw it out.
	Yoghurt	7- 10 Days	Not Suitable	
	Hard Cheeses	2 Weeks – 2 Months	2 Months (Grated)	Depending on the variety hard cheese can last from 2 weeks to 2 months. * Texture may change depending of the type of soft cheese
	Soft Cheeses	1-2 Weeks	Not Suitable	
	Butter	8 Weeks	12 Months	
FRUIT & VEGETABLES	Every fruit and vegetable has a different shelf life. Some stay fresh for a couple of days e.g. beans, others can last for a couple of months e.g. onions.	8-12 Months When freezing chop and blanch in small portions.	Keep vegetables in the crisper and away from the air vents to avoid freezing. If you wash fruit and vegetables before storing them make sure they are dry or wrap in absorbent paper before storing in the refrigerator as this can make them susceptible to rotting. Try to keep fruit and vegetables separated as fruits that give off high levels of ethylene (the ripening agent) can prematurely ripen and spoil surrounding vegetables	



IMPORTANT

* Please note, use this information as a guide only, actual storage times will vary depending on how you use your refrigerator.

8. TROUBLESHOOTING

Appliance does not operate at desired temperature

In a modern frost free refrigerator / freezer, cold air is circulated around the various compartments through air vents using a high efficiency fan.

CONCERN	WHAT TO DO
Refrigerator is too warm.	<ul style="list-style-type: none"> • Ensure food is allowed to cool before placing inside the refrigerator. • Ensure the appliance is set up as per instructions. • Ensure that contents are not obstructing the cooling vents. • Ensure the door is not held open or is being opened too frequently.
Freezer is too warm.	<ul style="list-style-type: none"> • Adjust temperature to a colder setting. • Ensure food is allowed to cool before placing inside the freezer. • Ensure the appliance is set up as per instructions. • Ensure that contents are not obstructing the cooling vents. • Ensure the door is not held open or is being opened too frequently.
Food is freezing in the refrigerator.	<ul style="list-style-type: none"> • Adjust temperature to a warmer setting. • Ensure that fruit and vegetables are stored in the crisper. Items with a high water content should not be placed near the cooling vents.
Unable to change temperature settings.	<ul style="list-style-type: none"> • Refer to function guide in Controlling Your Refrigerator. • Ensure that user interface is in "awake" mode before trying to adjust temperature settings.

Appliance noise

Your new refrigerator may make sounds that your old one didn't make. Because the sounds are new to you, you might be concerned about them. Most of the new sounds are normal. Hard surfaces, like the floor, walls and cabinets, can make the sounds seem louder than they actually are. The following describes the kinds of sounds and what may be making them.

CONCERN	WHAT TO DO
Motor noise (compressor).	<p>Nothing. This is normal as your new refrigerator uses a variable speed compressor and fan that at start up and on warm days runs at a high speed to provide additional cooling.</p> <p>When less cooling is required the compressor and fan will run at a lower speed. Note that the compressor noise may seem louder at the start of the on cycle.</p>
A clicking noise heard just before the compressor starts.	Nothing. This is normal as your new refrigerator has an automatic switching action of the temperature control, turning the compressor on and off.
Occasional gurgling, similar to water boiling.	Nothing. As each refrigeration cycle ends, you may hear a gurgling sound due to the refrigerant flowing in your refrigerator system.
Airflow noise.	Nothing, this is normal as your new refrigerator uses high efficiency fans to circulate air. Fan speed and noise may increase during periods of heavy usage or hot weather.
Rattling and other noises.	<ul style="list-style-type: none"> • Ensure that the cabinet is level and stable, refer to Installation Instructions. • Check the surroundings of the appliance to ensure there is nothing touching or placed on top of the appliance. • Ensure that contents of the appliance are not placed in such a way that they are vibrating (such as bottles).

Refrigerator operation

CONCERN	WHAT TO DO
When your appliance is not operating	<ul style="list-style-type: none"> • Check that the power cord is plugged into the power outlet properly and that the outlet is switched on. • Try running another appliance from the same power outlet. If no power is coming out from the outlet, you may have a blown fuse or tripped your household power supply circuit. • Try adjusting the temperature control to a slightly colder position. • It is normal for the freezer fan to NOT operate during the automatic defrost cycle or for a short time after the refrigerator is turned on.
When there is refrigerator noise	<p>Your refrigerator uses energy efficient components that may produce different noises from your old refrigerator.</p> <p>Occasionally, a gurgling sound of the refrigerant flowing or the sound of parts contracting or expanding may be heard.</p> <p>These sounds are quite normal. If the refrigerator is rattling or making vibrating noises, check that it is level and adjust levelling foot.</p>
If there are odours inside the refrigerator	<ul style="list-style-type: none"> • The interior may need cleaning. • Some foods may produce strong odours and need to be tightly sealed.
If the temperature in the refrigerator is too warm	<ul style="list-style-type: none"> • Check that the refrigerator has enough clearance at the sides, back and top. Refer to 'Installing Your New Appliance' in this manual. • Refer to 'Temperature Control' section. • The door may have been opened for too long or too frequently. • Food containers or packaging may be holding the door.
If the temperature in the refrigerator is too cold	<ul style="list-style-type: none"> • Refer to 'Temperature Control' section. • Increase the temperature to avoid high energy consumption.

9. NOISES

Appliance noise

Your new refrigerator may make sounds that your old one didn't make. Because the sounds are new to you, you might be concerned about them. Most of the new sounds are normal. Hard surfaces, like the floor, walls and cabinets, can make the sounds seem louder than they actually are. The following describes the kinds of sounds and what may be making them."

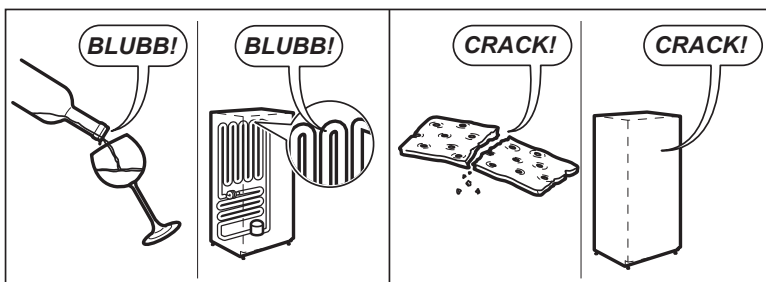
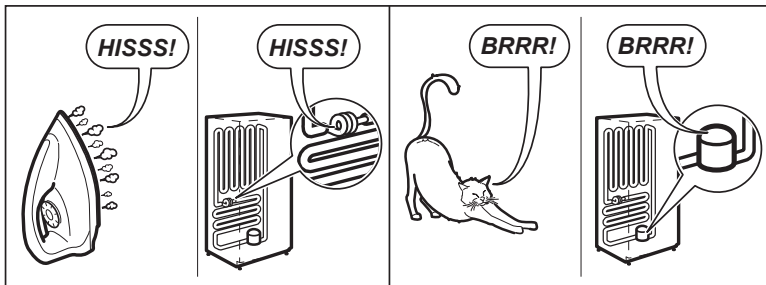
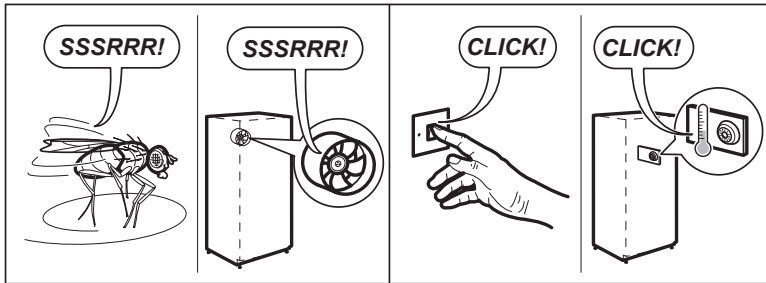
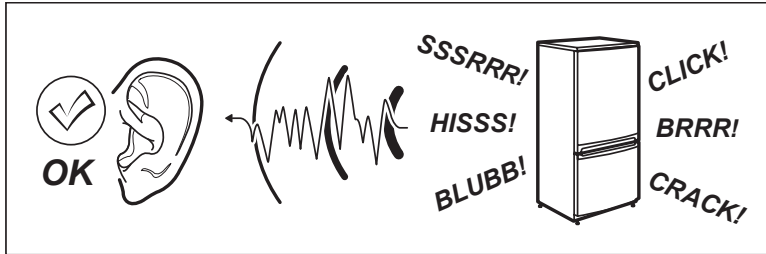

Electrolux Warranty

FOR SALES IN AUSTRALIA AND NEW ZEALAND
 APPLIANCE: WESTINGHOUSE REFRIGERATORS AND FREEZERS

This document sets out the terms and conditions of the product warranties for Westinghouse Appliances. It is an important document. Please keep it with your proof of purchase documents in a safe place for future reference should there be a manufacturing defect in your Appliance. This warranty is in addition to other rights you may have under the Australian Consumer Law.

1. In this warranty:

- (a) 'ACL' or 'Australian Consumer Law' means Schedule 2 to the Competition and Consumer Act 2010;
- (b) 'Appliance' means any Electrolux product purchased by you and accompanied by this document;
- (c) 'ASC' means Electrolux's authorised serviced centres;
- (d) 'Westinghouse' is the brand controlled by Electrolux Home Products Pty Ltd of 163 O'Riordan Street, Mascot NSW 2020, ABN 51 004 762 341 in respect of Appliances purchased in Australia and Electrolux (NZ) Limited (collectively "Electrolux") of 3-5 Niall Burgess Road, Mount Wellington, in respect of Appliances purchased in New Zealand;
- (e) 'Warranty Period' means the period specified in clause 3 of this warranty;
- (f) 'you' means the purchaser of the Appliance not having purchased the Appliance for re-sale, and 'your' has a corresponding meaning.

2. Application: This warranty only applies to new Appliances, purchased and used in Australia or New Zealand and is in addition to (and does not exclude, restrict, or modify in any way) other rights and remedies under a law which the Appliances or services relate, including any non-excludable statutory guarantees in Australia and New Zealand.

3. Warranty Period: Subject to these terms and conditions, this warranty continues for in Australia for a period of 24 months and in New Zealand for a period of 24 months, following the date of original purchase of the Appliance. Specific components are warranted against manufacturing defects in Australia and New Zealand for the periods listed below;

- Compressor – Further 3 years
- External Condenser – Further 3 years
- Evaporator – Further 3 years
- Drier – Further 3 years

4. Repair or replace warranty: During the Warranty Period, Electrolux or its ASC will, at no extra charge if your Appliance is readily accessible for service, without special equipment and subject to these terms and conditions, repair or replace any parts which it considers to be defective. Electrolux may, in its absolute discretion, choose whether the remedy offered for a valid warranty claim is repair or replacement. Electrolux or its ASC may use refurbished parts to repair your Appliance. You agree that any replaced Appliances or parts become the property of Electrolux.

5. Travel and transportation costs: Subject to clause 7, Electrolux will bear the reasonable cost of transportation, travel and delivery of the Appliance to and from Electrolux or its ASC. Travel and transportation will be arranged by Electrolux as part of any valid warranty claim.

6. Proof of purchase is required before you can make a claim under this warranty.

7. Exclusions: You may not make a claim under this warranty unless the defect claimed is due to faulty or defective parts or workmanship. This warranty does not cover:

- (a) light globes, batteries, filters or similar perishable parts;
- (b) parts and Appliances not supplied by Electrolux;
- (c) cosmetic damage which does not affect the operation of the Appliance;
- (d) damage to the Appliance caused by:
 - (i) negligence or accident;
 - (ii) misuse or abuse, including failure to properly maintain or service;
 - (iii) improper, negligent or faulty servicing or repair works done by anyone other than an Electrolux authorised repairer or ASC;
 - (iv) normal wear and tear;
 - (v) power surges, electrical storm damage or incorrect power supply;
 - (vi) incomplete or improper installation;
 - (vii) incorrect, improper or inappropriate operation;
 - (viii) insect or vermin infestation;
 - (ix) failure to comply with any additional instructions supplied with the Appliance;

In addition, Electrolux is not liable under this warranty if:

- (a) the Appliance has been, or Electrolux reasonably believes that the Appliance has been, used for purposes other than those for which the Appliance was intended, including where the Appliance has been used for any non-domestic purpose;
- (b) the Appliance is modified without authority from Electrolux in writing;
- (c) the Appliance's serial number or warranty seal has been removed or defaced.

8. How to claim under this warranty: To enquire about claiming under this warranty, please follow these steps:

- (a) carefully check the operating instructions, user manual and the terms of this warranty;
- (b) have the model and serial number of the Appliance available;
- (c) have the proof of purchase (e.g. an invoice) available;
- (d) telephone the numbers shown below.

9. Australia: For Appliances and services provided by Electrolux in Australia: Electrolux goods come with guarantees that cannot be excluded under the Australian Consumer Law. You are entitled to a replacement or refund for a major failure and for compensation for any other reasonably foreseeable loss or damage. You are also entitled to have the Appliance repaired or replaced if the Appliance fails to be of acceptable quality and the failure does not amount to a major failure. 'Acceptable quality' and 'major failure' have the same meaning as referred to in the ACL.

10. New Zealand: For Appliances and services provided by Electrolux in New Zealand, the Appliances come with a guarantee by Electrolux pursuant to the provisions of the Consumer Guarantees Act, the Sale of Goods Act and the Fair Trading Act. Where the Appliance was purchased in New Zealand for commercial purposes the Consumer Guarantee Act does not apply.

11. Confidentiality: You accept that if you make a warranty claim, Electrolux and its agents including ASC may exchange information in relation to you to enable Electrolux to meet its obligations under this warranty.

Important Notice

Before calling for service, please ensure that the steps listed in clause 8 above have been followed.

AUSTRALIA	FOR SERVICE or to find the address of your nearest authorised service centre in Australia PLEASE CALL 13 13 49 <small>For the cost of a local call</small>	FOR SPARE PARTS or to find the address of your nearest spare parts centre in Australia PLEASE CALL 13 13 50 <small>For the cost of a local call</small>
NEW ZEALAND	FOR SERVICE or to find the address of your nearest authorised service centre in New Zealand PLEASE CALL 0800 10 66 10	FOR SPARE PARTS or to find the address of your nearest spare parts centre in New Zealand PLEASE CALL 0800 10 66 20

For more information on all Westinghouse appliances, or for dimension and installation information, call into your retailer, phone or email our customer care team or visit our website:

AUSTRALIA

phone: 1300 363 640
fax: 1800 350 067
email: customercare@electrolux.com.au
web: westinghouse.com.au

NEW ZEALAND

phone: 0800 436 245
fax: 0800 225 088
email: customercare@electrolux.co.nz
web: westinghouse.co.nz

A12081686-A-362021

TOP SERVICE

Top Service encompasses the after sales service provided by The Electrolux Group to consumers including delivery, home service and spare parts.

 and WESTINGHOUSE are trademarks of Westinghouse Electric Corporation. Used under license. All Rights Reserved.