

DISHWASHER

WSF6606XA, WSF6606KXA

CONGRATULATIONS

Dear customer,

Congratulations on the purchase of your new Westinghouse dishwasher.

Before you use the dishwasher, we recommend that you read through the whole user manual which provides the description of the dishwasher and its functions.

To avoid the risks that are always present when you use an electrical appliance, it is important that the dishwasher is installed correctly and that you read the safety instructions carefully to avoid misuse and hazards.

We recommend that you keep this instruction booklet for future reference and pass it on to any future owners.

After unpacking the appliance, please check it is not damaged. If in doubt, do not use the appliance but contact your local Customer Care Centre.

For contact details, refer to the last page of this user manual.

Conditions of use

This appliance is intended to be used in household and similar applications such as:

- Staff kitchen areas in shops, offices and other working environments
- Farm houses
- By clients in hotels, motels and other residential type environments
- Bed and breakfast type environments

Please ensure you read the instruction manual fully before you call for service, or a full service fee could be applicable.

Record model and serial number here:

Model number:.....

Serial number:.....

PNC:.....

IMPORTANT INFORMATION THAT MAY IMPACT YOUR MANUFACTURER'S WARRANTY

Adherence to the directions for use in this manual is extremely important for health and safety. Failure to strictly adhere to the requirements in this manual may result in personal injury, property damage and affect your ability to make a claim under the Westinghouse manufacturer's warranty provided with your product. Products must be used, installed and operated in accordance with this manual. You may not be able to claim on the Westinghouse manufacturer's warranty in the event that your product fault is due to failure to adhere this manual.

CONTENTS

General warnings.....	3
Safety instructions.....	4
Product description.....	5
Technical specifications.....	5
Control panel.....	6
Control description.....	7
Programs.....	8
Settings.....	9
Hints and tips.....	9
Installation.....	10
Preparing for use.....	13
Loading.....	15
Maintenance and cleaning.....	19
Troubleshooting.....	20
Warranty.....	21

Please read the user manual carefully and store in a handy place for later reference.

The symbols you will see in this booklet have these meanings:



WARNING

This symbol indicates information concerning your personal safety.



CAUTION

This symbol indicates information on how to avoid damaging the appliance.



IMPORTANT

This symbol indicates tips and information about use of the appliance.



ENVIRONMENT

This symbol indicates tips and information about economical and ecological use of the appliance.

GENERAL WARNINGS

Please read the user manual carefully and store in a handy place for later reference. Pass the user manual on to possible new owners of the appliance.

Read the following carefully to avoid damage or injury.

Note: You must read these warnings carefully before installing or using the appliance. If you need assistance, contact your Customer Care Department. The manufacturer will not accept liability, should these instructions or any other safety instructions incorporated in this book be ignored.

Children and vulnerable people safety.



WARNING

Risk of injury or permanent disability.

This appliance can be used by children aged from 8 years and above and persons with reduced physical, sensory or mental capabilities or lack of experience and knowledge if they have been given supervision or instruction concerning use of the appliance in a safe way and understand the hazards involved.

- Do not let children play with the appliance.
- Keep all detergents away from children.
- Keep children and pets away from the appliance door when it is open.
- Cleaning and user maintenance shall not be made by children without supervision.



WARNING

It is important to use your appliance safely. Check these safety points before using your appliance.

General Safety

- Do not change the specification of this appliance.
- The operating water pressure (minimum and maximum) must be between 0.3 (0.03) / 10 (1.0) bar (MPa)
- Obey the maximum number of 15 place settings.
- If the supply cord is damaged, it must be replaced by the manufacturer, its Authorised Service Centre or similarly qualified persons in order to avoid a hazard.
- Put knives and cutlery with sharp points in the cutlery basket with the points down or in a horizontal position.
- Do not leave the appliance door open without supervision to prevent causing a trip hazard.
- Before maintenance, turn the appliance off and disconnect the plug from the mains.
- Do not use water spray and steam to clean the appliance.
- The appliance is to be connected to the water mains using the new supplied hose-sets. Old hose sets must not be reused.
- The ventilation openings in the base (if applicable) must not be obstructed.
- Some dishwasher detergents are strongly alkaline. They can be extremely dangerous if swallowed. Avoid contact with the skin and eyes and keep children away from the dishwasher when the door is open.
- Check that the detergent receptacle is empty after completion of the wash cycle.

Installation

- Remove all the packaging.
- Do not install or use a damaged appliance.
- Do not install or use the appliance where the temperature is less than 0°C.
- Obey the installation instruction supplied with the appliance.
- Make sure that the appliance is installed below and adjacent to safe structures.

SAFETY INSTRUCTIONS



WARNING

Risk of fire and electrical shock.

Electrical connection

- The appliance must be earthed.
- Make sure that the electrical information on the rating plate is the same as the power supply. If not, contact an electrician.
- Always use a correctly installed shockproof socket.
- Do not use multi-plug adapters and extension cables.
- Make sure not to cause damage to the mains plug and to the mains cable. Should the mains cable need to be replaced, this must be carried out by our Authorised Service Centre.
- Connect the mains plug to the mains socket only at the end of the installation. Make sure that there is access to the mains plug after the installation.
- Do not pull the mains cable to disconnect the appliance. Always pull the mains plug.

Water connection

- Make sure not to cause damage to the water hoses. Before you connect the appliance to new pipes or pipes not used for a long time, let the water flow until it is clean.
- The first time you use the appliance, make sure that there is no leakage.



WARNING

- Use the new water inlet hose supplied with your machine, do not use an old machine's hose.
- Run water through the new hose before connecting.

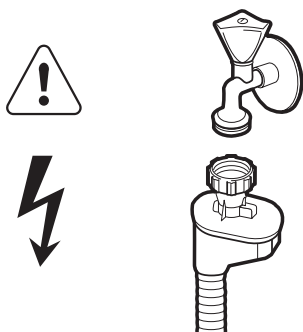

WARNING

Dangerous voltage

- If the water inlet hose is damaged, immediately disconnect the mains plug from the mains socket. Contact the Authorised Service Centre to replace the water inlet hose.

Use

- Do not sit or stand on the open door.
- Dishwasher detergents are dangerous. Obey the safety instructions on the detergent packaging.
- Do not drink and play with the water in the appliance.
- Do not remove the dishes from the appliance until the program is completed. There can be detergent on the dishes.
- The appliance can release hot steam if you open the door while a program operates.
- Do not put flammable products or items that are wet with flammable products in, near or on the appliance.



WARNING

Risk of injury or suffocation.

Disposal

- Disconnect the appliance from the mains supply.
- Cut off the mains cable and discard it.
- Remove the door catch to prevent children and pets to get closed in the appliance.

PRODUCT DESCRIPTION

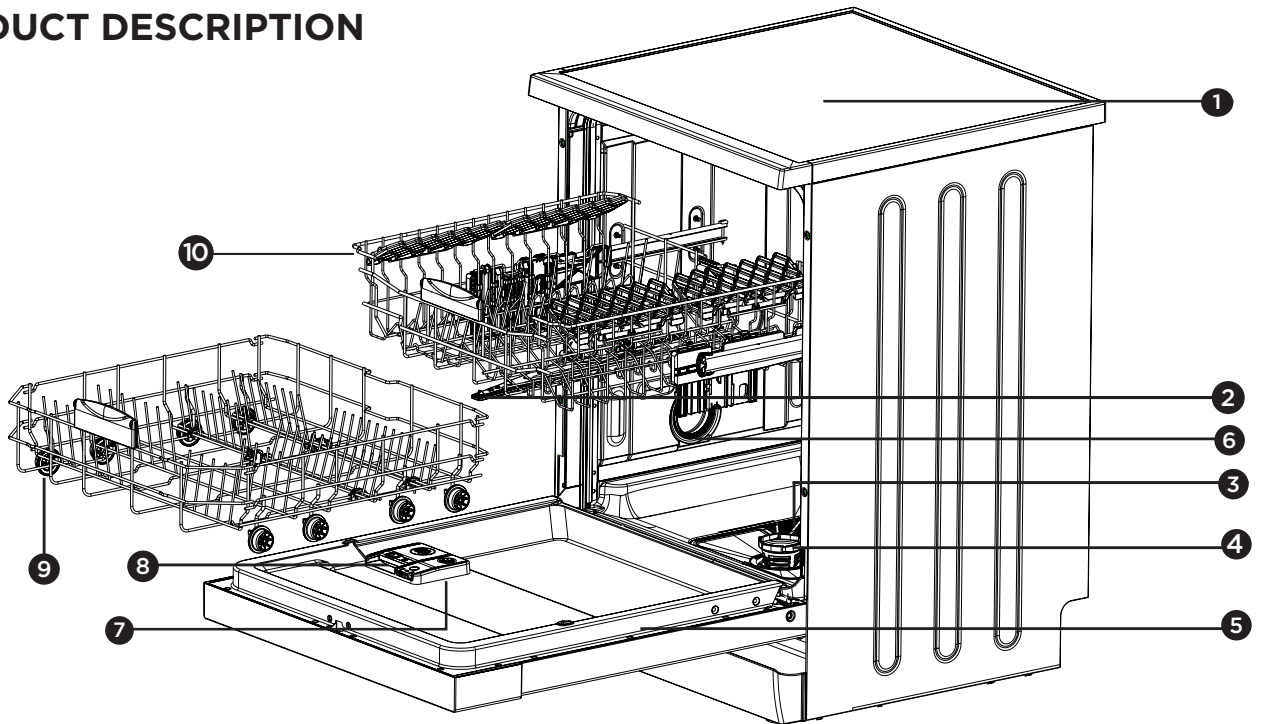

- 1 Worktop
- 2 Upper spray arm
- 3 Lower spray arm
- 4 Filters
- 5 Rating plate
- 6 Air vent
- 7 Rinse aid dispenser
- 8 Detergent dispenser
- 9 Lower basket
- 10 Upper basket
- 11 Super Active Drying

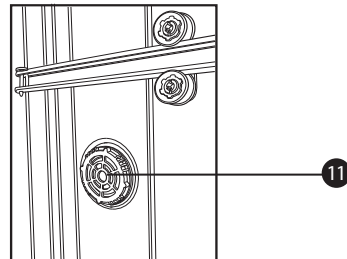

TECHNICAL SPECIFICATIONS

MODEL	WSF6606XA - built under	WSF6606KXA- built under
Capacity	15 place settings	15 place settings
Height	850mm	850mm
Height (without worktop)	820mm	820mm
Width	598mm	598mm
Depth	598mm	570mm
Net weight	56kg	56kg
Electricity input	220-240 V, 50 Hz	220-240 V, 50 Hz
Current	10 A	10 A
Total power	1900W	1900W
Water supply pressure	0.03 MPa (0,3 bar) – 1 MPa (10 bar)	0.03 MPa (0,3 bar) – 1 MPa (10 bar)
Water supply	hot or cold water max. 60°C 10L/min	hot or cold water max. 60°C 10L/min

CONTROL PANEL

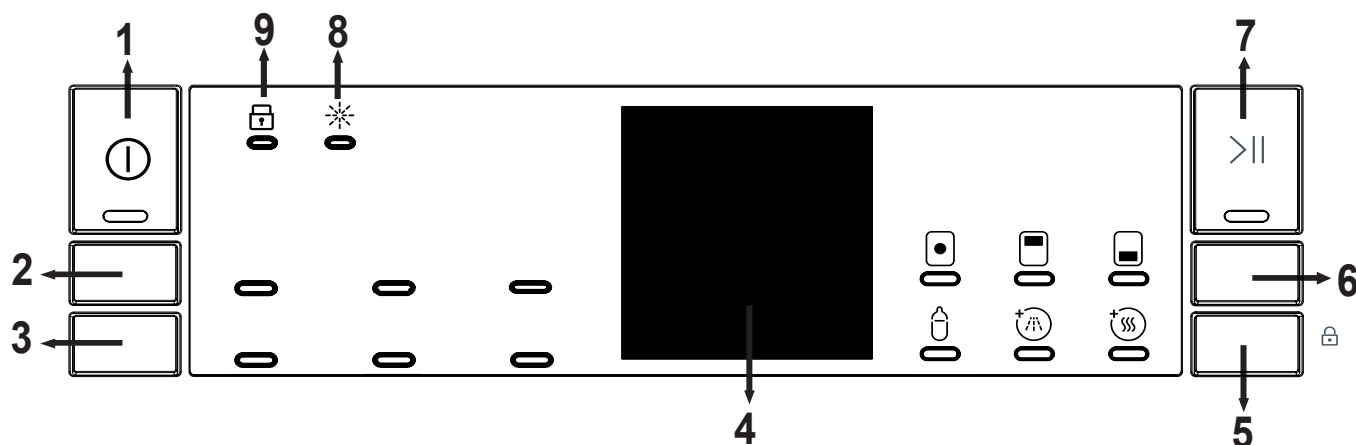

1. On/Off Button

Switch the machine on by pressing the On/Off button. The On/Off lamp lights as long as the machine is on.

2. Program Selection Button

Select a suitable program by pressing the program button.

3. Delay Button

You can delay the start time of the program for 1-2...24 hours by pressing the delay button (3) before the program starts. If you want to change the delay time, first press the Start/Pause button and then the delay button to select a new delay time. To activate the new delay time, press the Start/Pause button. To cancel the delay, you need to switch to 0 hour by using the delay when the machine is paused.

4. Remaining Time Indicator

Program flow can be monitored via the Wash, Rinse, Dry, End lamps and Remaining Time Indicator. The machine remains silent for about 40-50 minutes with respect to the flow of the program you have selected.

5. Select Button

Options can be selected by pressing the Options button repeatedly. The chosen option will be indicated by a blinking LED. Select the option by pressing the Select button. The LED for the chosen option will then remain lit.

6. Options Button

If you have used an extra feature on the latest washing program this feature will remain active on the next washing program. If you want to cancel this feature on the newly selected washing program press the options button to browse the options and press the select button to deactivate the related option or turn the machine off with the on/off button. If you would like to use an extra feature with a newly selected program select the desired function.

7. Start/Pause Button

Press the Start/Pause button to start the program. The wash lamp turns on and the Remaining Time Indicator shows the program duration. It also indicates the remaining time during the program flow. If you open the door of your machine when the program is running the duration of the program pauses, and the Start/Pause led blinks.

8. Rinse Aid Indicator

When the rinse aid level is low, the rinse aid lack warning indicator turns on and you should fill the rinse aid chamber.

9. Child lock

Child lock is activated/deactivated by pressing select button for about 3 seconds. When it is activated, all leds blink and "CL" is shown on Remaining Time Indicator (4) once. When it is deactivated, all lamps and "CL" blink twice.

CONTROL PANEL



NOTE: By selecting the half load option, three sorts of washing can be executed: both baskets, upper basket and lower basket. These options are ideal for smaller loads, allowing the dishwasher to perform smaller washes with reduced consumption.



NOTE: Select the Tablet option when using combined detergent that contains rinse aid and extra functions.



NOTE: You may select Hygiene in order to obtain a more hygienic and a cleaner washing process by altering the water temperature and washing time of the program you have selected.



NOTE: If the Rinse option is selected, washing-rinsing steps will be added into the selected program so you can ensure that your dishes will be extra clean and shiny.



NOTE: If the Drying lamp is on, extra heating and drying steps will be added into the selected program so your dishes will be dried more thoroughly.

CONTROL PANEL

NOTE: Child lock is activated/deactivated by pressing the select button (5) for about 3 seconds. When it is activated, all leds blink and "CL" is shown on the Re

NOTE: If you switch the machine to off position after selecting the delay time and the program has started, the delayed time is cancelled.

Changing a program

If you would like to change the program when the machine is already running.

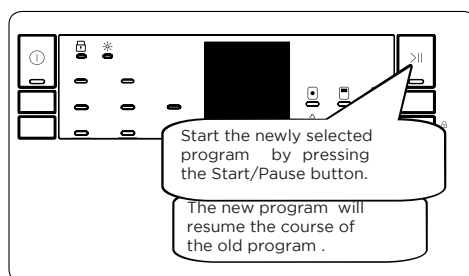
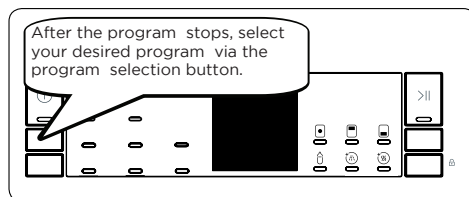
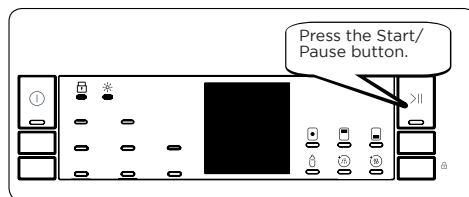

Cancelling a program

If you would like to cancel a program when it is running.

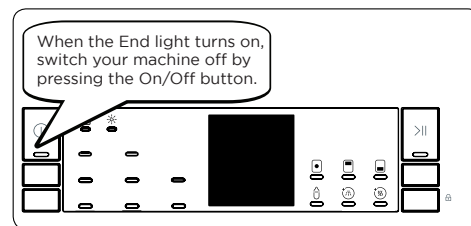
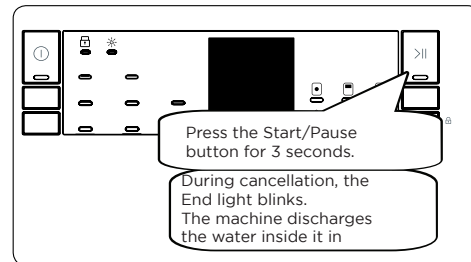

Switching the Machine Off

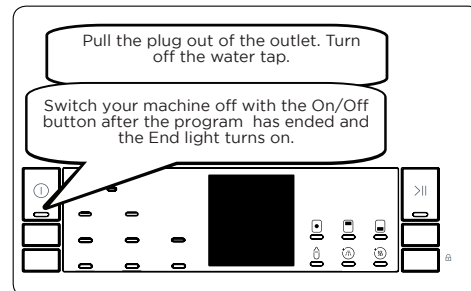

NOTE: Do not open the door before the program ends.

NOTE: At the end of washing program you can leave the door of your machine ajar to hasten the drying.

NOTE: If the door of machine is opened or power is cut off during washing, the program will continue when the door is closed or the power is restored.

PROGRAM TABLE

Program	Duration (min)	Description
Prewash	15	To rinse heavily soiled dishes before a wash program.
Fast 30'	30	Quick wash program for lightly soiled dishes.
Delicate	74	For lightly soiled delicate dishes.
Eco 50°C	155	Standard program for normally soiled daily using dishes with reduced energy and water consumptions.
TimeSave 50'	50	A faster program for dishes which are used daily but are not heavily soiled.
Heavy	122	For heavily soiled dishes.



NOTE: PROGRAM DURATION MAY CHANGE ACCORDING TO THE AMOUNT OF DISHES, TAP WATER, AMBIENT TEMPERATURE AND SELECTED ADDITIONAL FUNCTIONS.

- Only use powder detergent in short programs.
- Short programs do not include a drying step.
- To assist drying, we recommend partially opening the door after the program has finished.
- Eco 50°C program is the Energy Labelling Program and recommended for normally soiled load at the rated capacity.

Information for Test institutes

For all the necessary information for test performance; send an email to dishwasher@standardtest.info and provide the model and PNC number on the rating plate.

HINTS AND TIPS

If one of program monitor lights is on and start/pause light is flashing

- Your machine's door is open, shut the door to continue.

If the program won't start

- Check if the plug is connected.
- Check your indoor fuses.
- Check that the water inlet tap is turned on.
- Check that you have closed the machine door.
- Check that you switched off the machine by pressing the power on/off button.
- Check that the water inlet filter and the machine filters are not clogged.

If the control light is off after a wash operation

- The power on/off button isn't released yet.

If detergent residues are left in the detergent compartment

- Detergent has been added when the detergent compartment was wet.
- Large dishes have blocked the dispenser door.

If water is left inside the machine at the end of the program

- The water drain hose is clogged or twisted.
- The filters are clogged.
- The program is not finished yet.



IMPORTANT

At the end of the program, water may still remain on the sides and door of the appliance.

If the machine stops during a wash operation

- Power failure.
- Water inlet failure.
- Program is on standby mode.

If shaking and hitting noises are heard during a wash operation

- Dishes are placed incorrectly.
- The spray arm is hitting the dishes.

If there are partial food wastes left on the dishes

- Dishes are placed incorrectly into the machine, sprayed water did not reach related places.
- Basket overloaded.
- Dishes leaning against one another.
- Very small amount of detergent added.
- An unsuitable, rather weak wash program selected.
- Spray arm clogged with food waste.
- Filters clogged.
- Filters incorrectly fitted.
- Water drain pump clogged.

If there are white stains on the dishes

- A very small amount of detergent is being used.
- Rinse aid dosage setting at a very low level.
- Water hardness is very high.

If the dishes won't dry

- A program without a dry operation selected.
- Rinse aid dosage set too low.
- Dishes unloaded too fast.
- Use a hotter program.

If there is rust on the dishes

- Stainless-steel quality of the dishes washed is insufficient.
- High level of salt in the wash water.
- Unhealthy mains grounding.

Unloading the baskets

- For improved drying results with the most effective use of energy, open the door approximately 10cm at the end of the program.
- Allow the tableware to cool for 30-40 minutes as hot items can easily be damaged.
- First remove items from the lower basket before removing the items from the upper basket.

Call an authorised service if the problem still persists after the controls or in case of any malfunction not described above.

Useful Information

- Whenever you will not be operating your machine:
 - Unplug the machine and then turn water off.
 - Leave the door slightly ajar in order to prevent the formation of unpleasant smells.
- Keep the machine interior clean.
- Correct loading of dishes in the machine, enables reduced energy consumption and improved washing and drying performance.
- Remove all large food remnants before you placing dirty dishes into the machine.
- Operate the machine after it is completely full.
- If the appliance is located in a place where the risk of freezing exists, you must completely drain the water that has remained in the machine. Turn off the water tap, disconnected the water inlet hose from the tap and allow the interior water to drain.

INSTALLATION

Positioning the machine

When considering the location for the dishwasher, ensure that there is adequate space to enable loading and unloading of the dishes.

- Do not put your machine in any location where the ambient temperature can fall below 0°C.
- Before positioning, take the machine out of its packaging by following the warnings located on the package.
- Position the machine close to a water tap and drain. You need to position your machine, taking into consideration that its connections will not be altered once they are made.
- Do not grip the machine by its door or panel in order to move it.
- Take care to leave a certain clearance from all sides of the machine so that you can comfortably move it back and forth during cleaning.
- Make sure that the water inlet and outlet hoses do not get squeezed while positioning the machine. Also, make sure that the machine does not stand on the electrical cable. Adjust the machine's feet so that it is level and stable. Proper positioning of the machine ensures problem-free opening and closing of its door.
- If the door of your machine does not close properly, check if the machine is stable on the floor; if not, adjust the feet and ensure it is level and stable.

Water connection

Ensure that the indoor plumbing is suitable for installing a dishwasher and complies with AS/NZS 3500.1. Also, we recommend that you fit a filter at the entrance of your place or apartment so as to avoid any damage to your machine because of any contamination

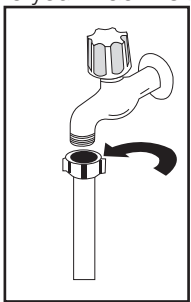

(sand, clay, rust etc) that might be occasionally carried in through the main's water supply or the indoor plumbing, and to avoid problems of staining and formation of deposits after washing.

Water inlet hose

Do not use the water inlet hose of your old machine, you must use the new water inlet hose supplied with your machine. Before connecting the water inlet hose to the water tap, ensure clean water is flowing from the tap before making the connection. Connect the water inlet hose directly to the water inlet tap. The pressure supplied by the tap should be at a minimum of 0.03 MPa and at a maximum of 1 MPa. If the water pressure is above 1 MPa, a pressure-relief valve should be installed.

WARNING

Only turn the locking nut to secure hose – do not turn the hose.

- The first time you use the appliance, make sure that there is no leakage.
- The water inlet hose has a safety valve and a sheath with an inner mains cable.
- After the connections are made, the tap should be turned on fully and checked for water tightness. For the safety of your machine, make sure to always turn off the water inlet tap after each wash program is finished.

WARNING

NOTE: A water tempering valve is required if the water temperature is over 60°C.

CAUTION

Always use new hoses when you connect the appliance to the water supply. Old hoses must not be used. The water inlet hose must be examined at an interval of twelve months for deterioration and replaced if necessary.

In order to pass the safety valve through the kitchen cabinets, an opening of at least 45mm x 90mm is needed.

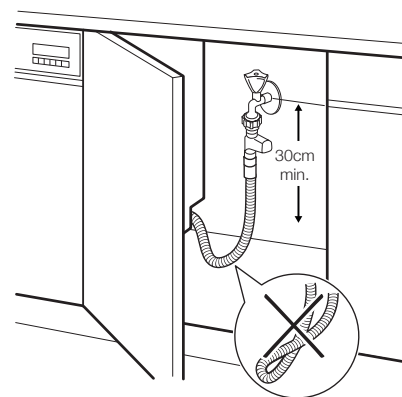

INSTALLATION

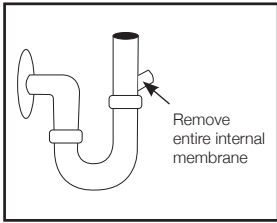

Water drain hose

If you connect the water drain hose to a trap spigot under the sink, remove the plastic membrane. If you do not remove the entire membrane, remaining food can cause blockage in

the drain hose spigot. Ensure a hose clamp is used to secure the hose to the spigot.

Water drain hose

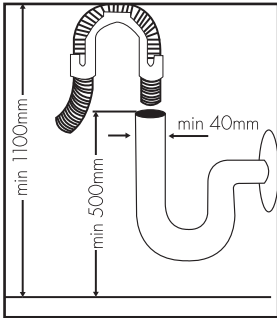

The water drain hose can be connected either directly to the water drain hole or to the sink outlet spigot. Using a hose hook (if available), the water can be drained directly into the sink by positioning the hose hook over the edge of the sink.

This connection should be at a minimum of 50cm and at a maximum of 110cm above the base of the dishwasher.



WARNING

Maximum drain hose length is 4m. Longer hose length will prevent correct draining, and result in poor wash performance.

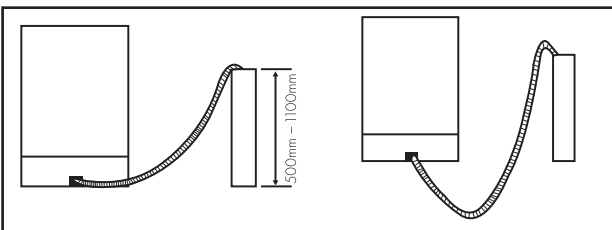

☑
(correct)

☒
(incorrect)



WARNING

Electrical Connection

The plug of your machine should be connected to an earthed outlet that supplies suitable voltage and current. If there is no earthing installation, have a competent electrician carry out an earthing installation. In case of usage without earthing installed, our company will not be responsible for any loss of usage that might occur.

The indoor fuse current value should be 10-16 A.

Your machine is designed for 220-240 V. The machine should not be plugged in during installation.

- Always use the molded plug supplied with your machine.
- Running in low voltage will cause a decline in washing quality.
- The machine's electrical cable should be replaced by an authorised service or an authorised electrician only. Failure to do so may lead to accidents.
- For safety purposes, always make sure to disconnect the plug when a wash program is finished.
- In order not to cause an electric shock, do not unplug when your hands are wet.
- When disconnecting your machine from the mains supply, always pull from the plug. Never pull the cord itself.

Fitting the machine undercounter

If you wish to fit your machine undercounter, check whether you have sufficient space under your countertop and whether the wiring-plumbing is suitable to do so.

1. To ensure the stability of the dishwasher for an underbench installation, if the underbench dimension is greater than 820mm, any gap between the dishwasher and the underside of the benchtop should be bridged with a packing piece. This may be achieved by wedging a piece of timber between the dishwasher and the benchtop as shown
2. If required, remove the worktop as shown in the illustration.
3. To remove the worktop, remove the screws that hold the worktop which are located at the rear of the machine; then push the front panel 1cm from the front

INSTALLATION

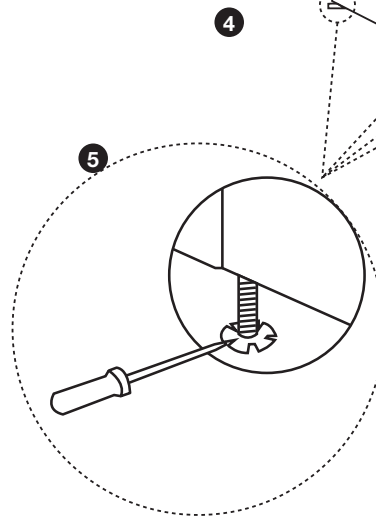
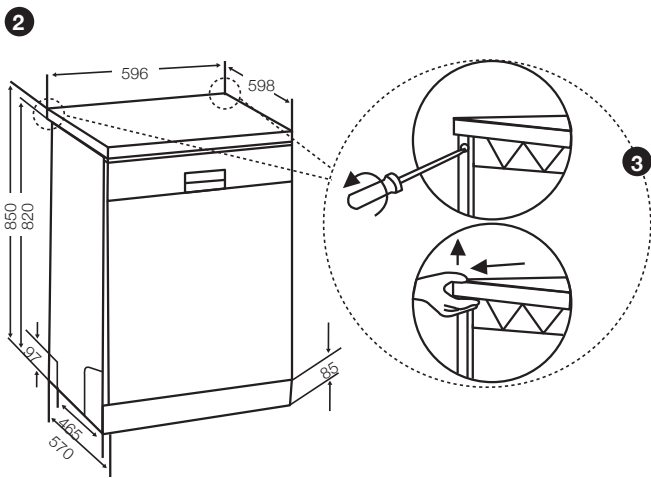
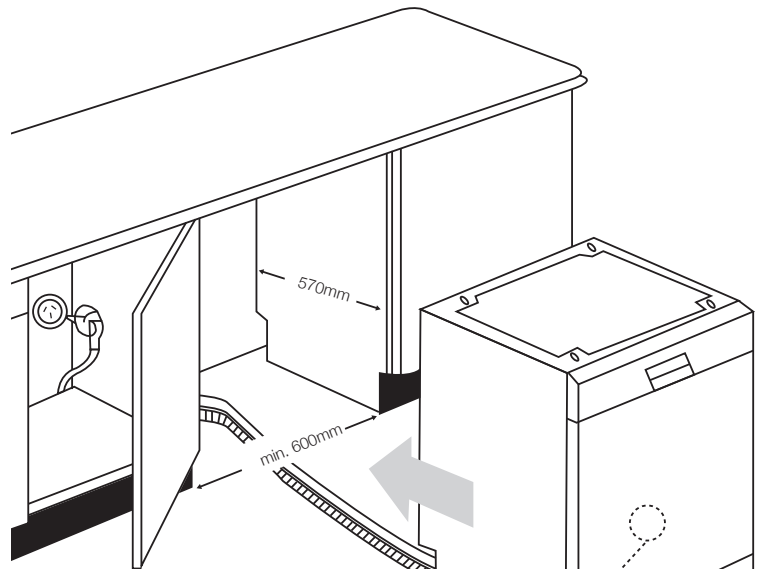
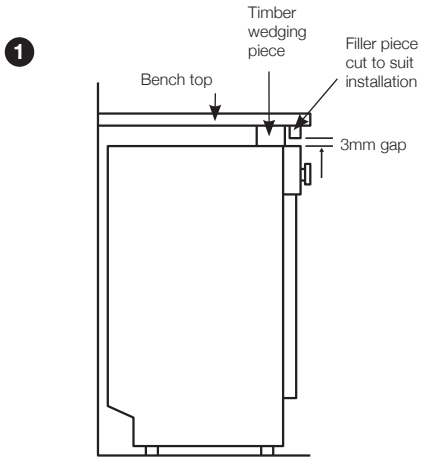

1. towards the rear and lift it.
2. Adjust the machine feet according to the slope of the floor.
3. Fit your machine by pushing it undercounter without letting the hoses get crushed or bent.

WARNING

After removal of worktop, ensure the opening for the dishwasher is according to the following dimensions.

PREPARING FOR USE

Detergent usage

Use a detergent specifically designed for use in domestic dishwashers. You can find powder, gel and tablet detergents in the market that have been designed for household dishwashers. Detergent should be put into the compartment prior to starting the machine. Keep your detergents in cool, dry places out of reach of children. Do not fill detergent into the detergent compartment more than required; otherwise it may cause scratches on your glasses as well as lead to a poorly dissolved detergent. Should you need more information concerning the detergent you will use, contact detergent manufacturers directly.

Filling the detergent compartment

Push the latch to open the detergent container as shown in the image.

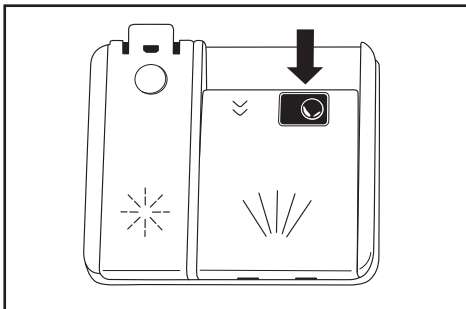

The Detergent pod has level lines inside. It is possible to measure the right detergent amount using these lines.

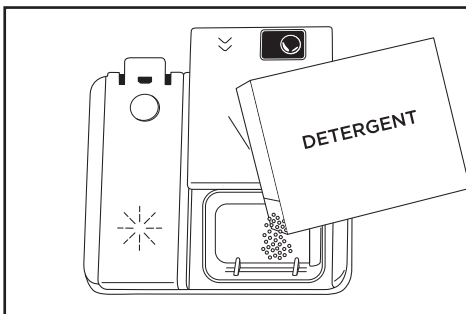

The detergent pod can take a maximum of 40cm³ detergent.

Open the dishwasher detergent pod and pour 25cm³ if your dishes are heavily soiled or 15cm³ if they are less soiled.

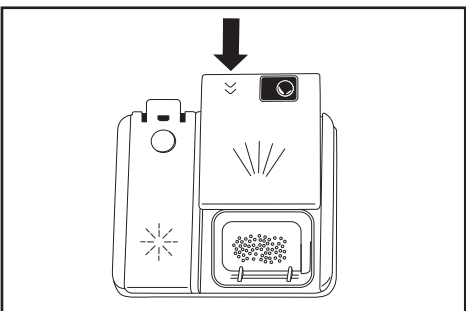

To close the detergent container, push the cover as shown until it locks.

PREPARING FOR USE

You may have to add more detergent into your machine, depending on the degree of soil and the water hardness in your area.

If your dishes are from the previous day and there is dried food waste on them, or if you have fully loaded the dishwasher, pour 5cm³ detergent onto the base of the door and start your machine.

Combined detergent

Detergent manufacturers also produce combined detergents called "2 in 1", "3 in 1" or "5 in 1" etc. "2 in 1" detergents contain detergent + rinse aid. When using "2 in 1" detergents make sure to check the specifications of the tablet.

Other tablet detergents contain detergent + rinse aid + various extra functions.

Generally, combined detergents produce suitable results under certain usage conditions only.

These detergents contain rinse aid and/or other additives in preset amounts.

Points to consider when using these type of products:

- Always make sure to check the specifications of the product you will use or whether or not it is a combined product.
- Check if the detergent used is appropriate for the hardness of mains water that machine relates to.
- Observe the instructions on packaging when using such products.
- If such detergents are in the form of tablets, never put them into the interior section or the cutlery basket of the dishwasher. Always put the tablets into the detergent compartment in the detergent dispenser.
- They produce good results for certain types of usage only. If you are using this type of detergent, you need to contact the manufacturers and find out about the suitable conditions of use.
- When the conditions of use of such products and the machine settings are appropriate, they ensure savings in salt and/or rinse aid consumption.
- Contact the detergent manufacturer if you are not obtaining good wash results (if your dishes stay calcareous and wet) after having used 2 in 1 or 3 in 1 detergents. The scope of warranty for your machine does not cover any complaints caused by the use of these types of detergents.

Recommended usage:

For better results while using combined detergents, add rinse aid into your machine and adjust the rinse aid setting to the lowest position.

PREPARING FOR USE

CAUTION

Solubility of the tablet detergents produced by different companies can vary depending on the temperature and time. Therefore, it is not recommended to use such detergents in short programs. It is more suitable to use powder detergents in such programs.

Should any problem, which you have not encountered before, arise with the use of this type of detergents, contact the detergent manufacturers directly.

When you give up using combined detergents

- Fill the rinse aid compartment.
- Set the suitable rinse aid setting.

Filling with rinse aid and making the setting

To fill the rinse aid compartment, open the rinse-aid compartment cap.

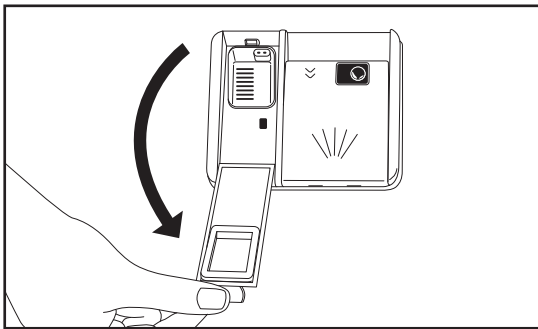
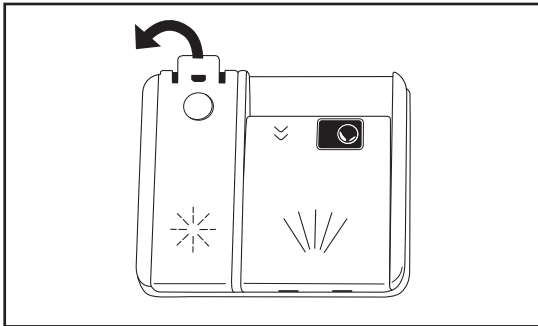

Fill the compartment with rinse aid until MAX level and then close the cap.

Be careful not to overfill the rinse aid compartment and wipe up any spills.

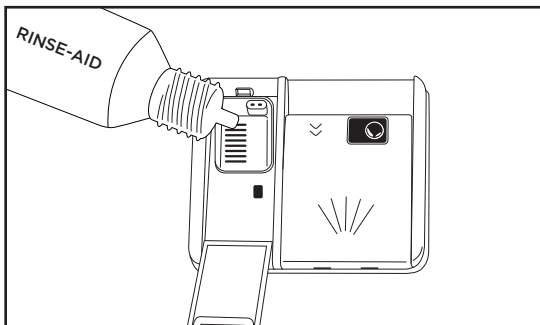

In order to set rinse aid level, follow below steps:

- Turn on the machine by pressing On/ Off button.
- Press Program button at least for 5" immediately after machine is turned on.
- Release Program button when "rA" is shown. Rinse aid level setting follows water hardness level setting. Next, the last setting level is viewed.
- Set the level by pushing the program button.
- Switch off the machine to save the setting.
- The factory setting is "4".

If the dishes are not drying properly or are spotted, increase the level. If blue stains form on your dishes, decrease level.

Level	Brightener Dose	Indicator
1	Rinse-aid not dispensed	r1 is shown on the display.
2	1 dose is dispensed	r2 is shown on the display.
3	2 doses are dispensed	r3 is shown on the display.
4	3 doses are dispensed	r4 is shown on the display.
5	4 doses are dispensed	r5 is shown on the display.

CAUTION

Use only those rinse aid materials which are allowed for use in the machine. As rinse aid residues left as a result of overflowing will create extremely high amounts of foam and thus reduce the washing performance, remove the excess amount of rinse aid by wiping it with a paper towel or cloth.

LOADING YOUR DISHWASHER

If your dishes are correctly placed in the dishwasher, you will be using it in the best way in terms of energy consumption, washing and drying performance.

There are two separate baskets for you to load your dishes into your machine. You can load into the lower basket such round and deep items as pots with long handles, pot lids, plates, salad plates, cutlery sets.

The upper basket has been designed for tea plates, dessert plates, salad bowls, cups and glasses. When placing long-stem glasses and goblets, lean them against the basket edge, rack or glass supporter wire and not against other items. Do not lean long glasses against one another or they won't remain steady and can be damaged.

It is recommended that thin narrow items be placed into the middle sections of baskets. You can place spoons among the other cutlery sets in order to prevent them from sticking to one another, use the cutlery grid in order to obtain the best result.

To avoid any possible injuries, always place long-handle and sharp-pointed dishes such as serving fork or bread knife with their sharp points facing down or horizontally on the baskets.



CAUTION

Place your dishes into your machine in a way that they will not prevent the upper and lower spray arms from spinning.

Top basket cup rack

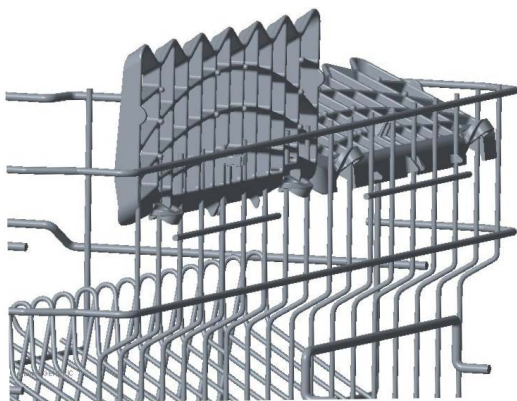

Height Adjustable Rack

These racks are designed to increase the capacity of the top basket. You can place your glasses and cups on the racks. You can adjust the height of these racks. Thanks to this feature, you can place different sizes of glasses under these racks.

Thanks to height adjustment plastics mounted on the basket, you can use your racks in two different heights. In addition, you can place long forks, knives and spoons on these racks laterally, so that they do not block the revolution of propeller.

Upper basket height adjustment while it is full

Basket height adjustment mechanism on the upper basket of your machine is designed to let you adjust the height of your upper basket (refer to diagram 1) upwards or (refer to diagram 2) downwards, without removing it from your machine when it is full, to create large spaces at the upper or bottom area of your machine as needed.

The basket of your machine is set to the upper position from the factory.

In order to raise your basket, hold it from both sides and pull it upwards. In order to lower it, hold it from both sides again, pull upwards and then lower carefully.

Make sure that both sides are in the same position (up or down).

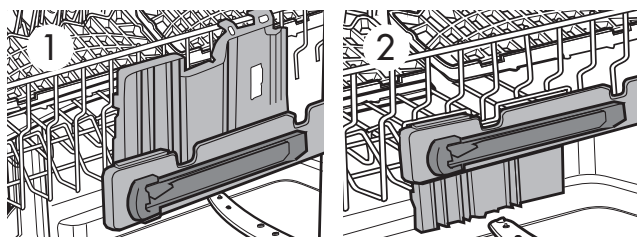
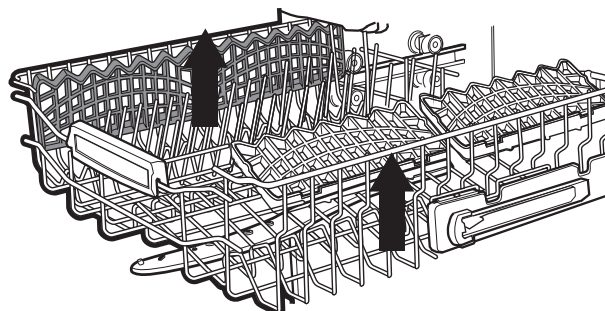

LOADING YOUR DISHWASHER

Alternative basket loads

Lower Basket

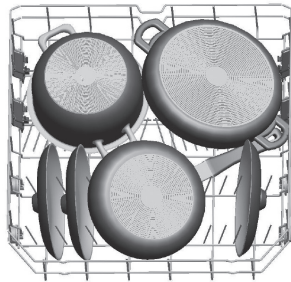
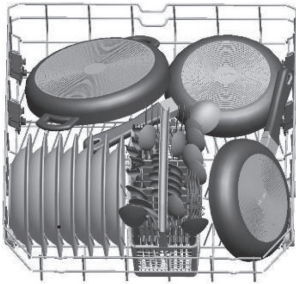

Top Basket

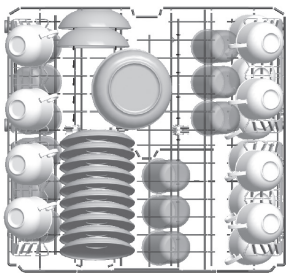

LOADING YOUR DISHWASHER

Four Folding Racks

The folding racks are designed so that large items, such as pots and pans, can be easily placed in the dishwasher. Each section can be folded separately. The racks can be folded down or raised up, as shown in the images below.

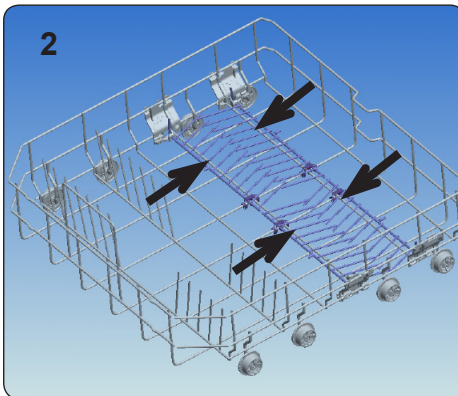
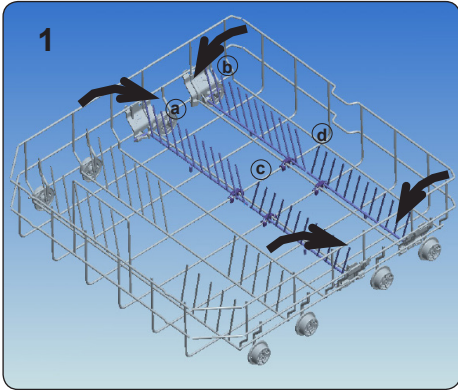

LOADING YOUR DISHWASHER

Alternative basket loads Lower Basket

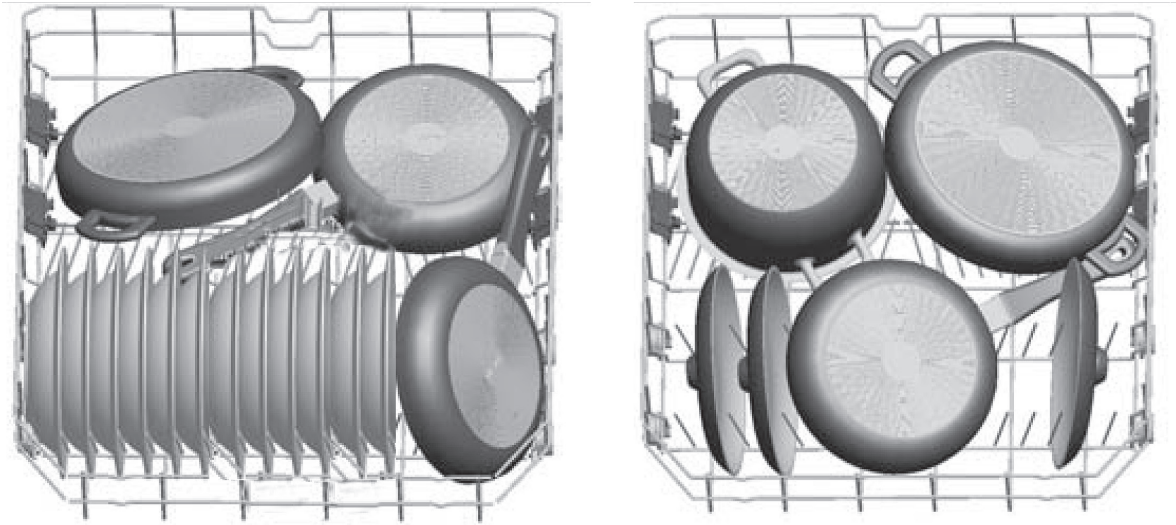

* Illustration only

Top Basket

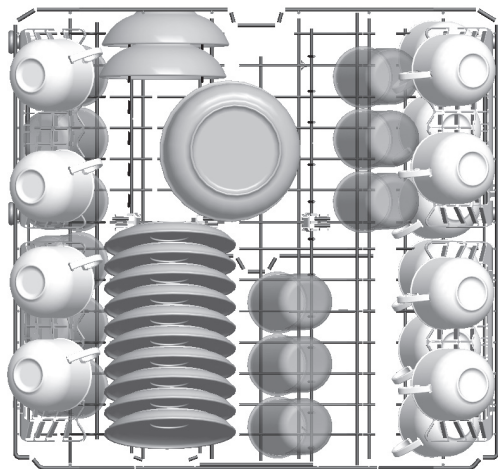

i **IMPORTANT**
Examples of incorrect loading

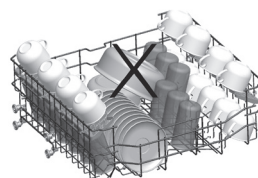
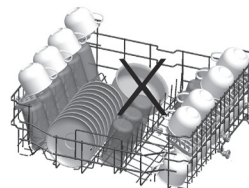
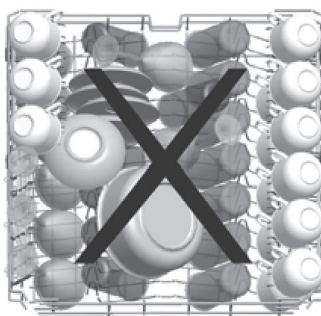

MAINTENANCE AND CLEANING



IMPORTANT

Cleaning the machine in regular intervals prolongs the machine's service life.

Oil and lime may accumulate in the machine's washing section. In case of such accumulation;

- Fill the detergent compartment without loading any dishes into the machine, select a program that runs at high temperature, and start the machine. If this is ineffective, use a specialty dishwasher cleaner available from most supermarkets.

Cleaning the seals in the machine door

- To clean any accumulated residues in the door seals, wipe the seals regularly by using a dampened cloth.

Cleaning the machine

- Clean the filters and spray arms at least once a week.
- Unplug your machine and turn off its tap before starting the cleaning.
- Do not use hard materials when cleaning your machine. Wipe with a fine cleaning material and a dampened cloth.

Filters

- Check if any food wastes have remained on the coarse and fine filters.
- If any food wastes are left, remove the filters and clean them thoroughly under the water tap.

- a** Micro Filter
- b** Coarse Filter
- c** Metal/Plastic Filter

To remove and clean the filter combination, turn it counter clockwise and take it out by lifting upwards. **1**

Pull and remove the metal/plastic filter. **3**

Then pull the coarse filter out of the micro filter. **2**
Rinse it with lots of water under the tap. Refit the metal/plastic filter. Insert the coarse filter into the micro filter in away that the marks will correspond to one another. Attach micro filter into the metal/plastic filter and turn to the direction of arrow and it is locked when the arrow on micro filter can be seen from across. **4**

- Never use your dishwasher without any filter.
- Incorrect fitting of the filter will reduce the washing effectiveness.
- Clean filters are very important in terms of the proper running of the machine.

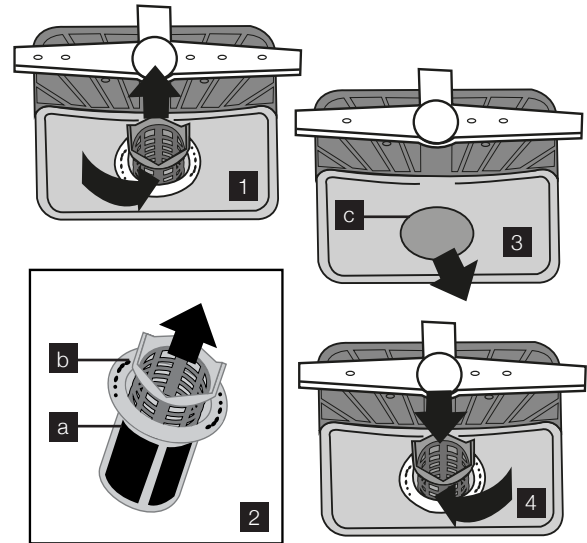

Spray arms

Check whether or not the holes for the upper and lower spray arms are clogged. If there is any clogging, remove the spray arms and clean them under water.

You can remove the lower spray arm by pulling it upwards, while the upper spray arm nut can be removed by turning the nut to the left.

Be sure that the nut is perfectly tightened when refitting the upper spray arm.

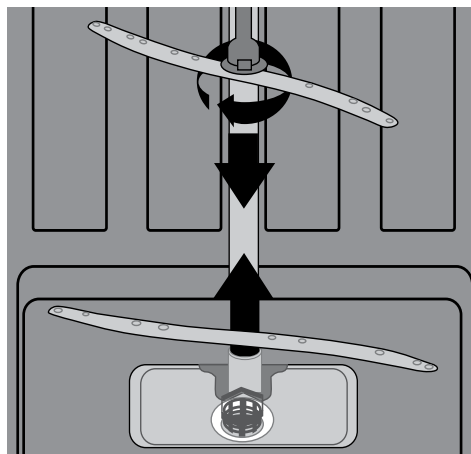

Hose filter

Water is stopped by the inlet hose filter to avoid any damage to your machine because of any contamination (sand, clay, rust etc.) that might be occasionally carried in through the mains water supply or the indoor plumbing, and to forestall such issues as yellowing and formation of deposits after washing. Check the filter and the hose from time to time and clean them if necessary. To clean the filter, first turn off your tap and then remove the hose. After removing the filter from the hose, clean it under the tap. Insert the cleaned filter back into its place inside the hose. Refit the hose.

TROUBLESHOOTING

Error code	Possible cause and solution	Control
F1	Overfill	<ul style="list-style-type: none"> • Power off your machine and close the tap. • Contact the customers services centre.
F2	Not draining	<ul style="list-style-type: none"> • Water discharge hose is clogged. • Water drainage hose kinked, check installation. • The filters of your machine might be clogged. • Power off–on your machine and activate the program cancellation command. • If the error continues, contact the Customer Care Centre.
F3	Inlet valve faulty	<ul style="list-style-type: none"> • Close the tap. • Contact the Customer Care Centre.
F5	Inadequate water supply	<ul style="list-style-type: none"> • Make sure the water tap is fully open and that there is mains water available. • Water inlet hose kinked, check installation. • Close the water tap, disconnect the hose from the tap and clean the filter at the connection. • Restart your machine, contact the service if the error resumes.
F6	Faulty heater sensor	<ul style="list-style-type: none"> • Contact the Customer Care Centre.
F7	Over temperature	<ul style="list-style-type: none"> • Contact the Customer Care Centre.
F8	Heating error	<ul style="list-style-type: none"> • Contact the Customer Care Centre.
F9	Diverter valve faulty	<ul style="list-style-type: none"> • Contact the Customer Care Centre.
FE	Power supply problem	<ul style="list-style-type: none"> • Contact the Customer Care Centre.



FOR SALES IN AUSTRALIA AND NEW ZEALAND
APPLIANCE: WESTINGHOUSE DISHWASHERS

This document sets out the terms and conditions of the product warranties for Westinghouse Appliances. It is an important document. Please keep it with your proof of purchase documents in a safe place for future reference should there be a manufacturing defect in your Appliance. This warranty is in addition to other rights you may have under the Australian Consumer Law.

1. In this warranty:

- (a) 'ACL' or 'Australian Consumer Law' means Schedule 2 to the Competition and Consumer Act 2010;
- (b) 'Appliance' means any Electrolux product purchased by you and accompanied by this document;
- (c) 'ASC' means Electrolux's authorised serviced centres;
- (d) 'Westinghouse' is the brand controlled by Electrolux Home Products Pty Ltd of 163 O'Riordan Street, Mascot NSW 2020, ABN 51 004 762 341 in respect of Appliances purchased in Australia and Electrolux (NZ) Limited (collectively "Electrolux") of 3-5 Niall Burgess Road, Mount Wellington, in respect of Appliances purchased in New Zealand;
- (e) 'Warranty Period' means the period specified in clause 3 of this warranty;
- (f) 'you' means the purchaser of the Appliance not having purchased the Appliance for re-sale, and 'your' has a corresponding meaning.

2. Application: This warranty only applies to new Appliances, purchased and used in Australia or New Zealand and is in addition to (and does not exclude, restrict, or modify in any way) other rights and remedies under a law to which the Appliances or services relate, including any non-excludable statutory guarantees in Australia and New Zealand.

3. Warranty Period: Subject to these terms and conditions, this warranty continues for in Australia for a period of 24 months and in New Zealand for a period of 24 months, following the date of original purchase of the Appliance.

4. Repair or replace warranty: During the Warranty Period, Electrolux or its ASC will, at no extra charge if your Appliance is readily accessible for service, without special equipment and subject to these terms and conditions, repair or replace any parts which it considers to be defective. Electrolux may, in its absolute discretion, choose whether the remedy offered for a valid warranty claim is repair or replacement. Electrolux or its ASC may use refurbished parts to repair your Appliance. You agree that any replaced Appliances or parts become the property of Electrolux.

5. Travel and transportation costs: Subject to clause 7, Electrolux will bear the reasonable cost of transportation, travel and delivery of the Appliance to and from Electrolux or its ASC. Travel and transportation will be arranged by Electrolux as part of any valid warranty claim.

6. Proof of purchase is required before you can make a claim under this warranty.

7. Exclusions: You may not make a claim under this warranty unless the defect claimed is due to faulty or defective parts or workmanship. This warranty does not cover:

- (a) light globes, batteries, filters or similar perishable parts;
- (b) parts and Appliances not supplied by Electrolux;
- (c) cosmetic damage which does not affect the operation of the Appliance;

- (d) damage to the Appliance caused by:
 - (i) negligence or accident;
 - (ii) misuse or abuse, including failure to properly maintain or service;
 - (iii) improper, negligent or faulty servicing or repair works done by anyone other than an Electrolux authorised repairer or ASC;
 - (iv) normal wear and tear;
 - (v) power surges, electrical storm damage or incorrect power supply;
 - (vi) incomplete or improper installation;
 - (vii) incorrect, improper or inappropriate operation;
 - (viii) insect or vermin infestation;
 - (ix) failure to comply with any additional instructions supplied with the Appliance;

In addition, Electrolux is not liable under this warranty if:

- (a) the Appliance has been, or Electrolux reasonably believes that the Appliance has been, used for purposes other than those for which the Appliance was intended, including where the Appliance has been used for any non-domestic purpose;
- (b) the Appliance is modified without authority from Electrolux in writing;
- (c) the Appliance's serial number or warranty seal has been removed or defaced

8. How to claim under this warranty: To enquire about claiming under this warranty, please follow these steps:

- (a) carefully check the operating instructions, user manual and the terms of this warranty;
- (b) have the model and serial number of the Appliance available;
- (c) have the proof of purchase (e.g. an invoice) available;
- (d) telephone the numbers shown below.

9. Australia: For Appliances and services provided by Electrolux in Australia: Electrolux goods come with guarantees that cannot be excluded under the Australian Consumer Law. You are entitled to a replacement or refund for a major failure and for compensation for any other reasonably foreseeable loss or damage. You are also entitled to have the Appliance repaired or replaced if the Appliance fails to be of acceptable quality and the failure does not amount to a major failure. 'Acceptable quality' and 'major failure' have the same meaning as referred to in the ACL.

10. New Zealand: For Appliances and services provided by Electrolux in New Zealand, the Appliances come with a guarantee by Electrolux pursuant to the provisions of the Consumer Guarantees Act, the Sale of Goods Act and the Fair Trading Act. Where the Appliance was purchased in New Zealand for commercial purposes the Consumer Guarantee Act does not apply.

11. Confidentiality: You accept that if you make a warranty claim, Electrolux and its agents including ASC may exchange information in relation to you to enable Electrolux to meet its obligations under this warranty.

Important Notice

Before calling for service, please ensure that the steps listed in clause 8 above have been followed.

<p>FOR SERVICE or to find the address of your nearest authorised service centre in Australia PLEASE CALL 13 13 49 For the cost of a local call (Australia only)</p>	<p>AUSTRALIA ELECTROLUX HOME PRODUCTS 163 O'Riordan Street, Mascot NSW 2020 electrolux.com.au</p>	<p>FOR SPARE PARTS or to find the address of your nearest spare parts centre in Australia PLEASE 13 13 50 For the cost of a local call (Australia only)</p>
<p>FOR SERVICE or to find the address of your nearest authorised service centre in New Zealand PLEASE CALL 0800 10 66 10 (New Zealand only)</p>	<p>NEW ZEALAND ELECTROLUX (NZ) Limited 3-5 Niall Burgess Road, Mount Wellington electrolux.co.nz</p>	<p>FOR SPARE PARTS or to find the address of your nearest spare parts centre in New Zealand PLEASE 0800 10 66 20 (New Zealand only)</p>

For more information on all Westinghouse appliances, or for dimension and installation information, call into your retailer, phone or email our customer care team or visit our website:

AUSTRALIA

service: 13 13 49
spare parts: 13 13 50
email: customercare@electrolux.com.au
web: westinghouse.com.au

NEW ZEALAND

service: 0800 10 66 10
spare parts: 0800 10 66 10
email: customercare@electrolux.co.nz
web: westinghouse.co.nz

 and WESTINGHOUSE are trademarks of Westinghouse Electric Corporation.
Used under license by Electrolux Home Products Pty Ltd. All Rights Reserved.

© 2019 Electrolux Home Products Pty Ltd. ABN 51 004 762 341
WMAN_WSF6606_Sep19

