



Automatic machine for espresso coffee and hot beverages

AULIKA EVO

Type: SUPO40 E R
Type: SUPO40 E RB

5.4 Installation of Payment Systems

This machine is designed to manage specific payment systems according to the needs of the service provider.

 The payment system must be purchased and installed by the service provider.

The payment systems are:

- "Stepper" coiner;
- "Apollo" system "Rfid" sensor.

The following sections explain the procedures for installing the two systems in the machine.

5.4.1 Installing the Coiner Box

The machine has been specially conceived and designed to interface with all "Stepper" coiners available on the market.

 The coiner must be purchased and installed by the service provider.

 Please refer to the coiner manual for each coiner programming option.

The coiner (not supplied) must be installed in the (optional) box provided upon request.

Follow the instructions below to install the box:

 Before carrying out the steps below, please make sure the machine is switched off.

Remove the drip tray.

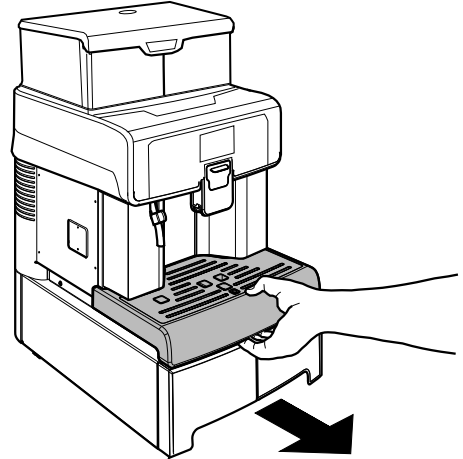

Lift the hot water wand.

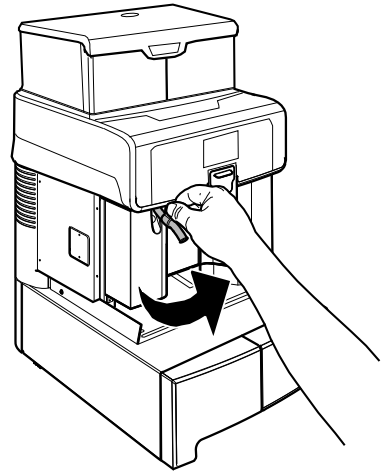

Remove the screw shown in the picture.

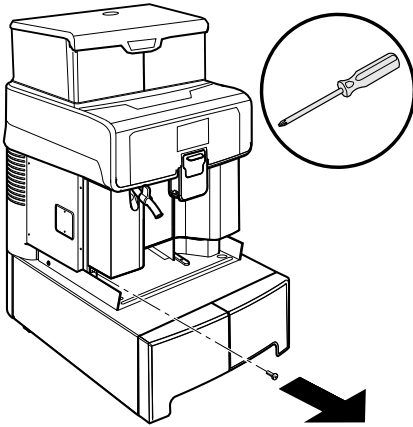

Remove the coffee dispensing spout.

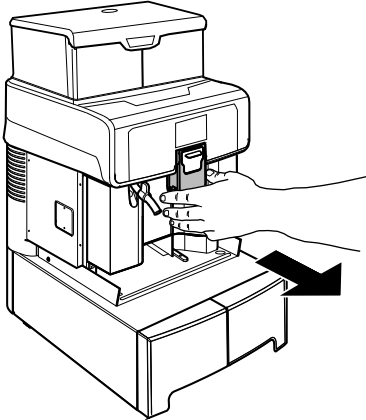

Remove the front cover by pushing on its sides to disengage the fixing elements.

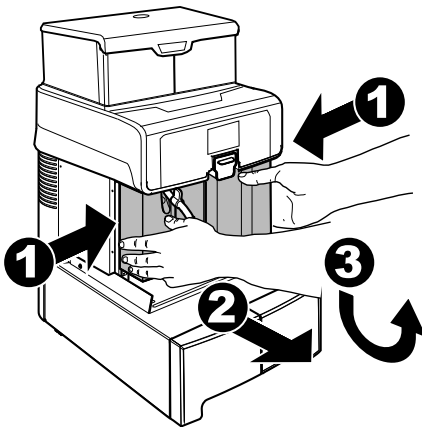

Remove the lid on the left-hand side by loosening the 2 screws.

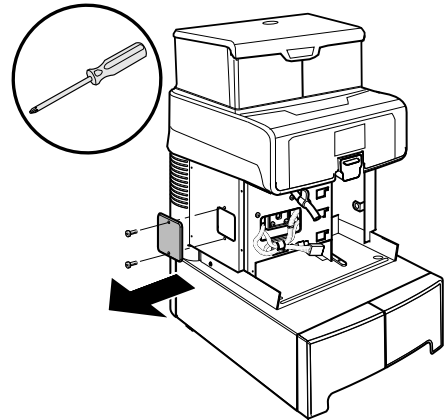

Install the spacer on the left-hand side of the machine and fix it using the 4 screws supplied.

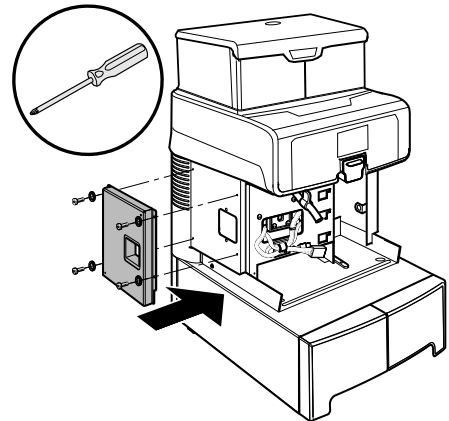

 The machine has two different connectors, a square-shaped one for the "Apollo" payment system and a rectangular one to connect the coiner.

Place the wiring harnesses as shown in the figure and pass the longer one through the hole.

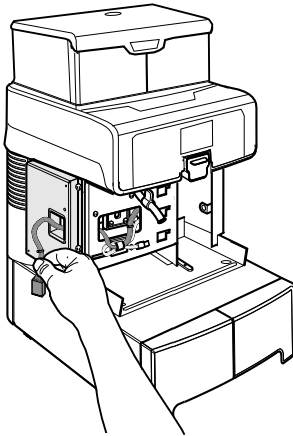

Fix the coiner box to the spacer using the 2 screws supplied.

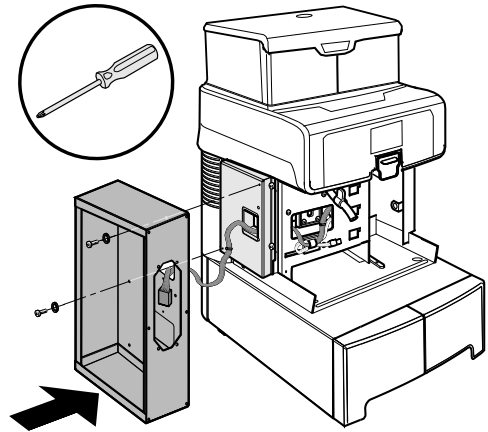

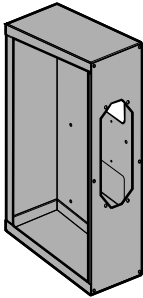

Prepare the box containing the coiner.



 The connecting cable must be properly inserted in the box.

After installing the box, install the coiner inside the box as described in the instructions given in the coiner manual. After installing the coiner in the box, close the box using the key.

 The box is just a container housing the coiner to ensure its proper installation and interface with the machine.

 The purchase and installation of the coiner are at the service provider's expenses.

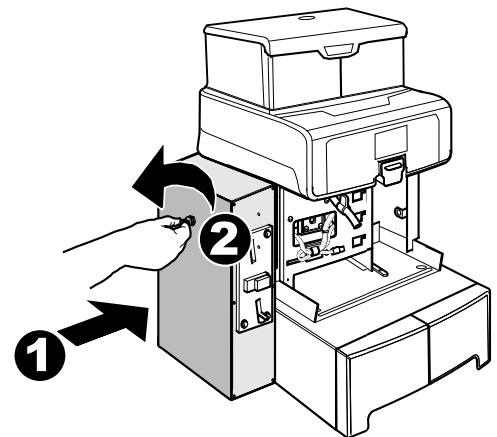

Insert the front cover and fix it by means of the screw previously removed. Insert the coffee dispensing spout. Reassemble the drip tray.

After installing the coiner, enable the products dispensed upon payment and set their price. Access the programming mode to carry out this procedure.

 The machine allows you to select a price line (0, 1, 2) whose associated value is set by the payment system through a dedicated software.

5.4.2 Installing the "Apollo" System

The machine has been specially conceived and designed to accommodate an "Apollo" payment system. This system allows you to use prepaid cards for product dispensing.

 The "Apollo" system must be purchased and installed by the service provider. Please refer to the "Apollo" system manual for each programming option.

Follow the instructions below to install the Apollo system:

 Before carrying out the steps below, please make sure the machine is switched off.

Remove the drip tray.

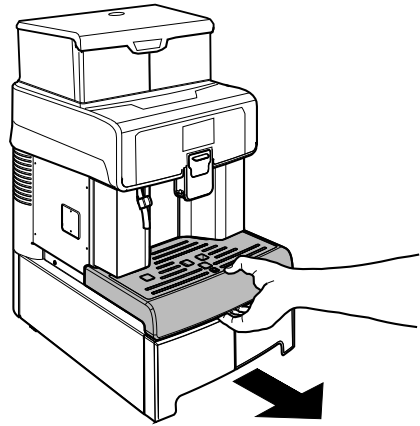

Lift the hot water wand.

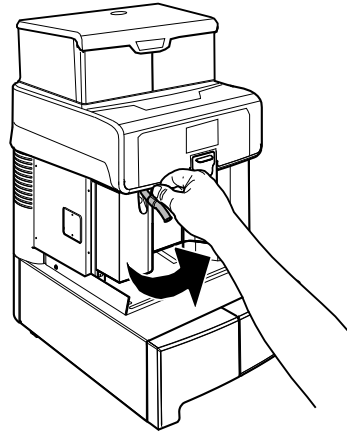

Remove the screw shown in the picture.

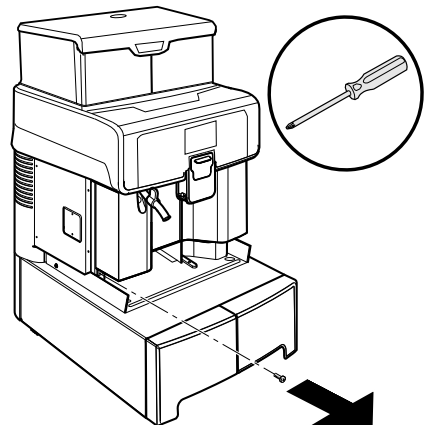

Remove the coffee dispensing spout.

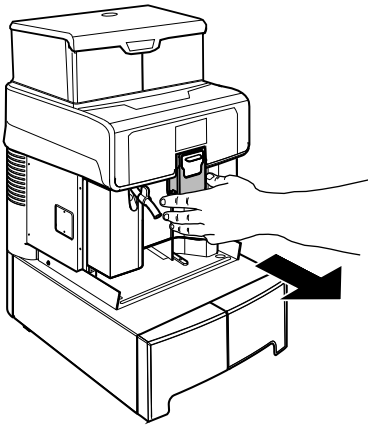

Insert the front cover and fix it by means of the screw previously removed. Insert the coffee dispensing spout. Reassemble the drip tray.

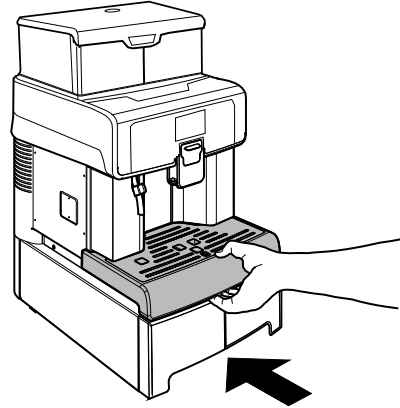

Remove the front cover by pushing on its sides to disengage the fixing elements.

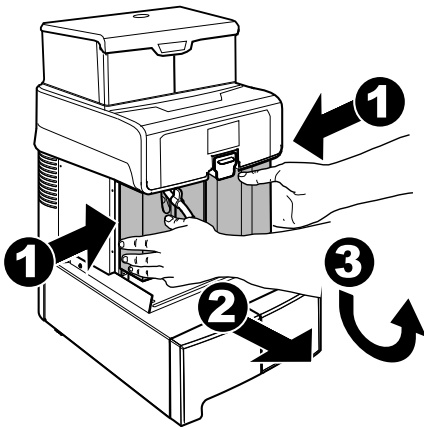

Following installation, enable the products dispensed upon payment and set their price. Access the programming mode to carry out this procedure.

 The machine allows you to select a price line (0, 1, 2) whose associated value is set by the payment system through a dedicated software.

Install the sensor on the inner side of the front cover. When the sensor has been installed, connect it.

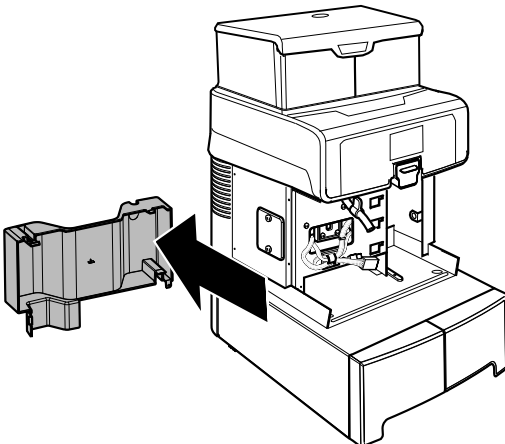

5.5 Connection to the Electric Network

 This operation must only be performed by specialised technical personnel or by the service provider.

 The device must be connected to a power supply with a maximum electric impedance (Z) of 0.388 ohm.

The Maintenance Technician, who is in charge of the appliance's installation, shall make sure that:

- the power supply system complies with the safety instructions in force;
- the voltage corresponds to that indicated on the appliance data plate.

 In case of doubt, do not proceed with the installation and ask qualified and authorised personnel to accurately check the system.

 Do not use adapters or multi-sockets.

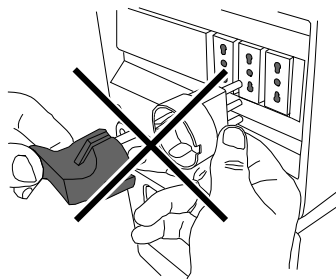

 Make sure that the power cord plug is easily reachable after installation.

6 DESCRIPTION OF CONTROLS

6.1 Power button

It is located in the rear of the machine.

If set to the "I" position the machine turns on (electrical functions enabled).

If set to the "O" position the machine turns off (electrical functions disabled).

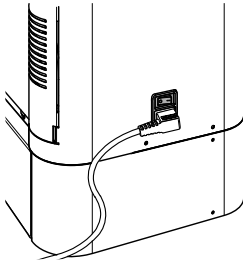

6.2 Display

The display shows the messages during normal operation and during the programming and maintenance phase.

6.3 Keypad

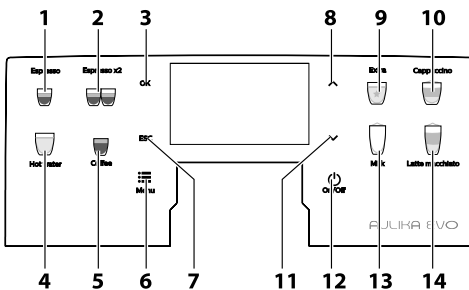

- | | |
|----|----------------------|
| 1 | "Espresso" button |
| 2 | "Espresso x2" button |
| 3 | "OK" button |
| 4 | "Hot Water" button |
| 5 | "Coffee" button |
| 6 | "Menù" button |
| 7 | "ESC" button |
| 8 | "Up" button |
| 9 | "Extra" button |
| 10 | "Cappuccino" button |
| 11 | "Down" button |

- | | |
|----|--------------------------|
| 12 | "Stand-by" button |
| 13 | "Milk" button |
| 14 | "Latte Macchiato" button |

6.4 Button Description during Normal Operation

"Espresso" button

When this button is pressed, an espresso coffee is brewed.

In the brewing phase, when the corresponding LED light is steady on, the button can be pressed again to stop the beverage.

"Espresso x2" button

When this button is pressed, two espresso coffees are brewed.

In the brewing phase, when the corresponding LED light is steady on, the button can be pressed again to stop the beverage.

"OK" button

This button allows you to confirm the selected menu option.

In the PROGRAMMING phase, the OK button can only be pressed when the message "OK TO SAVE" appears on the screen.

"Hot Water" button

When this button is pressed, hot water is dispensed.

In the brewing phase, when the corresponding LED light is steady on, the button can be pressed again to stop the beverage.

"Coffee" button

When this button is pressed, a cup of coffee is brewed.

In the brewing phase, when the corresponding LED light is steady on, the button can be pressed again to stop the beverage.

"Menù" button

Press this button to access the user menu, which allows you to wash certain components of the machine (Cappuccinatore and brew group), and to access the technical menu, if necessary, to perform maintenance and other operations.

"ESC" button

In the BREWING phase, pressing the ESC button will stop the dispensing cycle or cancel the beverage request, if pressed during the grinding phase.

In the PROGRAMMING phase, this button allows you to exit without changing the edited or selected parameter.

"Up" button

Press this button to scroll up the user menu options.

It can also be used to increase the configurable numerical parameters in the menu (for example, brightness).

"Extra" button

When this button is pressed, the menu for preparing other types of beverages is accessed.

In the brewing phase, when the corresponding LED light is steady on, the button can be pressed again to stop the beverage.

"Cappuccino" button

When this button is pressed, a cappuccino is brewed.

In the brewing phase, when the corresponding LED light is steady on, the button can be pressed again to stop the beverage.

"Down" button

Press this button to scroll down the user menu options.

It can also be used to decrease the configurable numerical parameters in the menu (for example, brightness).

"Stand-by" button

By pressing the Stand-by button, a screen will appear asking the user to press the button for 3 seconds to enter Stand-by mode.

If the user releases the button before 3 seconds have elapsed, the message "PLEASE WAIT" will appear and, after 2 seconds, it will return to READY FOR USE mode.

"Milk" button

When this button is pressed, a cup of milk is dispensed.

In the brewing phase, when the corresponding LED light is steady on, the button can be pressed again to stop the beverage.

"Latte Macchiato" button

When this button is pressed, a Latte Macchiato is brewed.

In the brewing phase, when the corresponding LED light is steady on, the button can be pressed again to stop the beverage.



If the brewing of a beverage comprising two products that are not simultaneously brewed is stopped, the machine will brew the second product. For example, if the milk for a cappuccino is stopped, the machine will brew the coffee.

7 SUPPLY AND START UP

7.1 Opening the Upper Lid

The upper protection cover should be removed in order to fill the containers. The cover is a safety device which allows access only to authorised personnel.

Unlock the lid with the special key supplied to remove it.

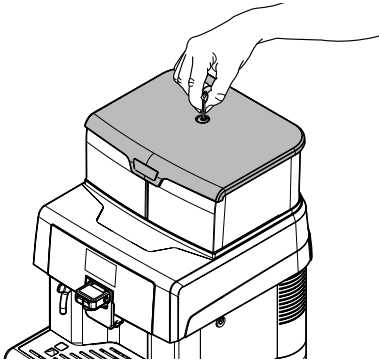

After unlocking the lid, lift and remove it.

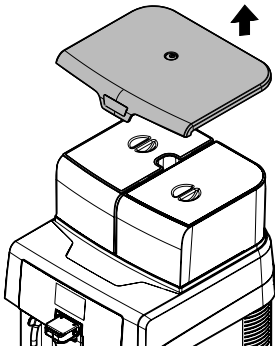

Now the water tank and the coffee bean hopper can be filled.

7.2 Coffee Blends

- We recommend using fresh, non-oily and medium-ground coffee.
- Use an espresso coffee blend.

- Use the special blends for espresso machines to obtain a strong and aromatic coffee.
- Keep coffee in a cool place in an airtight sealed container.

7.3 Coffee Bean Supply

 Only coffee beans must be put into the coffee bean hopper. Ground coffee, instant coffee or any other object may damage the machine.

Remove the protection cover as described in section "Opening the Upper Lid".

Remove the coffee bean hopper lid.

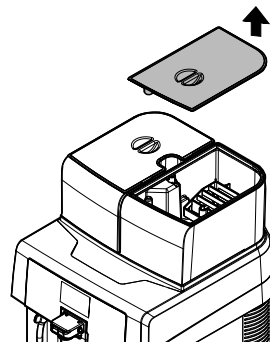

 The coffee bean hopper may be provided with different safety features according to the regulations of the country of use of the machine.

Pour the coffee beans into the hopper.

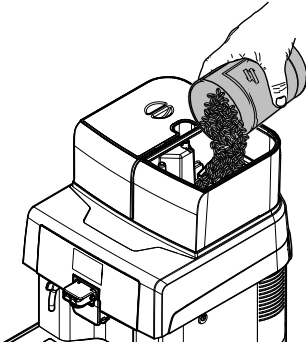

 When filling the coffee bean hopper, use sterile disposable gloves to prevent bacteriological contamination.

 If the water tank is not inserted, check that no coffee beans fall into the tank compartment. If this happens, remove them to avoid any malfunctions.

Refit the coffee bean hopper lid.

Refit the protection cover as described in section "Closing the Upper Lid".

7.4 Filling the Water Tank

 Before using the machine for the first time, wash the water tank carefully. Fill the water tank with fresh drinking water only. Hot or carbonated water, as well as other liquids, will damage the machine.

Remove the protection cover as described in section "Opening the Upper Lid".

Remove the lid from the water tank.

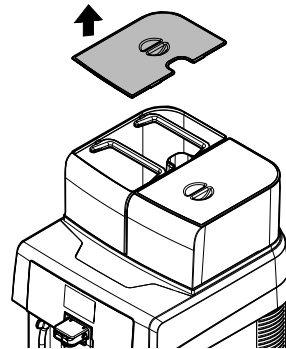

Remove the tank; lift it using the inside handles.

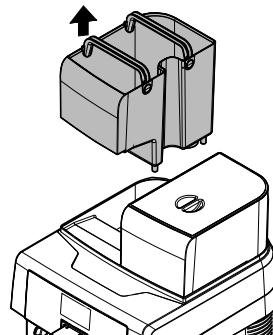

Rinse and fill it with fresh water; do not exceed the level (MAX) indicated on the tank.

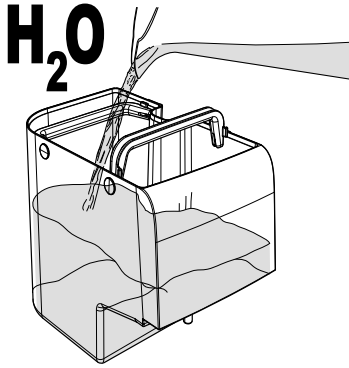

Check how many squares change their colour and then consult the table.

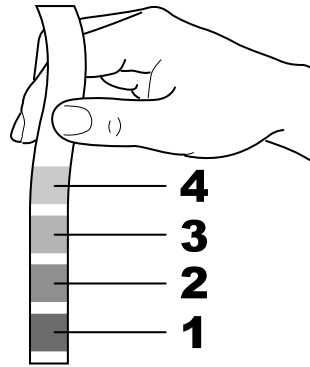

 When filling the water tank, use sterile disposable gloves to prevent bacteriological contamination.

The numbers correspond to the settings indicated in the following machine adjustments.

1	HARDNESS 1 (very soft)
2	HARDNESS 2 (soft)
3	HARDNESS 3 (medium)
4	HARDNESS 4 (hard)

Switch to machine programming mode as described in section "Access to the Technical Menu".

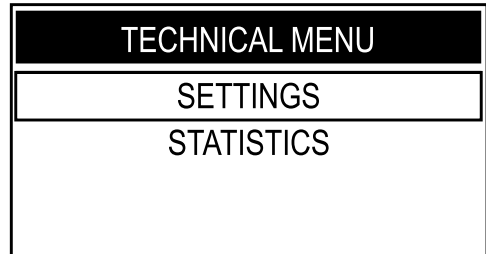

Insert the water tank back into its seat and refit the lid.

Refit the protection cover as described in section "Closing the Upper Lid".

7.5 Measuring and Adjusting Water Hardness

Measuring water hardness is very important in order to correctly manage the "INTENZA+" filter and the frequency with which the machine must be descaled.

Immerse the water hardness test strip in water for 1 second.

 the test strip is only valid for one measurement.

Select the "SETTINGS" option and press the "OK" button.

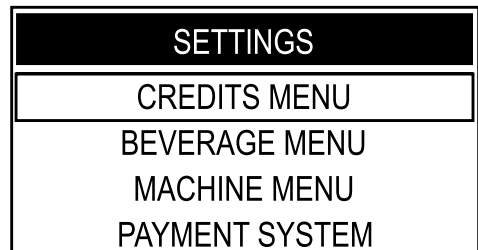

To select the "MACHINE MENU" option, press the "DOWN" button.

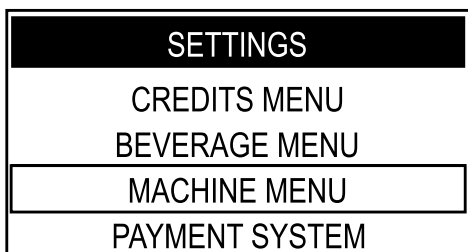

Press the "OK" button to enter.

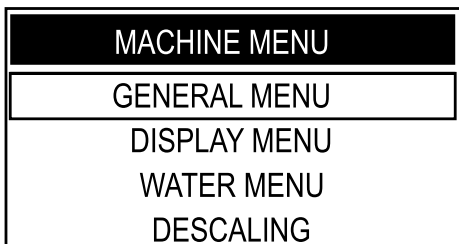

Press the "DOWN" button until the "WATER MENU" option is selected.

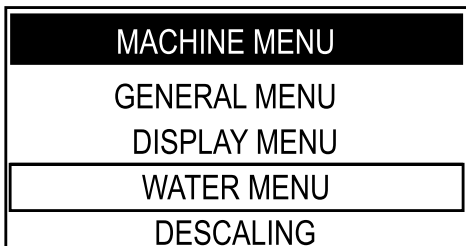

Press the "OK" button to enter.

Press the "OK" button to enter the "HARDNESS" menu.

 The machine is supplied with standard adjustments, suitable for most uses.

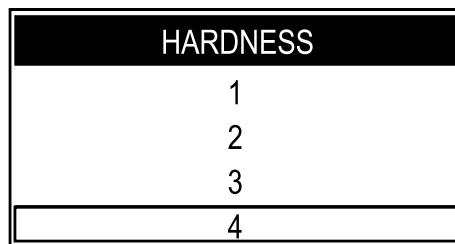

Press the "Up" button to increase the value or the "Down" button to decrease the value.

Press the "OK" button to confirm the selected change.

After adjusting water hardness, install the filter (Intenza+) as described in the following section. Then press the "ESC" button multiple times to exit the programming mode.

7.6 "INTENZA+" Water Filter

Water is a key element for a good espresso coffee. Therefore, it should always be filtered in a professional manner. That is why all Saeco machines can be equipped with the INTENZA+ filter. This filter is easy to use and its sophisticated technology is effective in preventing limescale build-up. This way, water will always be perfect and will give a much more intense aroma to your espresso coffee.

 The "INTENZA+" water filter can be installed only if the machine is NOT connected to the water network.

 The anti-scale filter should be replaced whenever indicated by the machine. Before descaling, remove the anti-scale filter from the water tank.

 Measuring water hardness is very important in order to manage correctly the "INTENZA+" water filter and the frequency with which the machine must be descaled.

Remove the "INTENZA+" water filter from its packaging. The filter should be set according to the measurements performed to set water hardness.

Use the water hardness test strip provided with the machine. Set the "Intenza Aroma System" as specified on the filter package (see section "Measuring and Adjusting Water Hardness").

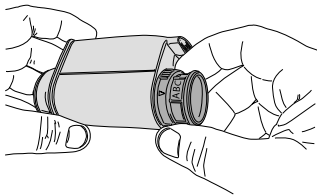

- A** Soft water
- B** Hard water (standard)
- C** Very hard water

Immerse the "INTENZA+" water filter vertically in cold water (with the opening positioned upwards) and gently press its sides to let the air bubbles out.

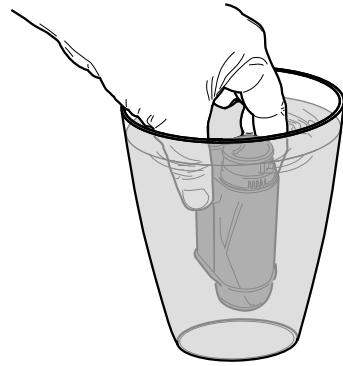

Switch to machine programming mode as described in section "Access to the Technical Menu".

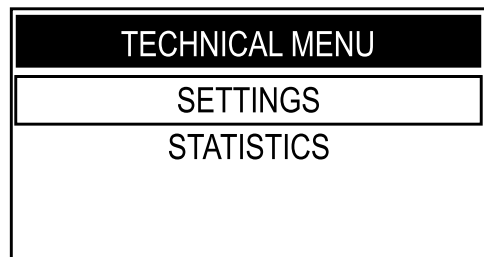

Select the "SETTINGS" option and press the "OK" button.

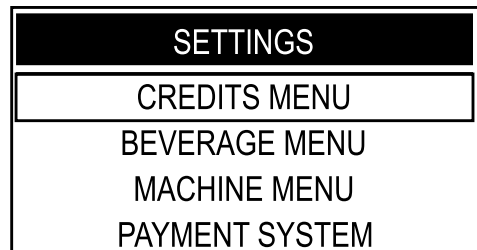

To select the "MACHINE MENU" option, press the "DOWN" button.

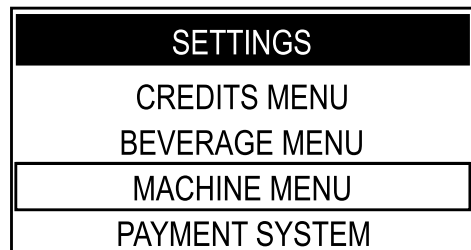

Press the "OK" button to enter.

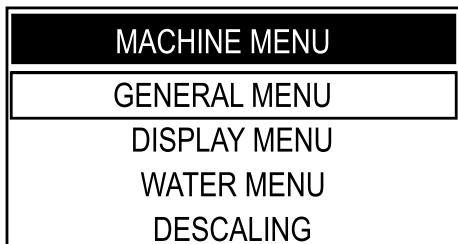

Press the "DOWN" button until the "WATER MENU" option is selected.

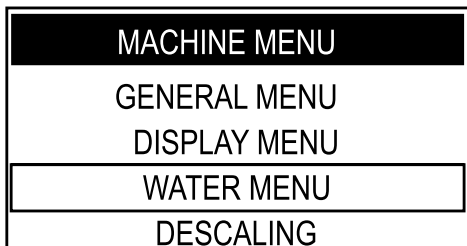

Press the "OK" button to enter.
Press the "DOWN" button until the "ACTIVATE FILTER" option is selected.

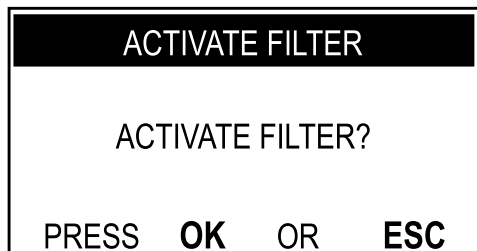

 To exit the procedure, press the "ESC" button.

Press the "OK" button to continue.



Remove the tank from the machine and empty it. Remove the small white filter from the tank and store it in a dry place sheltered from dust.

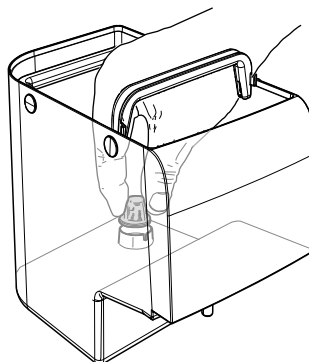

Put the filter into the empty tank. Press it to its limit stop.

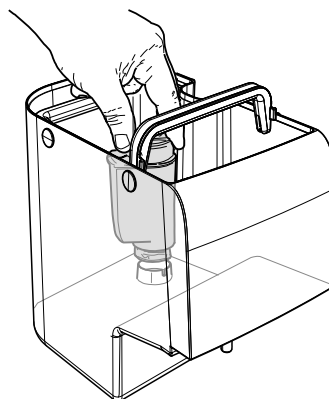

Fill the tank with fresh drinking water and reinsert it into the machine.

Press the "OK" button to confirm the insertion of the new filter.



Remove and empty the drip tray.

When the drip tray is empty, refit it in the machine and press the "OK" button to confirm that the procedure has been completed.



Place a large container under the hot water wand.

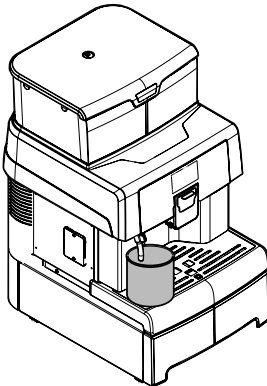

Press the "OK" button to confirm.

Wait until the machine stops dispensing the necessary water to activate the filter.

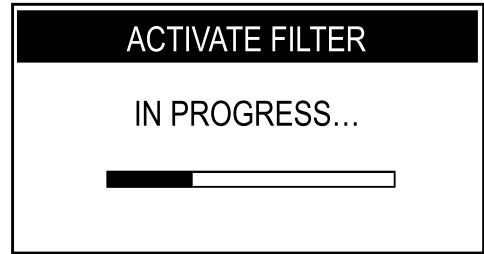

At the end of the cycle, remove the container previously placed under the hot water wand.



At the end of the procedure the display automatically returns to the product dispensing page. If there is no water filter, insert the small white filter previously removed into the water tank.

7.7 Closing the Upper Lid

After refilling and during normal operation, the upper protection cover must always be fitted and locked using the special key in order to prevent access to unauthorised people.

In order to lock the upper lid, position it and close it using the special key supplied.

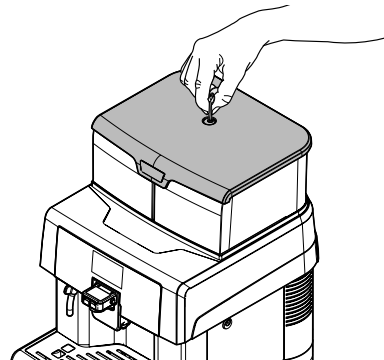

7.8 Coffee Grind Adjustment

⚠ Do not pour ground and/or instant coffee into the coffee bean hopper. Do not put any material other than coffee beans into the hopper.

⚠ The coffee grinder contains moving parts that may be dangerous. Do not insert fingers and/or other objects.

⚠ Turn off the machine by pressing the ON/OFF button and remove the plug from the socket before carrying out any type of operation inside the coffee bean hopper.

The machine allows the coffee grind to be slightly adjusted in order to adapt it to the kind of coffee used. For any adjustments, use the lever located on the inner side of the service compartment.

Open the service compartment door and turn the lever by only one notch. Close the door again and brew 1-2 cups of coffee to verify the changes in the grinding degree. Repeat the procedure until you reach the desired grind setting. The reference marks indicate the grind setting. There are different grind settings to choose from with the following references:

- 1 - Fine grind
- 2 - Coarse grind

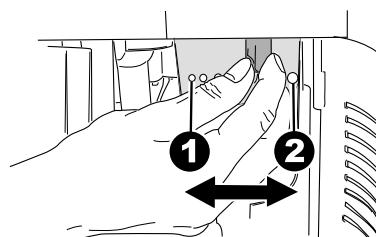

7.9 Adjusting the "Aroma" - Amount of Ground Coffee

The machine allows you to program the amount of coffee to be ground for preparing each cup of coffee.

⚠ The Aroma adjusting lever must only be turned when the coffee grinder is stopped. The adjustment must be performed before brewing coffee.

⚠ DO NOT change the coffee dose if the pre-grinding option is active (set on "ON").

For any adjustments, use the lever located on the inner side of the service compartment.

Open the service compartment door with the appropriate key.

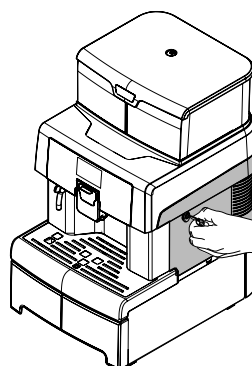

The reference marks indicate the amount of ground coffee which has been set.

You can set different amounts with the following references:

3 - Minimum coffee amount (about 6 grams)

4 - Maximum coffee amount (about 11 grams)

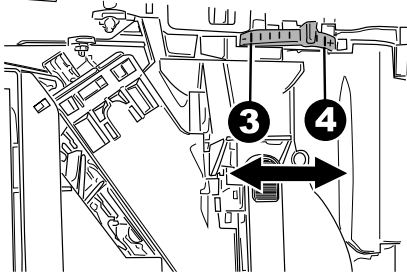

- When using mugs.

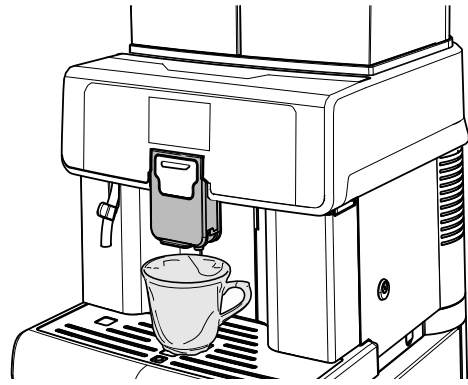

7.10 Adjusting the Coffee Dispensing Spout

Most of the cups and mugs available on the market can be used with this coffee machine.

The height of the dispensing spout can be adjusted to better fit the dimensions of the cups that you wish to use.

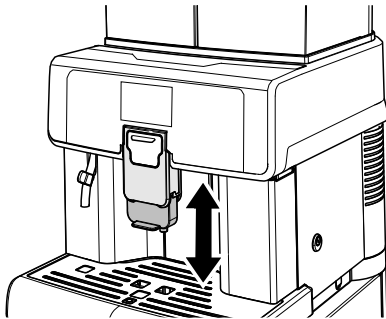

Two cups can be placed under the dispensing spout to brew two cups of coffee at the same time.

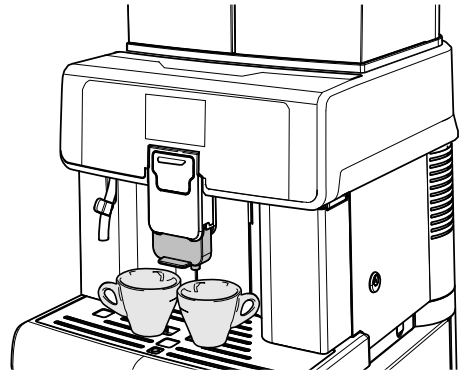



If you want to use tall glasses or mugs, push the dispensing spout to its limit stop. In this case, you can just brew one product at a time.

Manually move the dispensing spout up or down to adjust its height.

The recommended positions are:

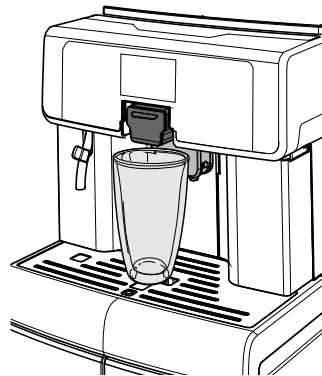
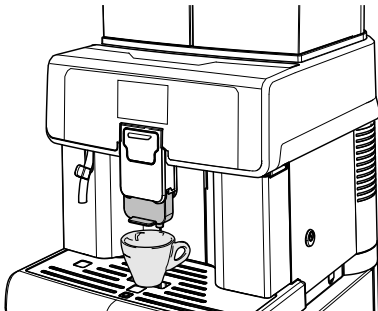
- When using small cups.



 Before brewing any product and/or when bringing the dispensing spout back to its normal position, ensure that it is correctly positioned. This can be evidenced by the **CLICK** indicating correct positioning.

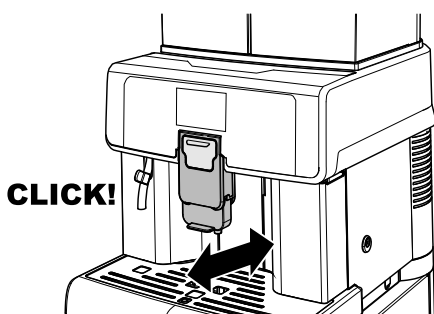

Otherwise, some product might leak out of the dispensing spout.

7.11 Turning on/off the machine

The machine can be turned on/off by pressing the button located to the rear of the machine.

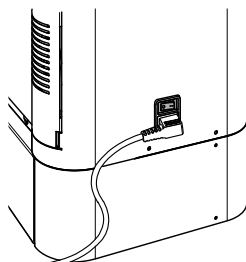

7.12 Setting the Language (Upon First Use)

At first start-up, the desired display language of the messages must be selected and stored. This allows the beverage parameters to be adjusted to the specific taste of the country where the machine is in use.

Select the language by pressing the "DOWN" button or the "UP" button. Press the "OK" button to save the language. The machine starts the system warm-up.

 Upon first use, once warm-up has been completed, the machine primes the circuit and performs a rinse cycle of the internal circuits. During this process, a small amount of water is dispensed. Wait for this cycle to be completed.

7.13 First Use - Use after a Long Period of Inactivity

Refill the machine (follow the instructions above).

Connect the plug of the appliance to the mains (see section "Connection to the Electric Network").
For a perfect Espresso: rinse the coffee circuit if using the machine for the first time or after a long period of inactivity.

These simple operations will allow you to always brew excellent coffee.

They have to be performed:

- at first start-up;
- when the machine remains inactive for a long time (more than 2 weeks).

7.13.1 After a Period of Inactivity

Empty the water tank, wash and rinse it and fill it with fresh water (see section "Filling the Water Tank").

Place a large container under the dispensing spout.

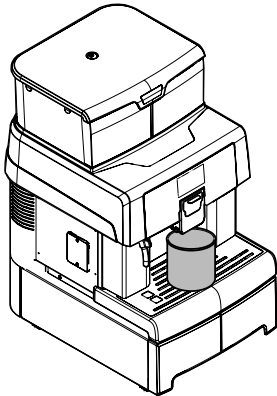

Press the "Coffee" button to start brewing. The machine starts brewing coffee from the dispensing spout. Wait until brewing has been completed and empty the container. Repeat the brewing process 3 times.

Place a container under the hot water wand.

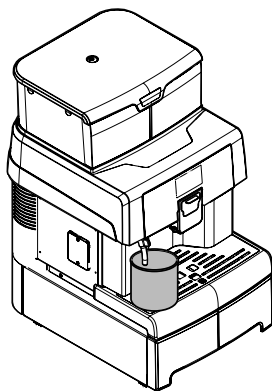

Press the "Hot Water" button to start dispensing HOT WATER.

When the hot water dispensing procedure has been completed, empty the container.

The machine is now ready for use.

7.14 Washing the Parts coming into Contact with Food

Rinse all the parts coming into contact with food.

- Thoroughly wash your hands.
- Prepare a chlorine-based, antibacterial disinfecting solution (the products can be purchased at the chemist's) following the concentrations indicated on the product.
- Remove all product containers from the appliance.
- Remove the container lids and product chutes. Immerse all these parts in the previously prepared solution.

7.15 Using the Appliance

 Before using the machine, read this manual carefully and make sure users are familiar with the machine.

 After the machine has not been used for a certain time, it is recommended to read section "First Use - Use after a Long Period of Inactivity" again, before using the module again.

The beverage selection modes are indicated in chapter "Operation and Use".

8 PROGRAMMING MENU

 This chapter contains instructions on how to set and change the programming parameters of the appliance.

 Therefore it is necessary to carefully read it and to understand the exact sequence of operations before performing them.

 All the operations described in this chapter must be performed exclusively by the service provider or a specialised technician, who shall organise all the operating steps and use only suitable means to ensure strict compliance with the safety regulations in force.

The specialised technician or the service provider can change some of the machine operating parameters to suit the needs of the users.

8.1 Button Description in Programming Mode

Use the buttons described below to scroll the appliance menus.

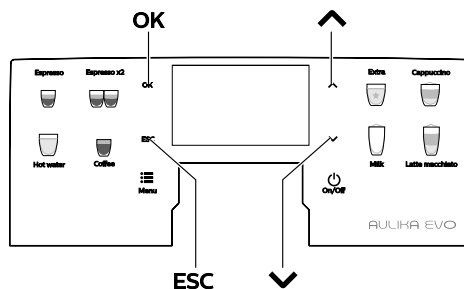

OK	ESC	^	∨
1	2	3	4

Button 1: OK

This button allows you to:

- select the function to display;
- confirm the parameter/value when it is made editable.

Button 2: Esc

This button allows you to:

- go back to the previous menu level;
- exit without changing the edited or selected parameter.

 press it repeatedly to exit programming mode.

Button 3: Up

This button allows you to:

- browse the pages within a menu;
- change the parameters when they are made editable using the "OK" button.

Button 4: Down

This button allows you to:

- browse the pages within a menu;
- change the parameters when they are made editable using the "OK" button.

8.2 User Menu Programming

The structure of the user menu is indicated in section "Structure of the User Menu".

Section "Description of Messages in the User Menu" describes all options in the user menu.

8.2.1 Access to the User Menu

When the machine is "ready for use", access the main menu by pressing the "Menu" button.

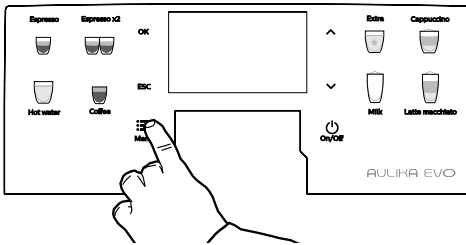

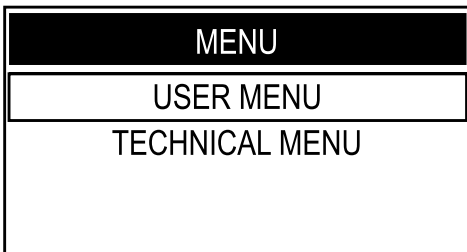

The following screen is displayed:



Select the "USER MENU" option and press the "OK" button.

 The menus should be PASSWORD-protected.

 The PASSWORD will not be requested if set on the default value (0000). It should be changed upon first use to prevent unauthorised access. After this change, the password must be entered each time the display shows:

 In case you do not enter the password within 10 seconds the machine goes back to the previous screen.

Refer to the "Setting the user menu password" section to set the PASSWORD.

 If the PASSWORD is forgotten, you can reset it by entering a PUK code. You have to request the PUK code to the Saeco service centre, who will guide you through the procedure.

8.2.2 Structure of the User Menu

The main options of the user menu are:

MENU ITEM

Brew Group Clean

Cappuccinatore Cleaning

Start Cleaning

Warning Cleaning

8.2.3 Description of Messages in the User Menu

MENU ITEM	Description
Brew Group Clean	This function allows you to perform the brew group wash cycle (see section "Brew Group Cleaning with the "Coffee Oil Remover").
Cappuccinatore Cleaning	This function manages the cleaning cycle of the Cappuccinatore, which is used to prepare milk-based beverages (see section "Thorough Cleaning of the Cappuccinatore"). NOTE: This cleaning cycle is essential for proper operation of the Cappuccinatore.
Start Cleaning	This function starts the Cappuccinatore cleaning cycle as described in the relevant section.
Warning Cleaning	This function activates the display warning message indicating that a Cappuccinatore cleaning cycle should be performed.
Off	With this setting, the warning message is disabled.
On	With this setting, the warning message is enabled; the message is displayed when a cleaning cycle of the Capuccinatore needs to be performed.

8.3 Technical Menu Programming

The structure of the technical menu is detailed in the "Structure of the Technical Menu" section. The "Description of Messages in the Technical Menu" section describes all the options in the technical menu.

8.3.1 Access to the Technical Menu

When the machine is "ready for use", access the main menu by pressing the "Menu" button.

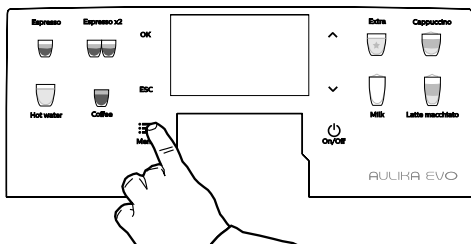

The following screen is displayed:

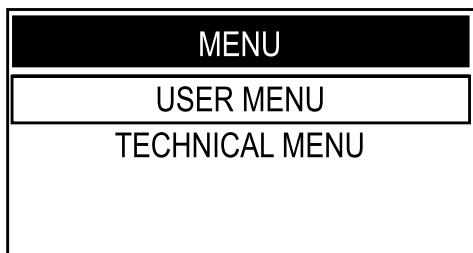

Scroll the main menu until you reach the "Tech Menu" option. Press the "OK" button.

⚠ The menus should be PASSWORD-protected.

⚠ The PASSWORD will not be requested if set on the default value (0000). It should be changed upon first use to prevent unauthorised access. After this change, the password must be entered each time the display shows:

👉 If you do not enter the password within a few seconds, the machine will go back to the previous screen.

Refer to the "Setting the technical menu password" section to set the PASSWORD.



If the PASSWORD is forgotten, you can reset it by entering a PUK code. You have to request the PUK code to the Saeco service centre, who will guide you through the procedure.

8.3.2 Structure of the Technical Menu

This menu allows you to manage certain machine operation parameters.

The main options of the technical menu are:

MENU ITEM
Settings
Credits Menu
ACTIVATE CREDITS
Add Credits
Reset Credits
Show Credits
Beverage Menu
CONFIG. BREWING MODE
Espresso
Coffee
Cappuccino
Latte Macchiato
HOT WATER
milk
EXTRA
LARGE COFFEE
CAFFE LATTE
CONFIG. WITH PARAMETERS
Espresso
Prebrewing
COFFEE TEMPERATURE
COFFEE LENGTH
Default
Coffee
Prebrewing
COFFEE TEMPERATURE
COFFEE LENGTH
Default
Cappuccino
Prebrewing
COFFEE TEMPERATURE
COFFEE LENGTH
MILK QUANTITY
Pause

High Speed Milk
Default
Latte Macchiato
Prebrewing
COFFEE TEMPERATURE
COFFEE LENGTH
MILK QUANTITY
Pause
High Speed Milk
Default
HOT WATER
WATER QUANTITY
Default
milk
MILK QUANTITY
Default
EXTRA
LARGE COFFEE
Prebrewing
COFFEE TEMPERATURE
COFFEE LENGTH
Default
AMERICAN COFFEE
COFFEE TEMPERATURE
COFFEE LENGTH
WATER PERCENT COFFEE
Default
CAFFE LATTE
Prebrewing
COFFEE TEMPERATURE
COFFEE LENGTH
MILK QUANTITY
High Speed Milk
Default
steam
Machine Menu
General Menu
Tone
Ecomode
Stand-by Settings
Coffee Ground Manage
Coffee grounds drawer full alarm
Coffee Grounds
Pre Grinding
Set Temperature Offset
SET USER PASSWORD
SET TECHNICAL PASSWORD
Display Menu
Language
BRIGHTNESS
Contrast
Display Logo
Water Menu
Hardness
Water Net
Enable Filter
Activate Filter
Descaling
Start Descale
Descale Warning

MENU ITEM

Factory settings
Payment system
DECOUNT LED BEVERAGE
Price Menu
Espresso
Espresso x2
Coffee
LARGE COFFEE
AMERICAN COFFEE
HOT WATER
Cappuccino
Latte Macchiato
milk
CAFFE LATTE
Statistics
PRODUCT COUNTERS
Total
Espresso
Espresso x2
Coffee
LARGE COFFEE
AMERICAN COFFEE
HOT WATER
Cappuccino
Latte Macchiato
milk
CAFFE LATTE
TOTAL COFFEE PRODUCTS
PARTIAL RESETTABLE
Espresso
Espresso x2
Coffee
LARGE COFFEE
AMERICAN COFFEE
HOT WATER
Cappuccino
Latte Macchiato
milk
CAFFE LATTE
Counters Reset
ERROR COUNTERS
ERRORS LOG
RESET ERRORS
WATER COUNTERS
DESCALING CYCLE
SINCE LAST
SINCE SECOND LAST
SINCE THIRD LAST
NUMBER OF EXECUTION
BREW GROUP CLEAN
NUMBER OF EXECUTION
SINCE LAST
SINCE PRODUCTION
WATER FILTER
SINCE LAST RESET
NUMBER OF RESET

8.3.3 Description of Messages in the Technical Menu

MENU ITEM	Description
Settings	This menu allows you to access all machine configuration parameters
Credits Menu	This menu allows you to activate the use of virtual credits, load them onto the machine, reset them and view them on the "Ready for use" screen
ACTIVATE CREDITS	This menu allows you to enable the system that checks for any virtual credits on the machine, to prevent the brewing of unwanted products. This check will not be performed when dispensing hot water, milk or steam
Off	This setting disables the virtual credits checking system
On	This setting enables the virtual credits checking system
Add Credits	This function allows you to load virtual credits onto the machine
Reset Credits	This function allows you to reset all virtual credits on the machine
Show Credits	This function allows the credits to be displayed on the main "Ready for use" page. NOTE: The "ACTIVATE CREDITS" setting must be set to "ON", otherwise the machine will not display the credits, regardless of the selected parameter
Off	To disable credit display. NOTE: The machine will always display the number of credits when the minimum level of 30 credits is reached, so that the user can contact the service provider
On	To enable credit display
Beverage Menu	This menu allows you to adjust the characteristic parameters of the beverages dispensed by the machine
CONFIG. BREWING MODE	This menu allows you to adjust the beverage doses in brewing mode or to save the desired dose during the dispensing cycle
Espresso	An Espresso will be brewed once the length of the beverage has been saved NOTE: the length of the beverage may be numerically adjusted using the "CONFIG. WITH PARAMETERS" menu
Coffee	A Coffee will be brewed once the length of the beverage has been saved NOTE: the length of the beverage may be numerically adjusted using the "CONFIG. WITH PARAMETERS" menu
Cappuccino	A Cappuccino will be brewed once the length of the coffee part and milk part has been saved NOTE: the length of the beverage may be numerically adjusted using the "CONFIG. WITH PARAMETERS" menu
Latte Macchiato	A Latte Macchiato will be brewed once the length of the coffee part and milk part has been saved NOTE: the length of the beverage may be numerically adjusted using the "CONFIG. WITH PARAMETERS" menu
HOT WATER	Hot water will be dispensed once the length of the beverage has been saved NOTE: the length of the beverage may be numerically adjusted using the "CONFIG. WITH PARAMETERS" menu
milk	Milk will be dispensed once the length of the beverage has been saved NOTE: the length of the beverage may be numerically adjusted using the "CONFIG. WITH PARAMETERS" menu

MENU ITEM	Description
EXTRA	This menu allows you to save Extra beverages in beverage mode
LARGE COFFEE	A Large Coffee will be brewed once the length of the beverage has been saved NOTE: the length of the beverage may be numerically adjusted using the "CONFIG. WITH PARAMETERS" menu
CAFFE LATTE	A Caffe Latte will be brewed once the length of the coffee part and milk part has been saved NOTE: the length of the beverage may be numerically adjusted using the "CONFIG. WITH PARAMETERS" menu
CONFIG. WITH PARAMETERS	This menu allows you to change the characteristic configuration parameters of each beverage
Espresso Prebrewing	To manage the Espresso beverage brewing parameters. Pre-brewing: the coffee is slightly dampened before brewing so as to bring out the full aroma of the coffee and to acquire an excellent flavour pre-brewing is not performed.
Off	active.
Low	longer in order to bring out the coffee taste.
High	longer in order to bring out the coffee taste.
COFFEE TEMPERATURE	This section allows the coffee brewing temperature to be adjusted
Low	lowest brewing temperature
Normal	standard brewing temperature
High	highest brewing temperature
COFFEE LENGTH	This section allows you to program the amount of coffee to be brewed for each selected beverage. The bar allows you to set the exact amount of coffee to be brewed (the value is measured in turbine pulses). NOTE: alternatively, this parameter may be configured while brewing using the "CONFIG. BREWING MODE" menu
Default	The original standard values assigned by the manufacturer to each beverage can be reset. After selecting this function, the customised individual beverage settings are deleted.
Coffee Prebrewing	To manage the Coffee beverage brewing parameters. Pre-brewing: coffee is slightly dampened before brewing so as to bring out the full aroma of the coffee that acquires an excellent taste. pre-brewing is not performed.
Off	active.
Low	longer in order to bring out the coffee taste.
High	longer in order to bring out the coffee taste.
COFFEE TEMPERATURE	This section allows the coffee brewing temperature to be adjusted
Low	lowest brewing temperature
Normal	standard brewing temperature
High	highest brewing temperature
COFFEE LENGTH	This section allows you to program the amount of coffee to be brewed for each selected beverage. The bar allows you to set the exact amount of coffee to be brewed (the value is measured in turbine pulses). NOTE: alternatively, this parameter may be configured while brewing using the "CONFIG. BREWING MODE" menu
Default	The original standard values assigned by the manufacturer to each beverage can be reset. After selecting this function, the customised individual beverage settings are deleted.
Cappuccino	To manage the Cappuccino beverage brewing parameters.

MENU ITEM	Description
Prebrewing	Pre-brewing: coffee is slightly dampened before brewing so as to bring out the full aroma of the coffee that acquires an excellent taste.
Off	pre-brewing is not performed.
Low	active.
High	longer in order to bring out the coffee taste.
COFFEE TEMPERATURE	This section allows the coffee brewing temperature to be adjusted
Low	lowest brewing temperature
Normal	standard brewing temperature
High	highest brewing temperature
COFFEE LENGTH	This section allows you to program the amount of coffee to be brewed for each selected beverage. The bar allows you to set the exact amount of coffee to be brewed (the value is measured in turbine pulses). NOTE: alternatively, this parameter may be configured while brewing using the "CONFIG. BREWING MODE" menu
MILK QUANTITY	This setting can only be adjusted for beverages containing milk and allows you to program the amount of milk dispensed for each selected beverage. The bar allows you to set the exact amount of milk to be dispensed (the value is measured in seconds). NOTE: alternatively, this parameter may be configured while brewing using the "CONFIG. BREWING MODE" menu
Pause	This value between 0 and 60 secs - if different from zero - performs a pause of the value set in seconds to stratify the milk before brewing the coffee.
High Speed Milk	This setting can only be adjusted for beverages containing milk and allows the machine to dispense milk and coffee at the same time.
Off	Milk and coffee are dispensed in two separate steps. NOTE: in this case, the various dispensing stages (coffee or milk) can be individually stopped.
On	Milk and coffee are dispensed at the same time. NOTE: in this case, the user can only stop dispensing the beverage as a whole. Setting ECOMODE to OFF brings down the dispensing time of mixed products.
Default	The original standard values assigned by the manufacturer to each beverage can be reset. After selecting this function, the customised individual beverage settings are deleted.
Latte Macchiato	To manage the Latte Macchiato beverage brewing parameters.
Prebrewing	Pre-brewing: coffee is slightly dampened before brewing so as to bring out the full aroma of the coffee that acquires an excellent taste.
Off	pre-brewing is not performed.
Low	active.
High	longer in order to bring out the coffee taste.
COFFEE TEMPERATURE	This section allows the coffee brewing temperature to be adjusted
Low	lowest brewing temperature
Normal	standard brewing temperature
High	highest brewing temperature
COFFEE LENGTH	This section allows you to program the amount of coffee to be brewed for each selected beverage. The bar allows you to set the exact amount of coffee to be brewed (the value is measured in turbine pulses). NOTE: alternatively, this parameter may be configured while brewing using the "CONFIG. BREWING MODE" menu

MENU ITEM	Description
MILK QUANTITY	This setting can only be adjusted for beverages containing milk and allows you to program the amount of milk dispensed for each selected beverage. The bar allows you to set the exact amount of milk to be dispensed (the value is measured in seconds). NOTE: alternatively, this parameter may be configured while brewing using the "CONFIG. BREWING MODE" menu
Pause	This value between 0 and 60 secs - if different from zero - performs a pause of the value set in seconds to stratify the milk before brewing the coffee.
High Speed Milk	This setting can only be adjusted for beverages containing milk and allows the machine to dispense milk and coffee at the same time.
Off	Milk and coffee are dispensed in two separate steps. NOTE: in this case, the various dispensing stages (coffee or milk) can be individually stopped.
On	Milk and coffee are dispensed at the same time. NOTE: in this case, the user can only stop dispensing the beverage as a whole. Setting ECOMODE to OFF brings down the dispensing time of mixed products.
Default	The original standard values assigned by the manufacturer to each beverage can be reset. After selecting this function, the customised individual beverage settings are deleted.
HOT WATER WATER QUANTITY	To manage the Hot water beverage dispensing parameters. This setting can only be used to adjust Hot Water and allows you to program the amount of water to be dispensed each time the corresponding button is pressed. The bar allows you to set the exact amount of water to be dispensed (the value is measured in turbine pulses).
Default	The original standard values assigned by the manufacturer to each beverage can be reset. After selecting this function, the customised individual beverage settings are deleted.
milk MILK QUANTITY	To manage the Milk beverage dispensing parameters This setting can only be adjusted for beverages containing milk and allows you to program the amount of milk dispensed for each selected beverage. The bar allows you to set the exact amount of milk to be dispensed (the value is measured in seconds). NOTE: alternatively, this parameter may be configured while brewing using the "CONFIG. BREWING MODE" menu
Default	The original standard values assigned by the manufacturer to each beverage can be reset. After selecting this function, the customised individual beverage settings are deleted.
EXTRA LARGE COFFEE	To adjust the parameters of the Extra beverages. To manage the Large Coffee beverage brewing parameters
Prebrewing	Pre-brewing: the coffee is slightly dampened before brewing so as to bring out the full aroma of the coffee and to acquire an excellent flavour pre-brewing is not performed.
Off	active.
Low	longer in order to bring out the coffee taste.
High	
COFFEE TEMPERATURE	This section allows the coffee brewing temperature to be adjusted
Low	lowest brewing temperature
Normal	standard brewing temperature
High	highest brewing temperature

MENU ITEM	Description
COFFEE LENGTH	This section allows you to program the amount of coffee to be brewed for each selected beverage. The bar allows you to set the exact amount of coffee to be brewed (the value is measured in turbine pulses). NOTE: alternatively, this parameter may be configured while brewing using the "CONFIG. BREWING MODE" menu
Default	The original standard values assigned by the manufacturer to each beverage can be reset. After selecting this function, the customised individual beverage settings are deleted.
AMERICAN COFFEE	To manage the American Coffee beverage brewing parameters
COFFEE TEMPERATURE	This section allows the coffee brewing temperature to be adjusted
Low	lowest brewing temperature
Normal	standard brewing temperature
High	highest brewing temperature
COFFEE LENGTH	This section allows you to program the amount of coffee to be brewed for each selected beverage. The bar allows you to set the exact amount of coffee to be brewed (the value is measured in turbine pulses). NOTE: alternatively, this parameter may be configured while brewing using the "CONFIG. BREWING MODE" menu
WATER PERCENT COFFEE	This section allows you to program the percentage of water to dispense while preparing an American Coffee beverage. If the Coffee Length is set at 100 ml and the Coffee Water Percentage is set at 30%, 30 ml of water and 70 ml of coffee will be dispensed.
Default	The original standard values assigned by the manufacturer to each beverage can be reset. After selecting this function, the customised individual beverage settings are deleted.
CAFFE LATTE	To manage the Caffe latte beverage brewing parameters
Prebrewing	Pre-brewing: the coffee is slightly dampened before brewing so as to bring out the full aroma of the coffee and to acquire an excellent flavour
Off	pre-brewing is not performed.
Low	active.
High	longer in order to bring out the coffee taste.
COFFEE TEMPERATURE	This section allows the coffee brewing temperature to be adjusted
Low	lowest brewing temperature
Normal	standard brewing temperature
High	highest brewing temperature
COFFEE LENGTH	This section allows you to program the amount of coffee to be brewed for each selected beverage. The bar allows you to set the exact amount of coffee to be brewed (the value is measured in turbine pulses). NOTE: alternatively, this parameter may be configured while brewing using the "CONFIG. BREWING MODE" menu
MILK QUANTITY	This setting can only be adjusted for beverages containing milk and allows you to program the amount of milk dispensed for each selected beverage. The bar allows you to set the exact amount of milk to be dispensed (the value is measured in seconds). NOTE: alternatively, this parameter may be configured while brewing using the "CONFIG. BREWING MODE" menu
High Speed Milk	This setting can only be adjusted for beverages containing milk and allows the machine to dispense milk and coffee at the same time.

MENU ITEM	Description
Off	Milk and coffee are dispensed in two separate steps. NOTE: in this case, the various dispensing stages (coffee or milk) can be individually stopped.
On	Milk and coffee are dispensed at the same time. NOTE: in this case, the user can only stop dispensing the beverage as a whole. Setting ECOMODE to OFF brings down the dispensing time of mixed products.
Default	The original standard values assigned by the manufacturer to each beverage can be reset. After selecting this function, the customised individual beverage settings are deleted.
steam	To enable/disable the machine's Steam function.
Off	To disable the Steam function (it is not displayed in the list of "Extra" products, see "Extra Products" section).
On	To enable the Steam function (it is displayed in the list of "Extra" products, see "Extra Products" section).
Machine Menu	This menu manages general machine operation and maintenance parameters.
General Menu	To change the machine operating settings.
Tone	This function allows you to activate/deactivate the acoustic alarms.
Off	To deactivate the acoustic alarms.
On	To activate the acoustic alarms.
Ecomode	This function manages the activation of the machine boilers in order to save energy. The function is set by default to «OFF».
Off	This function activates all the boilers at every machine start-up to allow instant preparation of all products. In this mode, the power consumption is higher because the machine is always ready for use.
On	In this mode, only the coffee boiler is activated at machine start-up. The machine saves energy but needs longer time to dispense milk-based beverages. The appliance is factory preset so that this setting is not enabled by default.
Stand-by Settings	To set the time interval for the machine to go into stand-by mode after the last brewing. The default time value is «after 30 minutes».
15 minutes	Once the set time has elapsed, the machine goes into stand-by mode.
30 minutes	Press any button to turn the machine back on.
60 minutes	After performing the function diagnostics and the warm-up phase, the machine is again ready for use.
180 minutes	
Off	When this parameter is set to "OFF", the machine stays active.
Coffee Ground Manage	This function allows you to manage the coffee grounds produced by the machine.
Coffee grounds drawer full alarm	It is possible to set the machine so that it alerts the user when the coffee grounds drawer needs to be emptied as it has reached the maximum number of grounds set under the "Coffee Grounds" function.
Off	alarm disabled
On	alarm enabled
Coffee Grounds	You can set the maximum number of grounds that the drawer can contain before requiring to be emptied.
Pre Grinding	To activate the pre-grinding function for a coffee yet to be selected in order to speed up coffee brewing time.
Off	With this setting, the pre-grinding function is disabled.
On	With this setting, the pre-grinding function is enabled; the first time it is used, the machine grinds the selected coffee as well as the one that will be selected at a later stage, so as to instantly brew the next coffee.
Set Temperature Offset	It is possible to increase/decrease the coffee temperature.

MENU ITEM	Description
SET USER PASSWORD	To set the user menu access PASSWORD. NOTE: if the PASSWORD is set to (0000), it will not be requested upon access. If the PASSWORD is forgotten, a restoring procedure must be started. Please contact customer service.
SET TECHNICAL PASSWORD	To set the technical menu access PASSWORD. NOTE: if the PASSWORD is set to (0000), it will not be requested upon access. If the PASSWORD is forgotten, a restoring procedure must be started. Please contact customer service. Warning: The technical menu password also allows you to access the user menu
Display Menu	With this menu, the menu language and the display brightness and contrast can be set.
Language	This setting allows you to select one of the following 17 user interface languages: - ITALIAN - ENGLISH - GERMAN - FRENCH - SPANISH - PORTUGUESE - DUTCH - POLISH - SWEDISH - BULGARIAN - HUNGARIAN - CZECH - SLOVENIAN - ROMANIAN - GREEK - RUSSIAN - KOREAN The currently selected language is displayed upon accessing the page. The language can be changed with the correct controls.
BRIGHTNESS	To set the correct display brightness according to room illumination.
Contrast	To set the correct display contrast according to room illumination.
Display Logo	To display the chosen logo during certain stages of machine use:
Standard	The standard logo is displayed.
Bean	Coffee beans are displayed as the logo.
Custom	A customized logo is displayed. The logo can only be customized using the dedicated tool to be requested to the manufacturer.
Water Menu	This menu allows the correct water parameters for coffee brewing to be set.
Hardness	To change the machine water hardness setting. With the "Hardness" function you can adjust your machine to the level of hardness of the water you use, so that the machine will request descaling at the right time. Measure water hardness as shown in section "Measuring and Adjusting Water Hardness".

MENU ITEM	Description
Water Net	To activate the function that enables machine operation with the water network (only for models designed accordingly). NOTE: Use this function with utmost care, as a wrong setting may cause malfunctions. The "ON" option must only be activated if the "Water Network" kit is installed and connected properly. Using it under any other conditions will result in a machine failure. When the "ON" option is selected the "ENABLE FILTER" and "ACTIVATE FILTER" functions will be hidden and will not be available for selection.
Off	With this setting, the machine will work only if the tank is installed.
On	With this setting, the machine will work using water from the water network.
Enable Filter	To activate/deactivate the water filter replacement warning. By activating this function, the machine notifies the user when the water filter should be replaced. This function is visible only if the "WATER NET" function is set to OFF.
Off	Warning disabled.
On	Warning enabled (this value is automatically set when the filter is activated).
Activate Filter	To activate the filter after its installation or replacement. Refer to section ""INTENZA+" Water Filter" to correctly install and/or replace it. This function is visible only if the "WATER NET" function is set to OFF.
Descaling	This function allows you to perform the descaling cycle (see section "Descaling").
Start Descale	This function starts the descaling cycle as described in the relevant section.
Descale Warning	This function activates the display warning message indicating that the machine should be descaled.
Off	With this setting, the warning message is disabled.
On	With this setting, the warning message is enabled; the message is displayed when the machine needs to be descaled.
Factory settings	This function allows all factory settings to be restored. NOTE: this section allows the factory settings of the machine menu personal settings to be restored.
Payment system	This menu matches the price lines to the various beverages and allows you to illuminate the beverage buttons regardless of the availability of credit for brewing
DISCOUNT LED BEVERAGE	If enabled, this function illuminates the beverage buttons regardless of whether or not there is credit available for brewing
Price Menu	This menu allows you to set the price of the products that the machine can dispense. NOTE: Price management is the same for all products. For each product, the machine detects 3 price lines: 0: free product (no payment is required); 1: product that can only be dispensed once the amount (1) shown on the coiner has been reached; 2: product that can only be dispensed once the amount (2) shown on the coiner (normally higher than amount 1) has been reached. Prices must be managed on the coiner or on the "Rfid" system as described in the relevant manuals, and cannot be controlled by the machine.
Espresso	To manage the price of espresso.
Espresso x2	To manage the price of espresso x2.
Coffee	To manage the price of Coffee.
LARGE COFFEE	To manage the price of Large Coffee.
AMERICAN COFFEE	To manage the price of American Coffee
HOT WATER	To manage the price of Hot water
Cappuccino	To manage the price of cappuccino.

MENU ITEM	Description
Latte Macchiato	To manage the price of Latte Macchiato.
milk	To manage the price of Milk.
CAFFE LATTE	To manage the price of Caffè Latte.
Statistics	This function allows the user to view: - Product Counters - Error counters - Descaling and Washing counters
PRODUCT COUNTERS	This function allows the user to view the number of products dispensed by the machine, distinguished according to the beverage type
Total	In this section, the user can view the total number of beverages dispensed since the machine was started up
Espresso	Total no. of espressos dispensed.
Espresso x2	Total no. of espressos x2 dispensed.
Coffee	Total no. of coffees dispensed.
LARGE COFFEE	Total no. of large coffees dispensed.
AMERICAN COFFEE	Total no. of American coffees dispensed.
HOT WATER	Total no. of hot waters dispensed.
Cappuccino	Total no. of cappuccinos dispensed.
Latte Macchiato	Total no. of latte macchiato dispensed.
milk	Total no. of milks dispensed.
CAFFE LATTE	Total no. of caffè lattes dispensed.
TOTAL COFFEE PRODUCTS	Total no. of coffee products dispensed.
PARTIAL RESETTABLE	In this section, the user can view the total number of beverages dispensed since the last time these "partial" counters were reset
Espresso	No. of espresso coffee cups brewed from the last RESET.
Espresso x2	No. of espressos x2 dispensed since the last RESET.
Coffee	No. of coffees dispensed since the last RESET.
LARGE COFFEE	No. of large coffees dispensed since the last RESET.
AMERICAN COFFEE	No. of American coffees dispensed since the last RESET.
HOT WATER	No. of hot waters dispensed since the last RESET.
Cappuccino	No. of cappuccinos dispensed since the last RESET.
Latte Macchiato	No. of latte macchiato cups brewed from the last RESET.
milk	No. of milks dispensed since the last RESET.
CAFFE LATTE	No. of caffè lattes dispensed since the last RESET.
Counters Reset	To reset all the "partial" dispensed beverage counters.
ERROR COUNTERS	This function allows you to manage and view the machine errors: - ERRORS LOG - RESET ERRORS
ERRORS LOG	This function allows you to view the machine errors.
RESET ERRORS	This function resets the error list
WATER COUNTERS	In this section you can view information about how to use the machine, including maintenance operations, filter installation and water usage in general
DESCALING CYCLE	This section displays the statistics pertaining to the descaling cycles enabled on the machine
SINCE LAST	This indicates the number of turbine pulses processed since the last time the descaling washing phase was completed or cancelled by the user
SINCE SECOND LAST	This indicates the number of turbine pulses processed between the second-to-last time and the last time the descaling washing phase was completed or cancelled by the user
SINCE THIRD LAST	This indicates the number of turbine pulses processed between the third-to-last time and the second-to-last time the descaling washing phase was completed or cancelled by the user
NUMBER OF EXECUTION	This indicates the total number of descaling cycles performed by the machine, including those cancelled by the user
BREW GROUP CLEAN	This function allows the user to view the counters relating to the brew group washing cycles performed.

MENU ITEM	Description
NUMBER OF EXECUTION	Indicates the number of brew group washing cycles performed
SINCE LAST	This indicates the number of turbine pulses processed since the last time a full brew group wash cycle was completed
SINCE PRODUCTION	This indicates the total number of turbine pulses processed by the machine since it was started up
WATER FILTER	This function allows the user to view the counters relating to the water filters.
SINCE LAST RESET	This indicates the number of turbine pulses processed since the activation of the last filter installed.
NUMBER OF RESET	This indicates the number of times a new filter has been installed

8.4 Setting the user menu password

The PASSWORD must be set by the service provider in order to prevent access by unauthorised personnel who could change the machine settings and cause malfunctions.

To set the PASSWORD, proceed as follows:
Switch to machine programming mode as described in section "Access to the Technical Menu".

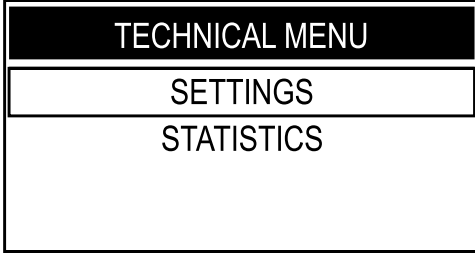

Select the "SETTINGS" option and press the "OK" button.

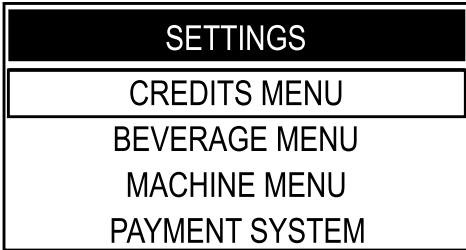

To select the "MACHINE MENU" option, press the "DOWN" button.

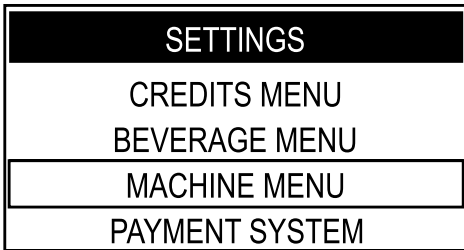

Press the "OK" button to enter.

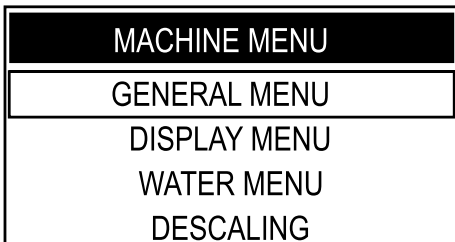

Press the "OK" button to access the "GENERAL MENU".

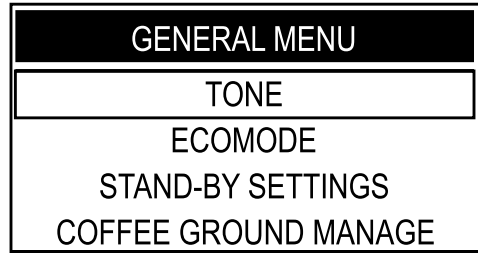

Press the "DOWN" button until the "SET USER PASSWORD" option is selected.

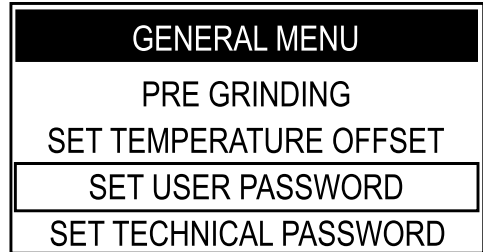

Press the "OK" button to enter.

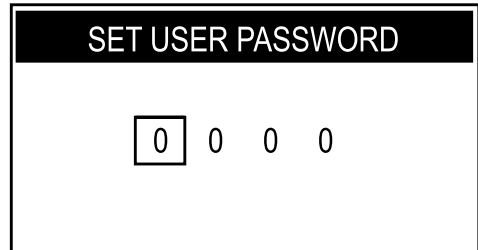

Now the PASSWORD can be set.

Press the "DOWN" button or the "UP" button to set the desired number.

Press the "OK" button to confirm the highlighted number and to move on to the next number.

Carry out the procedures described in the previous steps to set the chosen numbers.

Here is an example that explains the procedure.

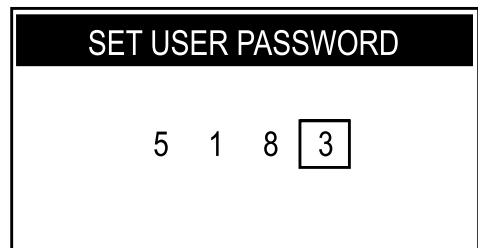

When the "OK" button is pressed on the last number, the machine saves the code and displays the following page.

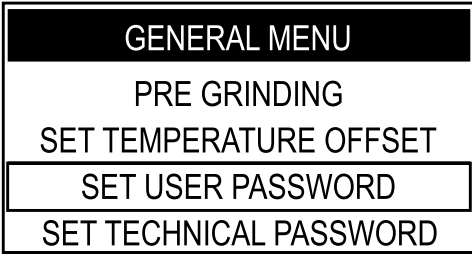

Press the "ESC" button several times to exit; you will now need to enter the PASSWORD to access the user menu.

8.5 Setting the technical menu password

The PASSWORD must be set by the service provider in order to prevent access by unauthorised personnel who could change the machine settings and cause malfunctions.

To set the PASSWORD, proceed as follows:
Switch to machine programming mode as described in section "Access to the Technical Menu".

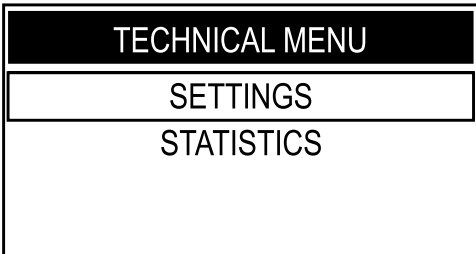

Select the "SETTINGS" option and press the "OK" button.

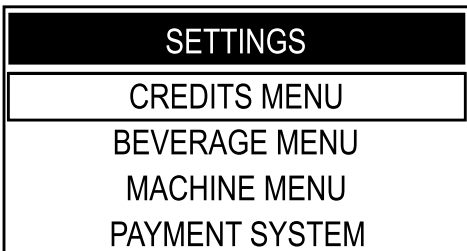

To select the "MACHINE MENU" option, press the "DOWN" button.

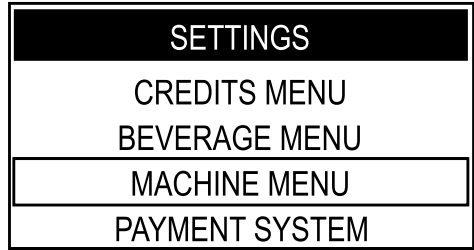

Press the "OK" button to enter.

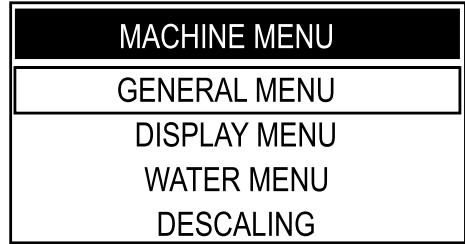

Press the "OK" button to access the "GENERAL MENU".

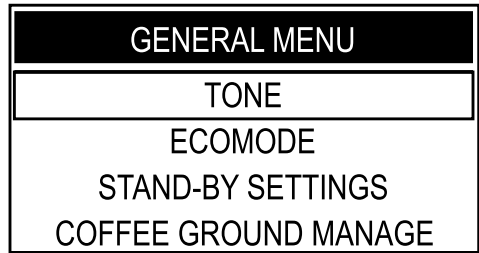

Press the "DOWN" button until the "SET TECHNICAL PASSWORD" option is selected.

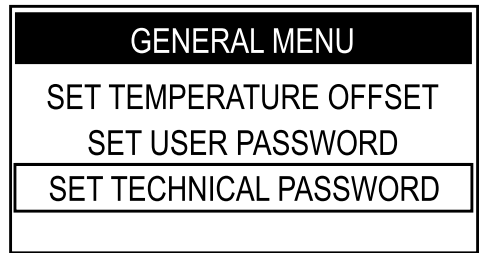

Press the "OK" button to enter.

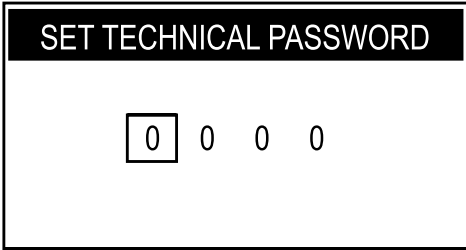

Now the PASSWORD can be set.

Press the "DOWN" button or the "UP" button to set the desired number.

Press the "OK" button to confirm the highlighted number and to move on to the next number.

Carry out the procedures described in the previous steps to set the chosen numbers.

Here is an example that explains the procedure.

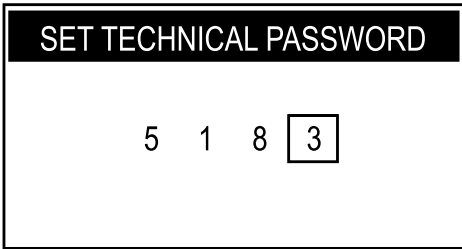

When the "OK" button is pressed on the last number, the machine saves the code and displays the following page.

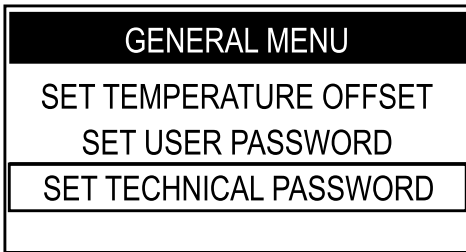



Press the "ESC" button several times to exit; you will now need to enter the PASSWORD to access the technical menu.

 The technical menu password also allows you to access the user menu.

9 OPERATION AND USE

 The use by children older than 8 years or by persons with reduced physical, mental or sensory abilities or with lack of experience and skills is allowed, provided that they are supervised or instructed on how to use the appliance correctly and that they understand the hazards involved.

 Children must not play with the appliance. Children must not carry out any cleaning and maintenance operations without being monitored.

 For hygienic reasons, after the machine has not been used for a long time, it is recommended to thoroughly rinse the circuit.

9.1 Turning on the Machine

 Connection to the power supply should be carried out exclusively by the service provider!

 Ensure that the upper lid is always locked.

 Check that the dispensing spout is correctly installed. Move it horizontally until you hear the **CLICK** indicating correct positioning. Otherwise, some product might leak out of the dispensing spout.

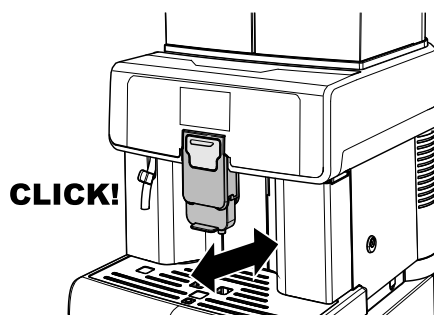

Before turning on the machine, ensure that the plug is correctly inserted in the power socket. To turn on the machine, move the power button on the back of the machine to "I".

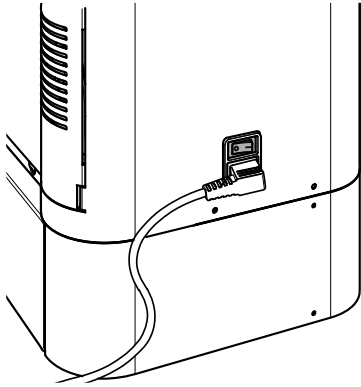

After carrying out a check cycle, the machine goes into stand-by mode. During this phase, the "Stand-by" button is flashing. To turn on the machine simply press the "Stand-by" button. This function may be disabled by a specialised technician.

Once warm-up has been completed, the machine performs a rinse cycle of the internal circuits. A small amount of hot water is dispensed during this process. Wait for this cycle to be completed.

The machine may feature a payment system installed by the service provider.

If some or all of the machine buttons are off after the preparation steps, the corresponding products can only be dispensed after paying the vend price.

Pay the vend price before dispensing any beverage.

Prices are set independently by the service provider.

9.2 Warm-up and Rinsing

Upon start-up, the machine activates the warm-up phase. Wait until it is completed.

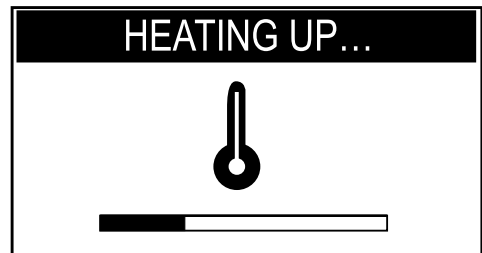

The progress bar indicates that the machine is heating up the system.

Once warm-up has been completed, the machine performs a rinse cycle of the internal circuits.

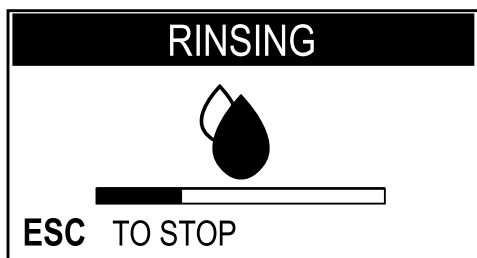

 The progress bar indicates that the machine is performing the rinse cycle of the system.

A small amount of water is dispensed. Wait until the cycle is completed.

 The cycle can be stopped by pressing the "ESC" button.



When the logo is displayed, the machine is ready for use.

 If the machine is used for the first time or after a long period of inactivity, contact the Service Provider to start it up.

9.3 Rinse/Self-Cleaning Cycle

This cycle allows the internal coffee circuits to be rinsed with fresh water. The cycle is carried out:

- At machine start-up (with cold boiler);
- After priming the circuit (with cold boiler);
- During the Stand-by preparation phase (if at least one coffee-based product has been brewed);
- When turning off the machine after pressing the "Stand-by" button (if at least a coffee product has been brewed).

A small amount of water will be dispensed to rinse and heat all the machine parts. This icon is displayed.

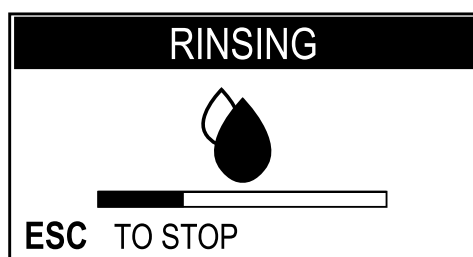

Wait for this cycle to be completed automatically. The dispensing process can be stopped by pressing the "ESC" button.

9.4 Eco-friendly: Stand-by

The machine is designed for energy saving. The machine will turn off automatically if it is not used for a set period of time after the last dispensing. This period of time is set by the service provider in the technical menu.

 During the turn-off phase, the machine will perform a rinse cycle if a coffee product has been brewed.

 Time can be programmed according to your needs (see instructions in chapter "Programming Menu").

Simply press a button on the control panel to restart the machine (if the power button is set to "I"). In this case the machine will go through the rinse cycle only if the boiler is cold.

9.5 Payment Systems

The coffee machine can be equipped with a payment system managed directly by the service provider. When the payment system is installed, beverage dispensing can be subject to payment.

When the machine is ready, the buttons for dispensing free beverages are lit, while the buttons for dispensing beverages upon payment are off.

If you want the beverage buttons to always be on, enable the option "Decount LED Beverage" in the "Payment System" section of the "Technical Menu".

Payment can be made either through the coiner or by magnetic card. Once the price has been paid, the button lights up and beverage dispensing is enabled.

This only applies if you use the coiner slot. It never happens with Apollo (unless DECOUNT LED BEVERAGE is enabled).

In any case, if a product requiring payment is selected before paying the full price, the following icon appears:

9.5.1 With Coiner

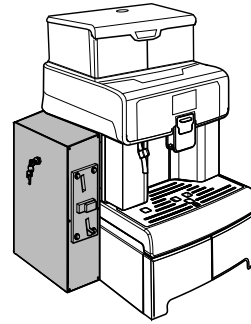

Before dispensing any beverage, insert coins until you meet the price set by the service provider.

 The service provider manages product prices and which coins may be used, and is to provide all appropriate information.

When the coiner is installed, the milk container must be placed on the right-hand side of the machine in order to improve machine operation.

All illustrations relating to the use of milk refer to the new machine layout. For further information, please refer to section "Installing the Cappuccinatore".

9.5.2 With Magnetic Card

 Danger of burning! The hot water wand may be hot.

Before dispensing any beverage, move the card close to the front panel of the machine (see figure).

The machine reads the credit in the card and enables beverage dispensing.

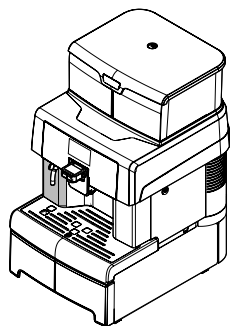

9.6 Types of LED light / machine operation

The machine is equipped with two types of LED light - blue and white - to illuminate the dispensing area. Their operation is explained below.

- Machine in warm-up phase: both blue and white LED lights continually fade on and off.
- Machine ready for use: only the blue LED lights are steady on.
- Machine dispensing coffee or mixed beverages: the blue LED lights are off and the white LED lights are steady on. When the beverage is ready, the white LED lights fade on and off for 4 seconds.
- Machine dispensing hot water: both the blue and white LED lights are off. Once the water has been dispensed, the LED lights are illuminated ready for use.

9.7 Brewing Coffee

To brew coffee, press:

- the "Espresso" button for an espresso;
- the "Espresso x2" button to brew two espressos;
- the "Coffee" button to brew a coffee;

Then the brewing cycle starts:

 To brew 2 coffees, the machine automatically grinds and doses the correct amount of coffee.

 Brewing two cups of coffee requires two grinding cycles and two brewing cycles, which the machine carries out automatically.

Once the prebrewing cycle has been completed, coffee begins to come out of the dispensing spout. Coffee brewing stops automatically when the preset level is reached. coffee dispensing can be stopped by pressing the selected product button again or the "ESC" button.

 The machine is adjusted to brew a true Italian espresso coffee. This feature may slightly lengthen the brewing time, allowing the intense coffee flavour to fully develop.

9.8 Cappuccinatore

This chapter explains how to use the milk Cappuccinatore to prepare a cappuccino, a Latte Macchiato or to froth milk.

 Before using the Cappuccinatore, clean it thoroughly as described in the "Cleaning and Maintenance" chapter.

 Use cold ($\sim 5^{\circ}\text{C}$ / 41°F) milk with a protein content of at least 3% to ensure top-quality beverages. Whole milk, skimmed milk, soy milk or lactose-free milk may be used depending on individual taste.

 Do not use any liquids other than cleaning water or milk.

9.8.1 Installing the Cappuccinatore

The Cappuccinatore must be suitably assembled based on whether the machine is equipped with a coiner.

9.8.1.1 Cappuccinatore without Coiner

The machine is normally installed without coiner. In this case, the left-hand fitting must be installed on the Cappuccinatore.

Insert the left-hand fitting in the Cappuccinatore.

 The lower part of the fitting is marked with the letter "L".

Insert the tube on the left-hand side of the fitting.

In this case, the suction tube can be attached to the holders as shown in the figure.

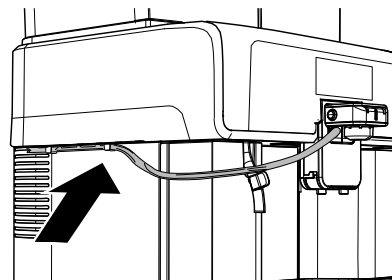

9.8.1.2 Cappuccinatore with Coiner

When the machine is equipped with a coiner, milk must be managed in a different way in order to be able to reach the coiner easily.

Insert the right-hand fitting in the Cappuccinatore.

 The lower part of the fitting is marked with the letter "R".

Insert the tube on the right-hand side of the fitting.

9.9 Brewing Cappuccino

The machine can dispense cappuccino quickly and easily with the touch of a button.

 Danger of burning! Dispensing may be preceded by small jets of hot water.

 Clean the Cappuccinatore immediately after using it to froth milk (see section "Cappuccinatore Cleaning (After Each Use)").

 Clean the suction hose externally with a damp cloth. This way, all parts will be perfectly clean and free of any milk residue.

Remove the cover from the front side.

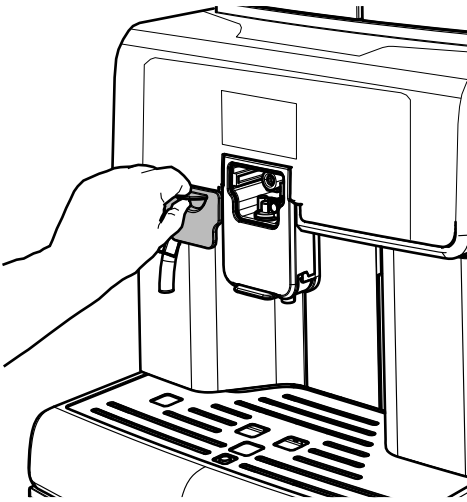

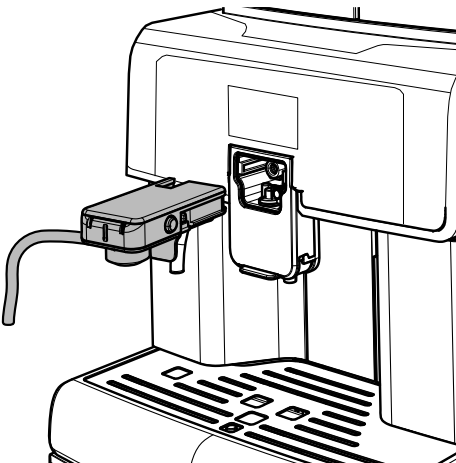

 The cover can be placed on the machine side using the integrated magnet.

Insert the Cappuccinatore into its seat until it locks into place. Check that it cannot be pulled out.



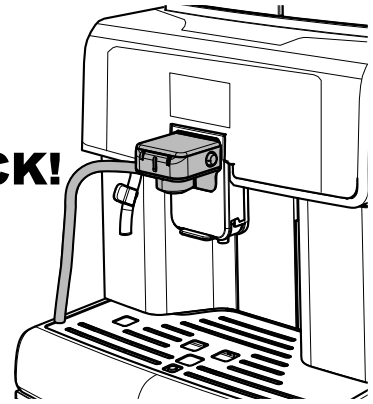

CLICK!

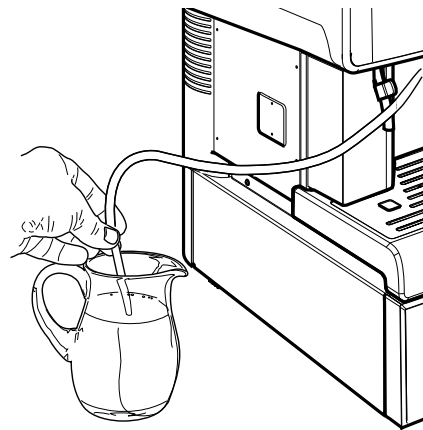

 Before using the Cappuccinatore, clean it as described in the "Cleaning the Cappuccinatore (After Each Use)" section.

Insert the clean tube directly into the milk container.



 To ensure better results when preparing a cappuccino, use cold milk.

Place the cup under the dispensing spout.



Press the "Cappuccino" button.
The machine needs time to preheat.

After preheating, the machine starts brewing cappuccino.



The machine dispenses frothed milk. Dispensing can be stopped by pressing the "Cappuccino" button or the "ESC" button.

Once milk has been brewed, the machine dispenses the coffee. Dispensing can be stopped by pressing the "Cappuccino" button or the "ESC" button.



Enjoy your cappuccino as if straight from the coffee shop.
After using the Cappuccinatore, clean it as described in the "Cleaning the Cappuccinatore (After Each Use)" section.

Remove the container and clean it if necessary.

 The machine can dispense both milk and coffee at the same time. This function must be activated by the service provider.

In this case, press the "Cappuccino" button to brew a cappuccino. The display shows:



The machine brews the cappuccino in one single step. In this case, by pressing the "Cappuccino" button or the "ESC" button, the entire beverage stops being dispensed.

 This function can be activated for all beverages for which both milk and coffee need to be dispensed.

 Setting ECOMODE to OFF brings down the dispensing time of mixed products.

9.10 Brewing Latte Macchiato

The machine can dispense Latte Macchiato quickly and easily with the touch of a button.

 **Danger of burning!**
Dispensing may be preceded by small jets of hot water.

 Clean the Cappuccinatore immediately after using it to froth milk (see section "Cappuccinatore Cleaning (After Each Use)").

 Clean the suction hose externally with a damp cloth. This way, all parts will be perfectly clean and free of any milk residue.

Remove the cover from the front side.

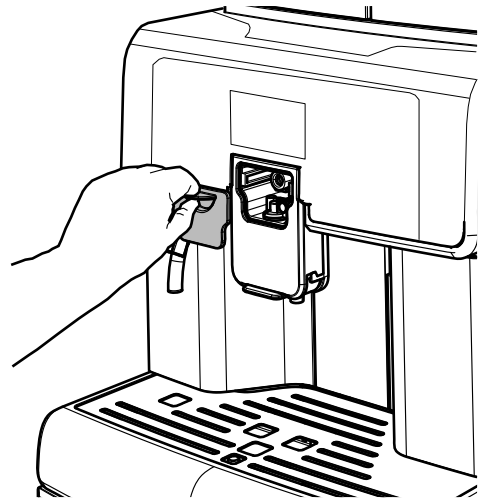

 The cover can be placed on the machine side using the integrated magnet.

Insert the Cappuccinatore into its seat until it locks into place. Check that it cannot be pulled out.

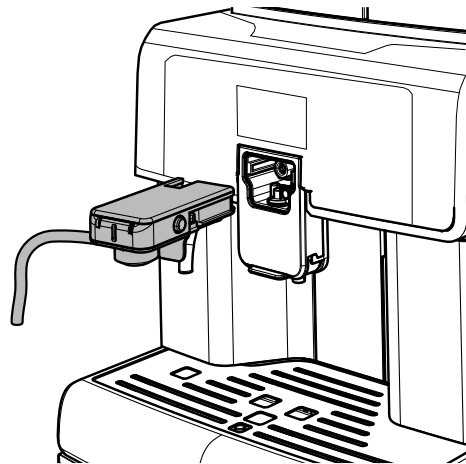

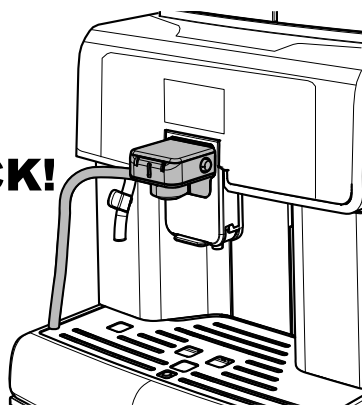
CLICK!

We recommend using tall glasses for this type of preparation, thus properly moving the coffee dispensing spout.



 Before using the Cappuccinatore, clean it as described in the "Cleaning the Cappuccinatore (After Each Use)" section.

When the machine is ready, press the "Latte Macchiato" button to start dispensing the Latte Macchiato. The machine prepares the Latte Macchiato automatically. After using the Cappuccinatore, clean it as described in the "Cleaning the Cappuccinatore (After Each Use)" section. Remove the container and clean it if necessary.

9.11 Dispensing Milk

Insert the clean tube directly into the milk container.

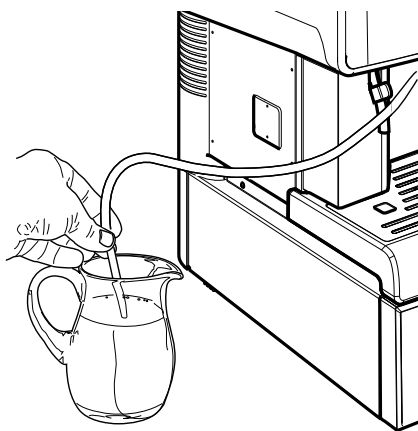

The machine can dispense Hot milk quickly and easily with the touch of a button.

 **Danger of burning!**
Dispensing may be preceded by small jets of hot water.

 Clean the Cappuccinatore immediately after using it to froth milk (see section "Cappuccinatore Cleaning (After Each Use)").

 To ensure better results when preparing a Latte Macchiato, use cold milk.

 Clean the suction hose externally with a damp cloth. This way, all parts will be perfectly clean and free of any milk residue.

Remove the cover from the front side.

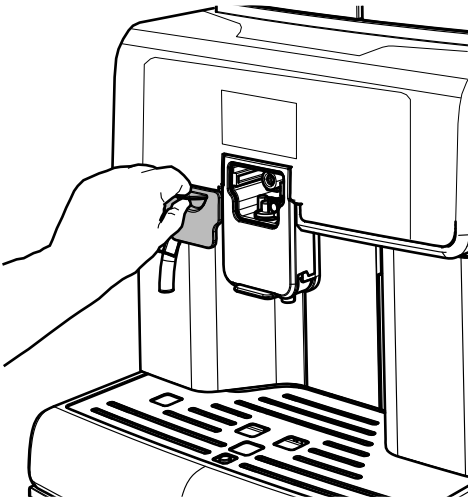

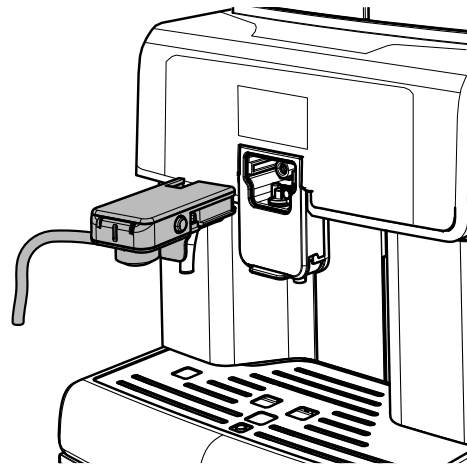

 The cover can be placed on the machine side using the integrated magnet.

Insert the Cappuccinatore into its seat until it locks into place. Check that it cannot be pulled out.



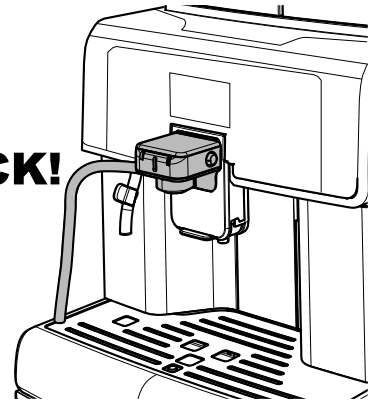

CLICK!

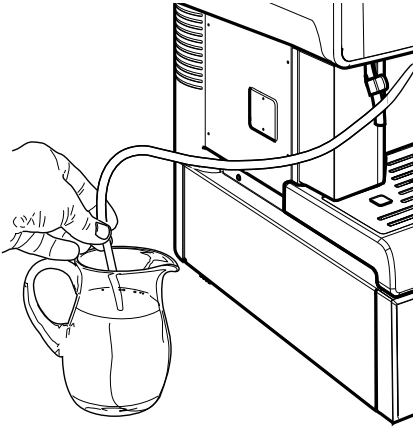

 Before using the Cappuccinatore, clean it as described in the "Cleaning the Cappuccinatore (After Each Use)" section.

Insert the clean tube directly into the milk container.



 To ensure better results when preparing milk, use cold milk.

We recommend using tall glasses for this type of preparation, thus properly moving the coffee dispensing spout.



When the machine is ready, press the "Milk" button to start dispensing the hot milk.

The machine prepares the hot milk automatically. After using the Cappuccinatore, clean it as described in the "Cleaning the Cappuccinatore (After Each Use)" section. Remove the container and clean it if necessary.

9.12 Hot Water Dispensing

 Danger of burning! Dispensing may be preceded by small jets of hot water. The hot water wand may reach high temperatures.

Place a container under the hot water wand.

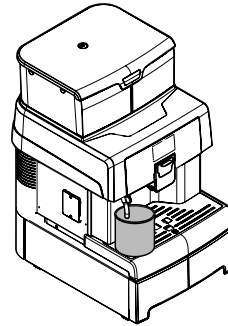

Press the "Hot water" button to start dispensing hot water from the wand.

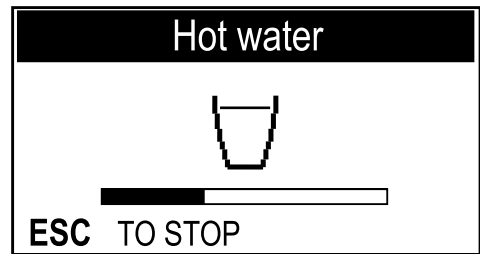

After dispensing, remove the container with hot water.

 Dispensing can be stopped by pressing the "Hot water" button or the "ESC" button.

9.13 "Extra" products

The machine is designed to also brew products other than those displayed on the control panel.

After pressing the "Extra" button, if no product is selected, the machine returns to the main menu after 10 seconds.

Press the "Extra" button to access the menu.



The "STEAM" function is visible and may only be selected if the service provider has enabled this option. Otherwise, it is not available.

The display shows the page for "Extra" beverages.

In this menu, you can just brew one product at a time. To brew more products, repeat the described procedures.

Select the desired beverage by pressing the "UP" button or "DOWN" button.

When the desired beverage has been selected, press the "OK" button to start the preparation.

Refer to the section describing the brewing procedure for the desired beverage.

In order to prepare milk-based beverages, install the Cappuccinatore after washing it as described in the "Cleaning the Cappuccinatore (After Each Use)" section.

Long Coffee

This programme allows you to prepare a long coffee. Press the "Extra" button to access the menu.

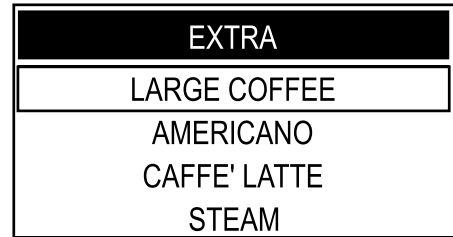

Place a suitable cup under the coffee dispensing spout.

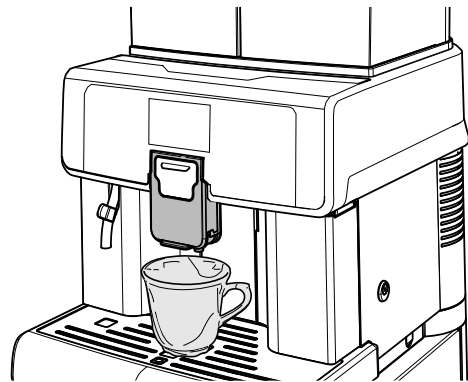

Press the "OK" button to start the preparation. After brewing, remove the cup of coffee.

 Dispensing can be stopped by pressing the "Extra" button or the "ESC" button.

American Coffee

This programme allows you to prepare an American coffee.

Press the "Extra" button to access the menu.

Press the "DOWN" button to select "AMERICAN COFFEE".

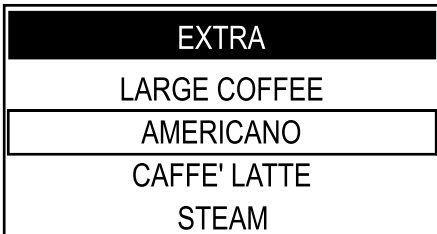

Place a suitable cup under the dispensing spout.

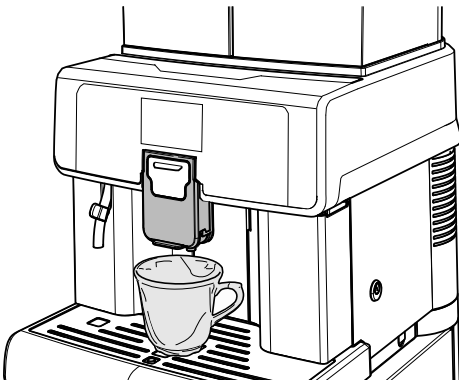

Confirm by pressing the "OK" button to start the preparation.

After brewing, remove the cup of coffee.

 Dispensing can be stopped by pressing the "Extra" button or the "ESC" button.

Caffè Latte

This programme allows you to prepare a coffee with hot milk.

 Danger of burning! Dispensing may be preceded by small jets of hot water.

Remove the cover from the front side.

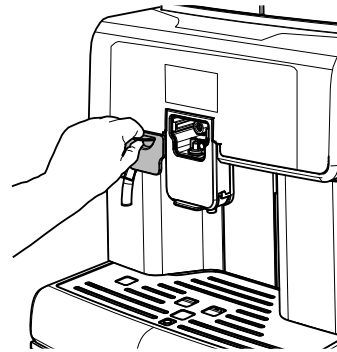

 The cover can be placed on the machine side using the integrated magnet.

Insert the Cappuccinatore into its seat until it locks into place. Check that it cannot be pulled out.

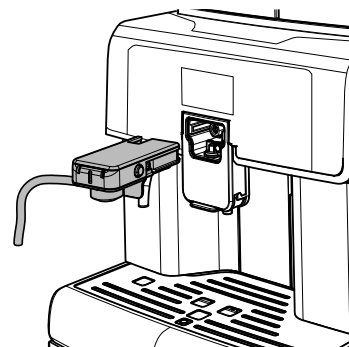

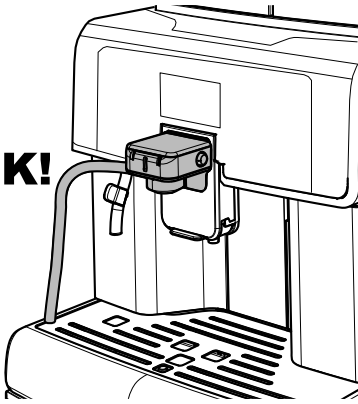
CLICK!

Press the "Extra" button to access the menu.
Press the "DOWN" button to select "CAFFE LATTE".

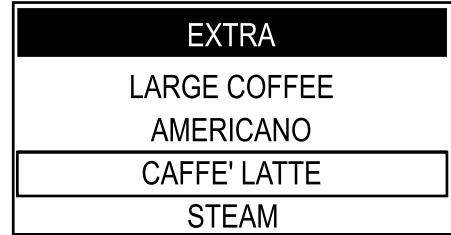

 Before using the Cappuccinatore, clean it as described in the "Cleaning the Cappuccinatore (After Each Use)" section.

Insert the clean tube directly into the milk container.

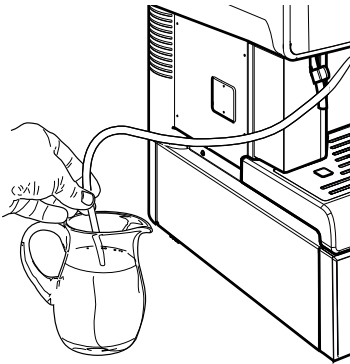

 To ensure better results when preparing a cappuccino, use cold milk.

Place a suitable cup under the dispensing spout.





Confirm by pressing the "OK" button to start the preparation.

 Brewing can be stopped by pressing the "Extra" button or the "ESC" button.

When dispensing has been completed, remove the cup of coffee and hot milk.

Steam

 This function is only available if previously activated by the service provider.

 Danger of burning! Dispensing may be preceded by small jets of hot water. The steam wand may reach high temperatures.

This program allows steam to be dispensed in order to heat the beverages directly in the container.

Press the "Extra" button to access the menu.
Press the "DOWN" button to select "STEAM".



Place a suitable container under the dispensing spout.

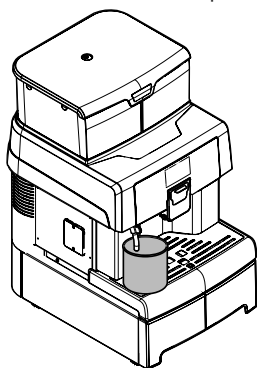

Press the "OK" button to confirm.
The machine warms up the system. Once the required temperature is reached, the steam dispensing procedure is started. To stop steam dispensing, press the "Extra" button or the "ESC" button.
Clean the steam wand with a wet cloth after use, if necessary.

9.14 Adjusting Brewed Products

The machine allows you to adjust the product length according to your needs and to the type of cup used.

The product length in the cup or glass can be set by two methods:

- CONFIG. BREWING MODE
- CONFIG. WITH PARAMETERS

9.14.1 CONFIG. BREWING MODE

This method allows the product length to be set by the service provider via keypad in visual mode. The product quantity is adjusted while being brewed.

Switch to machine programming mode as described in section "Access to the Technical Menu".

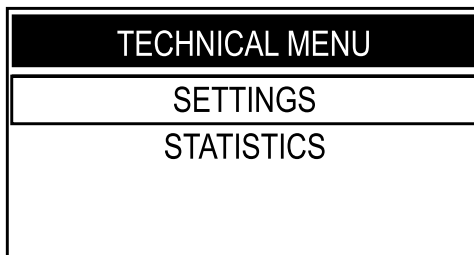

Select the "SETTINGS" option and press the "OK" button.

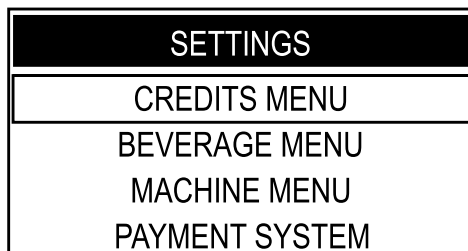

To select the "BEVERAGE MENU" option, press the "DOWN" button.

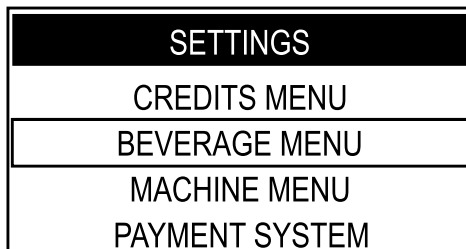

Press the "OK" button to enter.

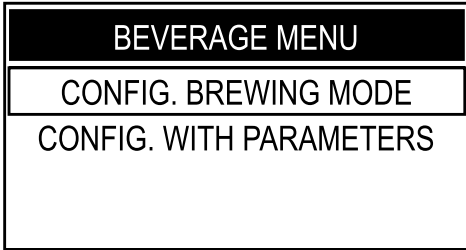

Press the "OK" button to access the CONFIG. BREWING MODE menu.



Select the beverage that you wish to program and stop the brewing process when desired, as shown on the display.

The procedure for programming a cappuccino is explained as an example. Before carrying out the programming procedure, prepare the machine as described in section "Brewing a Cappuccino".

Place a cup under the dispensing spout.



To select the "Cappuccino" option, press the "DOWN" button multiple times.



Press the "OK" button to enter. The machine is now in programming mode. The machine starts the milk dispensing phase. The "OK TO SAVE" message appears on the display.

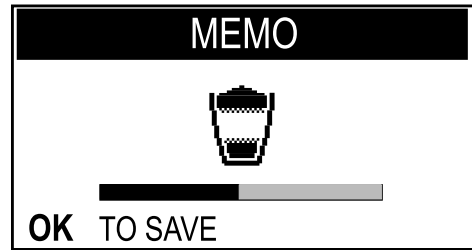

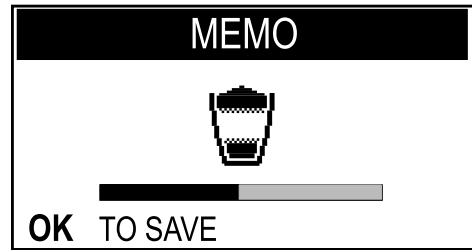

Press the "OK" button when the desired amount of milk is reached in the cup.

The machine immediately begins the coffee brewing phase. The "OK TO SAVE" message appears on the display.



Press the "OK" button when the desired amount of coffee is reached in the cup. Now the "Cappuccino" button is programmed. Each time it is pressed, the machine will brew the same amount that was just programmed.

 The length of all products, except for "AMERICAN COFFEE" and "STEAM", can be programmed by following the above procedure.

 The programming of the beverage ESPRESSO has an impact also on the beverage setting of ESPRESSO X2.

9.14.2 CONFIG. WITH PARAMETERS

To set the length with this method, enter the "BEVERAGE MENU" and program each available beverage using the keypad. This system requires the user to carry out a subsequent check of the actual quantity of product brewed in the cup.

The procedure for programming a cappuccino, with detailed operational sequences, is explained as an example.

Switch to machine programming mode as described in section "Access to the Technical Menu".

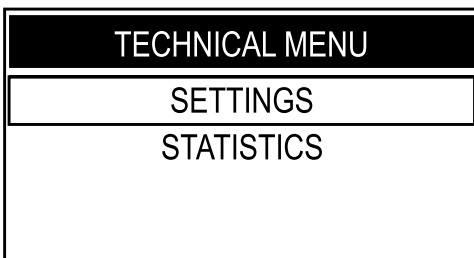

Select the "SETTINGS" option and press the "OK" button.

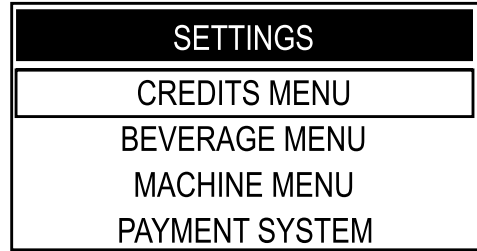

To select the "BEVERAGE MENU" option, press the "DOWN" button.

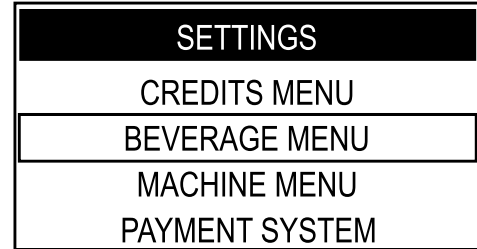

Press the "OK" button to enter.

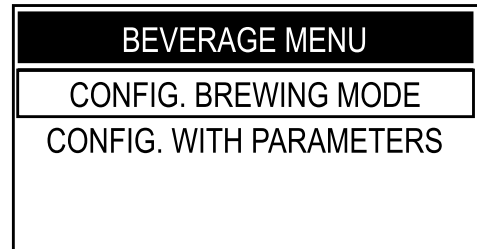

Press the "DOWN" button to select the "CONFIG. WITH PARAMETERS" option.

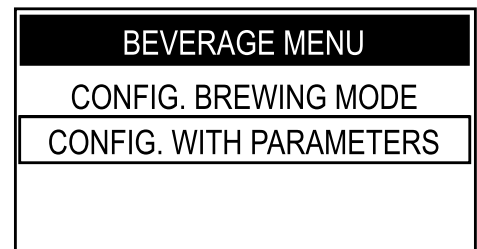

Press the "OK" button to enter.

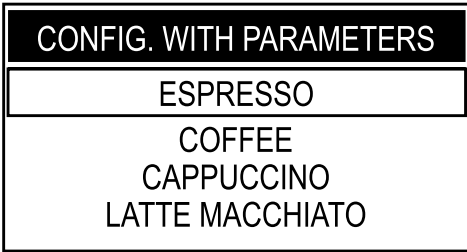

To select the "Cappuccino" option, press the "DOWN" button multiple times.

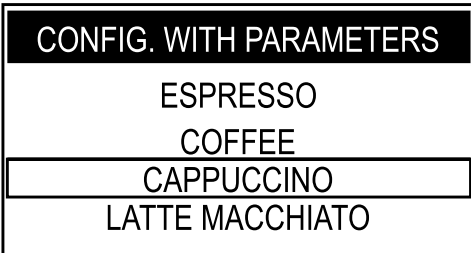

Press the "OK" button to enter.

Press the "DOWN" button to select the "COFFEE TEMPERATURE" menu.

Press the "OK" button to enter.

Press the "DOWN" button or the "UP" button to select the desired value. Then press the "OK" button to confirm and exit.

Press the "DOWN" button to select the "COFFEE LENGTH" menu.

Press the "OK" button to access the "PREBREWING" menu.

Press the "OK" button to enter.

Press the "DOWN" button or the "UP" button to select the desired value. Then press the "OK" button to confirm and exit.

Press the "DOWN" button or the "UP" button to move the bar and select the desired value; the number on the side identifies the bar value (in pulses). Then press the "OK" button to confirm and exit.

Press the "DOWN" button to select the "MILK QUANTITY" menu.



Press the "OK" button to enter.

Press the "DOWN" button or the "UP" button to move the bar and select the desired value; the number on the side identifies the bar value (in seconds). Then press the "OK" button to confirm and exit.

Press the "DOWN" button to select the "PAUSE" menu.



Press the "OK" button to enter.

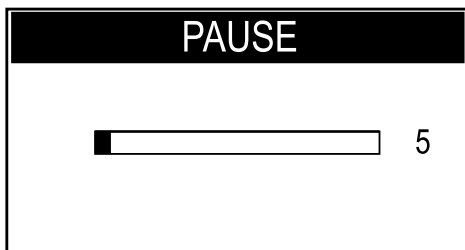

Press the "DOWN" button or the "UP" button to select the desired value.

Press the "DOWN" button to select the "HIGH SPEED MILK" menu.



Press the "OK" button to enter.

Press the "DOWN" button or the "UP" button to select the desired value.

 By activating this function, milk and coffee are dispensed at the same time.

Then press the "OK" button to confirm and exit.

When this phase has been completed, the beverage is programmed. It is recommended to perform a visual check of the result. To restore the factory settings of a single beverage, proceed as follows.

 The factory settings can be restored for each single beverage and the restored settings will be applied only to that specific beverage. To restore the other beverages' settings, enter the menu and restore the settings.

Press the "DOWN" button to select the "DEFAULT" menu.

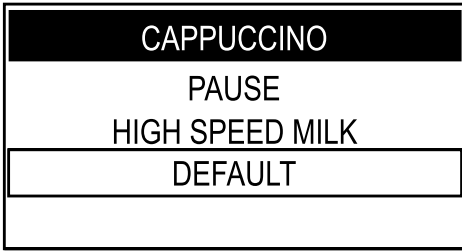

Press the "OK" button to enter.

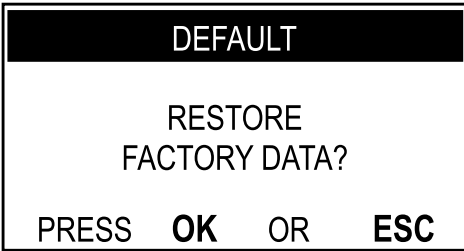

 The restoring operation permanently deletes the stored data. To exit the procedure, press the "ESC" button.

 Resetting the ESPRESSO beverage to factory settings will also reset the ESPRESSO X2 settings, apart from the price line.

Press the "OK" button to confirm. The beverage factory settings have been restored. Press the "ESC" button once or multiple times to exit.

9.15 Using the Machine with Credits

 This option can be enabled or disabled by the service provider.

The machine is designed to manage beverage brewing by means of a credit system. The number of coffee-based products brewed is limited to the number of credits granted by the service provider.

When no credits remain, no more coffee-based products can be brewed.

The available credit is displayed in the "ready for use" screen.

 Hot water, hot milk and steam dispensing is not subject to credit; it can always be performed, provided that there is water in the tank.

Each service provider decides independently how to manage the granting and recharging of credits to allow the machine to be used.

9.16 Emptying the Coffee Grounds Drawer

 This operation must be performed with the machine turned on and/or in stand-by mode.

The machine will indicate when the coffee grounds drawer has reached its maximum capacity.

The first warning alerts the user that the coffee grounds drawer must be emptied, but the machine can still be used to brew coffee.

The display will show:



If the drawer is not emptied after several brewing cycles, the machine will stop and the display will show:

may the coffee grounds drawer be inserted into the machine. Having inserted the drawer, the display will show:



The machine is now ready to brew coffee.

In this case, the machine does not allow beverages to be dispensed. In order to dispense beverages, the coffee grounds drawer must be emptied of used coffee.

Remove the coffee grounds drawer and empty out the coffee grounds in a suitable container.

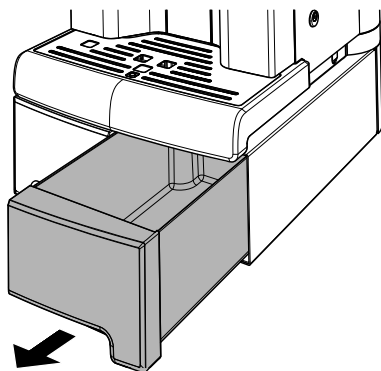

Only when the display shows:

10 CLEANING AND MAINTENANCE

 Before performing any maintenance and/or cleaning operation, unplug the power cord.

 The Manufacturer is not liable for damage or malfunctions caused by a wrong or lack of maintenance.

 Avoid using chlorine-based tablets so as to prevent oxidation phenomena inside the appliance.

10.1 General Notes for Correct Operation

 Non-removable components and the machine itself must be cleaned, when not differently specified, only by using cold or lukewarm water, with a non-abrasive sponge and a damp cloth.

 Never use direct jets of water onto the appliance and/or its components.

Periodic maintenance and cleaning will keep the machine in good working order for a longer time and ensure compliance with basic hygienic standards.

Follow the instructions and timing indicated in the "MAINTENANCE SCHEDULE" to ensure correct operation of the appliance.

10.2 Cleaning and Scheduled Maintenance

 All parts requiring cleaning are easily accessible, so no tools are needed.

 All parts must be washed with lukewarm water only and without using detergents or solvents that could change their shape or performance.

 All removable parts cannot be washed in the dishwasher.

 Do not clean the electric parts with wet cloths and/or with degreasing detergents. Remove any dust residues with a jet of dry compressed air or with an antistatic cloth.

10.2.1 Maintenance Schedule

Operation to be carried out	A	B	C	D
Drip tray	-	yes	-	-
Emptying and cleaning the coffee grounds drawer	yes	-	-	-
Thorough Cleaning of the Cappuccinatore	-	-	-	yes
Water tank cleaning	-	-	yes	-
Brew group cleaning	-	-	yes	-
Brew group lubrication	-	-	-	yes
Coffee bean hopper cleaning	-	-	-	yes
Descaling	yes	-	-	-

A When an alert is shown

B Daily

C Weekly

D Every month or 500 brewing cycles

 The machine and its parts should in any case be cleaned every week.

 The appliance and its parts should be cleaned and washed following a period of inactivity.

10.2.2 Cleaning the Hot Water/Steam Wand

The hot water/steam wand must be cleaned externally with a damp cloth after each use and, in any case, once a week.

 Before performing this operation, make sure that the wand is cold. Danger of Burning.

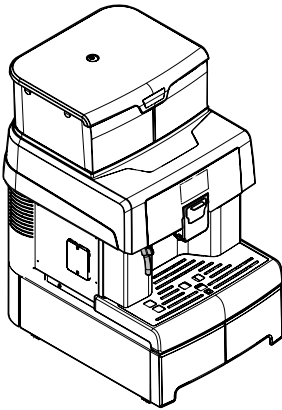

10.2.3 Cleaning the Coffee Grounds Drawer

The coffee grounds drawer is to be emptied and cleaned whenever indicated by the machine. To carry out this operation, refer to section "Emptying the Coffee Grounds Drawer".

10.2.4 Cleaning the Water Tank

The water tank should be cleaned every time it is filled.

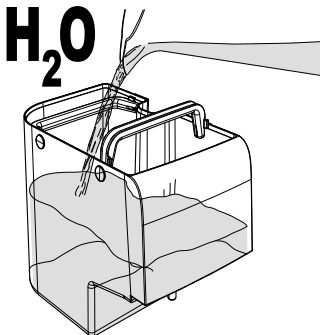

10.2.5 Cleaning the Drip Tray

Empty and wash the drip tray daily; this operation must also be performed when the float is raised.

Remove the drip tray.

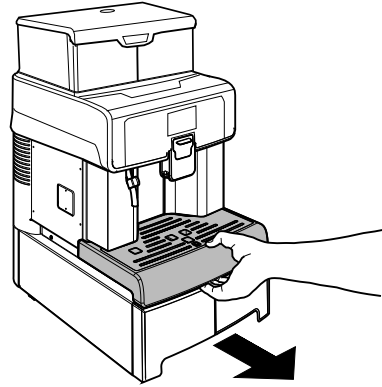

Empty the drip tray and wash it.

Reinsert the drip tray.

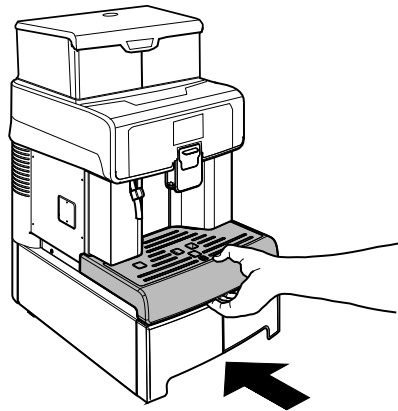

10.2.6 Cleaning the Cappuccinatore (After Each Use)

 Failure to clean the Cappuccinatore after use with milk may cause proliferation of bacteria which may be harmful for the user.

The Cappuccinatore must be washed and cleaned every time it is used. The lack of cleaning before and after each use can affect the correct operation of the machine.

 Danger of burning! Dispensing may be preceded by small jets of hot water.

Perform a quick cleaning procedure as follows:

Make sure that the Cappuccinatore complete with all its parts is correctly inserted.

Place a container under the dispensing spout.



The machine will ask to run the Cappuccinatore cleaning cycle after dispensing a milk-based beverage.

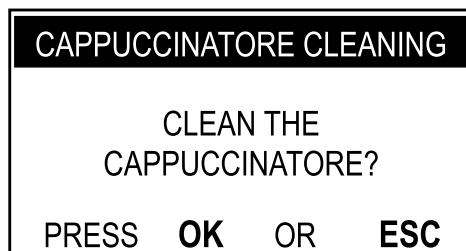

Press the OK button to start the cleaning cycle of the Cappuccinatore and place a container under the coffee dispensing spout. Follow the instructions on the display.

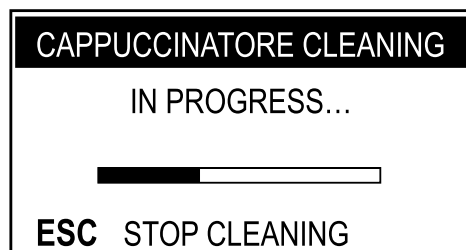

 Press the "ESC" button to exit the cycle at any time.

The machine performs a short wash cycle of the Cappuccinatore. Wait until the cycle has been completed.

 It is advisable to remove the Cappuccinatore from the machine when not being used, in order to keep it clean.

10.2.7 Thorough Cleaning of the Cappuccinatore

Clean all the Cappuccinatore parts thoroughly every month using the Saeco detergent. The Saeco detergent may be purchased at your local dealer or at authorised service centres.

The lack of cleaning before and after each use can affect the correct operation of the machine.

 **Danger of burning!**
Dispensing may be preceded by small jets of hot water.

Ensure that the Cappuccinatore is correctly positioned.

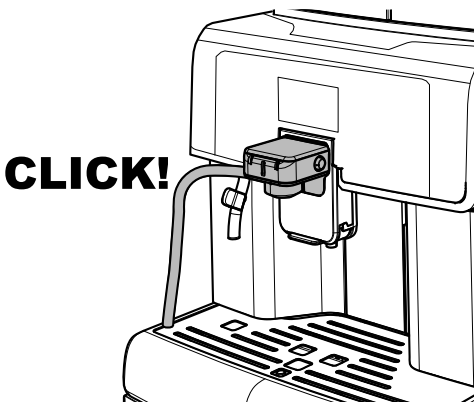
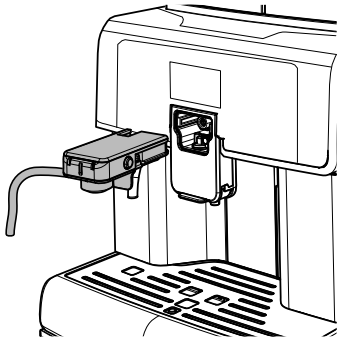

Access the user menu as described in the "Access to the User Menu" section.

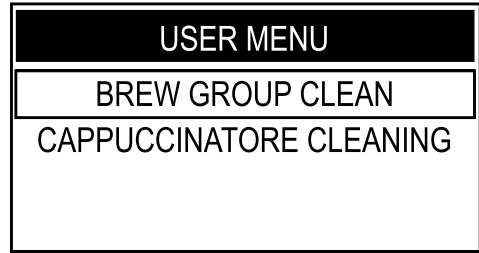

Press the "DOWN" button to select the "CAPPUCCINATORE CLEANING" option.

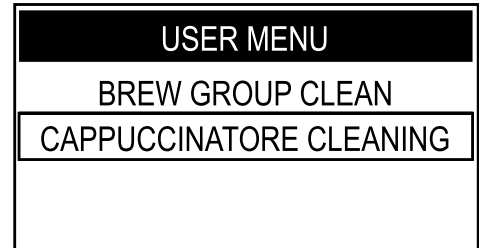

Press the "OK" button to access.

Press the "OK" button to access.

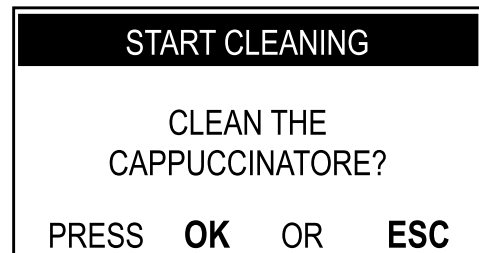

Press the "OK" button to start the Cappuccinatore cleaning cycle.

CAPPUCCINATORE CLEANING

REFILL WATER TANK
AND PRESS OK

ESC TO EXIT

Fill the water tank and press the "OK" button to confirm.

CAPPUCCINATORE CLEANING

POUR DETERGENT IN A
CONTAINER WITH 1/2 L
WATER AND PRESS OK

ESC TO EXIT

Pour a sachet of solution into a container with 1/2 (half) litre of fresh drinking water.

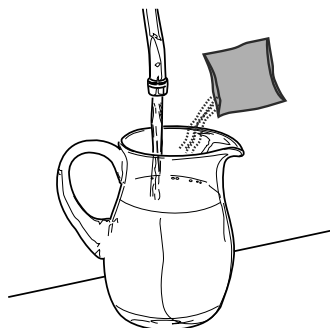

Wait for the bag content to dissolve completely and then press the "OK" button to confirm.

CAPPUCCINATORE CLEANING

PUT CAPPUCCINATORE
TUBE IN THE CONTAINER
AND PRESS OK

ESC TO EXIT

Insert the clean tube directly into the container.
Press the "OK" button to confirm.

 Do not drink the solution dispensed during this procedure. The solution must be disposed of.

CAPPUCCINATORE CLEANING

PLACE A CONTAINER
UNDER THE DISPENSING
SPOUT AND PRESS OK

ESC TO EXIT

 If this option is confirmed, the cycle must be completed. Press the "ESC" button to exit.

Place an empty container of at least 1 litre capacity under the dispensing spout and press the "OK" button to confirm. The machine performs a Cappuccinatore wash cycle.

CAPPUCCINATORE CLEANING

IN PROGRESS...

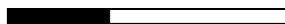

The bar shows the washing progress.
Wait until the cycle stops automatically. When the cycle has been completed, the display shows:

CAPPUCCINATORE RINSING

REFILL WATER TANK
AND PRESS OK

Rinse the water tank and fill it with fresh drinking water.
Press the "OK" button to confirm.

CAPPUCCINATORE RINSING

INSERT CAPPUCCINATORE
TUBE IN A CONTAINER WITH
1/2 L WATER AND PRESS OK

Wash the container used for the solution thoroughly and fill it with 1/2 (half) litre of fresh drinking water which will be used for rinsing.

Empty the container placed under the dispensing spout. Insert the suction hose into the container used. Press the "OK" button to confirm.

CAPPUCCINATORE RINSING

PLACE A CONTAINER
UNDER THE DISPENSING
SPOUT AND PRESS OK

Place an empty container under the dispensing spout and press the "OK" button to confirm.

CAPPUCCINATORE RINSING

IN PROGRESS...

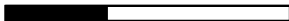

The machine performs a Cappuccinatore rinse cycle. The bar shows the rinsing progress.

Wait until the cycle stops automatically. The machine will go back to the normal operating cycle.

Wash all the Cappuccinatore parts as described in the "Cleaning the Cappuccinatore (After Each Use)" section.



It is advisable to remove the Cappuccinatore from the machine when not being used, in order to keep it clean.



Here is an explanation of how to disassemble and wash the Cappuccinatore with left-hand fitting. If the right-hand fitting is installed, you can carry out the same operations except that you will need to remove the suction tube and insert it on the opposite side to that shown here.

Remove the suction tube from the Cappuccinatore.

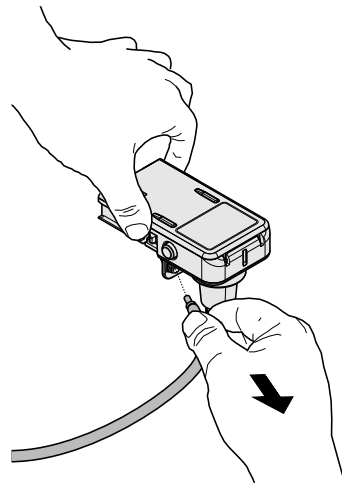

Remove the ring from the Cappuccinatore.

Wash the parts under running water. Make sure any milk deposits/residues are removed.

After washing, reassemble the parts following the same procedure used for disassembly, but in reverse order.

 After washing and reassembling the Cappuccinatore, it can be installed back in the machine. Use the hooks placed on the left side of the machine to attach the suction tube.

Turn and lift the Cappuccinatore cover and remove it from the Cappuccinatore body.

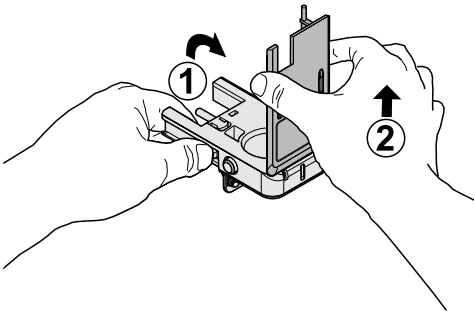

Remove the valve from the Cappuccinatore.

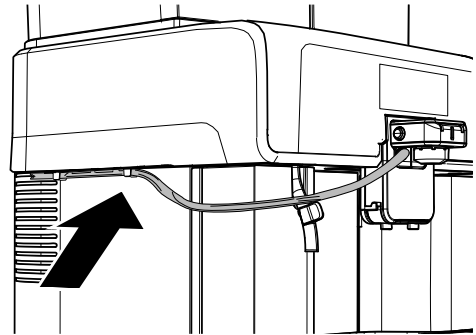
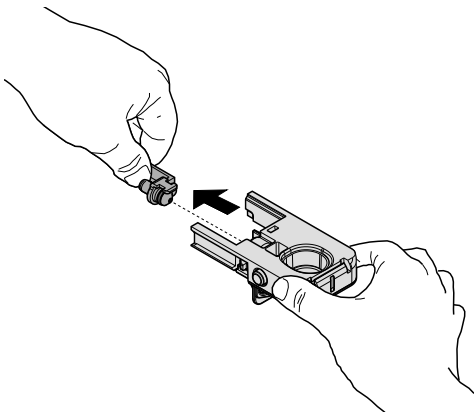

If the coiner is installed, fix the tube as shown in the figure by using the previously removed cover.

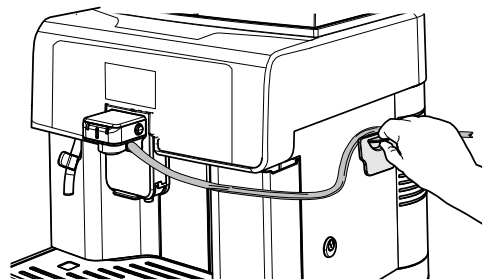

10.2.8 Brew Group Cleaning

The brew group should be cleaned whenever the coffee bean hopper is filled, or at least once a week. Turn off the machine by switching the power button to the "O" position and remove the plug from the socket. Open the service door with the supplied key.

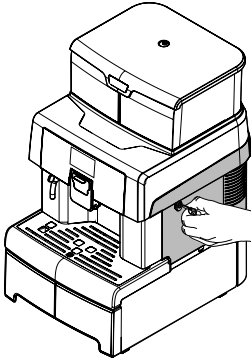

Remove the brew group by pulling it by the handle and pressing the «PRESS» button. The brew group must be washed with lukewarm water only. Do not use any detergent.

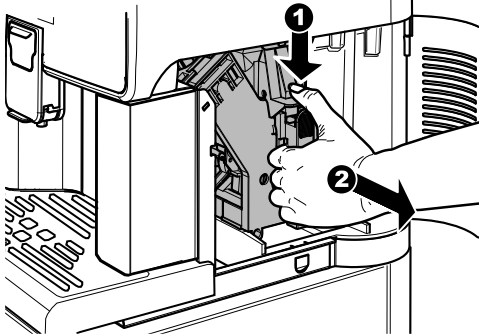

Wash the brew group with lukewarm water; carefully wash the upper filter. Before placing the brew group in its seat, ensure that there is no water left in the brewing chamber.

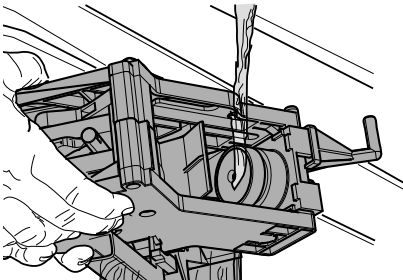

Lift the rear side of the inner drawer to unlock it.

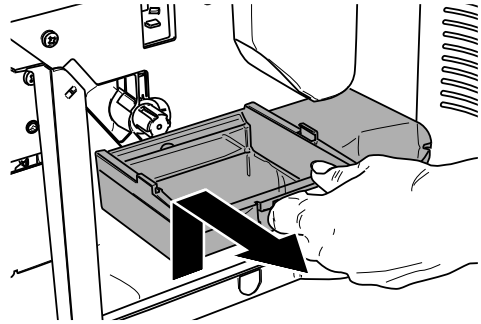

Take out the inner drawer, wash it and place it back in its seat.

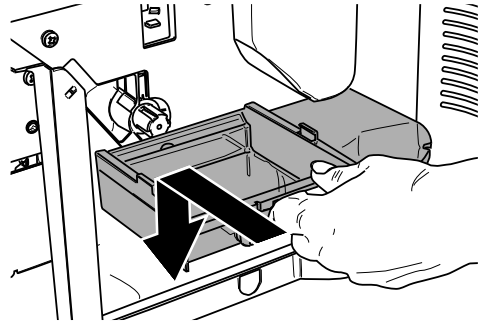

 When fitting the drawer, carry out the same operations performed for its removal, but in reverse order.

Make sure that the brew group is in the off position. The two reference marks must match.

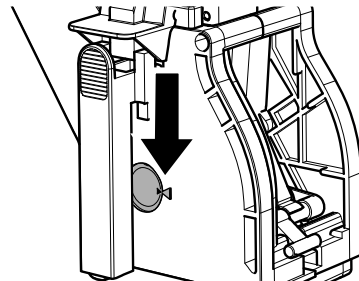

If they do not match, proceed as described below:

Ensure that the lever is in contact with the brew group base.

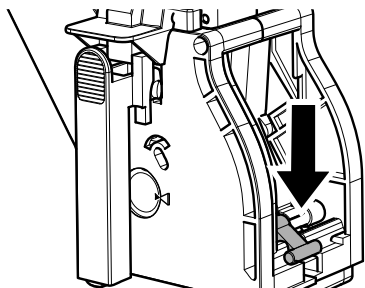

Make sure that the hook which locks the brew group is in the correct position. firmly press the "PRESS" button to check its position.

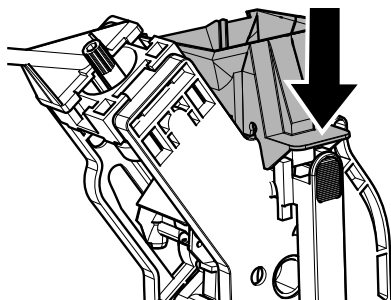

Insert the brew group into its seat again until it locks into place **WITHOUT** pressing the "PRESS" button.

Close the service door.

 Ensure that the brew group is completely dry before putting it back into the machine.

10.2.9 Brew Group Cleaning with the "Coffee Oil Remover"

Besides weekly cleaning, we recommend performing a cleaning cycle with "Coffee Oil Remover" after approximately 500 cups of coffee or once a month.

This operation completes the maintenance process for the brew group.

Both the "Coffee Oil Remover" system used to clean the brew group and the "Maintenance Kit" may be purchased at your local dealer or at authorised service centres.

 The "Coffee Oil Remover" system has no descaling properties. For descaling, use the Saeco descaling solution and follow the procedure described in the "Descaling" chapter.

The wash cycle cannot be interrupted. Do not leave the machine unattended during this operation.

 Do not drink the solution dispensed during this procedure. The solution must be disposed of.

Access the user menu as described in the "Access to the User Menu" section.

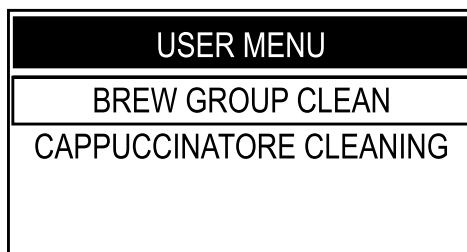

Press the "OK" button to access the brew group cleaning cycle.

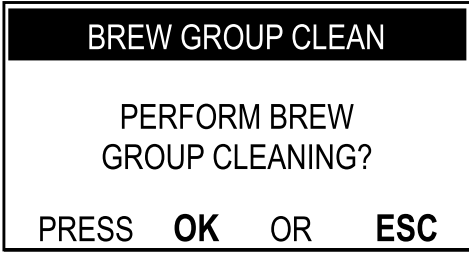

Press the "OK" button to access.

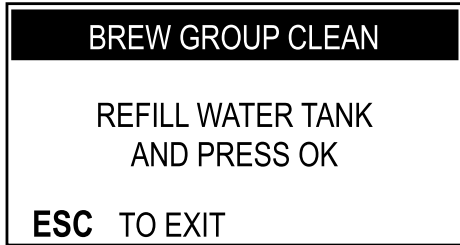

Press the "OK" button to start the brew group cleaning cycle.

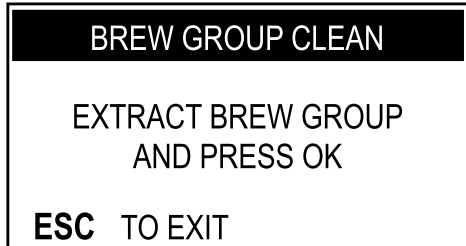

Open the service door with the supplied key.

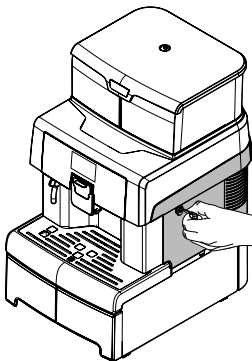

Remove the brew group by pulling it by the handle and pressing the «PRESS» button.

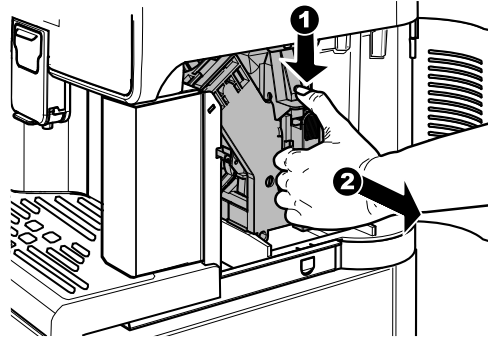

Press the "OK" button to confirm the removal of the brew group.

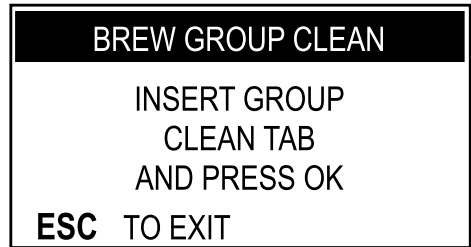

 If this option is confirmed, the cycle must be completed. Press the "ESC" button to exit.

Place the cleaning tablet in the brew group and refit the group in the machine, making sure that all the components have been inserted and that the door is closed.

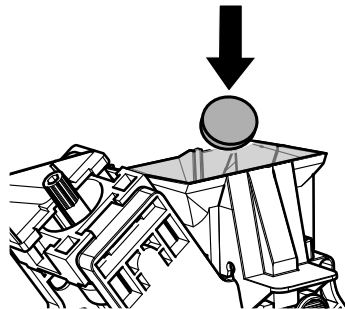

Apply the grease evenly on both side guides.

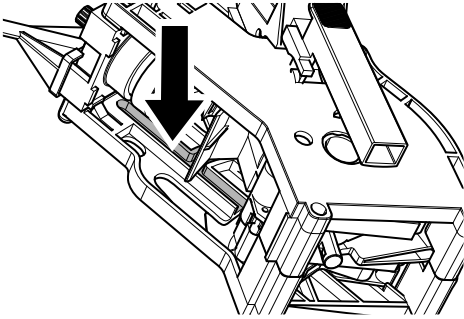

Lubricate the shaft too.

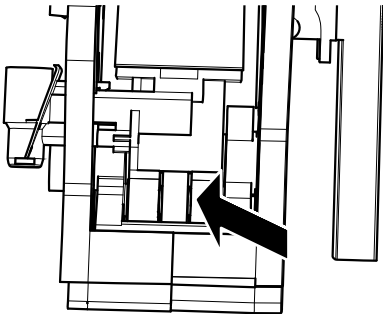
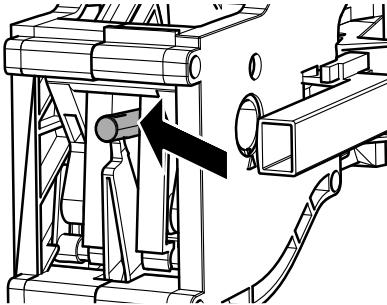

Insert the brew group into its seat again until it locks into place **WITHOUT** pressing the "PRESS" button.

Insert the coffee grounds drawer and the drip tray. Close the service door.

10.2.11 Descaling

Limescale is a natural part of the water used for machine operation. It needs to be removed regularly as it may clog the water and coffee circuit of your appliance.

The advanced electronics shows on the machine display (with clear icons) when descaling is needed. Just follow the steps described below.

This operation needs to be carried out before the appliance stops working properly, as in this case repair is not covered by warranty.

Use the Saeco descaling product only. Its formula has been specifically designed to ensure better machine performance and operation for its whole operating life. If correctly used, it also avoids alterations in the dispensed product.

The descaling solution and the complete "Maintenance Kit" may be purchased at your local dealer or at authorised service centres.

⚠ Never drink the descaling solution.

⚠ Never use vinegar as a descaling solution.

Turn on the machine by pressing the ON/OFF button. Wait for the machine to complete the rinse and warm-up process.

⚠ Remove the "Intenza" filter before adding the descaling solution.

Switch to machine programming mode as described in section "Access to the Technical Menu".

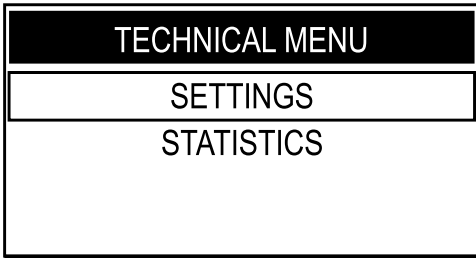

Select the "SETTINGS" option and press the "OK" button.

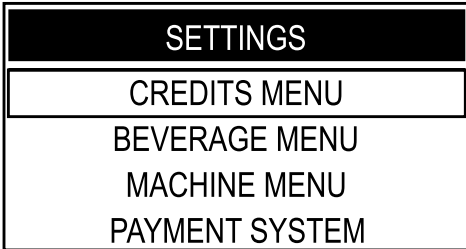

To select the "MACHINE MENU" option, press the "DOWN" button.

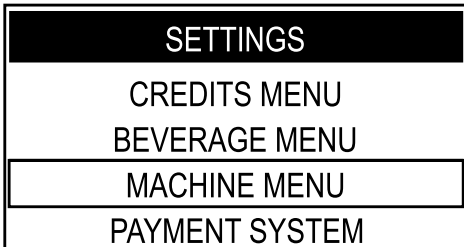

Press the "OK" button to enter.

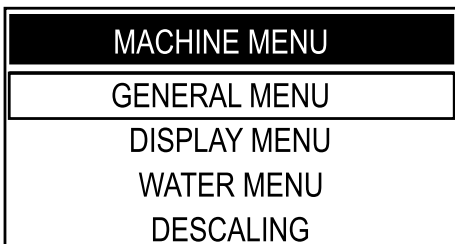

Press the "DOWN" button until the "DESCALING" option is selected.

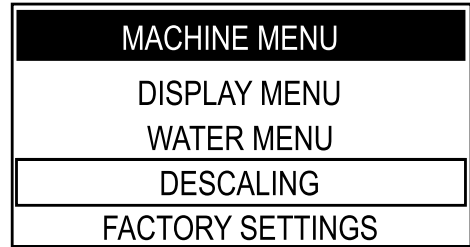

Press the "OK" button to enter.

Select the "START DESCALE" option; Press the "OK" button to continue.

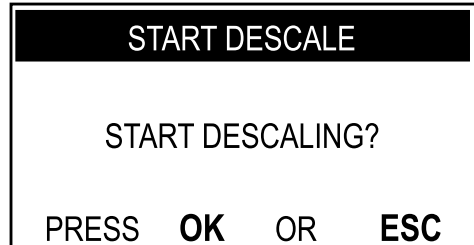

Press the "OK" button to start the DESCALING cycle.

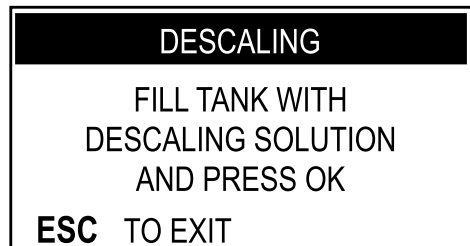

Fill the tank with water and descaling solution to the CALC CLEAN level marked on the back of the tank.

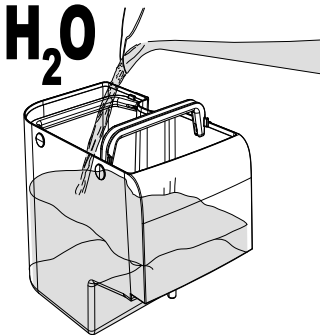
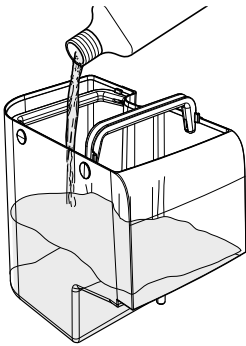

Put the water tank back into the machine. Press the "OK" button.

Remove the coffee dispensing spout.

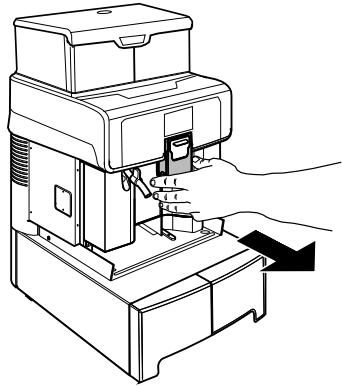

Press the "OK" button.



Insert the complete Cappuccinatore in the machine.



Drain any liquids from the drip tray and place it back into the machine.

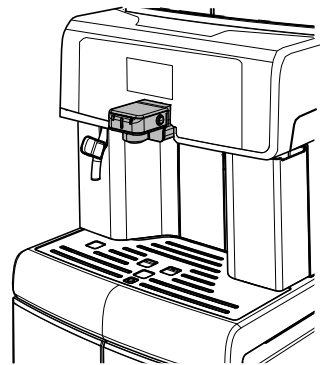

Press the "Coffee" button.

 Remove the suction tube from the Cappuccinatore while the descaling cycle is performed.

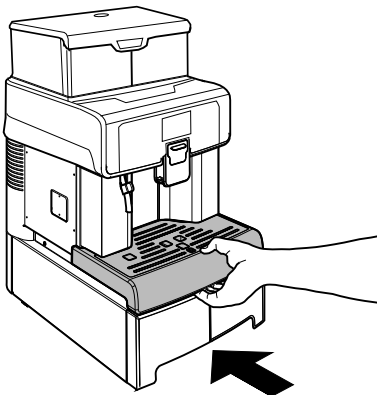

DESCALING

PLACE A CONTAINER UNDER
MILK AND HOT WATER SPOUTS
AND PRESS OK

ESC TO EXIT

DESCALING

STEP 1/2

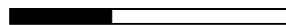

ON/OFF TO ABORT

DESCALING

STEP 1/2

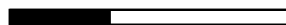

ESC TO PAUSE

 The descaling cycle will begin once this option is confirmed. Press the "ESC" button to pause the cycle. Press the "Stand-by" button to permanently cancel the cycle.

Place a container under the hot water wand and a large container under the Cappuccinatore.

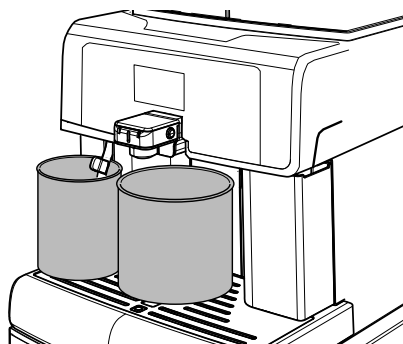

 Use a container of at least 1.5 litre capacity.

Press the "OK" button.

 If you do not have a container of this capacity, pause the cycle by pressing the "ESC" button, empty the container, put it back onto the machine and restart the cycle by pressing the "OK" button.

The machine will now start dispensing the descaling solution at intervals (the bar shows the cycle progress).

When the solution in the tank is finished, the machine requests to empty and rinse the tank with fresh drinking water.

DESCALING

RINSE TANK &
FILL WITH FRESH WATER
AND PRESS OK

Rinse the water tank thoroughly and fill it with fresh drinking water up to the MAX level marked on the back of the tank.

Insert the tank into the machine. Press the "OK" button.

Empty the containers used to collect the liquid dispensed by the machine.



Drain any liquids from the drip tray and place it back into the machine. Press the "OK" button.



Check that the Cappuccinatore is placed in the machine. Press the "OK" button.

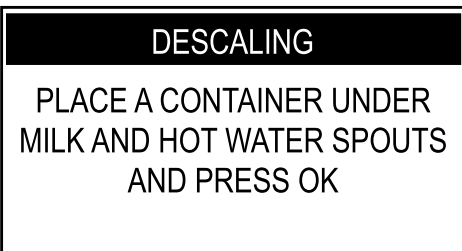

Place a container under the hot water wand and a large container under the Cappuccinatore. Press the "OK" button.

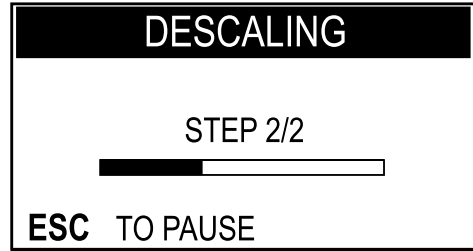
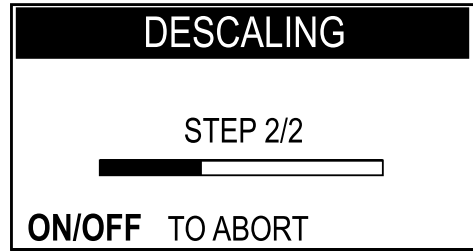



The machine performs the rinse cycle.

 A default amount of water is needed for the rinse phase. This allows an ideal rinse cycle to be performed in order to ensure the best conditions to brew products. A message to fill the water tank will be displayed throughout the rinse cycle. This is normal and part of the procedure.

 The rinse cycle may be paused by pressing the "ESC" button; to resume the cycle, press the "OK" button. This allows you to empty the container or to leave the machine unattended for a short time.

Once the rinse cycle has been completed, the machine carries out the circuit priming, the warm-up and rinse cycle in order to be ready for product brewing.

 The descaling solution is to be disposed of according to the manufacturer's instructions and/or the regulations in force in the country of use.

 After completing the descaling cycle, wash the brew group as described in the "Brew Group Cleaning" section in the "Cleaning and Maintenance" chapter.

 After completing the descaling cycle, rinse the Cappuccinatore under running water.

Empty the containers used to collect the liquid dispensed by the machine and reassemble the coffee dispensing spout.

The machine is now ready for use.

When the descaling cycle has been completed, it is recommended to empty the drip tray.







II TROUBLESHOOTING

II.1 Warning signals

This chapter describes all the warning messages that the machine may display to the user and the actions that can and/or must be performed by the user.

Warning Signals	How to reset the message
	To restore machine operation, close the service door.
	Insert the drip tray in its housing.
	Insert the coffee grounds drawer in its seat.
	Remove the tank and fill it with fresh drinking water.
	Insert the brew group into its seat.
	The selected operation requires milk dispensing. Insert the Cappuccinatore in the machine as specified in the manual.
	The selected operation requires milk dispensing. Insert the previously removed valve in the Cappuccinatore as described in the manual.
	Fill the coffee bean hopper with coffee beans and select one product.

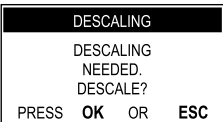

Warning Signals	How to reset the message
	<p>The machine requires a descaling cycle. When this message is displayed, it is still possible to use the machine, but its correct operation might be affected. Damage caused by failure to descale the machine is not covered by warranty.</p>
	<p>The machine indicates that the "Intenza" water filter should be replaced with a new one. Contact the service provider.</p>
	<p>The machine indicates that after a few cycles it will be necessary to empty the coffee grounds drawer (see section "Emptying the Coffee Grounds Drawer"). This message does not prevent the machine from brewing further products.</p>
	<p>Flashing red LED light. Machine in Stand-by. The Stand-by settings can be changed (contact the service provider). Press the "Stand-by" button.</p>
	<p>An event has occurred which requires the machine to be restarted. Take note of the code (E xx) shown at the bottom. Turn off the machine, wait for 30 seconds and then turn it on again. If the problem persists, contact the service centre.</p>
	<p>If this screen is displayed after starting the machine, a descaling cycle should be run. Contact the service provider. Please note that damage caused by failure to descale the machine is not covered by warranty.</p>
	<p>The water network connection icon indicates the correct machine setting for water network usage, where required. After installing and activating the water network operation mode, the machine works normally; the water tank is not to be filled again.</p>

11.2 Problems - Causes - Solutions

The following table indicates the possible error or alarm causes which may lead to a partial or total shutdown of the appliance.

Problems	Causes	Solutions
The machine does not turn on.	The machine is not connected to the electric network The ON/OFF button is on "0".	Connect the machine to the electric network. Switch the ON/OFF button to "I".
Coffee is not hot enough.	The cups are cold. The menu item relative to the coffee temperature is set to an insufficient value.	Preheat the cups with hot water. Contact the manager or the specialized technician. It is possible to adjust the coffee temperature via Menu.
Coffee does not have enough crema (see note).	The blend is unsuitable, coffee is not freshly roasted or the grind is too coarse.	Change coffee blend or adjust the grind setting as explained in the "Coffee Grind Adjustment" chapter.
The machine takes a long time to warm up or the amount of water dispensed is too little. Bubbles form at the Cappuccinatore spout while dispensing milk.	The machine circuit is clogged by limescale. The tube fittings are not connected properly or are not completely inserted into the Cappuccinatore.	Descalcify the machine. Insert the whole suction tube into the Cappuccinatore.
Steam comes out of the Cappuccinatore when sucking milk.	There is no more milk in the container.	Check that there is still milk. If necessary, fill in the milk container again or replace it with a new one.
The brew group cannot be removed.	The brew group is out of place.	Turn on the machine. Close the service door. The brew group automatically returns to the initial position.
The machine grinds the coffee beans but no coffee is brewed (see note).	The brew group is dirty.	Clean the brew group (see the "Brew Group Cleaning" chapter).
The coffee is too weak (see note).	The dispensing spout is dirty. Dose is too low.	Clean the dispensing spout. Adjust the amount of coffee to be ground.
Coffee is brewed slowly (see note).	The coffee grind is too fine.	Change coffee blend or adjust the grind as explained in the "Coffee Grind Adjustment" chapter.
Coffee leaks out of the dispensing spout.	The brew group is dirty.	Clean the brew group (see the "Brew Group Cleaning" chapter).
	The dispensing spout is clogged. The dispensing spout is not correctly positioned.	Clean the dispensing spout and its holes. Position the dispensing spout correctly.



These problems can be considered normal if the coffee blend has been changed or if the machine has just been installed.



Please contact our consumer care help line for any problems not covered in the table or when the suggested solutions do not solve the problem.

12 STORAGE - DISPOSAL

12.1 Location Change

Should the machine be placed in a different location, it is necessary to:

- disconnect the appliance from the supply network;
- carry out the general cleaning of the appliance as indicated in chapter "Cleaning and Maintenance";
- put the parts back into place and close the doors;
- Lift and position the appliance in the assigned location.

12.2 Inactivity and Storage

If the appliance needs to be stored or remains inactive for a long period, carry out the same operations as described in section "Location Change", therefore:

- wrap the appliance with a cloth to protect it from dust and humidity;
- make sure that the appliance is installed in a suitable place (temperature must be lower than 1°C) and be careful not to put cartons or appliances on it.

13

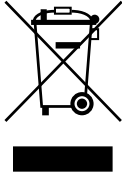
**INSTRUCTIONS FOR END OF OPERATIONAL LIFE
DISPOSAL****INFORMATION FOR THE USER**

in compliance with art. 13 of the Italian Legislative Decree dated 25 July 2005, no. 151 "Implementation of the directives 2002/95/EC, 2002/96/EC and 2003/108/EC on the restriction of the use of certain hazardous substances in electrical and electronic equipment, as well as waste disposal".

The crossed-out wheeled bin icon on the appliance or its packaging indicates that the product must be disposed of separately from other waste at the end of its operational life.

Separate collection of the appliance, once at the end of its operational life, is organised and managed by the manufacturer. Therefore, for an appropriate disposal, the user must contact the manufacturer and observe its separate collection management adopted for this appliance at the end of its operational life.

Separating this product for subsequent recycling, treatment and environmentally-friendly disposal will help prevent potential environmental and health risks, and allow the materials which make up the appliance to be re-used and/or recycled.

Specific administrative sanctions provided for by current regulations will be applied for illicit disposal of the product by the user.

