

- Please carefully read the operation instructions before powering on, and keep them safe.
- Product specifications subject to change without notice.



The Creative Life

Refrigerator  
Operating Instructions

**F42SDW**

## **Safety information**

---

In the interest of your safety and to ensure the correct use, before installing and first using the appliance, read this user manual carefully, including its hints and warnings. To avoid unnecessary mistakes and accidents, it is important to ensure that all people using the appliance are thoroughly familiar with its operation and safety features. Save these instructions and make sure that they remain with the appliance if it is moved or sold, so that everyone using it through its life will be properly informed on appliance use and safety.

For the safety of life and property keep the precautions of these user's instructions as the manufacturer is not responsible for damages caused by omission.

This appliance is not intended for use by persons (including children) with reduced physical, sensory or mental capabilities, or lack of experience and knowledge, unless they have been given supervision or instruction concerning use of the appliance by a person responsible for their safety.

Children should be supervised to ensure they do not play with the appliance.

### **General safety**

 **WARNING!** Keep ventilation openings, in the appliance enclosure or in the built-in structure, clear of obstruction.

 **WARNING!** Do not use mechanical devices or other means to accelerate the defrosting process, other than those recommended by the manufacturer.

 **WARNING!** Do not damage the refrigerant circuit.

## Safety information

---

 **WARNING!** Do not use electrical appliances inside the food storage compartments of the appliance, unless they are of the type recommended by the manufacturer.

Do not store explosive substances such as aerosol cans with a flammable propellant in this appliance.

The refrigerant isobutane (R600a) is contained within the refrigerant circuit of the appliance, a natural gas with a high level of environmental compatibility, which is nevertheless flammable.

During transportation and installation of the appliance, be certain that none of the components of the refrigerant circuit become damaged.

- avoid open flames and sources of ignition

- thoroughly ventilate the room in which the appliance is situated

It is dangerous to alter the specifications or modify this product in any way. Any damage to the cord may cause a short circuit, fire and/or electric shock.

This appliance is intended to be used in household and similar applications such as

- staff kitchen areas in shops, offices and other working environments;

- farm houses and by clients in hotels, motels and other residential type environments;

- bed and breakfast type environments;

- catering and similar non-retail applications.

 **WARNING!** Any electrical components (plug, power cord, compressor and etc.) must be replaced by a certified service agent or qualified service personnel.

Power cord must not be lengthened.

Make sure that the power plug is not squashed or damaged by the back of the appliance. A squashed or damaged power plug may overheat and cause a fire.

If the supply cord is damaged, it must be replaced by the manufacturer, its service agent or similarly qualified persons in order to avoid a hazard.

 **WARNING!** Do not locate multiple portable socket-outlet or portable power supplies at the rear of the appliance.

Make sure that you can come to the mains plug of the appliance.

Do not pull the mains cable.

If the power plug socket is loose, do not insert the power plug. There is a risk of electric shock or fire.

This appliance is heavy. Care should be taken when moving it.

Do not remove nor touch items from the freezer compartment if your hands are damp/wet, as this could cause skin abrasions or frost/freezer burns.

Avoid prolonged exposure of the appliance to direct sunlight.

## Safety information

---

### Daily use

Do not put hot on the plastic parts in the appliance.

Frozen food must not be re-frozen once it has been thawed out.

Store pre-packed frozen food in accordance with the frozen food manufacturer's instructions.

Appliance's manufacturer's storage recommendations should be strictly adhered to. Refer to relevant instructions.

Do not place carbonated or fizzy drinks in the freezer compartment as it creates pressure on the container, which may cause it to explode, resulting in damage to the appliance.

Ice lollies can cause frost burns if consumed straight from the appliance.

### Care and cleaning

Before maintenance, switch off the appliance and disconnect the mains plug from the mains socket.

Do not clean the appliance with metal objects.

Do not use sharp objects to remove frost from the appliance. Use a plastic scraper.

Regularly examine the drain in the chest freezer for defrosted water. If necessary, clean the drain.

### Installation

**Important!** For electrical connection carefully follow the instructions given in specific paragraphs.

Unpack the appliance and check if there are damages on it. Do not connect the appliance if it is damaged. Report possible damages immediately to the place you bought it. In that case retain packing.

It is advisable to wait at least four hours before connecting the appliance to allow the oil to flow back in the compressor.

Adequate air circulation should be around the appliance, lacking this leads to overheating. To achieve sufficient ventilation follow the instructions relevant to installation.

Wherever possible the spacers of the product should be against a wall to avoid touching or catching warm parts (compressor, condenser) to prevent possible burn.

The appliance must not be located close to radiators or cookers.

Make sure that the mains plug is accessible after the installation of the appliance.

## Safety information

---



### Service

Any electrical work required to do the servicing of the appliance should be carried out by a qualified electrician or competent person. This product must be serviced by an authorized Service Center, and only genuine spare parts must be used.

### Energy saving

- Don't put hot food in the appliance;
- Don't pack food close together as this prevents air circulating;
- Make sure food don't touch the back of the compartment(s);
- If electricity goes off, don't open the door(s);
- Don't open the door(s) frequently;
- Don't keep the door(s) open for too long time;
- Don't set the thermostat on exceeding cold temperatures;
- Some accessories, such as drawers, can be removed to get larger storage volume and lower energy consumption.

### Environment Protection

 This appliance does not contain gasses which could damage the ozone layer, in either its refrigerant circuit or insulation materials. The appliance shall not be discarded together with the urban refuse and rubbish. The insulation foam contains flammable gases: the appliance shall be disposed according to the appliance regulations to obtain from your local authorities. Avoid damaging the cooling unit, especially the heat exchanger. The materials used on this appliance marked by the symbol  are recyclable.

The symbol  on the product or on its packaging indicates that this product may not be treated as household waste. Instead it should be taken to the appropriate collection point for the recycling of electrical and electronic equipment. By ensuring this product is disposed of correctly, you will help prevent potential negative consequences for the environment and human health, which could otherwise be caused by inappropriate waste handling of this product. For more detailed information about recycling of this product, please contact your local council, your household waste disposal service or the shop where you purchased the product.

### Packaging materials

The materials with the symbol  are recyclable. Dispose the packaging in a suitable collection containers to recycle it.

### Disposal of the appliance

As a responsible supplier, we care about the environment. As such, we ask that you follow the correct disposal procedures for your product and packaging. This will help ensure that your product

## **Safety information**

---

is recycled in a manner that protect the environment and your health.

You must dispose of your product and packaging according to local laws and regulations. Because this product contains electronic components and possibly batteries, this product and its accessories must be disposed separately from your household waste when the product reaches end of life. Contact your local authority to learn about disposal and recycling. The product should be taken to your local collection point for recycling. Please note that regulations may change, so always consult with your local authorities at time of disposal.

# Overview

---

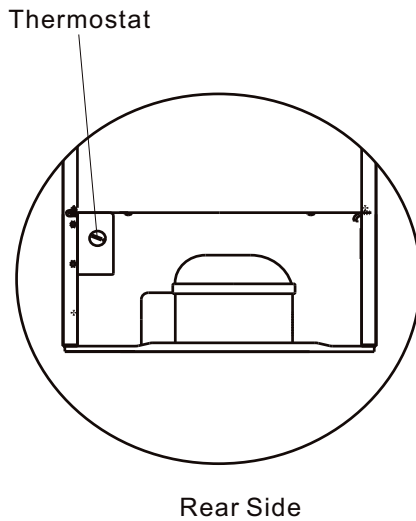
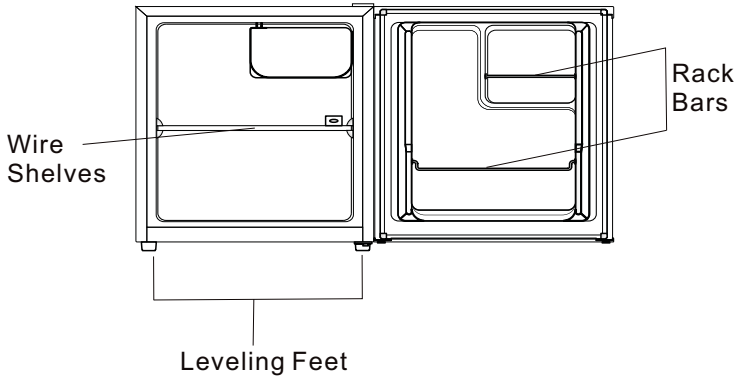

Note: Above picture is for reference only.

# Door Reversal

---

**Tools required:** Philips screwdriver, Flat bladed screwdriver, Hexagonal spanner.

- Ensure the unit is unplugged and empty.
- To take the door off, it is necessary to tilt the unit backwards. You should rest the unit on something solid so that it will not slip during the door reversing process.
- All parts removed must be saved to do the reinstallation of the door.
- Do not lay the unit flat as this may damage the coolant system.
- It's better that 2 people handle the unit during assembly.

1. Remove the top right hinge cover.

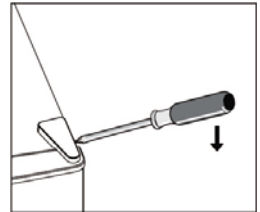

2. Undo the screws. Then remove the hinge bracket.

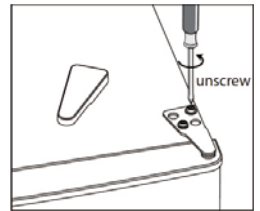

3. Remove the top left screw cover.

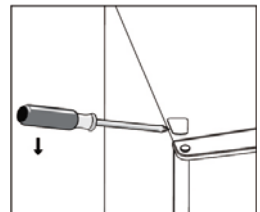

4. Move the core cover from left side to right side. And then lift the upper door and place it on a padded surface to prevent it from scratching.

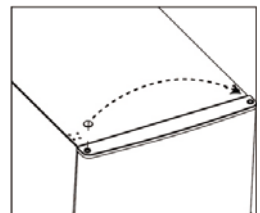



# Door Reversal

5. Unscrew and remove the bottom hinge pin, turn the bracket over and replace it.

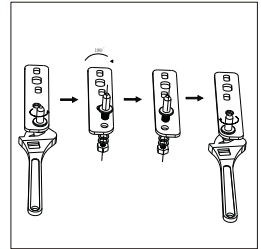
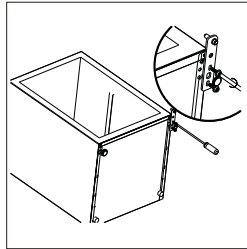

6. Refit the bracket fitting the bottom hinge pin. Replace both adjustable feet.

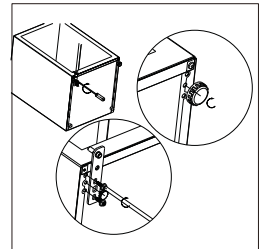

7. Place the door back on. Ensure the door is aligned horizontally and vertically so that the seals are closed on all sides before finally tightening the top hinge.

8. Insert the hinge bracket and screw it to the top of the unit.

9. Use a spanner to tighten it if necessary.

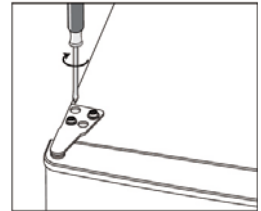

10. Put the hinge cover and the screw cover back.

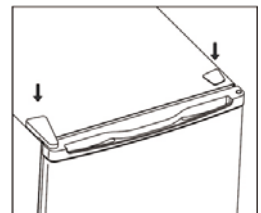

# Installation

---

## Space Requirement

- Keep enough space to allow the door to open freely.
- Keep at least 50mm gap at the two sides.

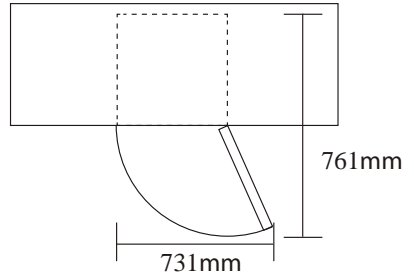

## Levelling the unit

To do this adjust the two levelling feet at front of the unit.

If the unit is not level, the doors and magnetic seal alignments will not be function effectively.

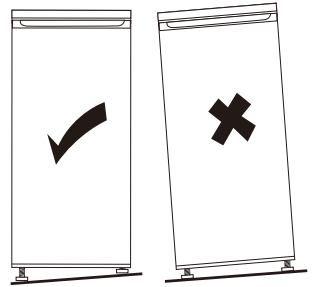

# Installation

---

## Positioning

Install this appliance at a location where the ambient temperature corresponds to the climate class indicated on the rating plate of the appliance:

Climate class	Ambient temperature
SN	+10°C to +32°C
N	+16°C to +32°C
ST	+16°C to +38°C
T	+16°C to +43°C

## Location

The appliance should be installed well away from sources of heat such as radiators, boilers, direct sunlight etc. Ensure that air can circulate freely around the back of the cabinet. To ensure best performance, if the appliance is positioned below an overhanging wall unit, the minimum distance between the top of the cabinet and the wall unit must be at least 100 mm. Ideally, however, the appliance should not be positioned below overhanging wall units. Accurate leveling is ensured by one or more adjustable feet at the base of the cabinet.

 **Warning!** It must be possible to disconnect the appliance from the mains power supply; the plug must therefore be easily accessible after installation.

## Electrical connection

Before plugging in, ensure that the voltage and frequency shown on the rating plate correspond to your domestic power supply. The appliance must be earthed. The power supply cable plug is provided with a contact for this purpose. If the domestic power supply socket is not earthed, connect the appliance to a separate earth in compliance with current regulations, consulting a qualified electrician. The manufacturer declines all responsibility if the above safety precautions are not observed. This appliance complies with the E.E.C. Directives.

# Daily Use

---

## First use

### Cleaning the interior

Before using the appliance for the first time, wash the interior and all internal accessories with lukewarm water and some neutral soap so as to remove the typical smell of a brand new product, then dry thoroughly.

**Important!** Do not use detergents or abrasive powders, as these will damage the finish.

## Temperature Setting

- Plug on your appliance. The internal temperature is controlled by a thermostat. There are 6 settings . 1 is warmest setting and 5 is coldest setting and 0 is off.
- The appliance may not operate at the correct temperature if it is in a particularly hot or if you open the door often.

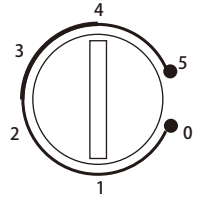

## Daily use

### Movable shelves

All shelves are able to be moved to suitable positions.

### Positioning the door shelves

In order to storage food or beverage with different size, the door shelves can be placed at different height. Follow below process to adjust the shelves.

- Step 1. pull the shelf to be free.
- Step 2. Select suitable position and press the shelf to two convex plates until it is totally blocked.

### Vegetable Drawer

The drawer is suitable for storing fruit and vegetables. It can be pull out freely.

### Thawing

Deep-frozen or frozen food, prior to be used, can be thawed in a fridge compartment or at room temperature. Place the frozen food in a dish or bowl to avoid the flowing of condensate water when thaw it in compartment.

## Helpful hints and tips

### Hints for fresh food refrigeration

To obtain the best performance:

- do not store warm food or evaporating liquids in the refrigerator
- do cover or wrap the food, particularly if it has a strong flavor
- position food so that air can circulate freely around it

### Hints for refrigeration

Useful hints:

- Meat (all types): wrap in polythene bags and place on the glass shelf above the vegetable drawer. For safety, store in this way only one or two days at the most.
- Cooked foods, cold dishes, etc.: these should be covered and may be placed on any shelf.
- Fruit and vegetables: these should be thoroughly cleaned and placed in the vegetable drawer.

## Daily Use

---

- Butter and cheese: these should be placed in special airtight containers or wrapped in aluminium foil or polythene bags to exclude as much air as possible.
- Milk bottles: these should have a cap and should be stored in the bottle rack on the door. Bananas, potatoes, onions and garlic, if not packed, must not be kept in the refrigerator.

## Cleaning

For hygienic reasons the appliance interior, including interior accessories, should be cleaned regularly.



**Caution!** The appliance may not be connected to the mains during cleaning. Danger of electrical shock! Before cleaning switch the appliance off and remove the plug from the mains, or switch off or turn out the circuit breaker or fuse. Never clean the appliance with a steam cleaner. Moisture could accumulate in electrical components, danger of electrical shock! Hot vapors can lead to the damage of plastic parts. The appliance must be dry before it is placed back into service.

**Important!** Ethereal oils and organic solvents can attack plastic parts, e.g. lemon juice or the juice from orange peel, butyric acid, cleanser that contain acetic acid.

- Do not allow such substances to come into contact the appliance parts.
- Do not use any abrasive cleaners
- Remove the food from the freezer. Store them in a cool place, well covered.
- Switch the appliance off and remove the plug from the mains, or switch off or turn out the circuit breaker of fuse.
- Clean the appliance and the interior accessories with a cloth and lukewarm water. After cleaning wipe with fresh water and rub dry.
- Accumulation of dust at the condenser increases energy consumption. For this reason carefully clean the condenser at the back of the appliance once a year with a soft brush or a vacuum cleaner.<sup>1)</sup>
- After everything is dry place appliance back into service.

# Daily Use

## Troubleshooting

 **Caution!** Before troubleshooting, disconnect the power supply. Only a qualified electrician or competent person must do the troubleshooting that is not in this manual.

**Important!** There are some sounds during normal use (compressor, refrigerant circulation).

Problem	Possible cause	Solution
Appliance does not work	Temperature regulation knob is set at number "0".	Set the knob at other number to switch on the appliance.
	Mains plug is not plugged in or is loose	Insert mains plug.
	Fuse has blown or is defective	Check fuse, replace if necessary.
	Socket is defective	Mains malfunctions are to be corrected by an electrician.
The food is too warm.	Temperature is not properly adjusted.	Please look in the initial Temperature Setting section.
	Door was open for an extended period.	Open the door only as long as necessary.
	A large quantity of warm food was placed in the appliance within the last 24 hours.	Turn the temperature regulation to a colder setting temporarily.
	The appliance is near a heat source.	Please look in the installation location section.
Appliance cools too much	Temperature is set too cold.	Turn the temperature regulation knob to a warmer setting temporarily.
Unusual noises	Appliance is not level.	Re-adjust the feet.
	The appliance is touching the wall or other objects.	Move the appliance slightly.
	A component, e.g. a pipe, on the rear of the appliance is touching another part of the appliance or the wall.	If necessary, carefully bend the component out of the way.

If the malfunction shows again, contact the Service Center. These data are necessary to help you quickly and correctly. Write the necessary data here, refer to the rating plate.

TCL Electronics Australia Pty Ltd.  
ABN 83 111 032 896  
Telephone: 1300 738 149  
[sales.au@tcl.com](mailto:sales.au@tcl.com)  
[www.tcl.com/au](http://www.tcl.com/au)