

SHARP®



R-890E (W)
R-890E (ST)
R-890E (BS)

Convection Microwave Oven with grill

OPERATION MANUAL WITH COOKING GUIDE

Read all instructions carefully before using the oven

SHARP

WARRANTY

Consumer Electronic Products

Congratulations on Your Purchase!

This Sharp product is warranted against faults in material and manufacture for the period as stated in the table below.

If service is required during the warranty period, please contact your nearest Sharp Approved Service Centre. These repairs would be carried out at no charge to the owner, subject to the conditions specified herein.

This warranty does not extend to defects or injuries caused by or resulting from causes not attributable to faulty parts or the manufacture of the product, including but not limited to, defect or injury caused by or resulting from misuse, abuse, neglect, lack of maintenance, accidental damage, improper voltage, liquid spillage, vermin infestation, software, or any alterations made to the product which are not authorised by Sharp.

Please retain your sales documentation, as this should be produced to validate a warranty claim. This warranty is in addition to and in no way limits, varies or excludes any implied rights and remedies under any relevant legislation in the country of sale.

This warranty does not cover transportation to and from the Sharp Approved Service Centre. Goods presented for repair may be replaced by refurbished goods of the same type rather than being repaired. Refurbished parts may be used to repair the goods. The repair of your goods may result in the loss of user generated data, please ensure that you have saved this data elsewhere prior to repair.

Australian customers: Our goods come with guarantees that cannot be excluded under the Australian Consumer Law. You are entitled to a replacement or refund for a major failure and for compensation for any other reasonably foreseeable loss or damage. You are also entitled to have the goods repaired or replaced if the goods fail to be of acceptable quality and the failure does not amount to a major failure. The criteria of a major failure is defined in the Australian Consumer Law. Should you require any assistance with a major failure please contact Sharp Customer Care.

WARRANTY PERIODS

Home Theatre Projector	12 months (excluding lamps and air filters)
Audio/Home Theatre	12 months
Microwave Oven	12 months
Steam Oven	12 months
Refrigerator	24 months
DVD/Blu-ray	12 months
Air Conditioner	60 months
Portable Air Conditioner	12 months
LCD Television	36 months
Air Purifier	12 months

SHARP
SHARP CORPORATION OF AUSTRALIA PTY LIMITED
ABN 40 003 039 405
2 JULIUS AVENUE,
NORTH RYDE NSW 2113
SHARP CORPORATION OF NEW ZEALAND LIMITED
59 Hugo Johnston Drive
Petross, Auckland

IMPORTANT NOTICE: This warranty applies only to products sold in Australia & New Zealand

SHARP

FOR LOCATION ENQUIRIES WITHIN

AUSTRALIA

REGARDING YOUR LOCAL

SHARP APPROVED SERVICE CENTRE

VISIT OUR WEBSITE AT

www.sharp.net.au

OR CALL SHARP CUSTOMER CARE

1300 135 022

(LOCAL CALL COST APPLY WITHIN AUSTRALIA)

SHARP CORPORATION OF AUSTRALIA PTY LTD

SHARP

FOR LOCATION ENQUIRIES WITHIN

NEW ZEALAND

REGARDING YOUR LOCAL

SHARP APPROVED SERVICE CENTRE

VISIT OUR WEBSITE AT

www.sharp.net.nz

CONTACT YOUR SELLING DEALER/RETAILER
OR CALL

SHARP CUSTOMER CARE

TELEPHONE: 09 573 0111

FACSIMILE: 09 573 0113

SHARP CORPORATION OF NEW ZEALAND LIMITED

INTRODUCTION

SHARP®

Thank you for buying a Sharp Microwave Oven.
Please keep this operation manual handy, as it describes all the features of your oven and will enable you to cook a variety of foods.

The manual is divided into two sections:

1. OPERATION (P2~P25)

This section describes your oven and teaches you how to use all the features.

2. SMART COOKING GUIDE

This section is at the back of the manual, it contains the more commonly used information such as how to prepare food, which cooking utensil to use and standing times. It also contains recipes for automatic cooking.

Please take some time to read your operation manual carefully, the automatic cooking menus programmed into your new oven have been carefully developed to give optimum results when the step-by-step instructions are followed.

When selecting another home appliance, please again consider our full range of Sharp products.

CONTENTS Page

Warranty	Inside of front cover
Introduction	1
Warning	2
Special Notes	3
Installation Instructions	4
Oven Diagram	5
Operation of Touch Control Panel	6
Control Panel Display	6
Touch Control Panel Layout	6
Before Operating	7
Getting Started	7
Clock Set Mode (Clock Setting)	7
Set Timer	8
Stop/Clear	8
To Cancel a Program During Cooking	8
Manual Operations	9
<Microwave Cooking>	9
Microwave Time Cooking	9
Instant Cook	11
<Heating without Food>	12
<Convection Cooking>	13
To Cook by Convection	13
To Preheat and Cook by Convection	14
Convection and Microwave Cooking	15
<Combi Cooking>	16
<Multiple Sequence Cooking>	17
Inverter Microwave Cook	19
<Automatic Menus>	20
Fan-Forced Cook	20
Convenience Cook	21
Favourite	22
Child Lock	23
Care and Cleaning	24
Service Call Check	25
Specifications	25
Smart Cooking Guides	①-⑳

WARNING

IMPORTANT SAFETY INSTRUCTIONS : READ CAREFULLY AND KEEP FOR FUTURE REFERENCE.

Whenever the top heater, bottom heater or convection symbols are displayed the turntable, turntable support, racks, oven door, outer cabinet, oven cavity and especially bottom heater will become very hot. To prevent yourself from getting burnt use thick oven mittens.

Do not put things on top of the oven or cover the outer cabinet.

Accessible parts (eg. oven door, turntable and rack) will become hot when in use.

To avoid burns and scalds children should be kept away.

To reduce the risk of fire in the oven cavity:

- a. Do not overcook food.
- b. Remove wire twist-ties from paper or plastic bags before placing bag in the oven.
- c. Do not heat oil or fat for deep frying. The temperature of the oil cannot be controlled.
- d. Look at the oven from time to time when food is heated in disposable containers made of plastic, paper or other combustible materials for signs of smoke or burning.
- e. If materials inside the oven should ignite, or smoke is observed, keep oven door closed, turn oven off, and disconnect the power cord, or shut off power at the fuse or circuit breaker panel.

To reduce the risk of an explosion or delayed eruptive boiling:

Your microwave oven is capable of heating food and beverages very quickly therefore, it is very important that you select the appropriate cooking time and power level for the type and quantity of food to be heated. If you are unsure of the cooking time and power level required, begin with low cooking times and power levels until the food is sufficiently heated evenly throughout.

Additionally:

- a. Do not place sealed containers in the oven. Baby bottles fitted with a screw cap or teat are considered to be sealed containers.
- b. Do not use excessive amounts of time.
- c. When boiling liquids in the oven, use a wide-mouthed container.
- d. Stand at least for 20 seconds at the end of cooking to avoid delayed eruptive boiling of liquids.
- e. Stir the liquid before and during cooking. Use extreme care when handling the container or inserting a spoon or other utensil into the container.

This oven is for home food preparation only and should only be used for heating, cooking and defrosting food and beverage. It is not suitable for commercial, laboratory use, or heating therapeutic devices eg. Wheat bags.

Never operate the oven whilst any object is caught or jammed between the door and the oven.

Do not try to adjust or repair the oven yourself.

It is hazardous for anyone other than a qualified service technician trained by SHARP to carry out any service or repair operation. Especially those which involve the removal of a cover which gives protection against exposure to microwave energy are very hazardous.

Do not operate the oven if it is not working correctly or damaged until it has been repaired by a qualified service technician trained by SHARP. It is particularly important that the oven door closes properly and that there is no damage to:

(1) Door (warped), (2) Hinges and Latches (broken or loosened), (3) Door Seals, Sealing Surfaces and oven cavity (buckled or deformed), (4) Burn marks on the door seal faces.

Do not bump, or catch utensils, loose clothes and your accessories on the door safety latches when removing food from the oven.

Never poke an object, particularly a metal object, through a grille or between the door and the oven while the oven is operating.

Never tamper with or deactivate the door safety latches.

Always use oven mittens to prevent burns when handling utensils that are in contact with hot food. Enough heat from the food can transfer through utensils to cause skin burns.

Should the power supply cord become damaged, it must be replaced with a special cord supplied by a SERVICE CENTRE APPROVED BY SHARP. And it must be replaced by a qualified service technician trained by SHARP.

If the oven lamp fails please consult your dealer or a qualified service technician trained by SHARP.

Avoid steam burns by directing steam away from the face and hands.

Slowly lift the furthest edge of a dish's cover and microwave plastic wrap and carefully open popcorn and oven cooking bags away from the face.

Make sure that the power supply cord is undamaged, and that it does not run under the oven or over any hot surfaces or sharp edges.

Do not place anything on the outer cabinet because the microwave oven will become very hot during the operation.

Do not store food or any other items inside the oven.

Make sure the utensil does not touch the interior walls during cooking.

Only allow children to use the oven without supervision when adequate instructions have been given so that the child is able to use the oven in a safe way and understands the hazards of improper use.

Children should be supervised to ensure that they do not play with the appliance.

This appliance is not intended for use by persons (including children) with reduced physical, sensory or mental capabilities, or lack of experience and knowledge, unless they have been given supervision or instruction concerning use of the appliance by a person responsible for their safety.

SPECIAL NOTES

	DO	DON'T
Eggs, fruits, nuts, seeds, vegetables, sausages and oysters	<ul style="list-style-type: none"> * Puncture egg yolks and whites and oysters before cooking to prevent "explosion". * Pierce skins of potatoes, apples, squash, hot dogs, sausages and oysters so that steam escapes. 	<ul style="list-style-type: none"> * Cook eggs in shells. This prevents "explosion", which may damage the oven or injure yourself. * Reheat whole eggs. * Overcook oysters. * Dry nuts or seeds in shells.
Popcorn	<ul style="list-style-type: none"> * Use specially bagged popcorn for the microwave oven. * Listen while popping corn for the popping to slow to 1-2 seconds. 	<ul style="list-style-type: none"> * Pop popcorn in regular brown bags or glass bowls. * Exceed maximum time on popcorn package.
Baby food	<ul style="list-style-type: none"> * Transfer baby food to a small dish and heat carefully, stirring often. Check for suitable temperature to prevent burns. * Remove the screw cap and teat before warming baby bottles. After warming shake thoroughly. Check for suitable temperature. 	<ul style="list-style-type: none"> * Heat disposable bottles. * Overheat baby bottles. Only heat until warm. * Heat bottles with teats on. * Heat baby food in original jars.
General	<ul style="list-style-type: none"> * Food with filling should be cut after heating, to release steam and avoid burns. * Use a deep bowl when cooking liquids or cereals to prevent boiling over. 	<ul style="list-style-type: none"> * Heat or cook in closed glass jars or air tight containers. * Deep fry fat. * Heat or dry wood, herbs, wet papers, clothes or flowers. * Operate the oven without a load (i.e. an absorbing material such as food or water) in the oven cavity except when conditioning or cleaning the heater elements as described in the operation manual.
Liquids (Beverages)	<ul style="list-style-type: none"> * For boiling or cooking liquids see WARNING on page 2 to prevent explosion and delayed eruptive boiling. 	<ul style="list-style-type: none"> * Heat for longer than recommended time. See REHEATING-FOOD CHART on page 37.
Canned foods	<ul style="list-style-type: none"> * Remove food from can. 	<ul style="list-style-type: none"> * Heat or cook food while in cans.
Sausage rolls, pies, Christmas pudding	<ul style="list-style-type: none"> * These foods have high sugar and/or fat contents. * Cook for the recommended time. 	<ul style="list-style-type: none"> * Overcook as they may catch fire.
Meats	<ul style="list-style-type: none"> * Use a microwave proof roasting rack to collect drained juices. 	<ul style="list-style-type: none"> * Place meat directly on the turntable for cooking.
Utensils	<ul style="list-style-type: none"> * Check the utensils are suitable for MICROWAVE cooking before you use them. 	<ul style="list-style-type: none"> * Use metal utensils for MICROWAVE cooking. Metal reflects microwave energy and may cause an electrical discharge known as arcing.
Aluminium foil	<ul style="list-style-type: none"> * Use to shield food to prevent over cooking. * Watch for sparking. Reduce foil or keep clear of cavity walls. 	<ul style="list-style-type: none"> * Use too much. * Shield food close to cavity walls. Sparking can damage the cavity.
Browning dish	<ul style="list-style-type: none"> * Place a suitable insulator such as a microwave and heat proof dinner plate between the turntable and the browning dish. 	<ul style="list-style-type: none"> * Exceed the preheating time recommended by the manufacturer. Excessive preheating can cause the glass turntable to shatter and/or damage internal parts of the oven.

INSTALLATION INSTRUCTIONS

1. Remove all packing materials from the oven cavity, **(do not remove the waveguide cover)**, and the feature sticker from the outside of the door, if there is one. Check the unit for any damage, such as a misaligned door, damaged door seals around the door or dents inside the oven cavity or on the door. If there is any damage, please do not operate the oven until it has been checked by a SERVICE CENTRE APPROVED BY SHARP and repaired, if necessary.

2. Accessories provided

1) Turntable 2) Turntable Ring 3) Rack 4) Combined operation manual and cookbook

3. Since the door may become hot during cooking, you should place or mount the oven so that the bottom of the oven is 85 cm or more above floor. You should also keep children away from the door to prevent them burning themselves.

This oven is designed to be used on a countertop, in a cabinet or built-in(not available in all countries).

It should not be installed in any area where excessive heat and steam are generated, for example, next to a conventional oven unit. The oven should be installed so as not to block ventilation openings.

For R-890E(W)/(ST)/(BS): Allow a space of at least 40cm on the top, 5cm on both sides and at the rear of the oven for adequate air circulation. When installing in a cabinet, the minimum inside dimension of the cabinet should be 620mm(W) x 715mm(H) x 560mm(D).

WARNING: The electrical outlet must be readily accessible so that the unit can be unplugged easily in an emergency.

4. Neither the manufacturer nor the distributors can accept any liability for damage to the machine or personal injury for failure to observe the correct electrical connecting procedure.

The A.C. voltage must be single phase 230-240V, 50Hz.

5. This appliance must be earthed.

6. Operate the oven from a general purpose domestic outlet. If a generator is used, do not operate the oven with non-sinusoidal outputs.

7. Before using the grill for the first time, operate the oven without food for 20 minutes.

This will allow the oil that is used for rust protection to be burned off.

OVEN DIAGRAM

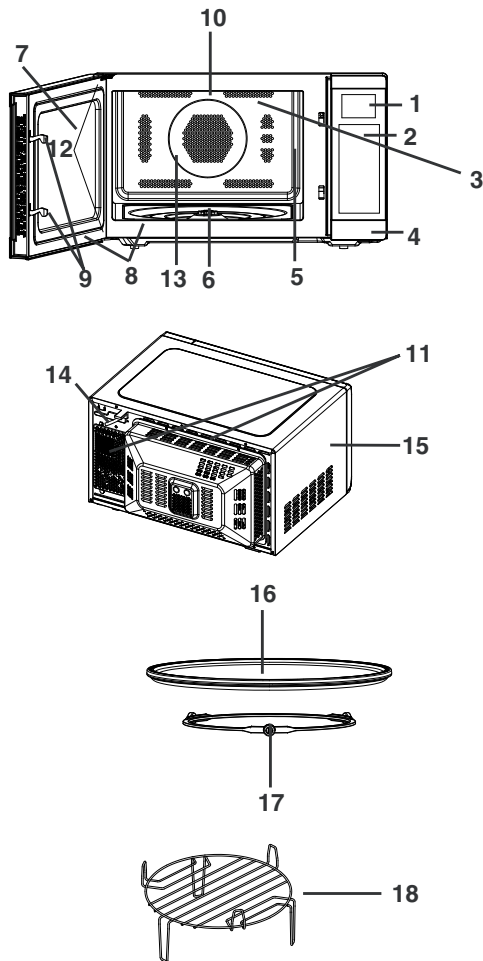

OVEN:

1. LED Display
2. Control panel
3. Oven lamp
4. Door open button
5. Waveguide cover (Do not remove)
6. Coupling
7. See through door
8. Door seals and sealing surfaces
9. Door safety latches
10. Top grill heating element
11. Ventilation openings
12. Door hinges
13. Oven cavity
14. Power supply cord
15. Outer cabinet

ACCESSORIES:

16. Turntable
 17. Roller stay
 18. Rack
- Place the turntable onto the turntable motor shaft, ensuring it is located firmly.
 - To avoid turntable damage, ensure dishes or containers are lifted clear of the turntable rim when removing them from the oven.
 - The racks are for Grill, Combi., Convection and recommended automatic operations.

Never touch the grill when it is hot.

NOTES:

- The waveguide cover is fragile. Care should be taken when cleaning inside the oven to ensure that it is not damaged.
- After cooking fatty foods without a cover, always clean the cavity and especially the grill heating elements thoroughly, these must be dry and free from grease. Built-up grease may overheat and begin to smoke or catch fire.
- Always operate the oven with the turntable fitted correctly. This promotes thorough, even cooking. A badly fitted turntable may rattle, may not rotate properly and could cause damage to the oven.
- The turntable rotates clockwise or anti-clockwise. The rotary direction may change each time you start the oven. This does not affect cooking performance.

Warning:

The accessories will become very hot whenever the the grill or convection symbols are lit on the display. Use thick oven mittens when inserting/removing the food or turntable from the oven to prevent burns.

Information on Disposal

This product should not be disposed of in a general waste bin as it contains materials that should be recycled, which is good for the environment.

If you are in doubt about the correct disposal method, contact your local council.

OPERATION OF TOUCH CONTROL PANEL

The operation of the oven is controlled by pressing the appropriate pads arranged on the surface of the control panel. An entry signal tone should be heard each time you press the control panel to make a correct entry. In addition the oven will beep for approximately 2 seconds at the end of the cooking cycle, or 4 times when a cooking procedure is required.

Control Panel Display

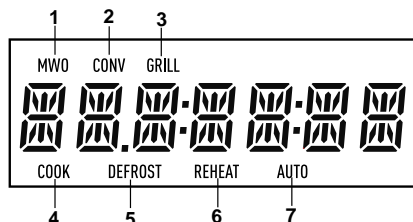

1. **MICROWAVE SYMBOL**
It will appear when setting a program using the microwave mode, or when in a microwave cooking mode.
2. **CONVECTION SYMBOL**
It will appear when setting a program using the convection mode, or when in a convection cooking mode.
3. **GRILL SYMBOL**
It will appear when setting a program using the grill mode, or when in a grill cooking mode.
4. **COOK indicator**
It will light up when the oven is operating.
5. **DEFROST SYMBOL**
It will appear when setting a program using the defrost mode, or when in a defrost cooking mode.
6. **REHEAT SYMBOL**
It will appear when setting a program using the reheat mode, or when in a reheat cooking mode.
7. **AUTO SYMBOL**
It will appear when setting a program using the auto menu mode, or when in a auto cooking mode.

Touch Control Panel Layout

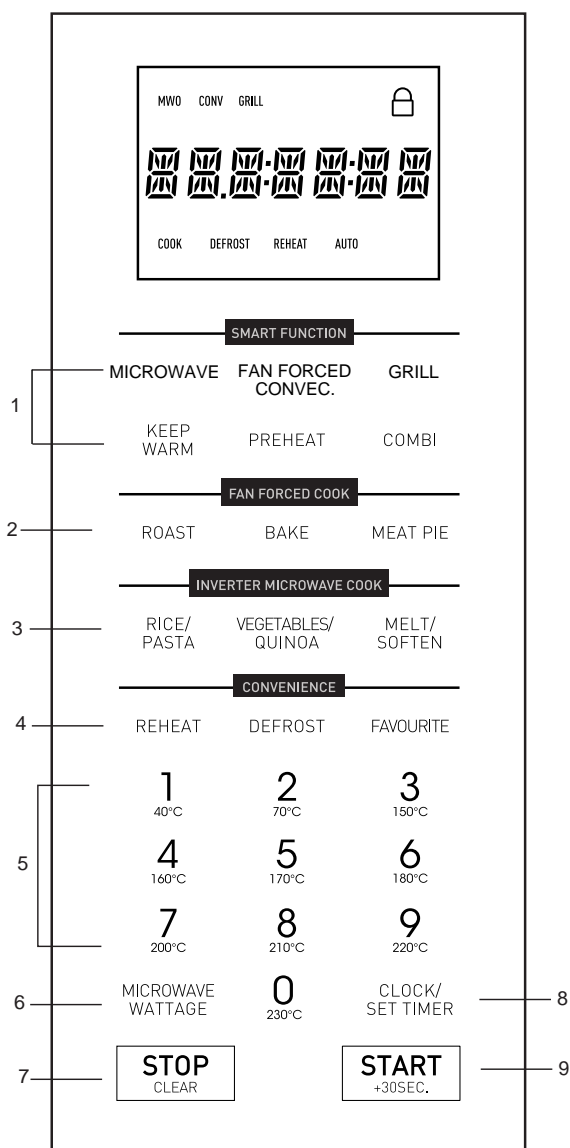

1. **SMART FUNCTION pads**
Press to select cooking mode option.
2. **FAN FORCED COOK pads**
Press to select 3 popular convection menus.
3. **INVERTER MICROWAVE COOK pads**
Press to select 6 popular menus.
4. **CONVENIENCE pads**
Press to select Reheat, Defrost or Favourite key.
5. **NUMBER AND TEMPERATURE pads**
Press to enter cooking times, clock time, convection temperature, weight or quantity of food.
6. **MICROWAVE WATTAGE pad**
Press to select microwave power setting. If not pressed, 1100W is automatically selected.
7. **STOP/CLEAR pad**
Press to clear during programming. Press once to stop operation of oven during cooking; press twice to cancel cooking program.
8. **CLOCK/SET TIMER pad**
Press to set clock time or timer.
9. **START/+30SEC.pad**
Press once to cook for 30 seconds at 1100W or increase by 30 second multiples each time this pad is pressed during manual cooking. Press to start oven after setting programs.

BEFORE OPERATING

Getting Started

Step	Procedure	Pad Order	Display
1	Plug the oven into a power point and switch on the power. Ensure the oven door is closed.		MICRO- WAVE OVEN
2	Press the STOP/CLEAR pad.	STOP CLEAR	0

Clock Setting

* To enter the present time of day 11:34 (AM or PM).

Step	Procedure	Pad Order	Display
1	Press the CLOCK/SET TIMER pad once.	CLOCK/ SET TIMER x 1	SET CLOCK PRESS START
2	Press the START/+30SEC. pad.	START +30SEC.	ENTER TIME PRESS START TO SET
3	Enter the correct time of day by pressing the numbers in sequence.	1 1 3 4	11:34 The dots (:) will flash on and off.
4	Press the START/+30SEC. pad.	START +30SEC.	11:34

This is a 12 hour clock. If you attempt to enter an incorrect clock time (eg. 13:45), ENTER TIME PRESS START TO SET will appear on the display. Press the STOP/CLEAR pad and re-enter the time of day (eg. 1:45).

Set Timer

Use this feature as a general purpose timer. Examples include:
 timing boiled eggs cooked on the stove top.
 timing the recommended standing time of food.

You can enter any time up to 99 minutes, 99 seconds. If you want to cancel the timer during the count down phase simply press STOP/CLEAR.

* Suppose you want to set the timer for 3 minutes to boil an egg on the stove top.

Step	Procedure	Pad Order	Display
1	Press the CLOCK/SET TIMER pad twice.	CLOCK/ SET TIMER x 2	SET TIMER PRESS START
2	Press the START/+30SEC. pad.	START +30SEC.	ENTER TIME PRESS START
3	Enter desired time.	3 0 0	03:00
4	Press the START/+30SEC. pad.	START +30SEC.	3:00 The timer begins to count down. When the timer reaches zero, the oven will "beep".

Stop/Clear

Press the STOP/CLEAR pad once to:

1. Stop the oven temporarily during cooking.
2. Clear if you make a mistake during programming.
3. Clear the message on the display after cooking.

To Cancel a Program During Cooking

Press the STOP/CLEAR pad twice.

MANUAL OPERATIONS

<Microwave Cooking>

Microwave Time Cooking

This is a manual cooking feature, first enter the cooking time then the power level.

There are eleven different power levels. You can program up to 99 minutes, 99 seconds.

This variable cooking control allows you to select the rate of microwave cooking.

After cooking, the fan will continue to operate. COOLING may be displayed when the door is opened or STOP/CLEAR pad is pressed while the fan is operating.

Display	Power level		Examples
	Power level	Power level	
1100 W	100%	High	Raw meat, Vegetables, Rice or Pasta
990 W	90%		
880 W	80%		
770 W	70%	Medium High	Delicate Food such as Eggs or Seafood.
660 W	60%		
550 W	50%	Medium	
440 W	40%		
330 W	30%	Medium Low	Defrost, Softening butter
220 W	20%		
100 W	10%	Low	Keep food warm
0 W	0%		

If a wattage level is not selected, then 1100W is automatically used.

*Suppose you want to cook for 10 minutes at 1100W.

Step	Procedure	Pad Order	Display
1	Enter desired cooking time.	1 0 0 0	MW 10:00
2	Press the START/+30SEC. pad.	START +30SEC.	MW 10:00 COOK The timer begins to count down.



MANUAL OPERATIONS

<Microwave Cooking>

Microwave Time Cooking

To lower the wattage level press the MICROWAVE WATTAGE pad first. Note the display will indicate "1100W PRESS AGAIN TO LOWER POWER OR PUSH START". Press the MICROWAVE WATTAGE pad again until required wattage level is displayed.

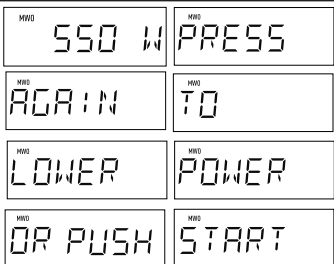
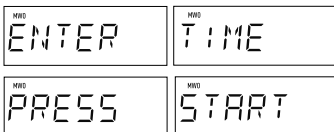
* Suppose you want to cook Fish Fillets for 10 minutes at 550W.

Step	Procedure	Pad Order	Display
1	Select power level by pressing the MICROWAVE WATTAGE pad as required (for 550W microwave wattage press six times).	MICROWAVE WATTAGE x 6	
2	Press the START/+30SEC. pad.	START +30SEC.	
3	Enter desired cooking time.	1 0 0 0	
4	Press the START/+30SEC. pad.	START +30SEC.	 The timer begins to count down.

If the door is opened during the cooking process, the cooking time in the display automatically stops. The cooking time starts to count down again when the door is closed and the START/+30SEC. pad is pressed.

HELPFUL HINTS:

If you want to check the microwave wattage during cooking, press the MICROWAVE WATTAGE pad. As long as your finger is pressing the MICROWAVE WATTAGE pad, the microwave wattage will be displayed.



Instant Cook

For your convenience Sharp's Instant Cook allows you to easily cook for 30 seconds at 1100W. The Instant Cook function has 2 operation methods (see below).

Each time the START/+30SEC pad is pressed, the cooking time is increased by 30 seconds up to a maximum time of 99 minutes.







<Not during cooking>

* Suppose you want to cook for 1 minute at 1100W.

Step	Procedure	Pad Order	Display
1	Press the START/+30SEC. pad. Within 3 minutes of closing the door, cooking completion or pressing the STOP/CLEAR pad.	 x 2	 The timer begins to count down.



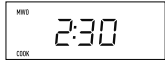
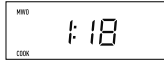

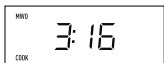
<During cooking in Manual Operation>

* Suppose you want to cook for 2 minutes 30 seconds at 1100W and add 2 minutes during cooking.

Step	Procedure	Pad Order	Display
1	Enter desired cooking time.	  	
2	Press the START/+30SEC. pad.		 The timer begins to count down.
			
3	Press the START/+30SEC. pad twice.	 x 4	

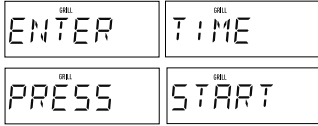
<Heating without Food>

Before the first use and after cleaning the grill must be conditioned. The procedure involves heating the grill for a period of 20 minutes. You may notice some smoke and odour during this process, this is normal, the oven is not out of order. Follow the procedure below.

Step	Procedure	Pad Order	Display
1	Ensure that no food is in the oven. Press the GRILL pad.		
2	Enter the heating time (20 min.).		
3	Press the START/+30SEC. pad. IMPORTANT: During this operation, some smoke and odour will occur. Therefore open the windows or run the ventilation fan in the room.		 The timer begins to count down to zero. When timer reaches zero, all indicators will go out and the oven will "beep". FINISH REMOVE FOOD will be displayed
4	Open the door to cool the oven cavity. The cooling fan will remain on until the oven cavity has cooled. WARNING: The oven door, outer cabinet, turntable and oven cavity will be hot to PREVENT BURNS allow the oven to cool.		



<Convection Cooking>

Please consult your Convection Microwave Cookbook for more specific cooking instructions and procedures.

To Cook by Convection

Your Convection Microwave Oven can be programmed for ten different convection cooking temperatures (230, 220, 210, 200, 180, 170, 160, 150, 70, 40 °C) up to 99 minutes, 99 seconds.

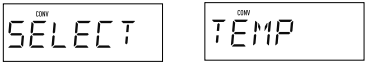
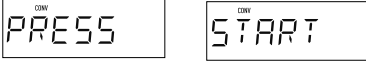
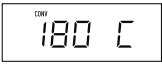
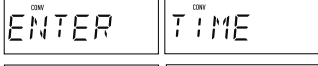
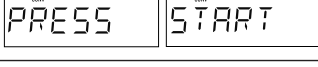
* Suppose you want to cook for 20 minutes at 180°C.

Step	Procedure	Pad Order	Display
1	Place turntable in the oven. Press the FAN FORCED CONVEC. pad.	FAN FORCED CONVEC.	 
2	Enter desired temperature.	6 180°C	
3	Press the START/+30SEC. pad.	START +30SEC.	 
4	Enter desired cooking time.	2 0 0 0	
5	Press the START/+30SEC. pad.	START +30SEC.	 <p>The timer begins to count down to zero. When the timer reaches zero, all indicators will go out and the oven will "beep". FINISH REMOVE FOOD will be displayed. The cooling fan will remain on and NOW COOLING may be displayed until the oven cavity has cooled.</p>

WARNING:

The oven cavity, door, turntable, rack, dishes and especially the grill will become very hot, use thick oven mittens when inserting/removing the food or turntable from the oven to prevent burns.









HELPFUL HINTS:

If you are cooking and wish to check the temperature you have programmed, simply press the FAN FORCED CONVEC pad. The programmed temperature will be displayed as long as FAN FORCED CONVEC. pad is pressed.

NOTE: During preheating and convection cooking, you will hear the cooling fan cycling on and off. This is completely normal and will not affect the cooking.

To Preheat and Cook by Convection

* Suppose you want to preheat the oven to 200°C then cook for 20 minutes at 200°C.

Step	Procedure	Pad Order	Display
1	Press the PREHEAT pad.		
2	Press desired preheat temperature pad.		
3	Press the START/+30SEC. pad.		**AFTER PREHEAT IS OVER, UNIT BEEPS AND DISPLAYS THE FOLLOWING MESSAGE** PLACE FOOD ENTER COOK TIME PRESS START
4	Enter desired cooking time.		
5	Press the START/+30SEC. pad.		The timer begins to count down to zero and all indicators will go off and the oven will "beep" and FINISH REMOVE FOOD will be displayed. The cooling fan will remain on and NOW COOLING may be displayed until the oven cavity has cooled.

PREHEAT

COOKING

WARNING:



The oven cavity, door, turntable, rack, dishes and especially the grill will become very hot, use thick oven mittens when inserting/removing the food or turntable from the oven to prevent burns.

NOTE: During preheating and convection cooking, you will hear the cooling fan cycling on and off. This is completely normal and will not affect the cooking.

Convection and Microwave Cooking

Your oven can be programmed to combine convection and microwave cooking operations.

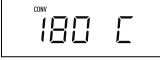
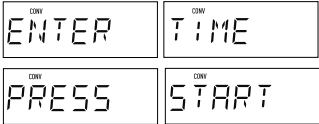
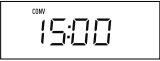
* Suppose you want to roast chicken pieces for 15 minutes at 180°C and then cook for 8 minutes at 550W.

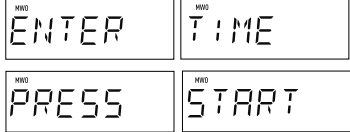
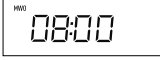
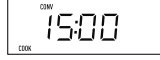
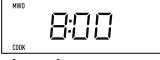
Step	Procedure	Pad Order	Display
1	Press the FAN FORCED CONVEC. pad.	FAN FORCED CONVEC.	
2	Enter desired convection temperature.	6 180°C	
3	Press the START/+30SEC. pad.	START +30SEC.	
4	Enter desired convection cooking time.	1 5 0 0	
5	Select microwave cooking and microwave wattage by pressing the MICROWAVE WATTAGE pad as required (for 550W power press 6 times.)	MICROWAVE WATTAGE x 6	
6	Press the START/+30SEC. pad.	START +30SEC.	
7	Enter desired microwave cooking time.	8 0 0	
8	Press the START/+30SEC. pad.	START +30SEC.	 <p>The timer begins to count down to zero. When it reaches zero, the second sequence will be displayed and the timer will begin to count down to zero again.</p>  <p>The timer begins to count down to zero and all indicators will go off and the oven will "beep" and FINISH REMOVE FOOD will be displayed. The cooling fan will remain on and NOW COOLING may be displayed until the oven cavity has cooled.</p>

Do not use plastic (non-heat proof) cookware if combining Convection and Microwave modes.

WARNING:

The oven cavity, door, turntable, rack, dishes and especially the grill will become very hot, use thick oven mitts when inserting/removing the food or turntable from the oven to prevent burns.

NOTE: During Preheating and Convection cooking, you will hear the cooling fan cycling on and off. This is completely normal and will not affect the cooking.





<COMBI. Cooking>

The Smart COMBI Cooking feature enables a combination of cooking modes to be used alternately. Combination cooking reduces cook time and provides a crisp, brown finish to foods.

To use the Smart COMBI feature press the COMBI pad until the desired program is displayed. It is not necessary to preheat for combination cooking.

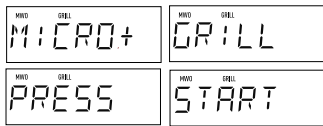
COMBI	C-1	C-2	C-3	C-4
	Microwave+Convection	Microwave+Grill	Grill+Convection	Microwave+Grill+Convection
Microwave	●	●		●
Grill		●	●	●
Fan-Forced Convection	●		●	●

* Suppose you want to cook for 6 minutes with Microwave and Grill.

Step	Procedure	Pad Order	Display
1	Press the COMBI pad twice.	<div style="border: 1px solid black; padding: 2px; display: inline-block;">COMBI</div> x 2	
2	Press the START/+30SEC. pad.	<div style="border: 1px solid black; padding: 2px; display: inline-block;">START +30SEC.</div>	
3	Enter desired cooking time.	<div style="display: flex; gap: 10px;"> <div style="border: 1px solid black; padding: 2px; display: inline-block;">6</div> <div style="border: 1px solid black; padding: 2px; display: inline-block;">○</div> <div style="border: 1px solid black; padding: 2px; display: inline-block;">○</div> </div>	
4	Press the START/+30SEC. pad.	<div style="border: 1px solid black; padding: 2px; display: inline-block;">START +30SEC.</div>	 <p>The timer begins to count down to zero and all indicators will go off and the oven will "beep" and FINISH REMOVE FOOD will be displayed. The cooling fan will remain on and NOW COOLING may be displayed until the oven cavity has cooled.</p>

WARNING:





The oven cavity, door, turntable, rack, dishes and especially the grill will become very hot, use thick oven mittens when inserting/removing the food or turntable from the oven to prevent burns.

<Multiple Sequence Cooking>



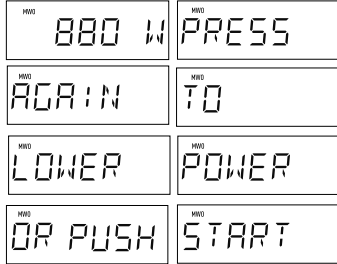

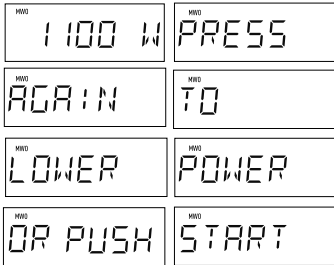
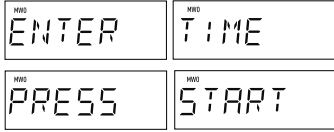
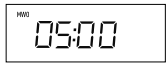
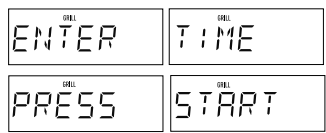
Preheating, Microwave Cooking, Convection Cooking, Grill Cooking and COMBI Cooking can be programmed to up to 4 automatic cooking sequences, switching from one variable power setting to another.

Note that MICROWAVE WATTAGE must be entered first when programming sequence cooking.

* Suppose you want to cook for 10 minutes at 880W microwave power, cook for 5 minutes at 1100W and cook with Grill for 20 minutes.

Step	Procedure	Pad Order	Display
1	Select microwave cooking and desired wattage level by pressing the MICROWAVE WATTAGE pad (for 880W microwave power press three times).	MICROWAVE WATTAGE x 3	
2	Press the START/+30SEC. pad.	START +30SEC.	
3	Enter desired cooking time.	1 0 0 0	
4	For second sequence, select microwave cooking and wattage level (for 1100W press the MICROWAVE WATTAGE pad once)	MICROWAVE WATTAGE	
5	Press the START/+30SEC. pad.	START +30SEC.	
6	Enter desired cooking time for the second sequence.	5 0 0	
7	For third sequence, press the GRILL pad.	GRILL x 1	
8	Enter desired cooking time.	2 0 0 0	

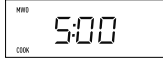
<Multiple Sequence Cooking>

Step	Procedure	Pad Order	Display
9	Press the START/+30SEC. pad.		 <p>The timer begins to count down to zero. When it reaches zero,</p>  <p>the second sequence will be displayed and the timer will begin counting down to zero again.</p>  <p>And then the third sequence will be displayed and the timer will begin counting down to zero. All indicators will go off and the oven will "beep" and FINISH REMOVE FOOD will be displayed. The cooling fan will remain on and NOW COOLING may be displayed until the oven cavity has cooled.</p>

WARNING:

The oven cavity, door, turntable, rack, dishes and especially grill will become very hot, use thick oven mittens when inserting/removing the food or turntable from the oven to prevent burns.







INVERTER MICROWAVE COOK

RICE/ PASTA	VEGETABLES/ QUINOA	MELT/ SOFTEN
----------------	-----------------------	-----------------

RICE / PASTA	VEGETABLES/QUINOA	MELT/SOFTEN
1.White Rice	1.Fresh Vegetables	1.Chocolate
2.Brown Rice	2.Frozen Vegetables	2.Butter
3.Pasta	3.Sweet Jacket Potato	3.Cream Cheese
4.Wholemeal Pasta	4.Quinoa	

Press pads until the desired menu appears on the display. Follow the details provided in the INVERTER MICROWAVE COOK MENU GUIDE on page ⑧-⑨ in the cooking guides.

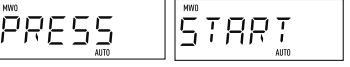
* Suppose you want to cook 150g Fresh Vegetables.

Step	Procedure	Pad Order	Display
1	Press the VEGETABLES/QUINOA pad.	VEGETABLES/ QUINOA	 
2	Press the START/+30SEC. pad.	START +30SEC.	  
3	Enter the weight.	1 5 0	
4	Press the START/+30SEC. pad.	START +30SEC.	 The timer begins to count down. The oven will "beep" 4 times and will stop. FINISH REMOVE FOOD will be displayed repeatedly.

<AUTOMATIC MENUS>

Fan Forced Cook

ROAST BAKE MEAT PIE









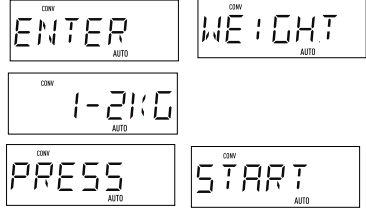

ROAST	BAKE	MEAT PIE
1. Roast Chicken	1. Butter Cake	1. Standard Pie, Refrigerated (160g)
2. Roast Beef	2. Lasagne (400g)	2. Standard Pie, Frozen (160g)
3. Roast Lamb		3. Party Pies 10
4. Roast Pork		

NOTE: For the ROAST Auto Menus the initial temperature is +3°C.

Press pads until the desired menu appears on the display.

Follow the details provided in the FAN FORCED COOK MENU GUIDE on page ⑤ - ⑥ in the cooking guides.

* Suppose you want to cook 1.0 kg Roast Beef (Medium).

Step	Procedure	Pad Order	Display
1	Press the ROAST pad.	 x 2	
2	Press the START/+30SEC. pad.		
3	Enter the weight.	  	
4	Press the START/+30SEC. pad.		 The timer begins to count down. The oven will "beep" 4 times and will stop. TURN OVER BEEF PRESS START will be displayed repeatedly.
5	Open the door. Turn over the meat. Close the door.		TURN OVER BEEF PRESS START will be displayed repeatedly.
6	Press the START/+30SEC. pad.		 When the cooking time reaches zero, FINISH REMOVE FOOD will be displayed repeatedly.

Convenience







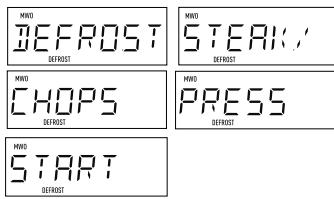

REHEAT DEFROST FAVOURITE

REHEAT	DEFROST	
1. Plate (400g)	1. Mince	4. Whole Chicken
2. Beverage	2. Steak/Chops	5. Chicken Fillet
	3. Roast Meat	6. Fish Fillet

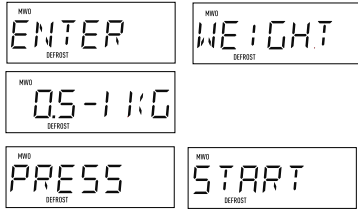
Press to select popular reheat and defrost menus.

Follow the details provided in the CONVENIENCE MENU GUIDE on page ⑦ in the cooking guides.

* Suppose you want to defrost 0.5 kg steak.

Step	Procedure	Pad Order	Display
1	Press the DEFROST pad.	 x 2	
2	Press the START/+30SEC. pad.		
3	Enter the weight.		
4	Press the START/+30SEC. pad.		 The timer begins to count down. The oven will "beep" 4 times and will stop. TURN OVER STEAK/CHOPS PRESS START will be displayed repeatedly.
5	Open the door. Turn over the meat. Close the door.		TURN OVER STEAK/CHOPS PRESS START will be displayed repeatedly.
6	Press the START/+30SEC. pad.		 When the cooking time reaches zero, FINISH REMOVE FOOD will be displayed repeatedly.

Favourite

The favourite function allows you to store 3 frequently used microwave power levels and cook times to make cooking/reheating more convenient.

Example: Set the following procedure as Favourite 2.

Cook food for 3 minutes and 20 seconds at 880W.

Step	Procedure	Pad Order	Display
1	Press the FAVOURITE pad twice.	<div style="border: 1px solid black; padding: 5px; display: inline-block;">FAVOURITE</div> x 2	<div style="border: 1px solid black; padding: 2px; display: inline-block; margin-bottom: 2px;">2 PRESS</div> <div style="border: 1px solid black; padding: 2px; display: inline-block; margin-bottom: 2px;">START</div> <div style="border: 1px solid black; padding: 2px; display: inline-block; margin-bottom: 2px;">OR</div> <div style="border: 1px solid black; padding: 2px; display: inline-block; margin-bottom: 2px;">PRESS</div> <div style="border: 1px solid black; padding: 2px; display: inline-block; margin-bottom: 2px;">MICRO</div> <div style="border: 1px solid black; padding: 2px; display: inline-block; margin-bottom: 2px;">WATTAGE</div> <div style="border: 1px solid black; padding: 2px; display: inline-block; margin-bottom: 2px;">KEY TO</div> <div style="border: 1px solid black; padding: 2px; display: inline-block;">PROGRAM</div>



If the procedure has been set, press "START/ 30SEC." to use it. If not, continue to set the procedure. Only one or two stages can be set.

Step	Procedure	Pad Order	Display
2	Select desired power level by pressing the MICROWAVE WATTAGE pad.	<div style="border: 1px solid black; padding: 5px; display: inline-block;">MICROWAVE WATTAGE</div> x 3	<div style="border: 1px solid black; padding: 2px; display: inline-block; margin-bottom: 2px;">880 W</div> <div style="border: 1px solid black; padding: 2px; display: inline-block; margin-bottom: 2px;">PRESS</div> <div style="border: 1px solid black; padding: 2px; display: inline-block; margin-bottom: 2px;">AGAIN</div> <div style="border: 1px solid black; padding: 2px; display: inline-block; margin-bottom: 2px;">TO</div> <div style="border: 1px solid black; padding: 2px; display: inline-block; margin-bottom: 2px;">LOWER</div> <div style="border: 1px solid black; padding: 2px; display: inline-block; margin-bottom: 2px;">POWER</div> <div style="border: 1px solid black; padding: 2px; display: inline-block; margin-bottom: 2px;">OR PUSH</div> <div style="border: 1px solid black; padding: 2px; display: inline-block;">START</div>
3	Press the START/+30SEC. pad.	<div style="border: 1px solid black; padding: 5px; display: inline-block;">START +30SEC.</div>	<div style="border: 1px solid black; padding: 2px; display: inline-block; margin-bottom: 2px;">ENTER</div> <div style="border: 1px solid black; padding: 2px; display: inline-block; margin-bottom: 2px;">TIME</div> <div style="border: 1px solid black; padding: 2px; display: inline-block; margin-bottom: 2px;">PRESS</div> <div style="border: 1px solid black; padding: 2px; display: inline-block;">START</div>
4	Enter desired cooking time.	<div style="border: 1px solid black; padding: 2px; display: inline-block; margin-right: 5px;">3</div> <div style="border: 1px solid black; padding: 2px; display: inline-block; margin-right: 5px;">2</div> <div style="border: 1px solid black; padding: 2px; display: inline-block; border-radius: 50%;">○</div>	<div style="border: 1px solid black; padding: 2px; display: inline-block;">3:20</div>
5	Press the START/+30SEC. pad.	<div style="border: 1px solid black; padding: 5px; display: inline-block;">START +30SEC.</div>	<div style="border: 1px solid black; padding: 2px; display: inline-block; margin-bottom: 2px;">ENTER</div> <div style="border: 1px solid black; padding: 2px; display: inline-block; margin-bottom: 2px;">2ND</div> <div style="border: 1px solid black; padding: 2px; display: inline-block; margin-bottom: 2px;">MICRO</div> <div style="border: 1px solid black; padding: 2px; display: inline-block; margin-bottom: 2px;">WATTAGE</div> <div style="border: 1px solid black; padding: 2px; display: inline-block; margin-bottom: 2px;">OR PUSH</div> <div style="border: 1px solid black; padding: 2px; display: inline-block;">START</div> <div style="border: 1px solid black; padding: 2px; display: inline-block; margin-top: 10px;">TO END</div>
6	Press the START/+30SEC. pad to save as FAVOURITE 2 and to operate. To add another stage to the program repeat steps 2 to 5.	<div style="border: 1px solid black; padding: 5px; display: inline-block;">START +30SEC.</div>	

Child Lock

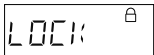

If the oven is accidentally started with no food or liquid in the cavity, the life of the oven can be reduced. To prevent accidents like this, your oven has a "Child Lock" feature that you can set when the oven is not in use.

* To set the Child Lock.

Step	Procedure	Pad Order	Display
1	Press the number 0 pad for 3 seconds.		
2	Press the START/+30SEC. pad.		 The time of day will be displayed.

The control panel is now locked, each time a pad is pressed, the display will show "LOCK".

* To cancel the Child Lock.

Step	Procedure	Pad Order	Display
3	Press the STOP/CLEAR pad for 3 seconds.		 The time of day will be displayed. The oven is ready to use.

CARE AND CLEANING

Disconnect the power supply cord before cleaning or leave the door open to inactivate the oven. Before cleaning ensure oven cavity is cool.

OVEN INTERIOR:

- It is important to clean the interior of your microwave oven after each use.
- To clean the oven interior, use a mild detergent solution, such as washing-up liquid, with warm water on a soft cloth.
- Heat up your oven regularly by using the grill. Remaining food or splatters can cause smoke or odours.
- Food and liquid splashes will build-up on the oven walls and ceiling. If grease, fat and food debris is allowed to build-up in the oven interior it may overheat, smoke or even catch fire when next using the oven.
- Keep the **waveguide cover** clean at all times. The waveguide cover is constructed from a fragile material and should be cleaned with care (follow the cleaning instructions above).

NOTE: Excessive soaking may cause disintegration of the waveguide cover. The waveguide cover is a consumable part and without regular cleaning, will need to be replaced.

- Food will release steam during cooking and cause condensation inside the oven and door. It is important to wipe the oven dry. A build-up of condensation will eventually lead to rust forming on the oven interior.
- Do not allow grease or dirt to build-up on the door seals or areas around the door. This may prevent the door from closing correctly and may cause a leakage of microwaves (follow the cleaning instructions below).
- Ensure the accessories are cleaned after every use with a mild washing-up liquid solution and dried. This will prevent the build-up of grease and food debris. The accessories are dishwasher safe.
- Clean the oven at regular intervals and remove any food deposits. Failure to maintain the oven in a clean condition could lead to a deterioration of the surface that could adversely affect the life of the appliance and possibly result in a hazardous situation.

OUTER CABINET:

- Wipe the outside of the microwave oven with a mild detergent solution, such as washing-up liquid, with warm water on a soft cloth.
- The control panel must be wiped clean and dried with the door open, therefore inactivating the oven.

DOOR:

- To remove all traces of dirt, regularly clean both sides of the door, the door seals and adjacent parts with a soft, damp cloth.
- Do not use harsh abrasive cleaners or sharp metal scrapers to clean the oven door glass since they can scratch the surface, which may result in shattering of the glass.

NOTES:

- Never use spray cleaners, oven pads or abrasive scourers as these damage the surface of the oven.
- A steam cleaner should not be used.
- Take care not to let soapy water drip through the small holes in the oven walls and the cavity floor. Excess water spillage through these holes will cause damage to the oven interior.
- Slight tarnishing of the oven cavity, around the area of the grills, is likely to occur. This is normal and will not affect the oven's performance.

Warning:

Before cleaning, make sure the oven cavity, door, oven cabinet, accessories and especially the grills are completely cool.

SERVICE CALL CHECK

Check the following before calling for a service:

- | | | |
|---|----------|---------|
| 1. Does the display light? | Yes_____ | No_____ |
| 2. When the door is opened, does the oven lamp come on? | Yes_____ | No_____ |
| 3. Place one cup of water (approx. 250 ml) in a glass measure in the oven and close the door securely. Press the START/+30SEC. pad. | | |
| A. Does the oven lamp light? | Yes_____ | No_____ |
| B. Does the cooling fan work?
(Put your hand over the rear ventilation openings.) | Yes_____ | No_____ |
| C. Does the turntable rotate?
(The turntable can rotate clockwise or counterclockwise. This is quite normal.) | Yes_____ | No_____ |
| D. Does the COOK indicator light? | Yes_____ | No_____ |
| E. After one minute, did an audible signal sound? | Yes_____ | No_____ |
| F. Is the water inside the oven hot? | Yes_____ | No_____ |
| 4. Remove water from the oven and program the oven for 3 minutes on GRILL mode. | | |
| A. Does the GRILL symbol and cook indicator light? | Yes_____ | No_____ |
| B. After 3 minutes, does the grill become red? | Yes_____ | No_____ |

If "NO" is the answer to any of the above questions, please check your wall socket and the fuse in your meter box. If both the wall socket and the fuse are functioning properly, CONTACT YOUR NEAREST SERVICE CENTRE APPROVED BY SHARP.

SPECIFICATIONS

AC Line Voltage	:	Single phase 230 - 240V, 50Hz.
AC Power Required	:	
Microwave	—	1300 W(Steady), 1800 W(Initial)
Grill	—	1130 W
Convection	—	2150 W
Output Power	:	
Microwave	—	1100 W* (IEC test procedure)
Grill	—	1100 W
Convection	—	2100 W

Microwave Frequency	:	2450 MHz (Class B/Group 2)**
Outside Dimensions	:	520 mm(W) x 315 mm(H) x 510 mm(D)
Cooking Uniformity	:	Turntable (315 mm in diameter) system
Weight	:	Approx. 15 kg

* When tested in accordance with AS/NZS 2895.1.2007

** This is the classification of ISM (Industrial, Scientific and Medical) equipment described in the International Standard CISPR11.

ROAST MEAT AND POULTRY CHART

1. Use the low rack.
2. Preheat oven according to the temperature in the PREHEAT TEMPERATURE column.
3. Season meat/poultry if desired and cover lightly with oil.
4. Turn meat/poultry over half way through cooking.

MEAT	COOKING TIME	PREHEAT TEMPERATURE	COOKING TEMPERATURE	STANDING TIME
Beef Roast	25-27 minutes/500g	200°C	200°C	15-25 minutes
Lamb Roast	25-27 minutes/500g	200°C	200°C	15-25 minutes
Pork Roast	30-32 minutes/500g	230°C	230°C	10-20 minutes
Roast Chicken	20-22 minutes/500g	220 °C	220 °C	5-10 minutes

*Maximum 2kg weight per roast.

** Times are an estimation only. You may have to adjust times and temperatures according to your preference.

FAN-FORCED CONVECTION CHART

FOOD	AMOUNT	COOKING FUNCTION	COOKING TIME	PROCEDURE
Cake	850g	Convection 180°C	55 minutes	Preheat to 180 °C. Bake cake in cake tin on the low rack.
Thin Chips	200g	Convection 230°C	35 minutes	Preheat to 230 °C. Use a baking tray. Place chips in a single layer. Turn over half way through cooking.
Thick Chips	200g	Convection 230°C	35 minutes	Preheat to 230 °C. Use a baking tray. Place chips in a single layer. Turn over half way through cooking.
Chicken Chips	250g	Convection 230°C	15 minutes	Preheat to 230 °C. Use a baking tray. Place chips in a single layer. Turn over half way through cooking.
Chicken Nuggets	12 nuggets	Convection 230°C	20 minutes	Preheat to 230 °C. Use a baking tray. Place nuggets in a single layer. Turn over half way through cooking.
Potato Wedges	250g	Convection 230°C	30 minutes	Preheat to 230 °C. Use a baking tray. Place wedges in a single layer. Turn over half way through cooking.
Roast Vegetables e.g. Potato, Sweet Potato, Pumpkin	500g	Convection 200°C	55 minutes	Preheat to 200 °C. Use a baking tray. Place vegetables in a single layer. Spray lightly with cooking oil and season to taste. Turn over half way through cooking.
Mini Pies	10 mini pies	Convection 220°C	25 minutes	Preheat to 220 °C. Use a baking tray. Place pies in a single layer. Turn over half way through cooking.
Mini Sausage Rolls	10 mini sausage rolls	Convection 220°C	25 minutes	Preheat to 220 °C. Use a baking tray. Place sausage rolls in a single layer. Turn over half way through cooking.
Frozen Lasagne	400g	Convection 200°C	50 minutes	Preheat to 200 °C. Use an oven safe dish. Do not cover.

REHEATING CONVENIENCE – FOOD CHART
DEFROSTING CONVENIENCE

FOOD	AMOUNT	COOKING TIME AND POWER LEVEL	PROCEDURE	STANDING TIME
Beverage (room temp.) 250mL per cup	1 cup 2 cups	2 minutes – 2 minutes 30 seconds on 880W 3-4 minutes on 880W	Stir after heating.	
Canned Food (room temp.) (e.g. Spaghetti, Baked Beans)	1 cup 2 cups	3-5 minutes on 550W 6-8 minutes on 550W	Place food in bowl. Cover with plastic wrap and pierce 5 times with a skewer. Stir halfway.	2 minutes
Canned Soup (room temp) 250mL per cup (thin soup)	1 cup 2 cups	3-4 minutes on 1100W 5-6 minutes on 1100W	Place food in bowl. Cover with plastic wrap or lid. Stir halfway.	2 minutes
Meat Pie (refrigerated) Individual 180g each	1 pie 4 pies	5-6 minutes on 550W 10-11 minutes on 550W	Place directly on turntable, face side down. Cover with paper towel. Turn over halfway.	2 minutes
Frozen Rice/Pasta Dinners (e.g. Lasange, Risotto)	300-500g	7-9 minutes on 1100W	Remove from foil container. Cover with plastic wrap or lid. Allow to stand	2 minutes
Pizza Slice (refrigerated) Slice 100g each	1 slice 2 slices	1 minute – 1 minute 30 seconds on 770W 1 minute 30 seconds – 2 minutes on 770W	Place on a sheet of paper towel. Place directly on the turntable.	
Dinner Plate (refrigerated) 350g-400g per serve	1 serve	3-5 minutes on 1100W	Slice potato. Cover plate with plastic wrap and pierce 5 times with a skewer. Place directly on turntable. Allow to stand.	2 minutes
Casserole (refrigerated) 250g per serve	1 serve 2 serves	5-6 minutes on 550W 7-9 minutes on 550W	Place in a bowl, cover with plastic wrap. Place directly on turntable. Stir halfway. Allow to stand, then stir.	2 minutes
Croissants (frozen)	1 2	1 minute on 330W 1 minute 30 seconds on 330W	Place between paper towels. Place directly on the turntable.	
Fruit Pie individual (frozen) 135g each	1 2	2-3 minutes on 330W 3-4 minutes on 330W	Remove from foil container. Place on a plate and then onto the turntable. Allow to stand.	2 minutes
Danish Pastry whole (frozen)	400g	5-6 minutes on 330W	Remove from foil container. Place on dinner plate. Allow to stand.	2 minutes

NOTE: Room Temperature +20°C
 Refrigerator Temperature +3°C
 Frozen Temperature -18°C

FROZEN VEGETABLE CHART

1. Place vegetables in a medium/large microwave safe bowl and cover with plastic wrap.
2. Halfway through cooking, stir the vegetables to ensure even cooking.
3. Allow to stand for 2 minutes before draining any water and serving.

VEGETABLE	AMOUNT	MICROWAVE TIME 1100W	PROCEDURE
Beans (green, cut)	500g	8-10 minutes	
Broccoli	500g	8-10 minutes	Break apart as soon as possible. Arrange with flower towards the centre.
Carrots (sliced)	500g	10-12 minutes	Stir halfway through.
Cauliflower	500g	8-10 minutes	Break apart as soon as possible. Arrange with flower towards the centre.
Corn on the Cob	4 pieces	8-10 minutes	
Peas (green)	500g	7-9 minutes	
Spinach	250g	6-7 minutes	Break apart as soon as possible.
Mixed Vegetables (i.e. carrots, beans and corn kernels)	500g	13-15 minutes	Break apart as soon as possible.

RICE AND PASTA COOKING CHART

1. Wash and strain rice before measuring amounts.
2. Place rice/pasta in a medium/large microwave safe bowl with water. Cook uncovered at 1100W, stirring halfway through cooking. Allow to stand for 2 minutes before straining any remaining water and serving.

FOOD	OTHER INGREDIENTS	MICROWAVE TIME 1100W	
Pasta	1 cup	2 cups hot water	15-17 minutes
	2 cups	4 cups hot water	18-20 minutes
	4 cups	6 cups hot water	19-21 minutes
White Rice	1 cup	2 cups hot water	15-17 minutes
	2 cups	4 cups hot water	18-20 minutes
	4 cups	6 cups hot water	25-27 minutes
Brown Rice	1 cup	2 cups hot water	26-28 minutes
	2 cups	4 cups hot water	34-36 minutes
	4 cups	6 cups hot water	49-51 minutes
Quick Oats	1 cup	2 ¼ cups milk	5-6 minutes

GUIDE TO COOKING EGGS

Place butter, eggs and milk in a small/medium microwave safe bowl. Beat with a fork until well combined and yolks of eggs are completely stirred in. Cook uncovered, stirring halfway through cooking.

EGG(S)	BUTTER	MILK	MICROWAVE TIME 770W
1	1 tsp	1 tbsp	1 minute
2	2 tsp	1 tbsp	2 minutes
3	1 tbsp	2 tbsp	3 minutes
4	1 tbsp	¼ cup	4 minutes

FRESH VEGETABLE CHART

1. Wash vegetables under cold running water.
2. Cover required dishes with plastic wrap or a lid.
3. Drain any remaining water after standing before serving.

VEGETABLE	AMOUNT	MICROWAVE TIME 1100W	PROCEDURE
Asparagus	500g	3-5 minutes	Place in a microwave safe dish. Cover. Stand for 2 minutes.
Beans (top and tailed)	500g	5-6 minutes	Place in a microwave safe dish with 1 tablespoon of water. Cover. Stand for 2 minutes.
Broccoli (uniform florets)	500g	4-6 minutes	Place in a microwave safe dish. Cover. Stand for 2 minutes.
Brussels Sprouts	500g	4-6 minutes	Place in a microwave safe dish. Cover. Stand for 2 minutes.
Cabbage (shredded)	500g	6-8 minutes	Place in a microwave safe dish with 2 tablespoons of water. Cover. Stand for 2 minutes.
Carrots (sliced)	500g	5-7 minutes	Place in a microwave safe dish. Cover. Stand for 2 minutes (cook for longer for less crunch).
Cauliflower (uniform florets)	500g	4-6 minutes	Place in a microwave safe dish with 1 tablespoon of water. Cover. Stand for 2 minutes.
Corn on the Cob	2 pieces	6-8 minutes	Rinse corn under cold water. Place corn in husk and place directly on the turntable. Turn over during cooking. Stand for 2 minutes.
Mushrooms (quartered)	500g	4-6 minutes	Place in a microwave safe dish with 1 tablespoon of water. Cover. Stand for 2 minutes.
Potatoes – Jacket	4 medium	12-13 minutes	Pierce with a fork. Turn over during cooking. Stand for 2 minutes.
Potatoes – Boiled	4 medium	14-16 minutes	Peel and quarter potatoes. Cook in a dish with $\frac{1}{3}$ cup water. Cover. Stand for 2 minutes.
Pumpkin (2cm cubes)	500g	8-10 minutes	Place in a microwave safe dish. Cover. Stand for 2 minutes.
Spinach (shredded)	500g	3-4 minutes	Place in a microwave safe dish with 2 tablespoons of water. Cover. Stand for 2 minutes.
Snow Peas (top and tailed)	500g	3-5 minutes	Place in a microwave safe dish with 1 tablespoon of water. Cover. Stand for 2 minutes (cook for longer for less crunch).
Sweet Potato (2cm cubes)	500g	6-8 minutes	Place in a microwave safe dish. Cover. Stand for 2 minutes.
Zucchini (sliced)	500g	4-6 minutes	Place in a microwave safe dish with 1 tablespoon of water. Cover. Stand for 2 minutes.

CHARTS

DEFROST TIMES FOR MEAT, POULTRY, BREAD AND PIES

1. Remove wrapping and place frozen item on a shallow, Microwave safe plastic defrost rack. If necessary, shield thin areas with aluminum foil to prevent the item from cooking while defrosting.
2. Defrost by following the steps in the MICROWAVE TIME column.
3. Set the microwave to 330W.
4. When turning over, re-shield any warm areas so it continues to defrost without cooking.

CUT	MICROWAVE TIME	STANDING TIME
BEEF (Roast)	5-7 minutes/500g	10-15 minutes
Steaks	3-5 minutes/500g	10 minutes
Minced Beef	3-5 minutes/500g	10 minutes
PORK (Roast)	5-7 minutes/500g	10-15 minutes
Chops	3-5 minutes/500g	10 minutes
Ribs	5-6 minutes/500g	10 minutes
Minced Pork	5-6 minutes/500g	10 minutes
LAMB (Roast)	5-7 minutes/500g	10-15 minutes
Chops	3-5 minutes/500g	10 minutes
POULTRY		
Chicken (Whole)	7-9 minutes/500g	10-15 minutes
Pieces	6-8 minutes/500g	10 minutes

BREAD / PIES	MICROWAVE TIME	PROCEDURE
2 Slices of Bread	30 seconds	Place between paper towel and place directly on the turntable.
4 Slices of Bread	1 minute–1 minute 30 seconds	
1 Bread Roll	30 second –1 minute	
2 Bread Rolls	2 minutes	
Individual Pie	3 minutes	Remove from packaging. Place between paper towel and place directly on the turntable. Turn over halfway. Allow to stand 3-5 minutes before reheating.

APRICOT WHEATGERM CRUNCHIES

Makes 18

125 g butter
3/4 cup brown sugar, lightly packed
1/2 teaspoon vanilla essence
1 egg
1/2 cup self-raising flour, sifted
3/4 cup wheatgerm
1/3 cup desiccated coconut
1/3 cup rolled oats
125 g dried apricots, chopped
1 1/2 cups cornflakes

1. Preheat oven to 200°C.
 2. Cream butter and sugar together until light and fluffy. Add vanilla and egg. Beat well.
 3. Mix in flour, wheatgerm, coconut, rolled oats, apricots and cornflakes.
 4. Shape tablespoonfuls of mixture into balls.
 5. Place on a greased pizza tray: flatten slightly with a fork.
 6. Place on the low rack. Bake for 12-14 minutes on CONVECTION 200°C.
- NOTE: Cook in the two batches.

CHOCOLATE CHIP COOKIES

Makes 24

125 g butter
1/2 cup caster sugar
1/2 cup brown sugar, lightly packed
1/2 teaspoon vanilla essence
1 egg
1 3/4 cups self-raising flour, sifted
1/2 teaspoon salt
125 g choc bits
60 g walnut pieces

1. Preheat oven to 200°C.
 2. Cream butter, sugars and vanilla until light and fluffy. Beat in egg.
 3. Mix in flour, salt, choc bits and walnut pieces.
 4. Shape tablespoonfuls of mixture into balls. Place on a lightly greased pizza tray: press down slightly, allowing room for spreading.
 5. Place on the low rack. Bake for 12-14 minutes on CONVECTION 200°C.
- NOTE: Cook in the two batches.

MUESLI CUSTARD DELIGHT

Serves 6-8

300 g carton, sour cream
3 x 410 g can, sliced peaches, drained
1 cup butter cake mix
2 cups toasted muesli
1/2 cup coconut
175 g butter, melted

1. Spread sour cream evenly over base of a 20 cm glass pie plate. Sprinkle with drained peaches.
2. Combine butter cake mix, muesli, coconut and butter in a small bowl. Mix well.
3. Spread muesli mixture over peaches.
4. Cook on the low rack for 6 minutes on 1100W and 4 minutes on GRILL.
5. Stand 5 minutes before serving.

CHOCOLATE SELF-SAUCING PUDDING

Serves 4-6

60 g butter
1½ cups self-raising flour
½ cup caster sugar
¼ cup cocoa powder
¾ cup milk
1 teaspoon vanilla essence
1 cup brown sugar
⅓ cup cocoa powder, extra
2 cups boiling water

1. Place butter in a large microwave safe pudding bowl; melt for 40 seconds on 1100W.
2. Stir in flour, sugar, cocoa, milk and vanilla. Beat until smooth.
3. Combine brown sugar and extra cocoa and boiling water. Pour over pudding mixture.
4. Cook for 12 minutes on 1100W. Allow to stand for 5 minutes before serving.
5. Serve hot with ice-cream.

BREAD AND BUTTER PUDDING

Serves 4-6

6 slices multigrain bread, crusts removed
butter
3 tablespoons caster sugar
¼ cup sultanas
2 cups milk
½ teaspoon vanilla essence
3 eggs, lightly beaten
3 tablespoons brown sugar
¼ teaspoon nutmeg

1. Spread bread with butter and cut into 2 cm cubes.
2. Place bread, sugar and sultanas in a 2 litre pudding bowl.
3. Heat milk and vanilla in a small microwave safe bowl for 3 minutes on 1100W. Gradually whisk into eggs, then pour over bread mixture.
4. Sprinkle with brown sugar and nutmeg.
5. Cook for 25-28 minutes on 330W.
6. Allow to stand for 5 minutes before serving.

CARAMEL RICE PUDDING

Serves 4-6

1 cup arborio rice
3 cups water
395 g can condensed milk
20 g butter
1 tablespoon lemon juice
3 eggs, separated
1 tablespoon vanilla essence
2 tablespoons caster sugar
cinnamon sugar

1. Place rice and water in a large microwave safe glass bowl. Cook for 12-15 minutes on 1100W, or until tender. Stir at halfway. Drain.
2. Mix condensed milk and butter together. Cook for 4-6 minutes on 1100W, stirring every 20 seconds. (Caramel will boil over if not stirred.)
3. Stir cooked rice, lemon juice, egg yolks and vanilla essence into caramel. Pour into a 2-litre pudding bowl.
4. Beat egg whites until stiff, gradually beat in sugar. Spoon over rice pudding.
5. Sprinkle with cinnamon sugar. Cook for 3-5 minutes on 550W and 3 minutes on GRILL.
6. Stand 5 minutes before serving.

CHOCOLATE MOUSSE

Serves 4

200 g cooking chocolate
2 tablespoons water
2 tablespoons rum
¼ cup caster sugar
3 egg whites
300 mL carton thickened cream
extra cream for decoration
30 g chocolate, grated

1. Place chocolate, water and rum in a large microwave safe bowl. Melt for 30 seconds-1 minute on 1100W. Stir in sugar.
2. Allow mixture to cool, then whip until aerated.
3. Beat egg whites until stiff peaks form.
4. Whip the cream until thick but not stiff. Fold cream and beaten egg whites into chocolate mixture.
5. Divide mixture evenly between four dessert glasses. Refrigerate until set.
6. Serve decorated with cream and chocolate shavings.

DESSERTS

CALIFORNIAN APPLE CRUNCH

Serves 6-8

800 g can pie apple
1½ cups White Wings buttercake mix
125 g hard butter, cut into thin slices
3 tablespoons brown sugar
3 tablespoons coconut
2 tablespoons crushed nuts
1 teaspoon cinnamon

1. Place pie apple in a shallow casserole dish.
2. Sprinkle evenly with dry cake mix.
3. Layer sliced butter over cake mix, covering completely.
4. Combine last 4 ingredients and sprinkle over sliced butter.
5. Cook for 6 minutes on 1100W and 3½ minutes on GRILL.
6. Serve warm with whipped cream.

AUSTRALIAN FRUIT CAKE

Serves 4-6

1 kg mixed fruit	1 cup plain flour, sifted
1 cup brown sugar	1 teaspoon baking powder
250 g butter, chopped	salt
2 tablespoons brandy	½ teaspoon nutmeg
4 eggs, lightly beaten	1 teaspoon cinnamon
2 teaspoons parisienne essence	2 tablespoons brandy, extra

1. Preheat oven to 180°C.
2. Combine the first 4 ingredients in a large microwave safe bowl. Cover and cook for 5 minutes on 1100W, stirring once. Allow to cool slightly.
3. Stir in eggs and parisienne essence, followed by dry ingredients.
4. Pour into a greased 20cm square cake tin.
5. Cook for 55 minutes on CONVECTION 180°C.
6. Using a 3 cm foil strip, place around the outside of cake container at halfway of cooking time. (This will prevent the outside from overcooking before the centre is cooked.)
7. Stand covered for 15 minutes before turning out.
8. Pour over extra brandy. Decorate with extra glacé fruits if desired.

BAKED APPLES

Serves 4

¾ cup walnuts	4 large apples
¼ cup brown sugar	2 tablespoons lemon juice
2 teaspoons mixed spice	30 g butter, melted

1. Place walnuts, sugar and mixed spice in a blender or food processor, process until nuts are finely chopped.
2. Peel and core apples, brush with lemon juice.
3. Brush apples with butter. Toss in walnut mixture until evenly coated.
4. Place in base of a 20 cm glass pie plate. Fill centre of apples with any remaining walnut mixture.
5. Cook for 4-6 minutes on 1100W and 6-8 minutes on GRILL. Allow to stand for 5 minutes.
6. Serve with whipped cream.

CHOCOLATE CAKE

175 g Nestlé Milk Choc Melts	2 eggs, lightly beaten
100 g butter	2½ cups self-raising flour, sifted
125 mL (½ cup) sour cream	1 cup brown sugar
1¼ cups warm water	½ teaspoon baking powder

ICING

250 g chocolate
2 tablespoons black coffee
50 mL sour cream

1. Place chocolate and butter in a large microwave safe bowl. Melt for 1-1½ minutes on 1100W, stirring during cooking.
2. Add sour cream and water. Cook a further 1 minute on 1100W. Mix well.
3. Stir in eggs, flour, sugar and baking powder.
4. Mix well, pour into a greased microwave safe cake container.
5. Cook for 13 minutes on 550W followed by 13 minutes on CONVECTION 130°C. Allow to stand 10 minutes before turning out.
6. Allow to cool before icing.

ICING

1. Melt chocolate and coffee for 1-2 minutes on 1100W.
2. Add sour cream and beat well.

POTATOES PIZZAIOLA

Serves 4-6

4 large potatoes
20 g butter
1 clove garlic, crushed
400 g can tomatoes, roughly chopped
2 teaspoons fresh (or 1/2 teaspoon dried) oregano
ground black pepper

1. Peel and dice potatoes into 1.5 cm cubes, rinse and place in a large microwave safe bowl with 2 tablespoons of water, cover and cook for 8 minutes on 1100W, stirring halfway through cooking. Drain.
2. In a small microwave safe bowl, combine butter and garlic and cook for 50 seconds on 1100W.
3. Combine oregano and pepper to garlic mixture.
4. Add tomatoes and garlic mixture to potatoes, ensuring potatoes are well coated.
5. Cook, uncovered, for 10 minutes on 1100W, stirring halfway through cooking.

GRILLED TOMATOES

Serves 4

2 tomatoes

1. Cut tomatoes in half.
2. Place directly onto turntable.
3. Cook for 5 minutes on GRILL.
4. Turn over, cook for 5 minutes on GRILL.

SOY AND SESAME GREEN BEANS

Serves 4

300 g green beans
1 tablespoon soy sauce
1 tablespoon olive oil
sesame seeds, to garnish

1. Cut the ends off beans and rinse well.
2. Place beans in a large square casserole dish. Pour soy sauce and oil and toss well.
3. Cook on the high rack for 12 minutes on COMBI C3, mixing halfway through.
4. Sprinkle with sesame seeds.

PUMPKIN SALAD

Serves 6-8

1 kg pumpkin, peeled and cubed
3/4 cup walnuts
6 shallots, chopped
1/4 cup finely chopped parsley
1/2 teaspoon nutmeg
ground black pepper
1 cup mayonnaise

1. Place pumpkin in large microwave safe bowl, add 2 tablespoons of water, cover and cook for 12-14 minutes on 1100W or until pumpkin is just cooked, but still firm.
2. Refresh by running cold water over pumpkin. Drain and chill.
3. Mix walnuts, shallots, parsley, nutmeg and pepper with mayonnaise.
4. Fold mayonnaise mixture gently into the pumpkin. Serve chilled.

ROAST VEGETABLES

Serves 4

300 g baby potatoes, cut in half
300 g sweet potatoes, peeled
250 g parsnips, peeled
2 tablespoon olive oil
1 teaspoon oregano
1 teaspoon parsley
pinch of salt

1. Cut sweet potato lengthwise and into 2 cm chunks. Cut parsnips into quarters.
2. Add potatoes, sweet potatoes and parsnips into a large shallow square casserole dish. Cook, covered for 8-10 minutes on 1100W, drain.
3. Combine oil, oregano, parsley and salt. Pour over vegetables, coat evenly.
4. Cook, uncovered for 26 minutes on COMBI C3, mixing half way through.

SQUASH WITH YOGHURT

Serves 4-6

500 g squash
200 g carton natural yoghurt
2 teaspoons seeded mustard
ground black pepper

1. Wash and trim squash. Slice thinly, place in a microwave safe glass pie plate.
2. Cover and cook for 4-6 minutes on 1100W, or until just tender. Drain juice prior to adding yoghurt.
3. Combine yoghurt, mustard and pepper and gently fold through the squash.
4. Serve hot.

HONEY GINGERED VEGETABLES

Serves 6

1/2 cup salad dressing
2 teaspoons grated ginger
2 tablespoons honey
1 tablespoon soy sauce
2 tablespoons lemon juice
500 g butternut pumpkin, peeled and thinly sliced
1 cup frozen beans
2 zucchinis, sliced
1/2 cup pecans

1. In a large microwave safe bowl, heat dressing, ginger, honey, soy sauce and lemon juice for 3-4 minutes on 1100W.
2. Add pumpkin and cook covered 4-6 minutes on 1100W, until just tender.
3. Stir in beans and zucchinis, cook covered a further 6-7 minutes on 1100W.
4. Spoon onto a serving plate. Sprinkle with pecans.

GRILLED ZUCCHINI WITH FETA AND MINT

Serves 2

300 g zucchini
approximately 100 g feta
olive oil, to brush
handful of fresh mint finely chopped

1. Cut zucchini in half, and then cut lengthwise to make 4 slices.
2. Brush each side of the zucchini with olive oil.
3. Arrange zucchini on the high rack in a circle. Cook for 20 minutes on GRILL, turning half way through.
4. Place zucchini in a bowl. Add crumbled feta and garnish with fresh mint.

POTATO, AVOCADO AND ONION SALAD Serves 6

1 kg small new potatoes
1 large onion, sliced into rings
1 tablespoon caster sugar
20 g butter
1/2 cup mayonnaise
150 mL sour cream
black pepper
1 large avocado, cubed
chives, to garnish

1. Cut unpeeled potatoes in half. Place in a large microwave safe bowl and cover with water. Cook, covered with a lid, for 18-20 minutes on 1100W (potatoes should be tender but holding their shape). Drain.
2. Place onion rings, caster sugar and butter in a microwave safe glass bowl. Cook for 4-5 minutes on 1100W, stirring halfway through.
3. Combine mayonnaise, sour cream and black pepper. Pour over potatoes.
4. Toss in onions and avocado; sprinkle with chives.
5. Chill serve.

STUFFED MUSHROOMS Serves 4

2 slices white bread	1 tablespoon Worcestershire sauce
2 rashers bacon, chopped	1 tablespoon chopped fresh parsley
2 shallots, finely chopped	6 large flat mushrooms, stalks removed (approx. 80g each)
1/2 cup grated cheddar cheese	20 g butter
1 tablespoon grated parmesan cheese	

1. Process the bread into fine crumbs. Set aside.
2. Place the bacon between sheets of paper towel. Cook for 2 minutes on 1100W.
3. Place the shallots and bacon in a small microwave safe glass bowl. Cook for 1 minute on 1100W.
4. Mix the breadcrumbs, bacon, shallot, cheeses, Worcestershire sauce and parsley until well combined.
5. Spoon the mixture into the mushrooms.
6. Cut the butter into 6 equal cubes and place on each mushroom.
7. Place the filled mushrooms on the high rack. Cook for 15 minutes on Convection 200°C.

CHUNKY VEGETABLE SOUP Serves 6

1/2 cup oil	2 zucchinis, chopped
60 g butter	1/4 cabbage, shredded
2 onions, peeled and chopped	3 cups beef stock
3 carrots, finely chopped	2 x 400 g cans peeled tomatoes
1 potato, peeled and chopped	salt and pepper
3 sticks celery, chopped	parmesan cheese

1. Combine oil, butter and onion in a large casserole dish. Cook for 2-3 minutes on 1100W.
2. Add carrots and potato. Cover and cook for 5 minutes on 1100W.
3. Add celery, zucchini and cabbage. Cover and cook for 3 minutes on 1100W. Add stock, undrained tomatoes, salt and pepper. Cook, covered, for 20-25 minutes on 1100W, stirring occasionally.
4. Serve hot, topped with parmesan cheese.

STUFFED BAKED POTATOES Serves 4

4 large potatoes
1/4 cup milk
1/4 cup cream
1/2 cup grated cheddar cheese
30 g butter
2 teaspoons dried parsley flakes
1/4 teaspoon dry mustard
paprika

1. Pierce potatoes with a fork; place on turntable. Cook for 10-12 minutes on 1100W. Stand in foil for 5 minutes.
2. Cut a thin slice from top of each potato; scoop out cooked potato with a spoon, leaving a thin shell.
3. Stir milk, cream, half the cheese, butter, parsley, mustard and potato. Mix well until no lumps remain.
4. Spoon mixture into each potato shell. Place on the low rack.
5. Sprinkle with remaining cheese and paprika. Cook for 2-3 minutes on 1100W and 8 minutes on GRILL.

VEGETABLES

CAULIFLOWER AU GRATIN

Serves 4-6

500 g cauliflower florets
30 g butter
2 tablespoons flour
1 cup milk
1 teaspoon mustard
1/2 cup grated cheese
paprika

1. Place cauliflower in a glass pie dish. Cover and cook on the low rack for 4-6 minutes on 1100W, until tender. Drain.
2. Melt butter in a microwave safe glass jug for 40-50 seconds on 1100W.
3. Stir in flour. Cook for 1 minute on 1100W.
4. Gradually stir in milk and mustard. Cook for 2-2 1/2 minutes on 1100W, stirring every minute.
5. Stir in cheese until melted.
6. Pour over cauliflower. Sprinkle with paprika.
7. Cook for 6-8 minutes on GRILL.

EASY HOME-MADE RICE RISOTTO

Serves 6-8

1 onion, diced
60 g butter
4 rashers bacon, diced (optional)
(or 1 cup cooked chicken or ham)
3 chicken or beef stock cubes
2 cups boiling water
1 cup long-grain rice, well washed
1 cup assorted finely chopped vegetables,
e.g. carrots, zucchinis, mushrooms

1. Place onion, butter and bacon in large casserole dish. Cook for 3-4 minutes on 1100W. Stir well.
2. Dissolve stock cubes in boiling water; add to onion and bacon. Add all other ingredients. Cover with a lid and cook for 16-18 minutes on 1100W. Do not stir while cooking.
3. At the end of this time, all the liquid will have been absorbed.
4. Leave to stand for 5 minutes and stir with a fork before serving.

SCALLOPED POTATOES

Serves 4-6

3 large potatoes (approx. 500 g), peeled and sliced thinly
1/4 cup water
1 large onion, sliced
200 g carton light sour cream
1 egg
90 g cheddar cheese, finely grated
paprika

1. Place potatoes in a round or oval shallow dish, add water, cover, and cook for 6-8 minutes on 1100W.
2. Drain off water.
3. Arrange sliced onion over potatoes.
4. Combine sour cream and egg. Mix well and pour over potatoes. Sprinkle with cheese and a little paprika if desired.
5. Cook uncovered, using the low rack on COMBI C3 for 15-17 minutes.

HONEY CARROTS

Serves 4

500 g carrots, sliced lengthwise
60 g butter
1 tablespoon honey

1. Combine all ingredients in a casserole dish.
2. Cover and cook for 6-8 minutes on 1100W.
3. Stand covered for 3 minutes before serving.

VEGETABLE PLATTER

Serves 4

200 g carrots, sliced
200 g broccoli, cut into florets
100 g zucchinis, sliced

1. Arrange vegetables in a glass pie dish with the harder vegetables positioned around the outside and the softer vegetables in the centre.
2. Cover with plastic wrap.
3. Cook for 4 1/2-5 1/2 minutes on 1100W.
4. Stand covered for 3 minutes before serving.

OYSTERS KILPATRICK

Serves 1-2

3 rashers bacon, chopped
1 dozen oysters in the half shell
2 tablespoons worcestershire sauce

1. Place bacon in a small microwave safe bowl, cover and cook for 3 minutes on 1100W.
2. Sprinkle bacon over top of oysters, and add sauce. Place on the high rack and cook for 8-10 minutes on GRILL.

PRAWN CUTLETS

Serves 4

16 green king prawns
1/2 cup breadcrumbs
1/4 cup plain flour
1 egg (lightly beaten)
2 tablespoons olive oil

1. Peel prawns, leaving tails intact and devein.
2. Cut prawn down the back, flatten slightly with hand to form a cutlet shape.
3. Dust prawns lightly with flour, dip into egg, and coat with breadcrumbs.
4. Line the high rack with foil and spray with non-stick spray.
5. Place prawns onto the high rack and cook for 5 minutes on COMBI C3.
6. Turn prawns over and cook for a further 5 minutes on COMBI C3.
7. Serve with tartare sauce.

SQUID IN TOMATO AND WINE SAUCE Serves 6

500 g squid tubes
1 tablespoon soy sauce
1 tablespoon cornflour
1 tablespoon olive oil
1 shallot, chopped
1 clove garlic, crushed
400 g can tomato, diced
1/4 cup dry white wine
2 tablespoons tomato paste
1 tablespoon chopped fresh basil

1. Cut squid tubes into rings. Sprinkle with combined soy sauce and cornflour. Refrigerate for 30 minutes.
2. Combine oil, onion and garlic in a large microwave safe bowl. Cook for 1 minute on 1100W.
3. Stir in tomatoes, white wine and tomato paste. Cook for 5-6 minutes on 1100W.
4. Stir in squid. Cook for 10-12 minutes on 550W, tossing every minute until squid is firm.
5. Sprinkle with fresh basil.
6. Serve with French bread and tossed salad.

BOUILLABAISSE Serves 8

6 mussels
750 g scallops
500 g green prawns,
peeled and deveined
500 g firm fish fillets,
cut into bite-size pieces
5 crab sticks, sliced
6 oysters
1 tablespoon olive oil
1 onion, finely chopped
1 clove garlic, crushed
1 1/2 cups fish stock
425 g can tomatoes, puréed
1/2 cup white wine
2 tablespoons tomato paste
1/4 teaspoon turmeric
grated rind of 1 lemon
salt and pepper
1/4 cup chopped fresh basil

1. Wash and clean seafood.
2. Cook oil, onion and garlic in a large casserole dish for 1-2 minutes on 1100W
3. Stir in fish stock, tomatoes, white wine and tomato paste. Cover and cook for 8 minutes on 1100W, stirring halfway through cooking.
4. Place mussels into hot stock, cover and simmer for 8-10 minutes on 770W or until mussels open. Discard any which stay closed.
5. Stir in scallops, prawns, turmeric, lemon rind, salt and pepper. Cover and cook for 5-6 minutes on 770W.
6. Stir in fish fillets, crab sticks and oysters. Cover and cook for 14-16 minutes on 770W or until fish flakes.
7. Garnish with fresh basil.

CURRIED SCALLOPS Serves 4

40 g butter
1 onion, finely chopped
1/2 teaspoon ground cumin
1/2 teaspoon ground coriander
1/2 teaspoon ground turmeric
1/2 lemon, juiced
1/4 cup cream
500 g scallops
1 tablespoon fresh coriander

1. In a large microwave safe glass bowl, combine the butter, onion, cumin, ground coriander, turmeric and lemon juice. Cover and cook for 5-6 minutes on 1100W.
2. Stir in the cream, blending well.
3. Add the scallops. Cook for 8-10 minutes on 550W, stirring every 2 minutes.
4. Serve with rice and garnish with fresh coriander.

SEAFOOD LASAGNE

Serves 6-8

125 g butter
1½ cups plain flour
1 teaspoon dry mustard
4 cups milk
500 g seafood marinara
1 packet fresh lasagne sheets
1½ cups grated tasty cheese

1. Melt butter in a large microwave safe bowl for 1-2 minutes on 1100W.
2. Stir in flour and dry mustard. Cook for 1½ minutes on 1100W.
3. Gradually stir in milk. Cook for 6-8 minutes on 1100W or until sauce is thick. Stir every 2 minutes.
4. Stir in marinara. Cook for 4-6 minutes on 550W.
5. Layer sheets over base of a 2 litre square casserole dish.
6. Cover noodles with ⅓ marinara sauce and ½ cup cheese. Repeat process, ending with marinara sauce and cheese.
7. Cook for 16-19 minutes on COMBI C3 and 3 minutes on GRILL.
8. Allow to stand for 10 minutes before serving.

SESAME PRAWNS

Serves 4

24 green king prawns (approx. 1 kg)
1 clove garlic
1 tablespoon ketjap manis
2 teaspoons sesame oil
1 tablespoon sesame seeds
6 bamboo skewers

1. Peel prawns, leaving tails intact, and devein. Place in a shallow dish.
2. Combine garlic, ketjap manis, sesame oil and sesame seeds. Pour over prawns. Cover and refrigerate for 1-2 hours.
3. Thread 3-4 prawns onto each bamboo skewer. Coat in sesame seeds.
4. Place skewers on the high rack. Cook for 15-17 minutes on GRILL. Turn over halfway.
5. Serve with satay sauce and rice.

CRAB MORNAVY

Serves 6

60 g butter
⅓ cup plain flour
½ teaspoon dry mustard
2 cups milk
1 onion, finely chopped
2 x 170 g cans crab meat, drained
salt and pepper
½ cup finely grated cheese
2 tablespoons cornflake crumbs

1. In a large microwave safe bowl, melt butter for 1-1½ minutes on 1100W. Stir in flour and mustard. Cook for a further 1 minute on 1100W.
2. Gradually stir in milk. Cook for 4-5 minutes on 1100W, stirring every 2 minutes.
3. Stir in onion, crab meat, salt and pepper and ¼ cup cheese.
4. Place into a 1 litre serving dish. Sprinkle with cornflake crumbs and remaining cheese.
5. Cook for 13-15 minutes on GRILL.
6. Serve with fresh garden salad.

GARLIC MUSSELS

Serves 4 as entree

500 g mussels
1 cup wine
2 cups water
1 clove garlic, crushed

GARLIC BUTTER
40 g butter
2 tablespoons olive oil
2 cloves garlic, crushed
pepper

1. Wash mussels under running water; remove all traces of mud, seaweed and barnacles with brush or knife; remove beards. Discard cracked, broken or open mussel shells.
2. In a large microwave safe bowl, cover mussels with wine, water and garlic. Cook for 16-18 minutes on 550W or until open, removing from liquid as they open. Discard unopened mussels.

GARLIC BUTTER

1. Melt butter in a microwave safe jug for 30 seconds on 1100W, add oil, garlic and pepper. Pour ½ garlic sauce over mussels; toss well.
2. Arrange mussels in serving bowl and pour remaining sauce over mussels.

SCALLOPS IN BLACK BEAN SAUCE Serves 4

1 tablespoon oil
2 spring onions, finely sliced
1 chilli, seeded and finely chopped
1 tablespoon cornflour

2 teaspoons sugar
1 tablespoon soy sauce
2 tablespoons black bean sauce
500 g scallops

1. In a large microwave safe bowl combine oil, onions and chilli; cook for 1 minute on 1100W.
2. Stir in cornflour, sugar, soy sauce and black bean sauce.
3. Add scallops; stir well.
4. Cook for 10-12 minutes on 550W, stirring twice during cooking.

CRISPY MARINATED CRAB STICKS Makes 24

12 crab sticks
2 tablespoons lemon juice
1 clove garlic, crushed
2 teaspoons grated ginger

1 teaspoon sugar
1/4 cup oil
1 tablespoon soy sauce
8 rashers bacon, rind removed

1. Cut crab sticks in half.
2. Place lemon juice, garlic, ginger, sugar, oil and soy sauce in a bowl. Mix well.
3. Place crab sticks in marinade and allow to stand 2 hours. Drain.
4. Cut bacon into 3 pieces. Wrap each piece around each crab stick; secure with a toothpick.
5. Place on the low rack.
6. Cook for 14-16 minutes on COMBI C3.
7. Cook for 1 1/2 minutes on GRILL.

TAGLIATELLE AND CRAB SALAD Serves 6-8

500 g tagliatelle pasta
12 crab sticks, sliced
1/2 cup toasted pine nuts
6 shallots, chopped

1/2 cup French dressing
300 mL cream
salt and pepper

1. Place tagliatelle into a large microwave safe bowl. Cover with hot tap water. Cook for 14-16 minutes on 1100W, until tender. Drain well.
2. Toss sliced crab sticks, pine nuts and shallots through pasta.
3. Mix French dressing and cream. Season with salt and pepper. Pour over pasta. Toss well.

PRAWN CREOLE Serves 4

20 g butter
1 medium onion, chopped
1 capsicum, chopped
1 stick celery, sliced
2 tablespoons flour
400 g can whole tomatoes
1/2 cup tomato paste

1 cup chicken stock
1 tablespoon parsley
2 teaspoons sugar
1/2 teaspoon salt
1/2 teaspoon chilli powder
500 g green prawns, peeled and deveined

1. In a large microwave safe bowl, combine butter, onion, capsicum and celery. Cook for 4-5 minutes on 1100W.
2. Stir in flour, tomatoes, tomato paste, chicken stock, parsley, sugar, salt and chilli powder; mix well.
3. Cook, uncovered, for 5 minutes on 1100W, stirring once.
4. Add prawns and cook for 18-20 minutes on 550W, stirring twice. Serve with rice.

SEAFOOD

MARINATED BABY OCTOPUS

Serves 2

400 g baby octopus
2 tablespoons balsamic vinegar
1 clove garlic, crushed
2 tablespoons chopped fresh coriander
1 fresh chilli seeded and chopped
extra coriander, to garnish
lime wedges, to serve

1. Rinse the octopus thoroughly, making sure the heads are clean. Large pieces of octopus should be cut into smaller pieces to ensure even cooking.
2. In a large bowl, combine balsamic vinegar, garlic, coriander and chilli.
3. Transfer the rinsed octopus to the bowl containing the sauces. Cover and refrigerate for at least 2 hours, or overnight.
4. Arrange the marinated octopus in a shallow microwave safe glass dish. Place on the high rack. Cook for 16-18 minutes on COMBI C3, turning half way through; a shorter or longer cooking time may be necessary depending on your preference of texture.
5. Garnish with the coriander leaves and serve with the lime wedges or salad greens.

CHEESY SALMON CANNELLONI

Serves 4-6

ROLLS

120 g cannelloni
250 g ricotta cheese
90 g cheddar cheese, grated
salt and pepper to taste
2 eggs, lightly beaten
210 g can red salmon, drained
2 teaspoons lemon juice
2 tablespoons cheddar cheese, extra

1. Combine ricotta cheese, cheddar cheese, salt and pepper, eggs, salmon and lemon juice; mix well.
2. Place a spoonful of salmon mixture into each cannelloni. Place in a single layer in a shallow heat-proof dish.

SAUCE

1. Combine cornflour with 2 tablespoons of tomato purée to form a smooth paste. Stir in remaining purée and parsley.
2. Pour tomato purée over salmon rolls and cook covered for 16-18 minutes on 770W or until cannelloni is tender.
3. Sprinkle the extra cheese over the pasta. Cover and cook for 2-3 minutes on 770W.

GARLIC PRAWNS

Serves 4

24 green king prawns
40 g butter
3 cloves garlic, crushed
1/3 cup olive oil
1 tablespoon chopped parsley

1. Peel and devein prawns, leaving tails intact.
2. Combine butter and garlic in a large microwave safe bowl. Cook for 1½-2 minutes on 1100W.
3. Stir in oil and prawns.
4. Cook for 4-6 minutes on 550W, tossing every 2 minutes. Sprinkle with parsley.
5. Serve in individual dishes with garlic bread.

CHICKEN CACCIATORE

Serves 6

6 chicken thighs
1/4 cup flour
1 tablespoon Season All salt
1 onion, sliced
30 g butter
1 clove garlic, crushed

2 tablespoons tomato paste
440 g can peeled tomatoes
2 chicken stock cubes
1/2 cup white wine
1 green capsicum, thinly sliced
6 black olives, sliced

1. Place chicken, flour and season all salt into a freezer bag. Toss until chicken is coated.
2. Combine chicken thighs, remaining flour, onion, butter, garlic, tomato paste, juice from tomatoes, stock cubes and white wine in a 5 litre casserole dish.
3. Cover and cook for 26-28 minutes on 770W. Stir 2-3 times during cooking.
4. Add capsicum and chopped tomatoes. Cover and cook a further 10-12 minutes on 770W.
5. Garnish with black olives.

CRUNCHY CAMEMBERT CHICKEN

Serves 6

125 g camembert cheese, finely chopped
2 rashers bacon, finely chopped
1/2 cup toasted, slivered almonds
2 tablespoons seeded mustard
Approx. 1.5kg chicken
2 tablespoons honey

1. Mix camembert, bacon, almonds and 1 tablespoon mustard together in a small bowl.
2. Press camembert mixture between skin and flesh of chicken. Tie chicken legs together.
3. Mix remaining mustard and honey. Brush over chicken.
4. Place breast side down on the low rack, cook for 40 minutes on Convection 200°C .
5. Turn chicken over and brush with remaining mixture. Cook for a further 20 minutes on COMBI C3.
6. Allow to stand covered with foil for 10 minutes before serving.

CHICKEN FILLET BURGERS

Serves 4

4 chicken breast fillets (approx. 500 g)
2 tablespoons flour
1 teaspoon paprika
2 slices ham, sliced in half
2 slices pineapple, sliced in half
4 slices cheese

1. Place chicken, flour and paprika into a freezer bag. Toss until chicken is coated.
2. Place chicken fillets in a dish.
3. Cook for 8-10 minutes on 770W, turning over halfway through cooking.
4. Place ham and pineapple slices on top of each chicken piece.
5. Top with cheese.
6. Cook for 10 minutes on GRILL.
7. Serve on a hamburger bun with lettuce and tomato.

ROAST CHICKEN

Serves 4

Approx. 1.5 kg chicken
30 g butter, melted
Season All salt

1. Wash and dry chicken well.
2. Tie legs of chicken together with string.
3. Place breast-side down on the low rack.
4. Baste with butter and sprinkle with Season All salt.
5. Cook for 40 minutes on convection 200°C .
6. Turn chicken over. Baste with butter and sprinkle with Season All salt.
7. Cook for a further 20 minutes on COMBI C3.
8. Allow to stand covered with foil for 10 minutes before serving.

CHICKEN AND MACARONI BAKE

Serves 4-6

1 cooked chicken (approx. 1.5 kg)
20 g butter, melted
2 cups macaroni
1/4 cup plain flour
300 mL sour cream
1 cup chicken stock
1 cup grated cheese
1 tablespoon chopped parsley

1. Place macaroni in a large microwave safe bowl. Cover with hot water. Cook for 16 minutes on 1100W, stirring half way through or until pasta is tender. Drain.
2. Remove flesh from chicken.
3. Mix together plain flour, sour cream and chicken stock.
4. Combine chicken, macaroni and sauce mixture in a 3 litre casserole dish. Sprinkle with cheese and cook for 10-12 minutes on 770W and 4-5 minutes on GRILL.
5. Sprinkle with parsley.
6. Serve immediately with a tossed salad.

APRICOT CHICKEN

Serves 4

4 chicken thighs
1 packet French onion soup
2 tablespoons plain flour
125 mL apricot nectar
825g can apricot halves, drained

1. Toss chicken in combined French onion soup and plain flour.
2. Place in a 3 litre casserole dish.
3. Cook chicken for 13-15 minutes on 770W. Turn chicken over.
4. Pour over apricot nectar and apricots.
5. Cook, covered, for 13-15 minutes on 770W.
6. Serve hot with pasta.

CHEESE AND HERB CHICKEN LEGS

Serves 4

2 tablespoons chopped parsley
1 teaspoon basil
2 teaspoons tarragon
2 teaspoons dill
2 teaspoons mustard powder
1 teaspoon paprika
salt and pepper
1 teaspoon sesame seeds
90 g butter, melted
8 large chicken drumsticks
125 g country cheese biscuits, crushed

1. Mix parsley, basil, tarragon, dill, mustard powder, paprika, salt and pepper, sesame seeds and one-third of butter together in a small bowl.
2. Using a sharp knife, lift skin back from the chicken drumsticks.
3. Spread a teaspoon of herb mixture between skin and chicken.
4. Brush chicken with remaining butter, coat with biscuit crumbs.
5. Place on the high rack and cook for 25 minutes on Convection 200°C .
6. Turn over and cook for a further 15 minutes on COMBI C3.
7. Allow to stand for 5-10 minutes before serving.

HONEY CHICKEN LEGS

Serves 4

250 mL soy sauce
4 tablespoons honey
1 tablespoon lemon juice
1 clove garlic, crushed
1/2 teaspoon freshly grated ginger
2 tablespoons oil
8 large chicken legs
sesame seeds

1. Combine soy sauce, honey, lemon juice, garlic, ginger and oil in a small bowl. Pour over chicken and marinate for 2-3 hours.
2. Arrange the chicken legs on the high rack lined with foil. Cook for 25 minutes on Convection 200°C .
3. Turn chicken over and cook for a further 15 minutes on Convection 200°C .
4. Sprinkle with sesame seeds.

CHICKEN PROVENCALE

Serves 4

1/2 cup white wine	1 teaspoon curry powder
425 g can peeled tomatoes	1.25 kg chicken pieces, skin removed (or 4 marylands)
1 large onion, chopped	250 g button mushrooms, sliced
1 apple, peeled and chopped	chopped parsley
1/2 cup black olives	

1. In a large jug combine wine, tomatoes, onion, apple, olives and curry powder. Mix well.
2. Arrange chicken pieces in a casserole dish. Pour over sauce. Cover and cook for 27-29 minutes on 770W. Stir once during cooking.
3. When oven stops, stir in mushrooms. Cover and cook for a further 5-7 minutes on 770W.
4. Sprinkle with parsley.

CHICKEN TERRINE

Serves 6-8

60 g butter	250 g cream cheese, softened
6 shallots, chopped	1 cooked chicken, chopped
1/2 cup flour	2 teaspoons green peppercorns, chopped
1 cup chicken stock	3 teaspoons gelatine
1 cup milk	1/2 cup water
1/4 teaspoon tabasco sauce	6 rashers bacon

1. Melt butter in a microwave safe bowl for 40 seconds on 1100W. Add shallots and flour. Cook for 1 minute on 1100W.
2. Gradually stir in stock and milk. Cook for 4-5 minutes on 1100W, stirring every 2 minutes.
3. Stir in tabasco sauce and pepper.
4. Beat cream cheese. Gradually stir in the sauce. Add chicken and peppercorns.
5. In a small microwave safe bowl dissolve gelatine in water. Cook for 40 seconds - 1 minute on 1100W; add to chicken mixture.
6. Line 25 cm x 11 cm loaf dish with paper towel and place bacon across paper towel.
7. Cover with paper towel and cook for 3-5 minutes on 1100W.
8. Remove top layer of paper towel.
9. Pour in chicken mixture. Refrigerate overnight.
10. Turn out and slice. Serve with Melba toast.

WHOLEMEAL CHICKEN

Serves 4

1 kg chicken thighs
100 g butter, melted
1/4 cup finely grated parmesan cheese
1 cup wholemeal flour
1 tablespoon chopped parsley

1. Dip chicken thighs in butter.
2. Coat with combined cheese, flour and parsley.
3. Place on the low rack. Cook for 14 minutes on COMBI C3 and 5-6 minutes on GRILL.
4. Turn over and cook for a further 8-9 minutes on GRILL.

TANDOORI CHICKEN

Serves 4-6

2 fresh red chillies, seeded	2 whole cloves
1 onion	1/4 teaspoon cinnamon
2 cloves garlic, crushed	1 bay leaf
2 teaspoons crushed ginger	1/2 teaspoon turmeric
2 tablespoons lemon juice	1/2 teaspoon nutmeg
2 teaspoons ground cumin	2 teaspoons paprika
1/2 teaspoon black pepper	6 chicken thighs, skin removed
1/2 teaspoon salt	1 tablespoon vinegar
3 teaspoons ground coriander	200 g low-fat yoghurt

1. Purée chillies, onion, garlic, ginger and lemon juice until smooth.
2. Mix cumin, pepper, coriander, cloves, cinnamon, bay leaf, turmeric, nutmeg and paprika in a small microwave safe bowl.
3. Cook for 1 minute on 1100W, stirring halfway through cooking. Remove bay leaf and cloves.
4. Combine chilli mixture and spices together. Spread over chicken.
5. Sprinkle with vinegar and pour over yoghurt. Cover and marinate overnight, stirring occasionally.
6. Place on the high rack, cook for 25 minutes on COMBI C3.
7. Turn over and cook for a further 25 minutes on COMBI C3.
8. Serve with boiled rice.

POULTRY

CHICKEN IN A POT

Serves 4-6

1.5 kg chicken thighs
1/4 cup plain flour
2 rashers bacon, finely chopped
1 green capsicum, diced
1 onion, finely chopped
400 g can peeled tomatoes

2 tablespoons tomato paste
2 chicken stock cubes
1 tablespoon soy sauce
salt and pepper
200 g mushrooms, sliced

1. Toss chicken thighs in flour.
2. Combine all ingredients, except mushrooms, in a 3 litre casserole dish.
3. Cover and cook for 30 minutes on 770W. Stir 2-3 times during cooking.
4. Add mushrooms. Cook, uncovered, a further 5-7 minutes on 770W.

CHICKEN FRICASSEE

Serves 4

1 large cooked chicken
60 g butter
3 tablespoons flour
2 cups chicken stock
1 egg yolk

1/4 cup cream
1/4 teaspoon nutmeg
300 g jar artichoke hearts, halved
4 slices processed cheese
chopped parsley

1. Remove meat from chicken and chop into cubes.
2. Melt butter for 40-50 seconds on 1100W in a microwave safe jug. Stir in flour; cook a further 40 seconds.
3. Gradually stir in chicken stock. Cook for 5-6 minutes on 1100W, stirring halfway through cooking.
4. Stir in chopped chicken, egg yolk, cream, nutmeg and artichokes.
5. Pour into a 2 litre casserole dish. Cover and cook for 4-6 minutes on 770W. Stir well.
6. Lay cheese slices across middle of dish. Cook a further 10-12 minutes on 770W.
7. Sprinkle with parsley.

CHICKEN WITH BACON AND LEEK SEASONING

Serves 4

Aprox. 1.5 kg chicken
60 g butter, melted
1 leek, finely chopped
2 rashers bacon, chopped

1 1/2 cups wholemeal breadcrumbs
1 egg yolk
salt and pepper

1. Combine butter, leek and bacon in a microwave safe bowl. Cook for 1-2 minutes on 1100W.
2. Stir in breadcrumbs, egg yolk and seasonings. Mix well.
3. Fill cavity of chicken with stuffing and secure with a toothpick.
4. Place chicken on the low rack, breast-side down, cook for 12-14 minutes on COMBI C3 and 7 minutes on GRILL.
5. Turn over, cook a further 12-14 minutes on COMBI C3 and 7 minutes on GRILL.
6. Stand covered with foil for 10 minutes before carving.

CHICKEN AND APRICOT SALAD

Serves 6

Aprox. 1.5 kg chicken
20 g butter
1/2 cup mayonnaise
1/4 cup sour cream
1 tablespoon lemon juice
6 ripe fresh apricots, cut into wedges
2 sticks celery, thinly sliced
1/4 teaspoon dried tarragon

1. Melt butter in a microwave safe bowl for 20 seconds on 1100W, brush chicken with butter. Cook on the low rack for 12-14 minutes on COMBI C3 and 7 minutes on GRILL.
2. Turn over, brush chicken with butter, and cook for a further 12-14 minutes on COMBI C3 and 7 minutes on GRILL.
3. Remove chicken flesh from the bone.
4. Combine mayonnaise, sour cream and lemon juice. Stir in apricots, chicken, celery and tarragon until coated. Chill for 1-2 hours.
5. To serve, line a salad bowl with lettuce leaves. Spoon in salad.

NOTE: Leftover turkey may be substituted for chicken.

HAMBURGER

Serves 6

500 g mince
1 onion, chopped
1 egg
1 tablespoon tomato sauce
1 teaspoon mixed herbs
1 teaspoon seasoned pepper
³/₄ cup breadcrumbs

1. In a large bowl, combine mince, onion, egg, tomato sauce, mixed herbs, seasoned pepper and breadcrumbs.
2. Shape into 6 equal patties. Place patties on the high rack lined with foil. Cook for 15 minutes on COMBI C3.
3. Drain juices, turn patties over and cook for a further 15 minutes on COMBI C3.
4. Serve on hamburger bun with lettuce and tomato.

GRILLED KEBABS

Serves 4

400 g lamb
1 large onion, coarsely chopped
1 green capsicum, coarsely chopped

1. Cut lamb into cubes.
2. Thread capsicum, onion and chicken onto 8 skewers.
3. Place on the high rack and cook for 10-15 minutes on GRILL.
4. Turn over and cook for a further 10-15 minutes on GRILL.
5. Serve on a bed of rice.

PORK RIBS WITH CHILLI PLUM SAUCE

Serves 4

750 g pork ribs
1 tablespoon oyster sauce
2 tablespoons dry sherry
1 tablespoon soy sauce
3 teaspoons black beans sauce
1¹/₂ teaspoons five spice powder
1¹/₂ teaspoon pepper
1¹/₄ teaspoon salt

CHILLI PLUM SAUCE

2 teaspoons oil
1 clove garlic
1¹/₂ teaspoon grated green ginger
2 shallots, chopped
210 mL bottle plum sauce
1¹/₂ teaspoon chilli sauce
1 chicken stock cube
1¹/₃ cup water
2 teaspoons soy sauce
2 teaspoons cornflour

Sauce Method

1. In a large microwave safe bowl combine the oil, crushed garlic, ginger, chopped shallots. Cook for 1-2 minutes on 1100W.
2. Add plum and chilli sauce, stir until combined.
3. Combine water, stock cube, soy sauce and cornflour. Add to mixture. Cook for a further 2 minutes on 1100W, until mixture begins to thicken.

Method

1. Remove excess fat from ribs.
2. In a large bowl combine oyster sauce, sherry, soy sauce, black beans sauce, five spice powder, pepper and salt.
3. Dip each rib into black bean mixture. Place ribs on the high rack lined with foil. Cook for 15 minutes on COMBI C3.
4. Turn ribs over, brush each side with chilli plum sauce. Cook for a further 10 minutes on COMBI C3 or until golden brown.
5. Serve with remaining sauce.

BREAKFAST GRILL

Serves 1

1 flat mushroom(approx. 80g) 1 thick sausage
1/2 tomato 1 egg
1 rasher bacon

1. Place mushroom, tomato, sausage (pierced 3 times), bacon and egg on the high rack lined with foil. Cook for 10 minutes on COMBI C3.
2. Turn food over and cook for a further 10 minutes on COMBI C3.

APRICOT AND ALMOND CRUSTY LAMB

Serves 4

200 g dried apricots, finely chopped
1 cup fresh breadcrumbs
1/2 cup ground almonds
2 teaspoons dried rosemary
1 egg, lightly beaten
1 rack of lamb (approx. 8 chops)
1 tablespoon apricot jam

1. Mix together in a small bowl, apricots, breadcrumbs, ground almonds, rosemary and egg.
2. Brush lamb with apricot jam.
3. Place apricot crust on top of lamb.
4. Place on the low rack. Cook for 22-24 minutes on 550W and 3 minutes on GRILL. Allow to stand 10 minutes covered with foil before carving.

FILLET MIGNON

Serves 4

4x scotch fillet steaks, approx 2.5 cm thick (approx. 200 g each)
4 rashers bacon

1. Remove rind of bacon.
2. Wrap 1 rasher of bacon around each fillet, secure with a toothpick.
3. Place on the high rack lined with foil.
4. Cook for 8 minutes on COMBI C3.
5. Turn over and drain juices, cook for a further 5 minutes on COMBI C3.
6. Remove toothpick before serving.
7. Serve with mushroom sauce.

HONEY ROAST LAMB

Serves 4-6

1.5 kg leg lamb
3 tablespoons honey
1 tablespoon Dijon mustard

1. Combine honey and Dijon mustard in a small bowl.
2. Place fat-side down on the low rack.
3. Preheat to Convection 200°C. Place lamb leg on the low rack and cook for 50 minutes at 200°C. Turn over half way through cooking.

4. Allow to stand 10 minutes covered with foil before carving.

SPINACH LOIN OF LAMB

Serves 4-6

1.0 kg loin of lamb
1 large spinach leaf, shredded
20 g butter
1 large onion, chopped
salt and pepper

1. Butterfly loin of lamb and flatten slightly with a meat mallet.
2. Spread with shredded spinach.
3. Place butter and onion in a microwave safe glass bowl. Cook for 3 minutes on 1100W. Sprinkle over spinach.
4. Season with salt and pepper.
5. Roll up loin and secure with string.
6. Preheat oven to Convection 200°C. Place lamb on the low rack and cook for 50 minutes at 200°C. Turn over half way. Stand for 20 minutes before serving.

BEEF MADEIRA

Serves 4-6

750 g blade or round steak, cubed
1/4 cup plain flour
1 large onion, sliced
2 carrots, thinly sliced
1 clove garlic, crushed
1/2 cup beef stock
1/2 cup madeira or sherry
1/2 teaspoon paprika
350 g beans, washed and sliced
1 green capsicum, sliced

1. In a 3 litre casserole dish, combine meat and flour; mix well.
2. Add onions and carrots.
3. In a jug, combine garlic, beef stock, madeira or sherry, and paprika; stir well. Pour over beef.
4. Cook, covered, for 20-22 minutes on 550W, stirring 2-3 times during cooking.
5. Add beans and capsicum. Cover and cook a further 24-26 minutes on 550W, stirring twice during cooking.

TROPICAL LAMB CURRY

Serves 4-6

1 onion, thinly sliced
1 kg lamb, trimmed and cubed
1 cup chicken stock
1 teaspoon chicken stock powder, extra
3 teaspoons curry powder
810 g can apricot halves, drained, reserving 1/2 cup syrup
2 tablespoons arrowroot

1. Place onion, lamb, chicken stock, stock powder and curry powder into a 3-litre casserole dish.
2. Cover and cook for 28-30 minutes on 550W; stir twice during cooking.
3. Drain lamb and reserve 1/2 cup of liquid.
4. Combine liquid, apricot syrup and arrowroot. Cook for 1-2 minutes on 1100W.
5. Combine lamb, apricots and stock mixture and liquid, together in a 3 litre casserole dish and cover.
6. Heat through for 12-14 minutes on 550W.
7. Serve with boiled rice.

MINTED PICNIC LOAF

Serves 6-8

2 cups stale breadcrumbs
1/2 cup milk
1 large potato, grated
500 g sausage mince
500 g minced beef
1/2 cup tomato sauce
2 tablespoons chopped fresh mint

TOPPING

1 cup grated fresh parmesan cheese
1 cup stale breadcrumbs
1 tablespoon chopped fresh mint

1. Combine breadcrumbs and milk in large bowl; stand for 5 minutes.
2. Add potato, mince, tomato sauce and mint to breadcumb mixture; mix well.
3. Press mixture into an 11 cm x 25 cm loaf dish lined with baking paper.
4. Place on low rack. Cook for 25-28 minutes on 550W.
5. Drain excess liquid from loaf dish.

TOPPING

1. Combine topping ingredients and press evenly over loaf. Cook for a further 3-4 minutes on GRILL.
2. Allow to stand 10 minutes before turning out. Serve hot or cold.

CHILLI CON CARNE

Serves 4-6

1 kg mince
1 large onion, finely chopped
825 g can peeled tomatoes
salt and pepper
1-2 teaspoons chilli powder
1 tablespoon vinegar
1 teaspoon sugar
375 g jar tomato paste
425 g can red kidney beans, drained

1. Mix mince and onion together in a large microwave safe bowl. Cook for 10-12 minutes on 770W, stirring every 2 minutes.
2. Stir in tomatoes, salt and pepper, chilli powder, vinegar, sugar, tomato paste and kidney beans.
3. Cook for 20-22 minutes on 770W, stirring twice during cooking.
4. Serve with boiled rice.

VEAL À LA MEDALLION

Serves 4-6

1 kg veal, cubed
1/2 cup plain flour
salt and pepper
3/4 cup water
1 cup finely chopped shallots
2 carrots, thinly sliced

1/2 teaspoon grated lemon rind
2 rashers bacon, chopped
250 g fresh mushrooms, sliced
300 mL carton sour cream
1 tablespoon chopped chives

1. Toss veal in flour. Place in a 3 litre casserole dish. Stir in salt, pepper, water, shallots, carrots, lemon rind and bacon.
2. Cover and cook for 40 minutes on 550W, stirring 2-3 times during cooking.
3. Stir in mushrooms and sour cream.
4. Cover and cook a further 5-7 minutes on 550W.
5. Sprinkle with chives.

VEAL AND PINEAPPLE

Serves 4-6

2 tablespoons flour
2 teaspoons mixed herbs
1 teaspoon chicken stock powder
black pepper
750 g veal, diced
4 rashers bacon, chopped
3 shallots, chopped
440 g can pineapple pieces, drained
1 cup tomato sauce
2 tablespoons chopped parsley

1. Mix first 4 ingredients together in a large casserole dish.
2. Add the veal; toss to coat in the seasonings. Stir in bacon, shallots, pineapple pieces and tomato sauce.
3. Cover and cook for 35 minutes on 550W, stirring 2-3 times during cooking.
4. Sprinkle with parsley and serve with rice.

HERBED LOIN OF LAMB

Serves 8

1/2 cup white wine
1/4 cup oil
3 cloves garlic, crushed
freshly ground black pepper
1 teaspoon rosemary spikes
1 kg loin of lamb

1. Mix all ingredients except lamb together to form a marinade in a small bowl.
2. Place loin of lamb in a large shallow dish and pour over marinade; leave overnight.
3. Remove loin of lamb from marinade and roll loin tightly, securing with string.
4. Preheat oven to Convection 200°C. Place lamb on the low rack and cook for 50 minutes at 200°C. Turn over half way.
5. Allow to stand 10 minutes covered with foil before carving.

ITALIAN SPAGHETTI SAUCE

Serves 4-6

500 g topside mince
1 onion, chopped
1 clove garlic, crushed
400 g can whole tomatoes
1/2 cup tomato paste
100 g mushrooms, sliced
1 tablespoon chopped parsley
1 teaspoon salt
1/2 teaspoon dried oregano leaves
1/2 teaspoon dried basil leaves

1. Mix mince, onion and garlic together in a large microwave safe bowl. Cook for 8-10 minutes on 770W, stirring every 2 minutes. Drain well.
2. Stir in canned tomatoes, tomato paste, mushrooms, parsley, salt, oregano and basil.
3. Cook a further 8-11 minutes on 770W. Stir halfway through cooking.
4. Serve over hot spaghetti.

SPRINGTIME LAMB CASSEROLE

Serves 4

1 packet (40 g) French onion soup
1/4 cup plain flour
750 g lamb, cubed
4 spring onions, quartered
2 carrots, thinly sliced
1 cup chicken stock
310 g can corn kernels, drained
2 sticks celery, finely chopped
300 mL carton sour cream

1. Combine French onion soup mix and flour in a 2-3 litre casserole dish. Toss the lamb in flour mixture, coating thoroughly.
2. Add onions and carrots, stir in chicken stock and mix well.
3. Cover and cook for 22-24 minutes on 550W, stirring during cooking.
4. Add corn, celery and sour cream. Mix well.
5. Cook a further 16-18 minutes on 550W.

CURRIED SAUSAGES

Serves 4-6

1 kg sausages	3 teaspoons curry powder
40 g butter	1/4 cup sultanas
2 onions, chopped	1 beef stock cube
1 small Granny Smith apple, peeled and finely chopped	1 1/2 cups water
	1/4 cup flour

1. Pierce sausages with a fork twice.
2. Cook for 14-16 minutes on 550W, turning halfway through cooking. Cut sausages into thirds.
3. In a 2-3 litre casserole dish, place butter, onions, apple, curry powder and sultanas; mix well. Cover and cook for 4-6 minutes on 1100W.
4. Dissolve stock cube in water.
5. Mix in flour and stock, cover and cook for 4-5 minutes on 1100W, stirring once.
6. Add sausages and stir.
7. Cover and cook for an extra 6-7 minutes on 550W. Serve with boiled rice or noodles.

BEEF STROGANOFF

Serves 6

1 kg rump steak, cut into strips
1/2 cup plain flour
salt and pepper
1 onion, finely chopped
2 tablespoons tomato purée
1 1/2 cups beef stock
1/4 cup red wine
100 g mushrooms, thinly sliced
300 mL sour cream

1. Toss steak with flour, salt and pepper in a freezer bag until evenly coated.
2. Place steak, left-over flour, onion, tomato purée, beef stock and red wine in a 3 litre casserole dish.
3. Cook, covered, for 35 minutes on 550W, stirring twice during cooking.
4. Stir in mushrooms and sour cream. Cook for a further 4-5 minutes on 550W.
5. Serve with boiled rice.

CORNERD BEEF

Serves 6-8

2 tablespoons brown sugar
2 tablespoons malt vinegar
3 cups hot water
1.5 kg corned beef

1. Place corned beef in a casserole dish just large enough to contain it.
2. Combine brown sugar, malt vinegar and hot water. Pour over corned beef.
3. Cover with lid and cook for 70 minutes on 550W, turning over halfway through cooking. Allow to stand covered with foil for 10 minutes before serving.
4. Serve with white sauce.

MEAT

CRUSTY ROSEMARY LAMB

Serves 4-6

- 1/4 cup brown sugar**
- 2 tablespoons seeded mustard**
- 1 tablespoon lemon juice**
- 2 tablespoons chopped fresh rosemary**
- 1.5 kg leg lamb**

1. Combine brown sugar, mustard, lemon juice and rosemary in a small bowl.
2. Preheat oven to Convection 200°C.
3. Place lamb on the low rack and cook for 70 minutes at 200°C. Turn over half way.
4. Allow to stand 10 minutes covered with foil before carving.

SHEPHERD'S PIE

Serves 6-8

- | | |
|---------------------------------------|--|
| 4 large potatoes (approx.1 kg) | 1 tablespoon gravy powder |
| 20 g butter | 2/3 cup tomato sauce |
| 1 tablespoon milk | 1 tablespoon Worcestershire sauce |
| salt and pepper | 1 tomato, chopped |
| 1 kg minced beef | 2 tablespoons parsley |
| 1 onion, chopped | 1 egg, beaten |

1. Peel and cut potatoes into 2.5 cm cubes. Place in a large microwave safe bowl. Add 2 tablespoons water; cover and cook for 12-14 minutes on 1100W or until tender. Drain.
2. Mash potatoes; add butter, milk, salt and pepper.
3. In a large bowl, combine mince and onion and cook for 10-12 minutes on 770W, stirring every 2 minutes. Drain juices from meat.
4. Add gravy powder, tomato sauce, Worcestershire sauce, tomato and parsley. Mix well.
5. Spoon mixture into a 25 cm x 20 cm rectangular dish.
6. Spread mashed potato evenly over top of mixture. Brush with beaten egg.
7. Cook using the high rack on COMBI C3 for 20-25 minutes, or until the top is crisp.
8. Allow to stand covered with foil for 10 minutes before serving.

LASAGNE

Serves 4-6

MEAT SAUCE INGREDIENTS

- 30 g butter**
- 1 onion, chopped**
- 1 kg topside mince**
- 1/4 cup tomato paste**
- 375 g jar bolognese sauce**
- 280 g can champignons, drained**
- 1 clove garlic, crushed (optional)**

CHEESE SAUCE INGREDIENTS

- 90 g butter**
- 1/3 cup flour**
- 1 3/4 cups milk**
- 125 g tasty cheese, grated**
- 250 g packet instant lasagne sheets**
- 100 g mozzarella cheese, grated**

MEAT SAUCE METHOD

1. Place butter and onion in a microwave safe glass bowl. Cook for 2-3 minutes on 1100W.
2. Stir in mince. Cook, uncovered, for 12-14 minutes on 770W, stirring every 2 minutes. Drain excess fat.
3. Stir in tomato paste, bolognese sauce, champignons and garlic.

CHEESE SAUCE METHOD

1. Melt butter for 50-60 seconds on 1100W. Stir in flour; cook for further 1 minute on 1100W.
2. Gradually stir in milk. Cook for 4-6 minutes on 1100W, stirring every minute.
3. Stir in tasty cheese.

TO COMBINE

1. Use a 25 x 25 cm deep casserole dish.
2. Dip lasagne sheets in hot water, then cover base of dish.
3. Spoon over sheets one-third of meat sauce. Cover with one-third of cheese sauce.
4. Repeat the process 3 times, ending with the cheese sauce.
5. Sprinkle with mozzarella cheese.
6. Cook using the low rack on COMBI C3 for 30-35 minutes.
7. Allow to stand 10 minutes before serving.
8. Serve with a fresh garden salad and bread.

APPETISERS

QUICK NACHOS

Serves 4

- 200 g packet corn chips**
- 250 g jar of salsa**
- 1/2 cup sour cream**
- 2 tablespoons tomato paste**
- 1/4 cup grated tasty cheese**

1. Place corn chips in base of a glass pie dish.
2. Mix salsa and sour cream together in a small bowl. Pour over corn chips.
3. Spread tomato paste over the top of salsa.
4. Sprinkle with cheese.
5. Place on the low rack and cook for 6 1/2 minutes on GRILL.
6. Serve immediately with guacamole.

GARLIC AND HERB FOCACCIA

- 1 focaccia (rectangular)**
- 100 g margarine**
- 2 cloves garlic, crushed**
- 1 teaspoon mixed herbs**

1. Carefully cut bread in half.
2. Mix margarine, garlic and herbs together in a small bowl.
3. Spread evenly over focaccia. Place onto the high rack side by side.
4. Cook for 4-5 minutes on GRILL.
5. Cut into strips and serve hot.

VEGETABLE FRITTATA

Serves 4

- 2 large potatoes, peeled and thinly sliced**
- 1 onion, thinly sliced**
- 5 eggs**
- 450 mL sour cream**
- 330 g can asparagus spears, drained**
- 1/2 red capsicum, cut into strips**
- 2 zucchinis, cut into strips**
- 2 tablespoons parmesan cheese**

1. Arrange potatoes and onion over base of greased 23 cm glass pie plate.
2. Combine eggs and sour cream. Pour half the mixture over potatoes.
3. Place dish directly onto the turntable. Cook for 10-12 minutes on 770W.
4. Arrange asparagus, capsicum and zucchinis in a circle over potato. Pour over remaining egg mixture. Sprinkle with cheese.
5. Place dish directly on the turntable and cook for 18-20 minutes on 770W.
6. Stand covered with foil for 5 minutes.
7. Cut into wedges.

RECIPES

INDEX

APPETISERS

GARLIC AND HERB FOCACCIA
QUICK NACHOS
VEGETABLE FRITTATA

MEAT

APRICOT AND ALMOND CRUSTY LAMB
BEEF MADEIRA
BEEF STROGANOFF
BREAKFAST GRILL
CHILLI CON CARNE
CORNEBEEF
CRUSTY ROSEMARY LAMB
CURRIED SAUSAGES
FILLET MIGNON
GRILLED KEBABS
HAMBURGER
HERBED LOIN OF LAMB
HONEY ROAST LAMB
ITALIAN SPAGHETTI SAUCE
LASAGNE
MINTED PICNIC LOAF
PORK RIBS WITH CHILLI PLUM SAUCE
SHEPHERD'S PIE
SPINACH LOIN OF LAMB
SPRINGTIME LAMB CASSEROLE
TROPICAL LAMB CURRY
VEAL À LA MEDALLION
VEAL AND PINEAPPLE

POULTRY

APRICOT CHICKEN
CHEESE AND HERB CHICKEN LEGS
CHICKEN AND APRICOT SALAD
CHICKEN AND MACARONI BAKE
CHICKEN CACCIATORE

POULTRY continued

CHICKEN FILLET BURGERS
CHICKEN FRICASSEE
CHICKEN IN A POT
CHICKEN PROVENCALE
CHICKEN TERRINE
CHICKEN WITH BACON AND
LEEK SEASONING
CRUNCHY CAMEMBERT CHICKEN
HONEY CHICKEN LEGS
ROAST CHICKEN
TANDOORI CHICKEN
WHOLEMEAL CHICKEN

SEAFOOD

BOUILLABAISSA
CHEESY SALMON CANNELLONI
CRAB MORNAY
CRISPY MARINATED CRAB STICKS
CURRIED SCALLOPS
GARLIC MUSSELS
GARLIC PRAWNS
MARINATED BABY OCTOPUS
OYSTERS KILPATRICK
PRAWN CUTLETS
PRAWN CREOLE
SCALLOPS IN BLACK BEAN SAUCE
SEAFOOD LASAGNE
SESAME PRAWNS
SQUID IN TOMATO AND WINE SAUCE
TAGLIATELLE AND CRAB SALAD

VEGETABLES

CAULIFLOWER AU GRATIN
CHUNKY VEGETABLE SOUP
EASY HOME-MADE RICE RISOTTO
GRILLED TOMATOES
GRILLED ZUCCHINI WITH FETA AND MINT

VEGETABLES continued

HONEY CARROTS
HONEY GINGERED VEGETABLES
POTATOES PIZZAIOLA
POTATO, AVOCADO AND ONION SALAD
PUMPKIN SALAD
ROAST VEGETABLES
SCALLOPED POTATOES
SOY AND SESAME GREEN BEANS
SQUASH WITH YOGHURT
STUFFED BAKED POTATOES
STUFFED MUSHROOMS
VEGETABLE PLATTER

DESSERTS

APRICOT WHEATGERM CRUNCHIES
AUSTRALIAN FRUIT CAKE
BAKED APPLES
BREAD AND BUTTER PUDDING
CALIFORNIAN APPLE CRUNCH
CARAMEL RICE PUDDING
CHOCOLATE MOUSSE
CHOCOLATE CAKE
CHOCOLATE CHIP COOKIES
CHOCOLATE SELF-SAUCING PUDDING
MUESLI CUSTARD DELIGHT

CHARTS

DEFROSTING CHARTS
FRESH VEGETABLE CHART
FROZEN VEGETABLE CHART
CONVECTION CHART
GUIDE TO COOKING EGGS
REHEATING CONVENIENCE
DEFROSTING CONVENIENCE-FOOD CHART
ROAST MEAT AND POULTRY CHART
RICE AND PASTA COOKING CHART

INVERTER MICROWAVE COOK MENU GUIDE

RICE/ PASTA

To use the following menus, press RICE/PASTA until the desired menu appears on the display.

Menu	Weight Range				Initial Temperature (approx.)	Procedure	Standing Time (minutes)
White Rice	1 - 4 Cups				+40°C Hot tap water	- Place into a microwave safe glass bowl and cover with hot tap water. - Cook uncovered. - When the oven stops, stir and continue cooking. - After cooking, stand and stir.	2
	Rice	1 Cup	2 Cup	4 Cup			
	Hot tap water	2 Cups	4 Cups	6 Cups			
Brown Rice	1 - 4 Cups				+40°C Hot tap water	- Place into a microwave safe glass bowl and cover with hot tap water. - Cook uncovered. - When the oven stops, stir and continue cooking. - After cooking, stand and stir.	2
	Brown Rice	1 Cup	2 Cup	4 Cup			
	Hot tap water	2 Cups	4 Cups	6 Cups			
Pasta	100g - 400g				+40°C Hot tap water	- Place into a microwave safe glass bowl and cover with hot tap water. - Cook uncovered. - When the oven stops, stir and continue cooking. - After cooking, stand and stir.	2
	Pasta	100g	200g	400g			
	Hot tap water	2 Cups	4 Cups	6 Cups			
Wholemeal Pasta	100g - 400g				+40°C Hot tap water	- Place into a microwave safe glass bowl and cover with hot tap water. - Cook uncovered. - When the oven stops, stir and continue cooking. - After cooking, stand and stir.	2
	Wholemeal Pasta	100g	200g	400g			
	Hot tap water	2.5 Cups	4.5 Cups	6.5 Cups			

VEGETABLES/ QUINOA

To use the following menus, press VEGETABLES/QUINOA until the desired menu appears on the display.

Menu	Weight Range				Initial Temperature (approx.)	Procedure	Standing Time (minutes)
Fresh Vegetables	150g - 500g				+3°C Refrigerated	- Wash the vegetables. - Place into a microwave safe glass bowl with 1 tablespoon of water. - Cook uncovered.	2
Frozen Vegetables	150g - 500g				-18°C	- Place into a microwave safe glass bowl. - Cook uncovered.	2
Sweet Jacket Potato	1 - 2 Sweet Potatoes				+20°C Room Temperature	- Use washed and dried sweet potatoes. - Pierce the skin twice with a fork on each side. - Place directly onto the turntable. - When oven stops, turn over and continue cooking.	2
Quinoa	1 Cup - 2 Cups				+40°C Hot tap water	- Wash quinoa until water runs clear. - Place into a microwave safe bowl and cover with hot tap water. - Cook uncovered. - When the oven stops, stir and continue cooking. - After cooking stand and stir.	5
	Quinoa	1 Cup	2 Cups				
	Hot tap water	2 Cups	4 Cups				

INVERTER MICROWAVE COOK MENU GUIDE

**MELT/
SOFTEN**

To use the following menus, press MELT/SOFTEN until the desired menu appears on the display.

Menu	Weight Range	Initial Temperature (approx.)	Procedure
Chocolate	100g -250g	+20°C Room Temperature	- Break chocolate into cubes and place into a microwave safe glass bowl. - Cook uncovered. - When the oven stops, stir and continue cooking.
Butter	100g -250g	+3°C Refrigerated	- Chop butter into cubes and place into a microwave safe glass bowl. - Cook uncovered. - When the oven stops, stir and continue cooking.
Cream Cheese	100g -250g	+3°C Refrigerated	- Chop cream cheese into cubes and place into a microwave safe glass bowl. - Cook uncovered. - When the oven stops, stir and continue cooking.

CONVENIENCE MENU GUIDE

REHEAT

To use the following menus, press REHEAT until the desired menu appears on the display.

Menu	Weight Range	Initial Temperature (approx.)	Procedure	
Reheat Plate	1 Serve (approx. 400g)	+3°C Refrigerated	- Cover with plastic wrap. Pierce plastic wrap with a fork.	
	Meat			Vegetables
	200g			200g
Reheat Beverage	1 Cup (approx. 250ml)	+20°C Room Temperature	- Use a microwave safe mug.	

DEFROST

To use the following menus, press DEFROST until the desired menu appears on the display.

Menu	Weight Range	Initial Temperature (approx.)	Procedure	Standing Time (minutes)
Mince	0.5kg - 1kg	-18°C	- Place mince on a defrost rack. - When the oven stops, turn over and shield warm portions with foil strips. - After defrost time, stand covered with foil.	10 - 15
Steak / Chops	0.5kg - 1kg	-18°C	- Place steak / chops on a defrost rack. - When the oven stops, turn over and shield warm portions with foil strips. - After defrost time, stand covered with foil.	10 - 15
Roast Meat	1kg - 2kg	-18°C	- Place roast meat on a defrost rack. - When the oven stops, turn over and shield warm portions with foil strips. - After defrost time, stand covered with foil.	15 - 20
Whole Chicken	1kg - 2kg	-18°C	- Remove from original packaging. Shield wing and leg tips with foil. - Place breast side down on defrost rack. - When the oven stops, turn over and shield warm portions with foil. - After defrost time, stand covered with foil.	15 - 20
Chicken Fillet	0.5kg - 1kg	-18°C	- Place chicken fillets on a defrost rack. - When the oven stops, turn over and shield warm portions with foil strips. - After defrost time, stand covered with foil.	10 - 20
Fish Fillet	0.5kg	-18°C	- Place fish fillets on a defrost rack. - When the oven stops, turn over and shield warm portions with foil strips. - After defrost time, stand covered with foil.	5

FAN FORCED COOK MENU GUIDE

ROAST To use the following menus, press ROAST until the desired menu appears on the display.

Menu	Weight Range	Initial Temperature (approx.)	Procedure	Standing Time (minutes)
Roast Chicken	1kg - 2kg	+3°C Refrigerated	- Place chicken on the low rack. - When the oven stops, turn over the chicken and continue to cook. - After cooking, stand covered with foil.	15 - 20
Roast Beef	1kg - 2kg	+3°C Refrigerated	- Place beef on the low rack. - When the oven stops, turn over the beef and continue to cook. - After cooking, stand covered with foil.	15 - 30
Roast Lamb	1kg - 2kg	+3°C Refrigerated	- Place lamb on the low rack. - When the oven stops, turn over the lamb and continue to cook. - After cooking, stand covered with foil.	15 - 30
Roast Pork	1kg - 2kg	+3°C Refrigerated	- Place pork on the low rack. - When the oven stops, turn over the pork and continue to cook. - After cooking, stand covered with foil.	15 - 20

BAKE To use the following menus, press BAKE until the desired menu appears on the display.

Menu	Weight Range	Initial Temperature (approx.)	Procedure
Butter Cake	1 Cake	+20°C Room Temperature	Recipe: Ingredients: 180g salted butter, softened 3/4 cup caster sugar 2 eggs 1 tablespoon vanilla essence 1 1/2 cups self raising flour 1/2 cup milk Method: 1) In a large bowl beat the butter and sugar together until light and fluffy. 2) Add vanilla essence and eggs, beat until well combined. 3) Add the flour and milk, fold through the mixture until well combined. 4) Transfer mixture to a lined 21cm cake tin and place on the low rack. 5) After cooking, allow cake to stand for 10 minutes before turning out onto a wire rack to cool.
Frozen Lasagne	1 Serve (approx. 400g)	-18°C	- Remove lasagne from original packaging and transfer to an oven safe dish. - Cook on the low rack.





FAN FORCED COOK MENU GUIDE

**MEAT
PIE**

To use the following menus, press MEAT PIE until the desired menu appears on the display.

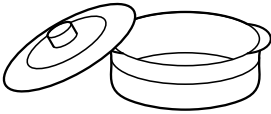
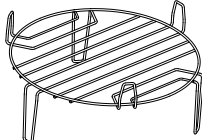
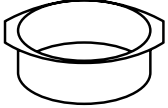
Menu	Weight Range	Initial Temperature (approx.)	Procedure	Standing Time (minutes)
Standard Pie, Refrigerated	1 - 4 Pies (approx. 150g)	+3°C Refrigerated	- Remove pie from original packaing and place directly onto the low rack. - When the oven stops, turn pie over and continue cooking. - After cooking allow pie to stand.	2
Standard Pie, Frozen	1 - 4 Pies (approx. 150g)	-18°C	- Remove pie from original packaing and place directly onto the low rack. - When the oven stops, turn pie over and continue cooking. - After cooking allow pie to stand.	2
Party Pies	10 Party Pies	-18°C	- Remove pies from original packaing and place directly onto the low rack. - After cooking allow pies to stand.	2

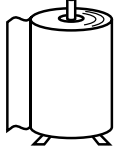
COOKWARE & UTENSIL GUIDE

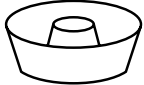
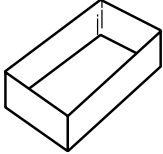
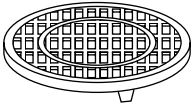
		MICROWAVE	GRILL	COMI. COOKING	CONVECTION
					
OVENPROOF GLASS	METAL RACKS				
					
CAKE TIN	PIZZA TRAY				
					
PAPER TOWEL	FOIL				
					
RING CENTRE DISH	SQUARE DISH				
					
DEFROST RACK					
METAL RACKS		NO	YES	YES (C2 & C3 only)	YES
GLASSWARE/CERAMIC (HEAT RESISTANT)		YES	YES	YES	YES
METAL COOKWARE		NO	YES	*1 YES (C2 & C3 only)	YES
OVEN BAGS		YES	NO	NO	NO
ALUMINIUM FOIL		For Shielding	YES	For Shielding	YES
NON-STICK PAPER		YES	NO	NO	NO
GREASE-PROOF PAPER		YES	NO	NO	NO
WAXED PAPER		YES	NO	NO	NO
PLASTIC WRAP		*2 YES (microwave safe wrap only)	NO	NO	NO
PAPER TOWEL		YES	NO	NO	NO
PLASTIC COOKWARE MICROWAVE SAFE		*3 YES	NO	NO	NO
BROWNING DISH		YES	NO	NO	NO
DEFROST RACK		Defrost Only	NO	NO	NO
THERMOMETERS MICROWAVE SAFE		YES	NO	NO	NO
CONVENTIONAL		NO	NO	NO	NO

*1 When using metal utensil, place a heat resistant dish between the metal utensil and the rack (refer to page ②).

*2 For cooking food with high fat contents, do not bring the wrap in contact with the food as it may melt.

*3 Some microwave safe plastic cookware are not suitable for cooking foods with high fat and sugar content.

HELPFUL HINTS

GRILL COOKING

1. Use thick oven mittens when removing the food or turntable from the oven to **PREVENT BURNS**. Because the oven cavity, door, turntable, turntable support, racks, dishes and especially the grill will become very hot.
2. Foods may be cooked either directly on turntable, or using the high or low racks.

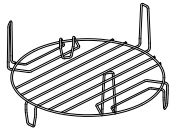

LOW RACK

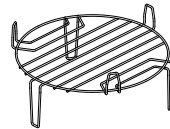

HIGH RACK

MIX COOKING

1. There are four automatic, preprogrammed mix settings.

COMBI	C-1	C-2	C-3	C-4
	Microwave+Convection	Microwave+Grill	Grill+Convection	Microwave+Grill+Convection
Microwave	•	•		•
Grill		•	•	•
Fan-Forced Convection	•		•	•

2. Use thick oven mittens when removing the food or turntable from the oven to **PREVENT BURNS**. Because the oven cavity, door, turntable, turntable support, racks, dishes and especially the grill will become very hot.
3. Metal cookware can be used.

During mix cooking some metal utensils may cause arcing when they come in contact with oven walls or accessory racks. To prevent arcing when using a metal tin, place a heat resistant dish (microwave safe glass pie plate, dinner plate) between the tin and the rack.

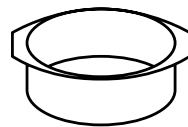

CAKE TIN



PIZZA TRAY

CONVECTION COOKING

1. Use thick oven mittens when removing the food or turntable from the oven to **PREVENT BURNS**. Because the oven cavity, door, turntable, turntable support, racks, dishes and especially bottom heater will become very hot.
2. For best results, preheat to required temperature with the turntable in the oven. Add food after preheating.
3. Metal cookware can be used. Round pizza trays are excellent cooking utensils for cooking.

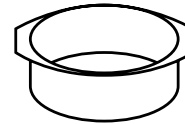

CAKE TIN

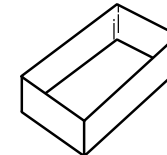

SQUARE DISH



PIZZA TRAY

4. If you are cooking and wish to check the temperature you have programmed, simply press the **CONVEC** pad. The programmed temperature will be displayed as long as **CONVEC** pad is pressed.
5. Do not cook 2 layers of eg. biscuits at the same time.

HELPFUL HINTS

MICROWAVE COOKING

1. ARRANGEMENT

Arrange foods carefully. Place thickest areas toward outside of dish.

Eg. Arrange vegetables in a shallow dish in the following way:

Hard Vegetables around the outside, Soft Vegetables in the centre, Medium Vegetables in-between.



2. TURNING

Foods such as poultry and joints of meat should be turned over after half the cooking time.

3. COVERING

Cover foods in the microwave if you would normally cover the food in your ordinary oven, or to retain moisture. Cover foods such as Vegetables, Casseroles, or when Reheating.

Use to cover foods:

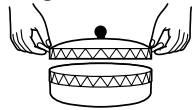

LID



PLASTIC WRAP

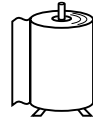

PAPER TOWEL

4. PIERCING

Pierce potatoes, eggs, oysters, tomatoes or any foods with a skin or membrane to allow steam to escape.



TOMATO



EGG

5. SHIELDING

Shield using small pieces of aluminium foil to shield thin areas of meat, fish and poultry or edges of cakes to prevent overcooking.



FISH



CHICKEN

6. STANDING TIME

Standing time is important. After cooking or defrosting ensure adequate standing time. This allows the food to continue cooking or heating. Refer to cooking guides for each menu or according to manufacturers instructions.

7. STIRRING

Stir foods from the outside to the centre of the dish, once or twice during cooking if possible.

Eg. Casseroles and Sauces.



STIR

8. SIZE

Small pieces cook faster than large ones. To speed cooking, cut pieces smaller than 5 cm so microwaves can penetrate to the centre from all sides. For even cooking, make all the pieces the same size.

9. DENSITY

The depth to which microwaves penetrate food varies depending on the food's density. Porous foods like minced beef or mashed potatoes microwave faster than dense ones like steak or whole potatoes.

10. FAT AND BONE

Marbling within meat, or a thin, even layer of fat on a roast, speeds cooking. Large fatty areas or excess drippings in a dish attract energy away from meat, and slows cooking. Centre bones do not affect cooking, but bone on the side of meat conducts heat to the areas next to it.

11. STARTING TEMPERATURE

Frozen or refrigerated food takes longer to heat than food at room temperature. Cooking times in this manual are based on normal storage temperatures. Since rooms, refrigerators and freezers differ in temperature, check for doneness at the minimum time.

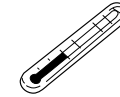

12. QUANTITY

Microwave cooking times are directly related to the amount of food in the oven. Because energy is absorbed by the food itself, one potato or a single piece of chicken cooks rapidly. When the energy is divided among several items, cooking takes more time.

13. CONDENSATION

Condensation is a normal part of microwave cooking. The humidity and moisture in food will influence the amount of condensation in the oven. Generally, covered foods will not cause as much condensation as uncovered foods. Ensure that the ventilation openings are not blocked.

14. GENERAL

Your microwave oven is capable of heating food and beverages very quickly therefore, it is very important that you select the appropriate cooking time and power level for the type and quantity of food to be heated. If you are unsure of the cooking time and power level required, begin with low cooking times and power levels until the food is sufficiently heated evenly throughout.

SHARP **SMART COOKING GUIDES**

CONTENTS

- (1) Smart Cooking Guides Contents
- (2 - 3) Helpful Hints
- (4) Cookware & Utensil Guide
- (5 – 6) Fan Forced Cook Menu Guide
- (7) Convenience Menu Guide
- (8 – 9) Inverter Microwave Cook Menu Guide
- (10 – 33) Recipes

QUICK REFERENCE GUIDE

FEATURE	QUICK OPERATION GUIDE
Defrost e.g. Roast Meat	<p> DEFROST → START <small>x 3</small> <small>+30SEC.</small> </p> <p> Weight [1] [0] [0] → START <small>eg. 1.0kg</small> <small>+30SEC.</small> </p>
Reheat e.g. Beverage 1 Cup	<p> REHEAT → START <small>x 2</small> <small>+30SEC.</small> </p>
Variable Cooking Control	<p>To soften Cream Cheese or Butter for 40 seconds at 330W power level (M•LOW).</p> <p> MICROWAVE WATTAGE → START → [4] [0] → START <small>x 8</small> <small>+30SEC.</small> <small>Cooking Time</small> <small>eg. 40 seconds</small> <small>+30SEC.</small> </p>
Preheat	<p> PREHEAT → [5] → START → [2] [0] [0] [0] → START <small>eg. 170°C</small> <small>170°C</small> <small>+30SEC.</small> <small>Cooking Time</small> <small>eg. 20 minutes</small> <small>+30SEC.</small> </p>
Manual Convection Cooking	<p> FAN FORCED CONVEC. → [6] → [1] [5] [0] [0] → START <small>eg. 180°C</small> <small>180°C</small> <small>Cooking Time</small> <small>eg. 15 minutes</small> <small>+30SEC.</small> </p>
Grill Cooking	<p> GRILL → [1] [5] [0] [0] → START <small>Cooking Time</small> <small>eg. 15 minutes</small> <small>+30SEC.</small> </p>
Combi Cooking	<p> COMBI → START → [1] [5] [0] [0] → START <small>x 1</small> <small>+30SEC.</small> <small>Cooking Time</small> <small>eg. 15 minutes</small> <small>+30SEC.</small> <small>eg. Microwave and Convec.</small> </p>