

omega

OPERATING AND INSTALLATION INSTRUCTIONS
FOR
OMEGA 60CM BUILT-IN PYROLYTIC ELECTRIC OVEN

0061PX

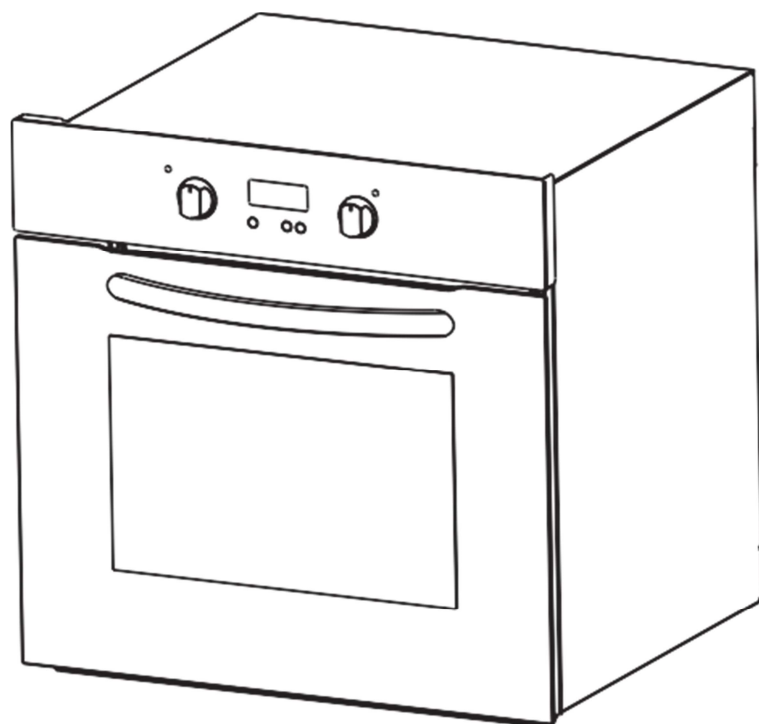

Thank you for introducing our family to yours

At Omega, we understand that cooking, cleaning and washing may not be your favourite things in the world. That's why we created a range of no-nonsense, reliable products that always get the job done for you. With the features you need and nothing you don't. What's more, they're made to fit perfectly into your home life and your wallet.

We aim to simplify any further appliance purchases. When researching our products you will find a range of icons that visually represent our products key features. Visit our website to learn more about these icons and the features and benefits of our products.

You are welcoming an Omega appliance into your place and you can be sure it'll always serve you well.

For important information about your Omega such as warranty registration, online manuals, specifications and catalogues, please visit

www.omegaappliances.com.au/customer (if you are in Australia) or

www.omegaappliances.co.nz/customer (if you are in New Zealand).

Make sure you activate your product warranty on our websites on the links above.

If you want to know more about promotions, to receive cool tips and tailor made content, like us on www.facebook.com/omegaappliances and follow us on www.instagram.com/omegaappliances_au.

We hope you love this product as much as we do!



www.omegaappliances.com.au / www.omegaappliances.co.nz



[omegaappliances](https://www.facebook.com/omegaappliances)



[omegaappliances_au](https://www.instagram.com/omegaappliances_au)

INSTALLATION, OPERATION AND MAINTENANCE INSTRUCTIONS FOR OMEGA BUILT-IN PYROLYTIC ELECTRIC OVEN

OO61PX BUILT-IN ELECTRIC PYROLYTIC OVEN

CONGRATULATIONS

Thank you for choosing one of our many fantastic built in ovens. We are confident that you will now be able to meet your cooking needs. Before you use the oven we strongly recommend that you read though the whole user manual which provides the description of this product and the proper use of its functions.

To avoid the ever-present risks involved with using an electrical appliance it is vital that the oven is installed correctly and that you read the safety instructions carefully to avoid misuse and hazards. It is important that you retain these instructions and your proof of purchase along with any other important documents about this product for future reference.

Due to continual product development, Omega reserves the right to alter specifications or appearances without notice.

CONTENTS

SECTION	PAGE NO.
Important Safety Instructions.....	3
Appliance Details.....	4
Electrical Connections.....	4-5
Installation.....	6-7
Operating Instructions.....	8-15
Cleaning.....	16
Troubleshooting.....	17
Transportation.....	17
Cooking Guides.....	18-19

DISPOSAL INFORMATION

- Most of the packing materials are recyclable. Please dispose of these materials through your local recycling depot or by placing them in appropriate collection containers.
- If you wish to discard this product, please contact your local authorities and ask for the correct method of disposal.

IMPORTANT SAFETY INSTRUCTIONS

IMPORTANT: Read the assembly instruction section and safety precautions of this booklet carefully before removing the contents of this carton.

1. This appliance is not intended for use by persons (including children) with reduced physical, sensory or mental capabilities, or lack of experience or knowledge, unless they have been given supervision or instructions concerning the use of the appliance by a person responsible for their safety. Children should be supervised to insure that they do not play with the appliance.
2. In certain circumstances electrical appliances may be a danger hazard.
3. Do not place heavy objects in or on these appliances, use for storage or let children play/swing from the door. These appliances are designed for cooking food only.
4. This appliance is designed for domestic household use only and for the cooking of domestic food products. Use as a commercial appliance will void the warranty. It should not be used in a marine environment or outdoors.
5. This appliance is supplied with a 15 amp plug. The plug has a large earth terminal that will not fit into a common electrical socket. To install the oven, a special socket is required to be installed by a licensed electrician (if it does not already exist at the point of installation).
6. If the electrical supply cord is damaged, either when being installed or after installation, it must be replaced by the manufacturer, its service centre or similarly a qualified person in order to prevent a hazard.
7. The electrical connection must be accessible after installation. The appliance must be electrically isolated before any maintenance can be performed, which includes changing a lamp.
8. Electrical connection must be made as per local wiring rules and regulations. Do not disconnect the appliance with wet hands or bare feet, and do not disconnect the power cord with extreme force.
9. Always grasp the oven door in the centre of the handle as the areas around the door edges may be hot due to the escape of hot air.
10. Ensure that the kitchen is well ventilated or mechanical ventilation is in use while cooking with this appliance.
11. Do not store or use flammable materials or aerosols near the oven. Items made from aluminium, plastic or plastic film should also be kept away from the appliance, as they may fuse to the surface.
12. Never line the oven bottom with aluminium foil, as the consequent accumulation of heat could compromise the cooking and even damage the enamel.
13. **WARNING** - The oven will become hot during and directly after use. Do not touch any components during this time, as they may be hot and can cause burns. Do not touch the heating elements inside the oven to avoid burns. Children should be kept away. Use heat resistant cooking gloves where possible when moving food and cooking utensils in and out of the oven.
14. Cleaning may only be commenced on the appliance once it has cooled down (best slightly warm). The appliance should be disconnected from the power outlet or turned off at your isolation switch before commencing any cleaning process. Do not use a steam jet or any other high pressure cleaning equipment to clean the appliance. Follow oven cleaner directions if these are being used.
15. Wash all accessories in hot soapy water or in a dishwasher, wipe dry with a paper or cloth towel. If you use your oven for an extended period of time, condensation may form. Dry it using a soft dry cloth.
16. When the appliance is not being used, the knobs must be kept in the 'OFF' position.
17. Where this appliance is installed in a caravan, it shall NOT be used as a space heater.
18. Do not modify this appliance.
19. Do not use harsh abrasive cleaners or sharp metal scrapers to clean the glass oven door glass as it can scratch the surface, which may result in the glass shattering. Clean the glass door using warm damp cloth and dry it with a soft cloth.
20. All cabinetry and materials used in the installation must be able to withstand a minimum temperature of 50°C above the ambient temperature of the room it is located in, whilst in use. Certain types of vinyl or laminate kitchen furniture are particularly prone to heat damage or discolouration at temperatures outside the guidelines given above. Any damage caused by the appliance being installed without adhering to the temperature limits set out above will be the liability of the owner.
21. This appliance must be correctly installed by a suitably qualified person, strictly in accordance with the manufacturer's instructions. Please see the specific section of this booklet that refers to installation.
22. The appliance must be installed and put in operation by an authorised technician under the conditions provided by the manufacturer in this manual. The manufacturer cannot be held responsible for any damage that might occur due to faulty installation.
23. The values indicated on the printed documents found on the product are values obtained in laboratory environment according to relevant standards. These values may vary according to the usage and environment conditions of product.
24. This operating manual has been prepared jointly for multiple models. Some of the specifications explained in the manual, may not be included in your appliance. Pay attention to the explanations with illustrations while reading the manual.

APPLIANCE DETAILS

ELECTRICAL DETAILS:

OVENS: OO61PX

Rated Voltage: 220 to 240V ac 50Hz

Max Rated Inputs: 2600W

Supply Connection: OVENS - 15 A plug

This information can be found on the rating plate (data label) affixed to the inside of the door jamb.

SIZES:

Relevant Sizes:	LENGTH (mm)	WIDTH (mm)	HEIGHT (mm)
External Oven size	595	570	595

ELECTRICAL CONNECTIONS



LOCAL AUTHORITY REQUIREMENTS

Installation is only permitted by a licensed electrician, and carried out according to instructions provided by the manufacturer. Incorrect installation might cause harm and damage which the manufacturer accepts no responsibility.

ELECTRICAL INSTALLATION FOR THE LICENSED ELECTRICIAN

This oven must be connected to a 220-240V 50Hz power supply. It is earthed via the cord and 15A plug.

Before carrying out the connection to the power supply, the voltage rating of the appliance (stamped on the appliance identification plate) must be checked for correspondence to the available mains supply voltage, and the mains electric wiring should be suitable for the oven's power rating (also indicated on the appliance identification plate);

The switched outlet must be connected to a suitable earth wiring, in conformity to current safety regulations.

This appliance must be plugged into a 15A switched outlet. It should not be located above the appliance and no more than 1.25m away from it. The power supply cord must not touch any hot surfaces and must be placed so that its temperature does not exceed 75°C at any point along its length. After having installed the appliance, the switched outlet must always be in an accessible position.

NOTE: For connections to the mains power supply, never use adapters, reductions or multiple power points as these may overheat and catch fire.

The mains terminal block is located on the back of the oven and the terminals are accessible by opening the terminal block cover.

Note: The terminal cover should not be opened when the mains power is still connected to the appliance and never by an unauthorized person.

The electrical safety of this appliance can only be guaranteed if the oven is correctly and efficiently earthed. The manufacturer declines all responsibility for damage resulting from an installation which has not been earthed correctly. The use of adapters, multiple sockets and/or extensions, is not allowed.

OVEN LAMP REPLACEMENT

- The appliance must first be disconnected from the power outlet or turned off at your isolation switch.
- Unscrew the glass cover attached to the lamp holder; anti-clockwise.
- Unscrew the lamp and replace it with another high-temperature lamp with the following characteristics:

Type: E 14

Voltage: AC220V-240V

Wattage: 25W Temperature rating: 300°

- Remount the glass cover and reconnect the appliance to the power supply

NOTE: Should you experience any difficulty please contact your nearest after-sales service centre.

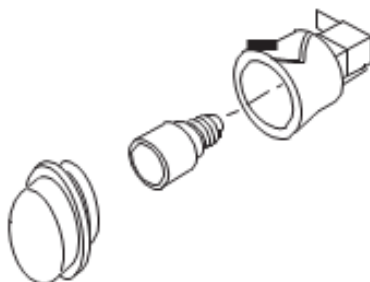

INSTALLATION



The adjacent furniture must be able to withstand a minimum temperature rise of 50°C above the ambient temperature of the room it is located in during periods of use. The power supply to the appliance must be cut off before any adjustments or maintenance work is done on it.

PREPARATION FOR INSTALLATION AND USE

Manufactured with best quality parts and materials, this modern, functional and practical oven will meet your needs in all respects. Make sure to read the manual to obtain successful results so as not to experience any problems in the future. The information given below contains rules that are necessary for correct positioning and service operations. They should be read without fail, especially by the technician who will position the appliance.

CHOOSING A PLACE FOR THE APPLIANCES

There are several factors to consider when choosing a place for your oven. Make sure to take into account our recommendations below in order to prevent any problems and dangerous situations which might arise.

When choosing a place for the oven, attention should be paid to ensure there are no flammable or combustible materials in the close vicinity, such as curtains, oil, cloth etc. which quickly catch fire.

Furniture surrounding the oven or cooktop must be made of materials resistant to temperatures of at least 100 C°.

Required changes to wall cabinets and exhaust fans above a built-in cooktop as well as minimum heights from the oven board are shown below. Accordingly, a range hood should be at a minimum height of 65 cm from the cooktop. If there is no range hood the height should not be less than 70 cm. Refer to the range hood instructions for specific details before installation.

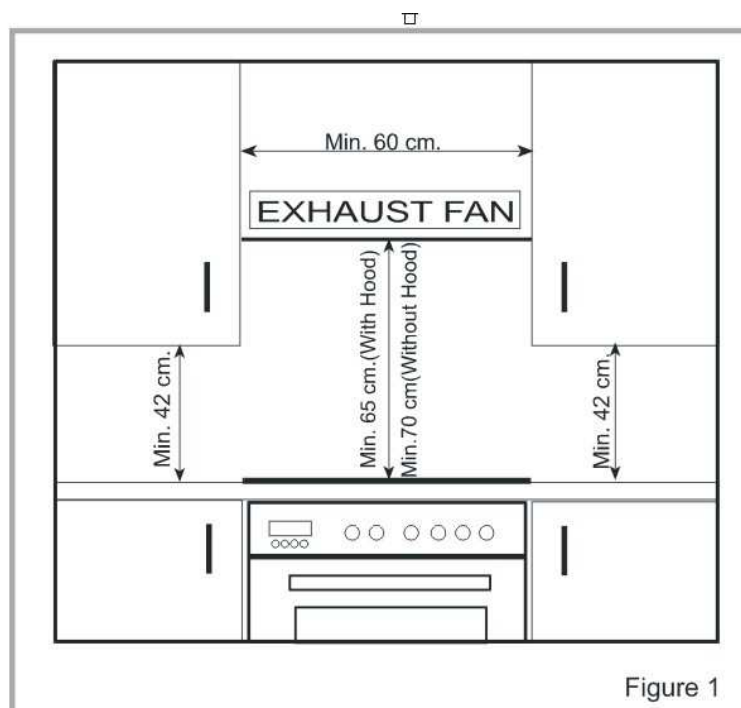

INSTALLATION OF BUILT IN OVEN

Insert the oven into cabinet partly by pushing it forward. Open the oven door and insert 2 screws into the holes on the oven frame. While the product frame touches the wooden surface of the cabinet, tighten the screws. If the oven is installed below a built-in hob, the distance between the worktop and the top panel of the oven must be a minimum of 50mm, and the distance between the worktop and the top of the oven control panel must be a minimum of 25mm.

The dimensions and material of the cabinet in which the oven will be installed must be correct and resistant to increases in temperature. In a correct installation, contact with electrical or insulated parts must be prevented. Insulating parts need to be fitted in a way to ensure that they cannot be removed by using any kind of tool. Installing the appliance in the close vicinity of a refrigerator or a deep-freezer is not recommended as the performance of the above-mentioned appliances will be negatively affected due to emanating heat. After removing your oven from its packaging, be sure that the oven is not damaged. If you suspect any damage to the appliance, do not use it; immediately contact an authorised Service Centre.

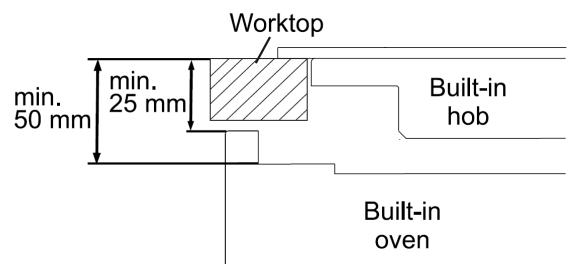
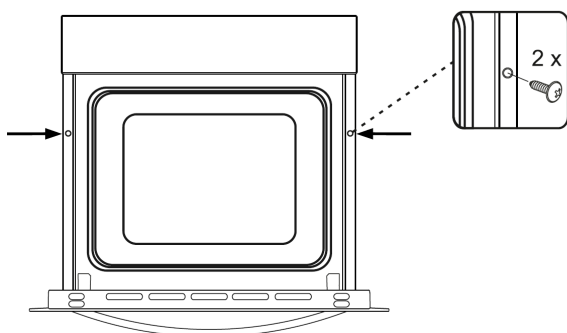
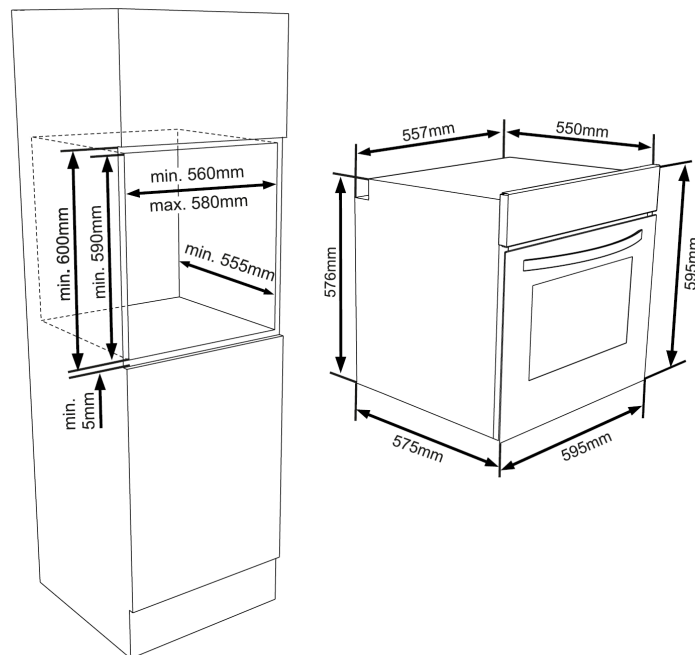
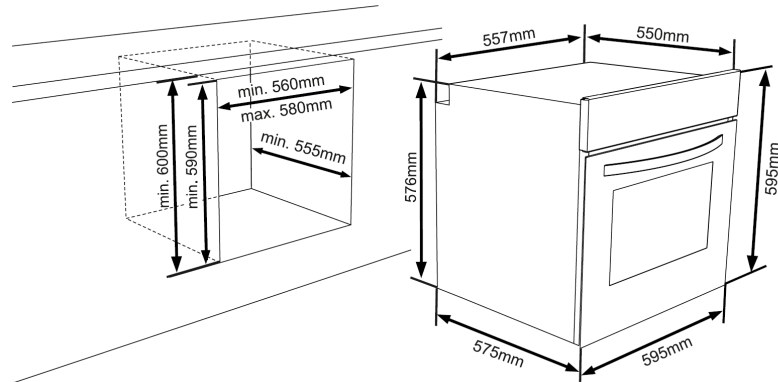

OPERATING INSTRUCTIONS

FRONT VIEW:

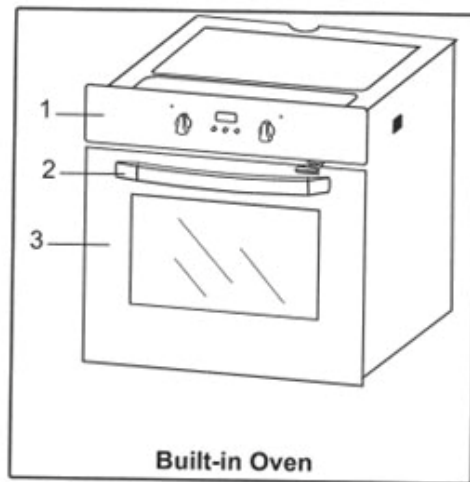

INTERNAL VIEWS:

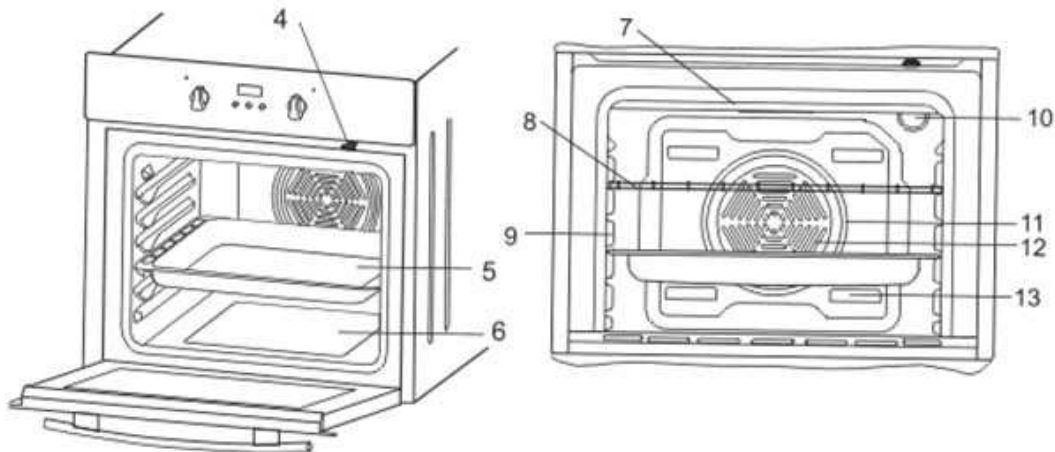

1. Control Panel.
2. Handle.
3. Oven Door.
4. Door Lock.
5. Tray.
6. Bottom Heating Element (under plate).
7. Top Heating Element (above plate).
8. Wire Grill (2).
9. Racks/Shelf Holders.
10. Oven Light.
11. Turbo Heating Element.
12. Fan (behind plate).
13. Air Outlet Shutters.

When you first run your oven a certain smell will be emanated arising from the insulation materials and the heater elements. For this reason, before using your oven, run it empty at maximum temperature for 45 minutes. At the same time you need to properly ventilate the environment in which the oven is installed.

In order to cook in your oven, the oven function and temperature setting controls need to be adjusted and the oven timer, if available, needs to be programmed. Otherwise, the oven will not operate.

Unplug your appliance when it is not in use.

Protect your appliance from atmospheric effects. Do not leave it under the effects of the sun, rain, snow, dust etc.

ENERGY SAVING

Choose cookware of an appropriate size. Using a lid will reduce cooking times. Minimize the amount of liquid or fat to reduce cooking times. Oven door should not be opened often during cooking period.

CONTROLS

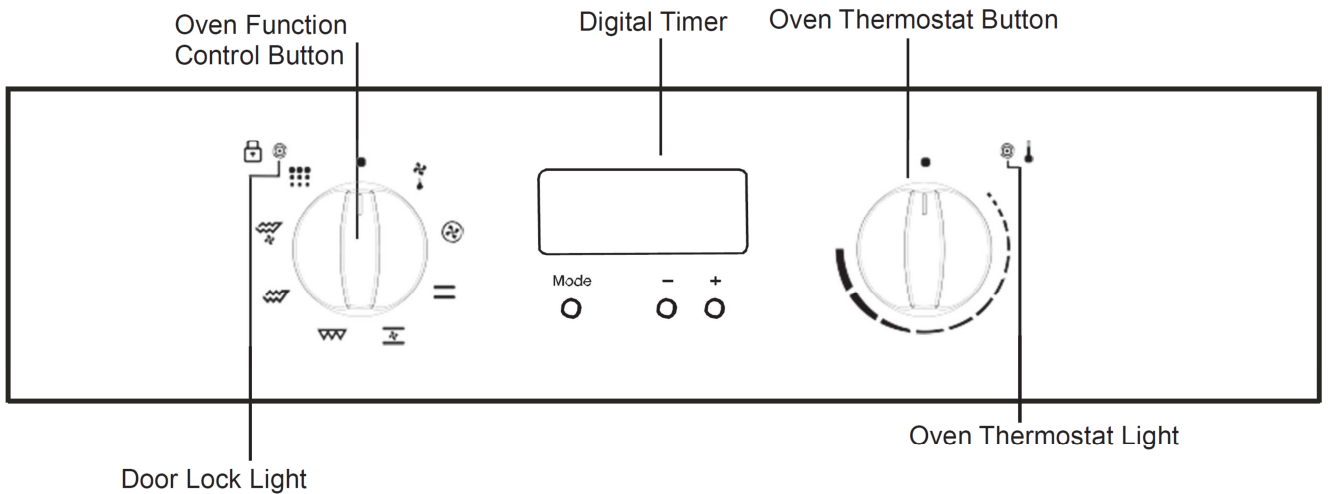

OVEN FUNCTION/WARNING LIGHT CONTROL

The oven function control knob is used to select the different functions. Each is explained in detail further in the manual. To select a function, turn the control knob to the desired oven function and then set the temperature with the thermostat control.

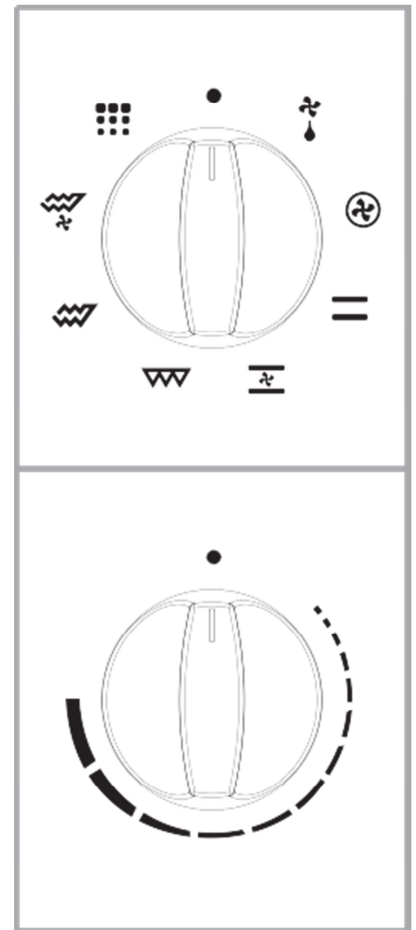









OVEN THERMOSTAT CONTROL

The oven thermostat control is used to select the desired temperature for cooking. When the temperature inside your oven reaches the value set, the thermostat will cut the circuit and the thermostat light will go off. When the temperature falls below the set value, the thermostat will again be turned on alongside the thermostat light. It is normal for this to occur during the cooking process, particularly when the door has been opened.

NOTE: The temperature setting can be checked while the oven is operating by either pressing the "+" or "-" buttons (without first pressing the mode button), or slightly adjusting the temperature control.

OVEN FUNCTION CONTROL CHART

	DEFROST THE FAN WILL SWITCH ON ALONG WITH THE OVEN LIGHTS TO PERFORM THE DEFROST FUNCTION.
	FAN FORCED THE REAR HEATING ELEMENT AND FAN WILL SWITCH ON, ALONG WITH THE OVEN LIGHTS AND THE OVEN'S THERMOSTAT.
	CONVENTIONAL THE LOWER & UPPER HEATING ELEMENTS WILL SWITCH ON, ALONG WITH THE OVEN LIGHTS AND THE OVEN'S THERMOSTAT.
	FAN ASSIST THE LOWER AND UPPER HEATING ELEMENTS, AND FAN WILL SWITCH ON, ALONG WITH THE OVEN LIGHTS AND THE OVEN'S THERMOSTAT.
	MID-GRILL THE UPPER MID-GRILL HEATING ELEMENT WILL SWITCH ON, ALONG WITH THE OVEN LIGHTS AND THE OVEN'S THERMOSTAT.
	MAXI-GRILL BOTH UPPER HEATING ELEMENTS WILL SWITCH ON, ALONG WITH THE OVEN LIGHTS AND THE OVEN'S THERMOSTAT.
	MAXI-GRILL WITH FAN BOTH UPPER HEATING ELEMENTS AND FAN WILL SWITCH ON, ALONG WITH THE OVEN LIGHTS AND THE OVEN'S THERMOSTAT.
	PYROLYTIC CLEANING THE DOOR LOCK WILL ACTIVATE AND THE OVEN WILL HEAT UP TO BURN OFF FOOD RESIDUES. WHEN THE CLEANING CYCLE HAS FINISHED THE COOLING FAN WILL TURN ON TO COOL THE OVEN DOWN. THE FUNCTION IS FINISHED WHEN THE DOOR UNLOCKS.

Note: Oven shelves are numbered from 9 at the top down to 1 at the bottom.

During heated oven functions a cooling fan in the top of the oven will operate in order to cool down the oven door and kitchen cabinet as well as reducing condensation in the oven. There will then be a slight release of warm air from the top of the closed oven door. This is not a leak in heat from the oven cavity.

OVEN FUNCTION CONTROLS



Defrost Function:

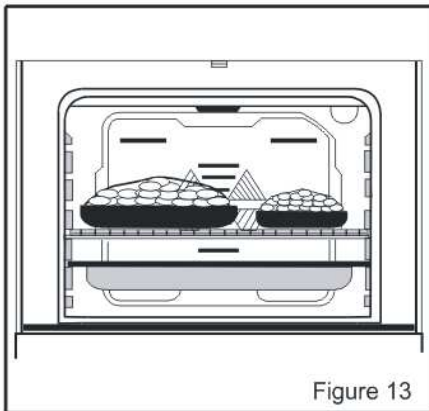

You can start the defrost operation by putting the frozen food into oven and bringing the function control knob to the indicated mark. This function will not cook/bake the food; it only helps to defrost it within a short time.

Put the food to be defrosted on the wire rack that you will place on the third rack support from the bottom (Figure 13). To collect the water that accumulates due to the melting ice, insert an oven tray onto a lower rack. This function is perfect for finishing off the defrosting process for frozen food that has been in the refrigerator from the evening before and may not be completely thawed out.



Fan Forced Function:

This Fan Forced function uses the turbo heater (located in the back of the oven) to evenly disperse the heat in the oven. This function is suitable for cooking multiple dishes on various oven shelves. Adjust the function control knob so it indicates the Fan Forced function symbol. Adjust the thermostat control knob of your oven to a temperature recommended on the cooking table for the cooking operation you wish to perform.

Preheating of the oven for about 10 minutes is recommended. Place the food in a suitable container, then place into oven and cook for the required time.

If you are going to cook using two trays at the same time, while adjusting the cooking temperature, select the temperature that is the lowest among the levels suitable for your food of choice, as shown in the table on page 18. Cooking with two trays requires additional cooking time compared to cooking with one tray. Usually, the food on each tray does not finish at the same time so you may need to take the tray of cooked food out of the oven, and continue the cooking operation for the remaining tray. After cooking, turn off the oven function and temperature control knobs and cancel the timer program if in use. Take the cooked food out of the oven and place it on a safe heatproof surface. As the oven will be hot, work near with caution and keep children away from the cooling oven.



Conventional Cooking Function

The Conventional function allows heat to radiate evenly from the lower and upper elements into the oven ensuring even cooking of both sides of the food. Adjust the function control so it indicates the conventional Cooking function symbol. Adjust the thermostat control knob of your oven to a temperature recommended on the cooking table for the cooking operation you wish to perform. Preheating of the oven for about 10 minutes is recommended. Place food in a suitable container, then place into oven and cook for the recommended time. This function is preferred for making cakes (cupcakes, other cakes and sponges), biscuits, pastry, baked pasta (e.g. lasagne), casseroles and moist dishes, roasts and oven chips.

After cooking, turn off the oven function and temperature control knobs and cancel the timer program if in use. Take the cooked food out of the oven and place it in a safe heatproof surface. As the oven will be hot, work near with caution and keep children away from the cooling oven.

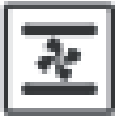

Fan Assist Function:

This is the function where the air coming from the lower and upper heating elements is circulated into the oven by the fan motor and blade. Adjust the function control knob so it indicates the Fan Assist Function symbol and adjust the oven timer to the recommended time for cooking. Adjust the thermostat control knob to the temperature required on the cooking table for the Fan Assist Function and preheat oven for 10 minutes. Based on the convection function, this combination of features increases the effectiveness of the thermal radiation of the heating elements through forced air circulation of the heat throughout the oven. This helps prevent food from burning on the surface, allowing the heat to penetrate into the food. Food baked using this function such as pastry often brown faster than on the conventional function alone.

After cooking, turn off the oven function and temperature control knobs and cancel the timer program if in use. Take the cooked food out of the oven and place it on a safe heatproof surface. As the oven will be hot, work near with caution and keep children away from the cooling oven.



Mid-Grill Function:

This function is used for grilling. Adjust the function control knob so it indicates the Mid-Grill function symbol and adjust the oven timer to the recommended time for cooking. Set the oven's thermostat control knob to the required temperature. After a preheating period of 10 minutes, put your food into the oven. For grilling, put the food on the grill rack and sit into the tray. Place the tray on the highest shelf (9). Placing the rack within the oven tray provided will ensure that any marinade, fat or oil dropping from the food will be collected. When grilling, the oven door must be closed. On this function, the middle heating elements/coils of the grill operate.

This setting is ideal for toasting bread, cheese melts and melting cheese topped dishes or finishing off a dish to lightly brown on the surface. Also used for herb and garlic bread.

After cooking, turn off the oven function and temperature control knobs and cancel the timer program if in use. Take the cooked food out of the oven and place it on a safe heatproof surface. As the oven will be hot, work near with caution and keep children away from the cooling oven.



Maxi-Grill Function:

This function is used for faster grilling and for grills with a lot of food. Adjust the function control knob so it indicates the Maxi-Grill function symbol. Set the oven's thermostat control knob to the required temperature. After a preheating period of 10 minutes, put your food into the oven. For grilling, put the food on the grill rack and sit into the tray. Place the tray on the highest shelf (9). Placing the rack within the oven tray provided will ensure that any marinade, fat or oil dropping from the food will be collected. When grilling, the oven door must be closed. On this function, all of the heating elements/coils of the grill operate.

The higher grill temperature and function is ideal for cooking and browning meat (such as lamb or pork chops and cutlets), chicken and seafood (such as fish fillets, cutlets, tuna steaks or Atlantic salmon). This setting is also good for browning fruit crumbles or crumb topped dishes.

After cooking, turn off the oven function, temperature control knobs and cancel the timer program if in use. Take the cooked food out of the oven and place it on a safe heatproof surface. As the oven will be hot, work near with caution and keep children away from the cooling oven.



Maxi-Grill with Fan Function:

This function will ensure complete, fast and all over grilling by working the fan, the grill and the upper heating element at the same time. Adjust the function control knob so it indicates the Maxi-Grill with Fan function symbol and adjust the oven timer to the recommended time for cooking. Set the oven's thermostat control to the required temperature. After a preheating period of 10 minutes, put your food into the oven. For grilling, put the food on the grill rack and sit into the tray. Place the tray on the highest shelf (9). Placing the rack within the oven tray provided will ensure that any marinade, fat or oil dropping from the food will be collected. When grilling, the oven door must be closed.

The Maxi-grill with fan function is ideal for cooking food to achieve a crispy skin (such as chicken thigh or breast with the skin on) and lightly browning meat such as lamb and seafood.

After cooking, turn off the oven function and temperature control knobs and cancel the timer program if in use. Take the cooked food out of the oven and place it on a safe heatproof surface. As the oven will be hot, work near with caution and keep children away from the cooling oven.



Pyrolytic Cleaning Function:

This function is for cleaning the oven & not for cooking. Before activating the pyrolytic cleaning function, remove all excessive spillage and make sure the oven is empty (remove racks, trays etc) as the cleaning process could damage them. Ensure the door is closed before starting. The door will automatically lock during the process. When the function is running, do not use a hob installed above the oven as the excess heat may damage both appliances. During the process, the handle may get hot – keep children away until cool. After the process has finished, the timer display will show the current time.

The pyrolytic cleaning process works by heating the oven to temperatures up to 475°C, burning food residues off the specially designed temperature resistant enamel coating. At the end of the heating process, the cooling fan turns on to cool the oven down, after which the oven door lock disengages. Once it is cooled, the residue can be wiped out with a wet sponge (this should be done after every cleaning cycle). As the heat burns the food residues, some burning smells and smoke can be generated from the oven. It is recommended that the room be cut off from the rest of the house, all children & animals removed and the room be well ventilated (open windows and/or operating range hoods).

The pyrolytic cleaning function is displayed with a "P" and a count-down from 90 minutes (1:30).

NOTE: Running a cooking function before the oven has cooled can cause the lamp to fail and damage your appliance; always allow the oven to fully finish the cleaning function before any adjustments are made to the settings.

USING THE DIGITAL TIMER



Time of Day Adjustment:

The time must be adjusted before starting to use the oven. Following the connection of the power supply to the oven, the display will begin to flash. Leave the oven function control at "off" and then press either the "+" or "-" button (set to manual mode). Press the "+" or "-" buttons to set the correct time. Once correct, leave for 5 seconds to set.

As the displayed time will be reset in the event of a power failure or power loss, the time adjustment operation will have to be performed again before the oven will work.

Note: that the time can only be reset after the power has been reset.

Minute Minder:

This function can be used to receive an audible warning after a pre-set time. It is used as a reminder and does not affect the cooking functions.

Press the MODE button under the display. The symbol  and 0:00 will appear on the screen. Adjust the desired time period (HH:MM – up to 23.59) for the warning by using "+" or "-" buttons. Shortly after the completion of the adjustment, the current days' time will be displayed confirming, the minute minder has been set. The time can be adjusted if needed later by pressing the mode button again, and then with the "+" and "-" buttons.

When the set time is up, the timer gives an audible warning and the symbol  turns off. Pressing either the "+" or "-" button will stop the audible warning.

The oven will not be turned off with this audible warning function.



There are 3 different auditable warning levels available. To choose between them, start with the timer showing the time of day. Press the MODE button 3 times while the function select knob is off until "L3" is displayed. Press the "-" or "+" buttons to adjust the sound level, and release to set. This needs to be reset in the event of a power failure.

Semi-Automatic Time Adjustment According to Cooking Time:

This function is used to cook for a set duration. The food to be cooked is put into the oven and the oven is adjusted with the control knobs to the desired cooking function and temperature depending on the food/dish to be cooked (the manual operation symbol  will be lit). Press the MODE button twice, until "dur" appears on the timer screen and wait 5 seconds for the time display to appear – and the symbol (A) will begin to flash. Adjust the cooking period or time for the food you wish to cook by using the "+" or "-" buttons while the timer is in this position. Five seconds after the adjustment operation is completed, the current day's time will appear again on the screen and the symbol "A" will continue to be lit on the screen. The oven will then continue to operate on your chosen function. To cancel and return the oven to manual operation, repeat the above and set the time to zero.

A cooking period/time between 0 and 10 hours can be set. At the completion of the programmed cooking time, the timer will stop the oven operation and give an audible warning and "A" will turn off. Pressing any button of the timer will end the audible warning and the oven will return to manual use (the manual operation symbol  will be lit). This function is perfect for setting a cooking time remaining for food that is already cooking in the oven (e.g. – 30 minutes) prior to leaving the house or going into the garden as examples. When this time is up, the oven will stop operating and the internal oven light will go out. Only after adjusting the oven function and thermostat control knobs to their off (0) positions will the oven be fully turned off.

Semi-Automatic Programming According to Finish Time:

This function is used to cook according to desired finishing time. The food to be cooked is put into the oven and the oven is adjusted to the desired cooking function and temperature depending on the food/dish to be cooked (the manual operation symbol  will be lit). Next keep pressing on the MODE button (three times) until "end" appears on the timer screen, and the timer display starts to flash. Adjust the finishing time for the food you wish to cook, by using the "+" and "-" buttons while the timer is in this position. Five seconds after the adjustment operation is completed, the current days' time will appear again on the screen and the symbols "A" and  will be continuously lit on the screen. The oven will operate on your chosen function.

You can set a time which can be up to 10 hours after the current day's time. At the completion of the set duration, the timer will stop the oven and give audible warning. Also the symbol "A" will begin to flash on the screen and the symbol  will turn off. After adjusting the oven function and thermostat control knobs to their off (0) positions, pressing any button of the timer will end the audible warning and the timer will return to a manual use function.

This function is perfect for setting a cooking completion "time of day" for food that is already cooking in the oven (e.g. – Finish at 5.00PM) prior to leaving the house or going into the garden as examples. When this time is up the oven will stop operating and the internal oven light will go out. Only after adjusting the oven function and thermostat control knobs to their off (0) positions will the oven be fully turned off.

Full- Automatic Programming:

This function is used to cook for a set duration, starting after a pre-set delay. The food to be cooked is put into the oven and the oven is adjusted to the desired cooking function and temperature depending on the food/dish to be cooked.

First Step, Set Cooking Duration: Repeat the procedure for setting the Semi-Automatic Time Adjustment According to Cooking Time, starting with pressing the MODE button twice, until "dur" appears on the timer screen. The length of time set will be the cooking time. Note that the oven is actually cooking at this point. A cooking period between the time range of 0 and 10 hours can be set.

Second Step, Cooking Start Time: Keep pressing the MODE button again until "END" appears on the timer screen. When this happens, the symbol "A" and the current days' time will be lit. Adjust the finishing time for the food to be cooked by using the "+" and "-" buttons while the timer is in this position. At this point the oven turns off (it is in the delay period). Shortly after the adjustment operation is completed, the current day's time will appear again on the screen and the symbol "A" will be continuously light on the screen (the  will stay off until the delay period has expired). The maximum time that can be set is 23 hours, 59 minutes. It is recommended for food safety that food is not placed into the oven more than 2 hours prior to the start time.

The oven start time can be calculated by deducting the cooking period from the set finishing time, and will stop at the set finishing time.

Once the delay period has finished, the oven will turn on ( will be lit) and will continue to run (as above) for the cooking period.

At the completion of the set duration, the timer will stop the oven and give audible warning. Also the symbol "A" will begin to flash on the screen and the  symbol will turn off. After adjusting the oven function and thermostat control knobs to their off (0) positions, pressing any button of the timer will end the audible warning and the timer will return to a manual use function.

This function is perfect for setting a cooking time to begin when you are not at home or around to turn the oven on. Food to be cooked is placed into the oven for example at 3.00PM to begin cooking at 4.00PM and to complete cooking at 5.30PM before you get home at say 6.00PM. When this time is up the oven will stop operating and the internal oven light will go out. Only after adjusting the oven function and thermostat control knobs to their off (0) positions will the oven be turned off.

ACCESSORIES

It is recommended that you use the containers indicated depending on the food you will cook in your oven. You can also use glass containers, cake pans and special oven trays suitable for use in your oven (available in kitchenware shops). Pay attention to the information given by the supplier for use of this cookware. The information given below should be implemented for enamelled containers.

If the food to be cooked does not completely cover the oven tray, if the food is taken out of the deep-freezer or if the tray is used to collect the dripping juices of the foods during the grill operation, deformation might be observed on the tray over time due to high temperatures forming during the cooking/baking operation. This is a normal, physical state that results during the heat transfer. Do not leave a glass tray or container in a cold environment immediately after cooking in them. Do not place them on cold and wet surfaces. Ensure that they slowly cool off by placing them on a dry piece of cloth or wooden board, otherwise, the glass tray or container might break. If you are going to use your oven to grill, we recommend using the grill rack on the tray, supplied together with your product. This way, splattering and dripping oils will not make the oven interior dirty. If you are going to use the large wire oven rack/grill, insert a tray into one of the lower racks to collect fat or oil. To make cleaning easier, add some water into this tray. In a grilling operation, use the shelf in position 8 or 9.

WIRE GRIDS AND TRAYS

Each wire grid and tray comes with a built-in safety feature to help minimise them being accidentally pulled fully out. This comes in the way as a “step”, positioned partway in from the rear of the wire grid or tray.

To fit them into the oven, push the wire grid or tray part way into the oven until the step “catches”, then angle the part over the step & fully insert. To remove, repeat the process in reverse.

WARNING: Accessible parts may become hot when the grill is in use. Children should be kept away.

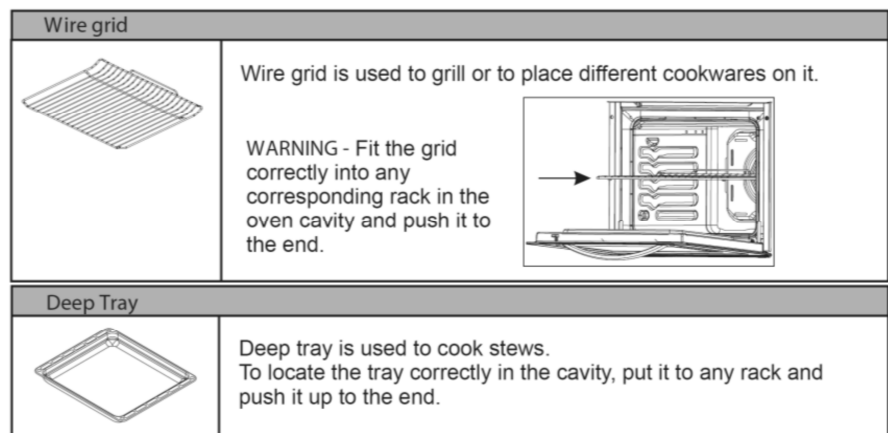

CLEANING



NOTE: Cleaning and maintenance operations must only be carried out when the oven is cool.

The appliance should be disconnected from the power outlet or turned off at your isolation switch before commencing any cleaning process.

Cleaning the oven exterior:

Before starting to clean your oven, be sure that all control buttons are off and your appliance has cooled. Unplug the appliance.

Do not use cleaning materials containing particles that might scratch the enamelled and painted parts of your oven. Use cream cleaners or liquid cleaners, which do not contain particles. As these cleaners may damage the surfaces, do not use caustic creams, abrasive cleaning powders, rough wire wool or hard tools. In the event of any excess liquids spilling over your oven surface during cleaning, clean up immediately so as to prevent possible damage to the enamel or metal surface. Do not use steam cleaners for cleaning the oven.

Cleaning the interior of the oven:

Make sure to unplug the oven before starting to clean it. You will obtain best results if you clean the oven interior while the oven is slightly warm (the oven should not be operating). Wipe your oven with a soft piece of cloth (e.g. dish cloth) dampened with warm soapy water after each use, rinse cloth in warm water then wipe oven again and finish by wiping with a dry cloth. It is also recommended to wipe clean the oven door and rubber seal. For a complete cleaning process, use dry and powder type oven cleaners, following the oven cleaning product's instructions.

TROUBLESHOOTING

If the oven does not operate:

- The oven may be unplugged from the power source or switched off at the power source.
- The household fuse has blown or household power supply is off.
- The Timer (if available) may not be set correctly.

If the oven does not heat:

- The heat may not be set correctly with the oven's temperature setting.

If the interior lighting lamp does not light:

- The lamps are defective. If they are defective, you can change them following the instructions within this manual.

Cooking (if lower-upper part does not cook equally):

- Control the shelf locations, cooking period and heat values according to the manual.

Unit smoking when first used:

- This is a result of protective oils being removed and is to be expected with a first use.

Clock Flashing on Display

- Power failure or interruption

If you have any further problems with your product, please call your Authorised Service Centre.

TRANSPORTATION

Keep the original carton of the product and use this packaging if the item needs to be transported. Follow the transport signs on the carton.

Place paper between the upper cover and cooking panel, cover the upper cover and tape to the side surfaces of oven.

Tape cardboard or paper onto the inside face of the glass as it will be susceptible to damage from the trays. Use cardboard covers for the wire grill and trays in your oven. Also tape the oven's covers to the side walls.

If the original carton is unavailable, take measures to protect the external surfaces (glass and painted surfaces) of oven against possible blows, as well as the above.

COOKING GUIDES

- For optimum cooking keep edges of baking dishes and pans at least 4cm from the sides of the oven. This allows free heat circulation and ensures even cooking.
- Where possible remove large cuts of meat 1kg or over from the fridge 1 hour prior to cooking. Allow, to stand covered and away from direct sun/heat. This process will take the “chill” of the fridge away from the food and assist in more even cooking.

Oven Shelf Location

Your Omega oven has five positions of racks for the oven shelves to be positioned depending on your choice of cooking function and size of roasting dishes or containers. These are numbered from 1 (the lowest shelf position) to 5 (the highest shelf position). See diagram in oven manual.

To obtain maximum space above and below the shelves, it is recommended that you position trays and dishes in the following way:

- When using only 1 shelf, use position/rack 4 or 5 (That's oven shelf position).
- When using 2 shelves, use position/rack 2 and 7.

Cooking Pizza

For the best results when cooking pizza use the Fan forced with Lower Heat Element function. Preheat the oven for at least 10 minutes.

- Use a non-stick pizza pan, ideally one with holes in the base specifically for pizza cooking.
- Do not open the oven door frequently while the pizza is cooking.
- If the pizza has a lot of toppings (three or four), it is recommended that the mozzarella cheese be placed on top halfway through the cooking process. Remember the best pizzas are made with a less is best method when choosing the topping ingredients.
- Check the base is crispy by lifting the pizza pan from the oven with a heatproof glove and lifting the pizza with an oven slide to look at the pizza base. Return to oven if further cooking is required.

Roasting Meat, Cooking Chicken and Fish

- Ideally, meat should be at least 1Kg or more when roasting in order to prevent it from drying out.
- When cooking white meat, poultry and fish, use temperature settings (180°C-220°C).
- For red meat that should be well done on the outside while tender and juicy on the inside, it is a good idea to start with a high temperature setting (200°C-220°C) for a short time, then turn the oven down afterwards and finish off.
- When larger cuts of meat, poultry or fish have finished cooking, ideally remove the food from the oven and cover with foil and stand for 10-20 minutes (depending on size). This will help retain the juices when the meat is carved.
- When cooking large whole fish (1kg or larger) it is recommended that the flesh be scored or slashed 2- 3 times on either side to assist in more even cooking. To do this cut into the thick fish flesh behind the head through to the bone. These scored areas also allow you to check easily to see if the fish is cooked.
- It is a good idea to either measure the inside of your oven for width and either write this down in a book you may have with you when shopping or you can cut a piece of string the oven width, this makes it easier to know if your fish will fit into the oven. Looks can be deceiving and the fish looks so much better whole with its head and tail. If it doesn't fit you will probably need to remove the head prior to baking.

Grilling

Cooking times may vary according to the nature of the foods, their homogeneity and their volume. When cooking a certain food for the first time, it is advisable to choose the lowest temperature and then increase temperature as required.

Cakes and Baking

Organize the oven shelves while the oven is cold and before preparing a recipe. When baking follow the directions in the recipe however if in doubt as a general rule the food (e.g. cake) is positioned on a shelf that will have the top of the cake surface as near to the centre of the oven as possible.

- Preheat oven before preparing the cake or baked items as some baked food does not like to sit waiting for the oven to reach the required temperature. For best results the baked food should go straight into the preheated oven at the correct temperature.
- Use kitchen baking paper to line cake tins and baking trays for cookies and roast vegetables such as pumpkin.
- When making cakes have eggs at room temperature.
- When making sponge cakes don't tap the beaters on the side of the bowl when the beating is complete as this will knock out precious air you have just spent time adding. Remove the beaters from the hand mixer and tap them over the edge of your open palm to knock any remaining cake mix into the bowl below.

Pavlova and Meringues

- Eggs should be at room temperature.
- Ensure that the bowl and beaters to be used are super clean and have no grease, oil or fat on them as this will retard the beating and peak forming process.
- It is a good idea to crack the eggs to be used one at a time over a small bowl to separate the egg yolks and whites that way if a yolk does break it will not end up in your main bowl of egg whites.
- When making pavlova or meringues don't tap the beaters on the side of the bowl when the beating is complete as this will knock out precious air you have just spent time adding. Remove the beaters from the hand mixer and tap them over the edge of your open palm to knock any remaining mix into the bowl below.
- Line baking trays with kitchen baking paper.
- When they are cooked, remove the tray from the oven and use a very flat spatula to loosen the food from the baking paper. Return the Pavlova or meringues to the oven and allow to stand overnight or until the oven is cold for best results.

Think about using the remaining egg yolks to make homemade mayonnaise.

Omega products are distributed in
Australia by Shriro Australia Pty Ltd.
Locked Bag 5002, Kingsgrove NSW 2208
Phone: 1300 795 572 Fax: (02) 9415 5525
Email: service@shriro.com.au
Web: www.omegaappliances.com.au