

omega

INSTRUCTION MANUAL FOR OMEGA
MICROWAVE OVEN

OM30CX

Thank you for introducing our family to yours

At Omega, we understand that cooking, cleaning and washing may not be your favourite things in the world. That's why we created a range of no-nonsense, reliable products that always get the job done for you. With the features you need and nothing you don't. What's more, they're made to fit perfectly into your home life and your wallet.

We aim to simplify any further appliance purchases. When researching our products you will find a range of icons that visually represent our products key features. Visit our website to learn more about these icons and the features and benefits of our products.

You are welcoming an Omega appliance into your place and you can be sure it'll always serve you well.

For important information about your Omega such as warranty registration, online manuals, specifications and catalogues, please visit

www.omegaappliances.com.au/customer (if you are in Australia) or

www.omegaappliances.co.nz/customer (if you are in New Zealand).

Make sure you activate your product warranty on our websites on the links above.

If you want to know more about promotions, to receive cool tips and tailor made content, like us on www.facebook.com/omegaappliances and follow us on www.instagram.com/omegaappliances_au.

We hope you love this product as much as we do!



www.omegaappliances.com.au / www.omegaappliances.co.nz



[omegaappliances](https://www.facebook.com/omegaappliances)



[omegaappliances_au](https://www.instagram.com/omegaappliances_au)

READ THE INSTRUCTION BOOKLET BEFORE INSTALLING AND USING THE APPLIANCE.

It is important that you retain these instructions, proof of purchase as well as other important documents about this product for future reference.

The manufacturer will not be responsible for any damage to property or to persons caused by incorrect installation or improper use of the appliance.

Due to continual product development, Omega reserves the right to alter specifications and appearances without notice.

CONTENTS

IMPORTANT SAFETY WARNINGS	1-2
UTENSILS IN THE MICROWAVE	3
PRODUCT DETAILS	4
SETTING UP YOUR OVEN.....	4
INSTALLATION	5
OPERATING INSTRUCTIONS	6-9
MAINTENANCE AND CLEANING	10
TROUBLESHOOTING.....	10
WARRANTY	11

DISPOSAL INFORMATION

- Most of the packaging materials are recyclable. Please dispose of these materials through your local recycling depot or by placing them into appropriate collection containers.
- If you wish to discard this product, please contact your local authorities and ask for the correct method of disposal.

IMPORTANT SAFETY WARNINGS

To reduce the risk of fire, electric shock, injury to persons or exposure to excessive microwave oven energy when using your appliance, follow basic precautions, including the following:

1. **WARNING:** Liquids and other foods must not be heated in sealed containers since they are liable to explode.
2. **WARNING:** It is hazardous for anyone other than a competent person to carry out any service or repair operation that involves the removal of a cover which gives protection against exposure to microwave energy.
3. The appliance is not intended for use by persons (including children) with reduced physical, sensory or mental capabilities, or lack of experience and knowledge, unless they have been given supervised or instruction concerning use of the appliance by a responsible person for their safety.
4. Keep the appliance and its cord out of reach of children.
5. Only use utensils suitable for use in microwave ovens.
6. The oven should be cleaned regularly and any food deposits should be removed.
7. Read and follow the specific precautions to avoid possible exposure to excessive microwave energy.
8. When heating food in plastic or paper containers, keep an eye on the oven due to the possibility of ignition.
9. If smoke is emitted, switch off or unplug the appliance and keep the door closed in order to stifle any flames.
10. Do not overcook food.
11. Do not use the oven cavity for storage purposes. Do not store items, such as bread, cookies, etc. inside the oven.
12. Remove wire twist-ties and metal handles from paper or plastic containers/bags before placing them in the oven.
13. Install or locate this oven only in accordance with the installation instructions provided.
14. Eggs in the shell and whole hard-boiled eggs should not be heated in microwave ovens since they may explode, even after microwave heating has ended.
15. This appliance is intended to be used in household and similar applications such as:
 - staff kitchen areas in shops, offices and other working environments;
 - by clients in hotels, motels and other residential type environments;
 - farm houses;
 - bed and breakfast type environments.
16. If the supply cord is damaged, it must be replaced by the manufacturer, its service agent or similarly qualified persons in order to avoid a hazard.
17. Do not store or use this appliance outdoors.
18. Do not use this oven near water, in a wet basement or near a swimming pool.
19. The temperature of accessible surfaces may be high when the appliance is operating. The surfaces are liable to get hot during use. Keep cord away from heated surface, and do not cover any vents on the oven.
20. Do not let cord hang over edge of table or counter.
21. Failure to maintain the oven in a clean condition could lead to deterioration of the surface that could adversely affect the life of the appliance and possibly result in a hazardous situation.
22. The contents of feeding bottles and baby food jars shall be stirred or shaken and the temperature checked before consumption, in order to avoid burns.
23. Microwave heating of beverages can result in delayed eruptive boiling. Therefore, care must be taken when handling the container.
24. Young children should be supervised to ensure that they do not play with the appliance.
25. The appliances are not intended to be operated by means of an external timer or separate remote-control system.
26. Accessible parts may become hot during use. Young children should be kept away.

IMPORTANT SAFETY WARNINGS

27. Steam cleaners are not to be used.
28. During use the appliance becomes hot. Care should be taken to avoid touching heating elements inside the oven.
29. Only use the temperature probe recommended for this oven.(for ovens provided with a facility to use a temperature-sensing probe.)
30. **WARNING:** The appliance and its accessible parts become hot during use. Care should be taken to avoid touching heating elements. Children shall be kept away unless continuously supervised.
31. The microwave oven must be operated with the decorative door open (for ovens with a decorative door.)
32. The rear surface of appliance shall be placed against a wall.
33. The microwave oven shall not be placed in a cabinet unless it has been tested in a cabinet.
34. **WARNING:** Only allow children to use the oven without supervision when adequate instructions have been given so that the child is able to use the oven in a safe way and understands the hazards of improper use.

PRECAUTIONS TO AVOID POSSIBLE EXPOSURE TO EXCESSIVE MICROWAVE ENERGY

1. Do not attempt to operate this oven with the door open since this can result in harmful exposure to microwave energy. It is important not to break or tamper with the safety interlocks.
2. Do not place any object between the oven front face and the door or allow soil or cleaner residue to accumulate on sealing surfaces.
3. **WARNING:** If the door or door seals are damaged, the oven must not be operated until it has been repaired by a competent person.
4. If the apparatus is not maintained in a good state of cleanliness, its surface could be degraded and affect the lifespan of the apparatus and lead to a dangerous situation.

DANGER: Electric Shock Hazard

Touching some of the internal components can cause serious personal injury or death. Do not disassemble this appliance.

WARNING:

A short power-supply cord is provided to reduce the risks resulting from becoming entangled in or tripping over a longer cord.

If a long cord set or extension cord is used:

- The marked electrical rating of the cord set or extension cord should be at least as great as the electrical rating of the appliance.
- The long cord should be arranged so that it will not drape over the counter top or tabletop where it can be pulled on by children or tripped over unintentionally.

UTENSILS IN THE MICROWAVE

MATERIALS TO BE AVOIDED IN THE MICROWAVE OVEN

Utensils	Remarks
Aluminum tray	May cause arcing. Transfer food into microwave-safe dish.
Food carton with metal handle	May cause arcing. Transfer food into microwave-safe dish.
Metal or metal trimmed utensils	Metal shields the food from microwave energy. Metal trim may cause arcing.
Metal twist ties	May cause arcing and could cause a fire in the oven.
Paper bags	May cause a fire in the oven.
Plastic foam	Plastic foam may melt or contaminate the liquid inside when exposed to high temperature.
Wood	Wood will dry out when used in the microwave oven and may split or crack.

Utensil Test

1. Fill a microwave-safe container with 1 cup of cold water (250ml) along with the utensil in question.
2. Cook on maximum power for 1 minute.
3. Carefully feel the utensil. If the empty utensil is warm, do not use it for microwave cooking.
4. **Do not exceed 1 minute cooking time.**

MATERIALS YOU CAN USE IN THE MICROWAVE OVEN

Utensils	Remarks
Aluminium foil	Shielding only. Small smooth pieces can be used to cover thin parts of meat or poultry to prevent overcooking. Arcing can occur if foil is too close to oven walls. The foil should be at least 1 inch (2.5cm) away from oven walls.
Browning dish	Follow manufacturer's instructions. The bottom of browning dish must be at least 3/16 inch (5mm) above the turntable. Incorrect usage may cause the turntable to break.
Dinnerware	Microwave-safe only. Follow manufacturer's instructions. Do not use cracked or chipped dishes.
Glass jars	Always remove lid. Use only to heat food until just warm. Most glass jars are not heat resistant and may break.
Glassware	Heat-resistant oven glassware only. Make sure there is no metallic trim. Do not use cracked or chipped dishes.
Oven cooking bags	Follow manufacturer's instructions. Do not close with metal tie. Make slits to allow steam to escape.
Paper plates and cups	Use for short-term cooking/warming only. Do not leave oven unattended while cooking.
Paper towels	Use to cover food for reheating and absorbing fat. Use with supervision for a short-term cooking only.
Parchment paper	Use as a cover to prevent splattering or a wrap for steaming.
Plastic	Microwave-safe only. Follow the manufacturer's instructions. Should be labeled "Microwave Safe". Some plastic containers soften, as the food inside gets hot. "Boiling bags" and tightly closed plastic bags should be slit, pierced or vented as directed by package.
Plastic wrap	Microwave-safe only. Use to cover food during cooking to retain moisture. Do not allow plastic wrap to touch food.
Thermometers	Microwave-safe only (meat and candy thermometers).
Wax paper	Use as a cover to prevent splattering and retain moisture.

PRODUCT DETAILS

Model:	OM30X
Rated Voltage:	230V~50Hz
Rated Input Power(Microwave):	1450W
Rated Output Power(Microwave):	900W
Oven Capacity:	30L
Turntable Diameter:	315 mm
External Dimensions:	520x430x330mm
Net Weight:	Approx. 15.6kg

SETTING UP YOUR OVEN

Names of Oven Parts and Accessories

Remove the oven and all materials from the carton and oven cavity. Your oven comes with the following accessories:

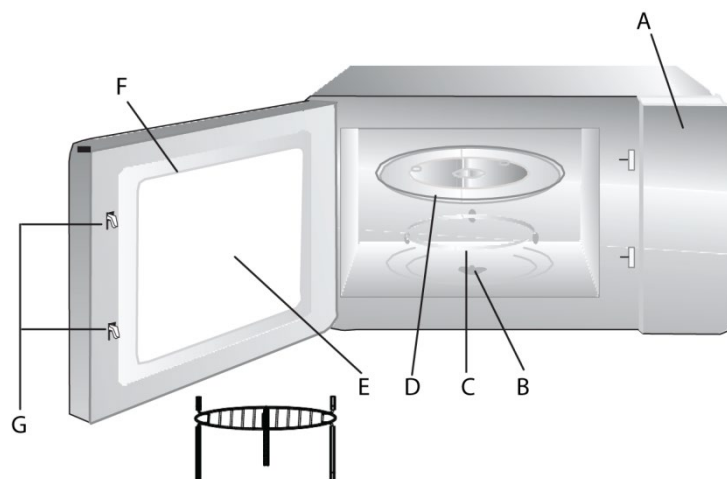

Grill rack (Only used in convection/grill cooking and can be placed on the glass tray).

- A) Control Panel
- B) Turntable Shaft
- C) Turntable Ring Assembly
- D) Glass Tray
- E) Observation Window
- F) Door Assembly
- G) Safety Interlock System

Turntable Installation

1. Never place the glass tray upside down. The glass tray should never be restricted.
2. Both glass tray and turntable ring assembly must always be used during cooking.
3. All food and containers of food are always placed on the glass tray for cooking.
4. If glass tray or turntable ring assembly cracks or breaks, contact your nearest authorized service center.

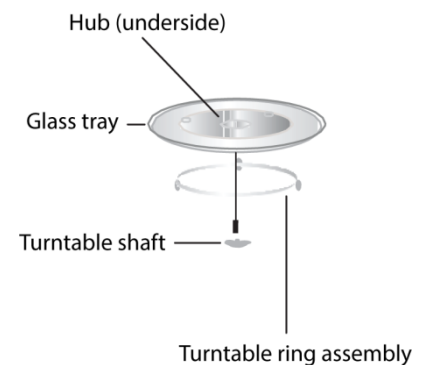

INSTALLATION

Countertop Installation

Remove all packing material and accessories. Examine the oven for any damage such as dents or broken door. Do not install if oven is damaged.

Cabinet: Remove any protective film found on the microwave oven cabinet surface.

Do not remove the light brown Mica cover that is attached to the oven cavity to protect the magnetron.

Installation

Select a level surface that provides enough open space for the intake and/or outlet vents.

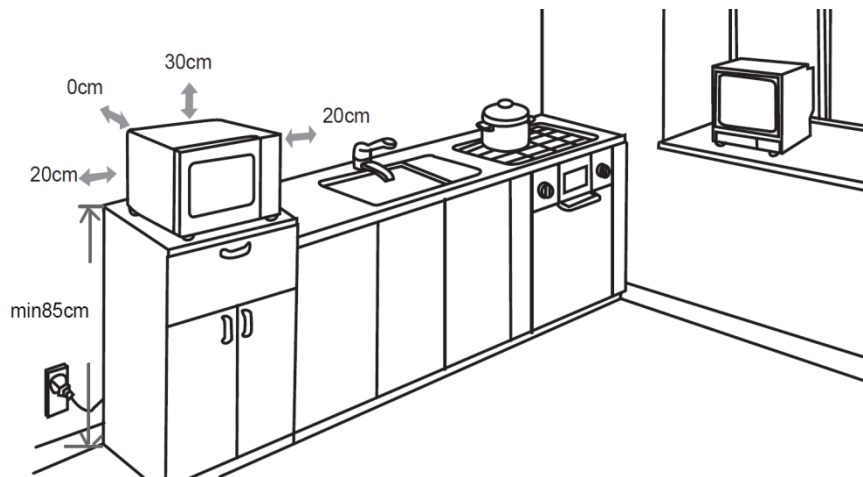

1. The minimum installation height is 85cm.
2. The rear surface of appliance shall be placed against a wall.
3. Leave a minimum clearance of 30cm above the oven, a minimum clearance of 20cm is required between the oven and any adjacent walls.
4. Do not remove the legs from the bottom of the oven.
5. Blocking the intake and/or outlet openings can damage the oven.
6. Place the oven as far away from radios and TVs as possible. Operation of microwave oven may cause interference to your radio or TV reception.
7. Plug your oven into a standard household outlet. Be sure the voltage and the frequency is the same as the voltage and the frequency on the rating label.

WARNING: Do not install oven over a range cooktop or other heat-producing appliance. If installed near or over a heat source, the oven could be damaged and the warranty would be void.

Built-In Installation

Built in installation is only suitable in a tower, with the unit positioned at a minimum of 850mm above the ground. Ventilation requirements can be seen in the figure and aligns with the trim kit suitable for this product, OTK30MX.



The accessible surface may be hot during operation.

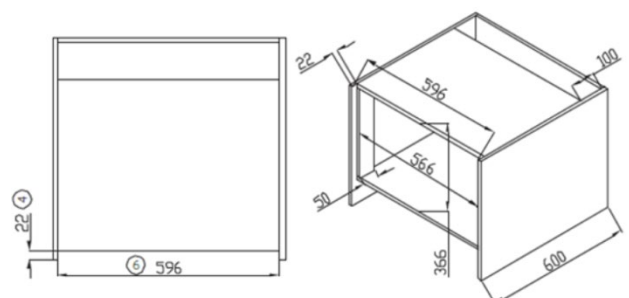
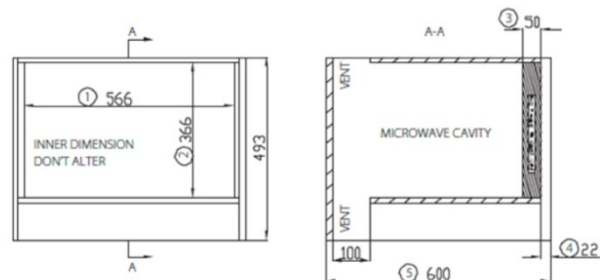



OPERATING INSTRUCTIONS

This microwave oven uses modern electronic controls to meet your cooking needs.

Setting the Clock

When the microwave oven is powered on, the oven will display "0:00" and the buzzer will ring once.

1. Press **"CLOCK/KITCHEN TIMER"** once - "00:00" displays.
2. Turn  to adjust the hour figures. The input time should be within 0-23(24-hour).
3. Press **"CLOCK/KITCHEN TIMER "**. The minute figures will flash.
4. Turn  to adjust the minute figures. The input time should be within 0-59.
5. Press **"CLOCK/KITCHEN TIMER "** to finish clock setting. ":" will flash.



Note:

- If the clock is not set, it would not function when powered.
- Whilst setting the clock, if you press **"STOP/CLEAR"** the oven will go back to the previous status automatically.

Kitchen Timer



1. Press **"CLOCK/KITCHEN TIMER "** once. The LED display will show "00:00".
2. Turn  to enter the correct timer. (The maximum cooking time is 95 minutes).
3. Press **"START/+30SEC./CONFIRM"** to confirm setting.
4. When the timer has elapsed, the buzzer will ring five times. If the clock has been set, the LED display will show the current time.

Microwave Cooking

1. Press **"MICROWAVE"**. The LED display will show **"P100"**. Press **"MICROWAVE"** for times, or turn  to choose the power you want. **"P100"**, **"P80"**, **"P50"**, **"P30"** or **"P10"** will display for each added press.
2. Press **"START/+30SEC./CONFIRM"** to confirm.
3. Turn  to set cooking time from 0:05 to 95:00.
4. Press **"START/+30SEC/CONFIRM"** again to start cooking.

Microwave Cooking Example

If you want to use 80% microwave power to cook for 20 minutes, you can operate the oven per the following steps:

- 1) Press **"MICROWAVE"** once. The screen will display **"P100"**.
- 2) Press **"MICROWAVE"** once again or turn  to choose 80% microwave power.
- 3) Press **"Start/+30Sec/Confirm"** to confirm. The screen will display **"P80"**.
- 4) Turn  to adjust the cooking time until the oven displays "20:00".
- 5) Press **"Start/+30Sec/Confirm"** to start cooking.

Note: the step quantities for the adjustment time of the coding switch are as follows:

0-1	min	: 5 seconds
1-5	min	: 10 seconds
5-10	min	: 30 seconds
10-30	min	: 1 minute
30-95	min	: 5 minutes

OPERATING INSTRUCTIONS

Microwave Power Chart



Press	Once	Twice	Thrice	4 Times	5 Times
Microwave Power	100%	80%	50%	30%	10%

Multi-Stage Cooking

A maximum of two stages can be set. If one stage is defrosting, it should be put the first stage. The buzzer will ring once after each stage and the next stage will begin.

Note: Auto menu and preheating cannot be set as one of the stages.

Example: If you want to defrost the food for 5 minutes, then to cook with 80% microwave power for 7 minutes, the steps are as follows:



1. Press **"Time Defrost"**. The screen will display **"dEF2"**.
2. Turn  to adjust the defrost time to 5 minutes.
3. Press **"MICROWAVE"** once.
4. Turn  to choose 80% microwave power. ("**P80**" will be displayed).
5. Press **"START/+30SEC./CONFIRM"** to confirm.
6. Turn  to adjust the cooking time to 7 minutes.
7. Press **"START/+30SEC./CONFIRM"** to start cooking.

Quick Cooking

1. Whilst the microwave oven is in standby, press **"START/+30SEC./CONFIRM"** key to cook with 100% power level for 30 seconds. Each press on the same key will increase the cooking time by 30 seconds. The maximum cooking time is 95 minutes.
2. During microwave, grill and combination states, press **"START/+30SEC./CONFIRM"** key to cook with 100% power level for 30 seconds. Each press on the same key will increase the time by 30 seconds.

Note: this function will not work during defrost and auto menu cooking.

Grill / Combi Cooking

1. Press **"Grill/Combi"** the LED display will show **"G-1"**. Press **"Grill/Combi"** for times, or turn  to choose the power you want. **"G"**, **"C-1"**, **"C-2"**, **"C-3"** or **"C-4"** will display for each added press.
2. Press **"Start/+30Sec/Confirm"** to confirm. Turn  to set cooking time from 0:05 to 95:00.
3. Press **"Start/+30Sec/Confirm"** to start cooking.

Example: If you want to use grill power to cook for 10 minutes, you can operate the oven per the following steps:

1. Press **"Grill/Combi"** once. The screen will display **"G-1"**.
2. Press **"Start/+30Sec/Confirm"** to confirm.
3. Turn  to adjust the cooking time until the oven displays **"10:00"**.
4. Press **"Start/+30Sec/Confirm"** to start cooking.

Note: When half the grill time has elapsed, the oven buzzer sounds twice. This is normal.

In order to have a better effect of grilling food, you should turn the food over. When you close the door the oven will continue cooking.



OPERATING INSTRUCTIONS

Combination Instructions

Instructions	Display	Microwave	Grill	Convection
1	C-1	●		●
2	C-2	●	●	
3	C-3		●	●
4	C-4	●	●	●

Convection Cooking (With Pre-Heating Function)

The convection cooking can let you to cook the food as a traditional oven. Microwave is not used. It is recommended that you should preheat the oven to the appropriate temperature before placing the food in the oven.

1. Press the "**CONVECTION**" key once. "140" will flash.
2. Keep pressing "**CONVECTION**" or turn  to select the convection heat.
Note: The temperature can be chosen from 140°C to 230°C degrees.
3. Press "**START/+30SEC/CONFIRM**" to confirm the temperature.
4. Press "**START/+30SEC/CONFIRM**" to start preheating. When the preheating temperature is reach, the buzzer will sound twice to remind you to put the food into the oven. The preheated temperature is displayed and will flash.
5. Put the food into the oven and close the door.
6. Turn  to adjust the cooking time. (The maximum time setting is 95 minutes.)
7. Press "**START/+30SEC/CONFIRM**" to start cooking.

Note: A cooking time cannot be input until the preheating temperature is reached. When the temperature is reached, the door must be opened to input the cooking time.

If the time not input in 5 minutes, the oven will stop preheating. The buzzer sounds five times and the oven goes back into standby mode.



Weight Defrost

1. Press "**Weight Defrost**". The LED display will show "**dEF1**".
2. Turn  to select the weight of food. At the same time, "**g**" will show on the LED display. The weight should be 100-2000g.
3. Press "**START/+30SEC./CONFIRM**" key to start defrosting.

Time Defrost

1. Press "**Time Defrost**". The oven will display "**dEF2**".
2. Turn  to select the cooking time. The maximum cooking time is 95 minutes.
3. Press "**START/+30SEC./CONFIRM**" key to start defrosting.

Auto Menu

1. In standby mode, turn  right to choose the function wanted, and "A-1", "A-2", "A-3"... "A-10" will be displayed.
2. Press "**START/+30 SEC/CONFIRM**" to confirm the menu you need.
3. Turn  to choose the weight of menu, and "g" indicator will be displayed.
Press "**START/+30 SEC/CONFIRM**" to start cooking.

OPERATING INSTRUCTIONS

Auto Menu Chart

Menu	Weight (g)	Display	Power
A1 Pizza	200	200	C-4
	300	300	
	400	400	
A2 Potato	1 (about 230g)	1	100%
	2 (about 460g)	2	
	3 (about 690g)	3	
A3 Meat	150	150	100%
	300	300	
	450	450	
	600	600	
A4 Fish	150	150	80%
	250	250	
	350	350	
	450	450	
	650	650	
A5 Vegetable	150	150	100%
	350	350	
	500	500	
A6 Beverage /Coffee	1 (about 240g)	1	100%
	2 (about 480g)	2	
	3 (about 720g)	3	
A7 Pasta	50 (with water 450ml)	50	80%
	100 (with water 800ml)	100	
	150 (with water 1200ml)	150	
A8 Popcorn	50	50	100%
	100	100	
A9 Cake	475	475	Preheat at 160 degrees
A10 Chicken	500	500	C-4
	750	750	
	1000	1000	
	1200	1200	

Inquiring Function

1. During cooking, press "**CLOCK/KITCHEN TIMER**" to check the current time. It will be displayed for 2-3 seconds.
2. During cooking, press "**MICROWAVE**". The current power will be displayed for 2-3 seconds.

Lock-Out Function for Children

Lock: In standby mode, hold "**STOP/CLEAR**" for 3 seconds. There will be a long beep which denotes the fact that the oven has entered into the child-lock state. The locked indicator will display if the time has been set.

Unlock: In locked mode, hold "**STOP/CLEAR**" for 3 seconds. There will be a long beep which denotes the fact that the lock is released.

MAINTENANCE AND CLEANING

CAUTION

Personal Injury Hazard

It is hazardous for anyone other than a competent person to carry out any service or repair operation that involves the removal of a cover which gives protection against exposure to microwave energy.

CLEANING

CAUTION: Be sure to unplug the appliance from the power supply.

1. Clean the cavity of the oven after use with a damp cloth.
2. Clean accessories in the usual way in soapy water.
3. The door frame and seal and neighbouring parts must be cleaned carefully with a damp cloth when they are dirty.
4. Do not use harsh abrasive cleaners or sharp metal scrapers to clean the oven door glass since they can scratch the surface, which may result in shattering of the glass.

Cleaning Tip - For easier cleaning of the cavity walls that the cooked food can touch:

- Place half a lemon in a bowl. Add 300ml water and heat on 100% microwave power for 10 minutes.
- Wipe the oven clean using a soft, dry cloth.

TROUBLESHOOTING

Normal Operation	
Microwave oven interfering with TV reception	Radio and TV reception may be interfered with when the microwave oven is operating. It is similar to the interference of small electrical appliances, such as electric mixers, vacuum cleaners and electric fans. This is normal.
Dim oven light	In low power microwave cooking, the oven light may become dim. This is normal.
Steam accumulating on door, hot air out of vents	Whilst cooking, steam may come out of food. Most of this will dissipate through the vents. Some may accumulate on a cool place like the door. This is normal.
Oven started accidentally with no food in	It is forbidden to run the unit without any food inside. This is very dangerous.

Problem	Possible Cause	Remedy
Oven cannot be started	Power cord not plugged in properly.	Unplug. Plug back in again after 10 seconds.
	Fuse blown or circuit breaker tripped.	Replace fuse or reset circuit breaker.
	Trouble with outlet.	Test outlet with other appliances.
Oven does not heat	Door not closed properly.	Ensure that the door is properly closed.
Glass turntable makes noise when microwave oven operates	Dirty roller rest and oven bottom.	Refer to Maintenance and Cleaning" to clean dirty parts.



AUSTRALIAN AND NEW ZEALAND PRODUCT WARRANTY STATEMENT OF STANDARD WARRANTY CONDITIONS

AUSTRALIAN CUSTOMERS

Our goods come with guarantees that cannot be excluded under the Australian Consumer Law. You are entitled to a replacement or refund for a major failure and for compensation for any other reasonably foreseeable loss or damage. You are also entitled to have the goods repaired or replaced if the goods fail to be of acceptable quality and the failure does not amount to a major failure.

NEW ZEALAND CUSTOMERS

Nothing herein contained shall be construed in any way as excluding or limiting your rights under the Consumer Guarantee Act 1993.

OUR WARRANTY

This product is also covered by the manufacturer's warranty set out in this document (Our Warranty).

Our Warranty is for a period of twenty four (24) months from the date of purchase. This is in addition to (and does not exclude, restrict or modify) any rights or remedies to which you may already be entitled to under the Australian consumer law or the New Zealand Consumer Guarantee act 1993 relating to this product. Our warranty (which is subject to the conditions below) covers rectification free of charge of any fault arising from defective materials or components or faulty workmanship. The product will be repaired or replaced at the option of Omega.

Our warranty is subject to the following conditions:

1. That the purchaser contact Omega prior to any product repair.
2. That the purchaser carefully follows all instructions provided with the product and complies with all relevant electrical & plumbing regulations in their State when installing the product.
3. That the purchaser carefully follows the instructions provided in the owner's handbook relating to the proper use and care of the product and does not use the product for any purpose other than the DOMESTIC use for which it has been designed. If the appliance is used in commercial applications or for rental purposes, Our Warranty is limited to a warranty of Twelve (12) months covering all parts with Three (3) months on any labour cost of service or repair.

WHAT IS COVERED: By Our Warranty

During the warranty period, Omega or its authorised Service Centre will, at no extra charge, if your appliance is readily accessible without the need of special equipment and subject to the terms and conditions of this warranty, repair or replace any parts which it considers defective.

WHAT IS NOT COVERED: By Our Warranty

1. Products installed damaged or incomplete or not in compliance with the relevant electrical & plumbing regulations in their State.
2. Normal wear and tear e.g. cleaning, light globes, filters etc.
3. Failure resulting from power surges and electrical storms.
4. Insect or vermin infestation.
5. Unauthorised repairs or use of non- genuine Omega parts.
6. Any failure caused by the product not being used in accordance with the instruction and the installation manual provided with the product.
7. Misuse or abuse, including failure to properly maintain or service.
8. The clearing of blockages in pumps and hoses.
9. Damage which occurs during delivery or installation.
10. Claims to product surface coating due to liquid or solid spill-overs, accidental damage or damage caused from cleaning products not recommended by Omega.

HOW TO CLAIM YOUR WARRANTY

Please refer to our website address below for Omega in Australia or New Zealand to register your warranty online.

If you are contacting Omega regarding any warranty claims and spare parts inquiries, please make sure you have the following information on hand:

1. Product Name/Model Number
2. Serial Number/s
3. Purchase Date (as per invoice or proof of purchase)
4. Purchased From
5. Warranty Registration Number

IN AUSTRALIA

www.omegaplumbing.com.au/customer/warranty

Omega is division of Shriro Australia PTY LTD

ABN 28 002 386 129

Customer care: 1300 739 033

Email: customercare@shriro.com.au

IN NEW ZEALAND

www.omegaplumbing.co.nz/customer

Omega is division of Monaco Corporation Limited
(Member of Shriro Australia PTY LTD)

Phone: (09) 415 6000

Email: customercare@monacocorp.co.nz