





Operating and installation Instructions Washing machine



To avoid the risk of accidents or damage to the appliance, it is **essential** to read these instructions before it is installed and used for the first time.

Contents

| | |
|--|----|
| Caring for the environment | 6 |
| Warning and Safety instructions | 7 |
| Operating the washing machine | 15 |
| Control panel | 15 |
| Symbols on the control panel | 16 |
| Symbols in the display | 17 |
| Sensor controls and touch display with sensor controls | 18 |
| Main menu | 18 |
| Examples on how to operate the appliance | 19 |
| Using for the first time | 20 |
| 1. Preparing the laundry | 25 |
| 2. Loading the washing machine | 26 |
| 3. Selecting a programme | 27 |
| 4. Selecting programme settings | 28 |
| 5. Adding detergent | 30 |
| Adding fabric softener or liquid starch separately | 31 |
| 6. Starting the programme - the end of the programme | 32 |
| Delay start | 33 |
| Programme chart | 34 |
| Mop programmes | 34 |
| Programme packages | 36 |
| Standard programmes | 42 |
| Extras | 43 |
| Pre-wash  | 43 |
| Pre-rinse  | 43 |
| Rinse plus  | 43 |
| Microfibre  | 43 |
| Special features in the programme sequence | 44 |
| Spinning | 44 |
| Anti-crease | 44 |
| Changing the programme sequence | 45 |
| Changing a programme | 45 |
| Cancelling a programme | 45 |

| | |
|--|----|
| Switching on the washing machine after an interruption to the power supply ... | 45 |
| Adding or removing laundry | 46 |
| Cleaning and care | 47 |
| Cleaning the external casing and fascia panel | 47 |
| Cleaning the detergent dispenser drawer | 47 |
| Cleaning the drum, suds container and drainage system | 49 |
| Cleaning the sealing ring | 49 |
| Cleaning the filters in the water inlet | 50 |
| Problem solving guide | 51 |
| The programme does not start | 51 |
| Programme cancellations and fault messages | 52 |
| A fault message appears in the display | 53 |
| An unsatisfactory wash result | 54 |
| General problems with the washing machine | 55 |
| The door will not open | 56 |
| Opening the door in the event of a blocked drain outlet and/or power cut | 57 |
| After sales service | 59 |
| Contact in case of fault | 59 |
| Optional accessories | 59 |
| Installation | 60 |
| Front view | 60 |
| Rear view | 61 |
| Installation locations | 62 |
| Installation notes | 62 |
| Transporting the washing machine to its installation site | 63 |
| Installation surface | 64 |
| Removing the transit bars | 64 |
| Fitting the transit bars | 66 |
| Aligning the washing machine | 67 |
| Fixing bracket for plinth | 68 |
| Positioning the fixing bracket | 68 |
| Installing the fixing bracket | 69 |
| Securing the washing machine with the fixing bracket | 69 |
| External control equipment | 70 |
| Payment system | 70 |
| Water connection | 71 |
| Cold water connection | 71 |
| Hot water connection* | 72 |
| Drainage | 72 |
| Drain valve | 72 |

Contents

| | |
|--------------------------------------|-----------|
| Electrical connection | 73 |
| Technical data | 74 |
| Supervisor level | 76 |
| Code-based access | 76 |
| Changing the code | 76 |
| Opening the Supervisor level | 76 |
| Exiting the Supervisor level | 76 |
| Language | 77 |
| Brightness | 77 |
| Clock display | 77 |
| Finish tone volume | 77 |
| Keypad tone | 77 |
| Welcome tone volume | 77 |
| Fault alarm | 77 |
| Memory | 77 |
| Anti-crease | 78 |
| Suds cooling | 78 |
| "Display" switch-off status | 78 |
| "Machine" switch-off status | 79 |
| Delay start | 79 |
| Programme name | 79 |
| Visibility parameters | 79 |
| Pre-wash water | 79 |
| Main wash water | 80 |
| First rinse water | 80 |
| Final rinse water | 80 |
| Low water pressure | 80 |
| Pre-spin mops | 80 |
| Mops temp. Std plus | 81 |
| Mops Ch.-th. dis. | 81 |
| Mops Th.-disin. | 81 |
| Microfibre mops | 81 |
| Mops, pre-treat rpm | 81 |
| Cl. cloths temp. Standard plus | 81 |
| Clean. cloths Ch.-th. dis. | 82 |
| Pre-treat cl. cloths rpm | 82 |
| Empty sensor | 82 |
| Early warning counter | 82 |
| Water level Cottons | 82 |
| Water level Minimum iron | 82 |
| Pre-wash temp. Cottons | 83 |

| | |
|---|----|
| Wash time pre-wash..... | 83 |
| Wash time Cottons..... | 83 |
| Wash time Minimum iron..... | 83 |
| Pre-rinse Cottons | 83 |
| Pre-rinse Minimum iron | 83 |
| Pre-wash Cottons/Min. iron | 83 |
| Cottons rinses | 84 |
| Minimum iron rinses | 84 |
| Disinfection rinse | 84 |
| Programme packages | 84 |
| Disinfection prog. code | 85 |
| Temperature reduction | 85 |
| Automatic dispensing..... | 85 |
| Adjustment value dosage 1–6..... | 85 |
| COM module selection..... | 85 |
| Availability of Miele digital products..... | 86 |
| Wi-Fi/LAN | 86 |
| Network time | 87 |
| External programme lock | 87 |
| Peak load signal | 87 |
| Peak load prevention..... | 87 |
| Remote | 88 |
| RemoteUpdate | 88 |
| SmartGrid (only functional in selected countries)..... | 88 |
| Alternating current..... | 88 |
| Heater | 88 |
| Legal information..... | 89 |
| Copyright and licences for operating and control software | 89 |
| Payment system..... | 89 |
| Settings for payment systems..... | 89 |
| Feedback signal to pay system..... | 90 |
| Payment system lock | 90 |
| FOC programmes..... | 91 |
| Clear paid signal..... | 91 |
| Debounce time | 91 |

Caring for the environment

Disposal of the packing material

The transport and protective packaging has been selected from materials which are environmentally friendly for disposal, and can normally be recycled.

Recycling the packaging reduces the use of raw materials in the manufacturing process and also reduces the amount of waste in landfill sites. Ensure that any plastic wrappings, bags etc. are disposed of safely and kept out of the reach of babies and young children. Danger of suffocation.

Disposing of your old appliance

Electrical and electronic appliances often contain valuable materials. They also contain specific materials, compounds and components, which were essential for their correct function and safety. These could be hazardous to human health and to the environment if disposed of with your domestic waste or if handled incorrectly. Please do not, therefore, dispose of your old appliance with your household waste.



Please dispose of it at your local community waste collection / recycling centre for electrical and electronic appliances. You are also responsible for deleting any personal data that may be stored on the appliance prior to disposal. Please ensure that your old appliance poses no risk to children while being stored prior to disposal.

Warning and Safety instructions

This washing machine complies with all current local and national safety requirements. However, inappropriate use can lead to personal injury and damage to property.

Read the operating instructions carefully before using the washing machine. They contain important information on safety, installation, use and maintenance of the appliance. This prevents both personal injury and damage to the washing machine.

In accordance with standard IEC 60335-1, Miele expressly and strongly advises that you read and follow the instructions in “Installation”, as well as in the “Warning and Safety instructions”.

Miele cannot be held liable for injury or damage caused by non-compliance with these instructions.

Keep these operating instructions in a safe place and pass them on to any future owner.

When instructing other people how to use the washing machine, they must be made aware of these Warning and Safety instructions.

Correct application

- ▶ The washing machine is only suitable for washing fabrics with a care label stating that they are suitable for machine washing. Any other applications may be dangerous. The manufacturer cannot be held liable for damage resulting from incorrect or improper use or operation of the machine.
- ▶ This washing machine must be used as described in the operating instructions and must be checked on a regular basis to make sure it is functioning correctly. Maintenance must be carried out when necessary.
- ▶ The washing machine is not suitable for outdoor use.

Warning and Safety instructions

- ▶ This washing machine is intended for commercial use in small businesses, care homes, sports clubs, hospitals and other similar commercial environments. This machine may also be operated by lay persons in public areas such as laundrettes, communal laundry rooms or similar commercial environment.
- ▶ This washing machine is not intended for use by persons (including children) with reduced physical, sensory or mental capabilities, or lack of experience and knowledge, unless they have been given supervision or instruction concerning its use by a person responsible for their safety.
- ▶ Young children must not be allowed to use this appliance.
- ▶ Older children may only use the appliance when its operation has been clearly explained to them and they are able to use it safely. They must be able to understand and recognise the possible dangers caused by incorrect operation.
- ▶ Cleaning or maintenance on the washing machine may only be carried out by older children under the supervision of an adult.
- ▶ Always supervise any children in the vicinity of the washing machine. Never allow children to play with the washing machine.
- ▶ Disinfection programmes must not be interrupted, as this can have a limiting effect on the disinfection result. It is the operator's responsibility to ensure that the standard of disinfection in thermal as well as chemo-thermal procedures is maintained by carrying out suitable validation tests.

Technical safety

▶ Before installing and operating the washing machine, check it for any visible exterior damage. Do not set up or use a damaged washing machine.

▶ The electrical safety of this washing machine can only be guaranteed when continuity is complete between it and an effective earthing system which complies with current local and national safety regulations.

It is most important that this basic safety requirement is present and regularly tested and, when there is any doubt, the on-site wiring system should be inspected by a qualified electrician.

Miele cannot be held liable for the consequences of an inadequate earthing system (e.g. electric shock).

▶ Unauthorised repairs could result in unforeseen dangers for the user, for which the manufacturer cannot accept liability. Repairs must only be carried out by a Miele authorised service technician, otherwise any subsequent damage will not be covered by the warranty.

▶ Do not make any alterations to the machine, unless authorised to do so by Miele.

▶ In the event of a fault or for cleaning purposes, the washing machine must be isolated from the electricity supply. It is only completely isolated if:

- it is switched off at the wall socket and the plug is withdrawn, or
- the mains fuse is disconnected, or
- it is switched off at the mains circuit breaker.

For further information see “Installation - Electrical connection”.

Warning and Safety instructions

- ▶ If the electrical connection cable is faulty, it must only be replaced by a Miele authorised service technician to protect the user from danger.
- ▶ The washing machine must be connected to the water supply using the new hose set supplied with the appliance. Old hose sets should not be re-used. Check the hose regularly for signs of wear. Replace it in good time to avoid the risk of leaks and water damage.
- ▶ Faulty components must only be replaced by genuine Miele original spare parts. Miele can only guarantee the safety standards of the machine when Miele replacement parts are used.
- ▶ Do not connect the machine to the mains electricity supply by a multi-socket adapter, extension lead or similar. These do not guarantee the required safety of the machine (fire hazard due to the risk of overheating).
- ▶ The machine must not be installed and operated in mobile locations (e.g. on a ship).
- ▶ Please observe the instructions in “Installation” and “Technical data”.
- ▶ If the washing machine is equipped with a mains plug, it must be easily accessible after installation so that the machine can be disconnected from the electricity supply if necessary.

Warning and Safety instructions

▶ If the appliance is hard wired, an on-site dual circuit breaker must be accessible at all times in order to disconnect the washing machine from the mains supply. The means of disconnection must be incorporated in the fixed wiring in accordance with the wiring rules.

▶ Temporary or permanent operation with a self-sufficient or non-mains synchronous energy supply system (e.g. isolated networks, back-up systems) is possible. A requirement for the operation is that the energy supply system complies with all current local and national requirements that apply to stand-alone, solar and/or battery systems.

The protective measures provided in the building installation and in this Miele product must also be assured in their function and operation in isolated operation or in non-mains synchronous operation, or replaced with equivalent measures in the installation. For example, as described in the current publication of VDE-AR-E 2510-2.

Correct use

▶ The maximum load is 8.0 kg (dry laundry). See the “Programme chart” for the maximum recommended loads for individual programmes.

▶ Do not install your washing machine in a room where there is a risk of frost. Frozen hoses may burst or split, and the reliability of the electronic control unit may be impaired at temperatures below freezing point.

▶ Before using the machine for the first time, check that the transit bars at the rear of the washing machine have been removed (see “Installation and connection – Removing the transit bars”). During spinning, transit bars which are still in place can cause damage to both the machine and adjacent furniture or appliances.

Warning and Safety instructions

- ▶ Turn off the tap if the machine is to be left for any length of time (e.g. while on holiday), especially if there is no floor drain (gully) in the immediate vicinity.
- ▶ If the ventilation openings are in the base of the washing machine, ensure that they are not obstructed by deep-pile carpet or similar.
- ▶ Make sure that no foreign objects (e.g. nails, pins, coins, paper clips) find their way into the machine with the laundry. In particular, shake out any metal shavings which could be in the cleaning cloths before washing. These can damage components of the machine (e.g. suds container, drum). Damaged components can, in turn, result in damage to the laundry.
- ▶ If the correct amount of detergent is dispensed, the machine should not need to be descaled. If, however, you do wish to descale it, only use special non-corrosive descaling agents and strictly observe the instructions on the packaging. Special descaling agent is available from your Miele dealer or from Miele. Strictly observe the instructions for the packaging.
- ▶ For textiles that have been treated with solvent-based cleaning agents, always check whether they can be washed in a washing machine. To check whether this is possible, refer to safety notes, information concerning the product's environmental compatibility, and other information.
- ▶ Never use solvent-based detergents, e.g. those containing benzene, in this washing machine. This may result in damage to component parts and create toxic fumes. Risk of fire and explosion!
- ▶ Gasoline, petroleum, kerosene, paraffin, or any easily flammable liquid must not be stored or used near the washing machine. Risk of fire and explosion!

Warning and Safety instructions

- ▶ Only use dyes suitable for use in a washing machine. Always observe the manufacturer's instructions carefully.
- ▶ Dye removers contain sulphur compounds which can cause damage such as corrosion. Dye removers must not be used in the washing machine.
- ▶ Avoid contact between stainless steel surfaces (front, lid, casing) and liquid detergents or disinfecting agents which contain chlorine or sodium hypochlorite. These agents can cause corrosion on stainless steel. Aggressive vapours containing chlorine can also be corrosive. Do not store open containers of these agents near the machine.
- ▶ Do not use a high-pressure cleaner or water jet to clean the washing machine.
- ▶ It is particularly important to observe the manufacturer's instructions when using a combination of cleaning agents and special application products. Products must only be used for applications approved by the manufacturer to avoid any material damage or the occurrence of strong chemical reactions.
- ▶ If detergent has come into contact with the eyes, rinse out immediately with plenty of lukewarm water. If detergent has accidentally been ingested, seek medical advice immediately. People with damaged or sensitive skin should avoid contact with detergent.
- ▶ When adding or removing laundry during the main wash, your skin may come into contact with detergent, particularly if the detergent is dispensed externally. Take care when placing your hands inside the drum. If suds have come into contact with the skin, rinse off immediately with lukewarm water.

Warning and Safety instructions

Accessories



- ▶ Only use genuine Miele spare parts and accessories with this machine. Using spare parts or accessories from other manufacturers will invalidate the warranty, and Miele cannot accept liability.
- ▶ Miele tumble dryers and Miele washing machines can be installed as a washer-dryer stack. This requires a Miele washer-dryer stacking kit which can be purchased separately. Please ensure that the washer-dryer stacking kit is suitable for your Miele tumble dryer and your Miele washing machine.
- ▶ If installing the machine on a Miele plinth (available as an optional accessory), please make sure you order the correct one for this washing machine.

Miele cannot be held liable for damage caused by non-compliance with these Warning and Safety instructions.

Operating the washing machine

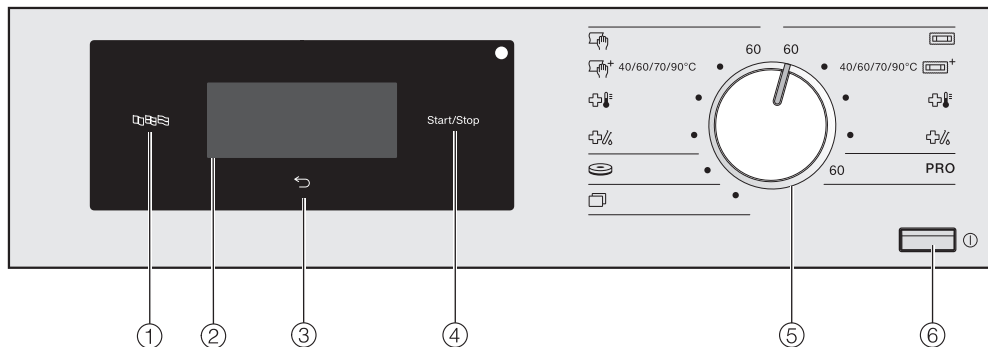
Control panel



- ① **Language  sensor control**
For selecting the current user language.
The operating language is displayed again at the end of the programme.
- ② **Touch display with sensor controls**
Displays the selected programme.
The programme settings are selected using the sensor controls in the touch display.
- ③ **Back  sensor control**
Takes you back one level in the menu.
- ④ **Start/Stop sensor control**
For starting the selected programme and cancelling a programme that has already started.
- ⑤ **Programme selector**
For selecting the wash programme.
The programme selector can be turned clockwise or anti-clockwise.
- ⑥ **Button **
For switching the washing machine on and off.
The washing machine switches itself off automatically to save energy. This occurs 15 minutes after the end of the programme/anti-crease phase, or after being switched on if no further selection is made.

Operating the washing machine

Symbols on the control panel

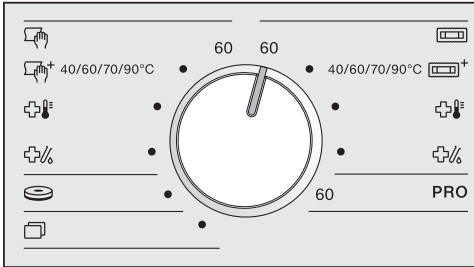

Right side:



Mops



Mops plus



Mops thermal disinfection



Mops chemo-thermal disinfection

PRO

Cottons PRO

Left side:



Cloths



Cloths plus



Cleaning cloths thermal disinfection



Cleaning cloths chemo-thermal disinfection



Pads



Further programmes

Symbols in the display



Temperature: Use the *Temperature* sensor control to set the temperature of the wash programme.



Spin speed: Use the *Spin speed* sensor control to set the spin speed of the wash programme.



Extras: Use the *Extras* sensor control to add Extras to a wash programme.



Pre-wash: Use the *Pre-wash* sensor control to select the *Pre-wash* Extra for a wash programme.



Pre-rinse: Use the *Pre-rinse* sensor control to rinse the laundry before the start of the wash programme.



Rinse plus: Use the *Rinse plus* sensor control to add an additional rinse cycle to a wash programme.



Microfibre: Use the *Microfibre* sensor control to gently cool microfibre mops at the end of the main wash cycle.



Residual moisture: Use the *Residual moisture* sensor control to set the residual moisture after spinning.



Spin duration: Use the *Spin duration* sensor control to set the residual moisture after spinning.



Further selections: Use the *Further selections* sensor control to select further options.



Supervisor level: Use the *Supervisor level* sensor control to alter the washing machine's settings.



Delay start: Use the *Delay start* sensor control to set the start time of a wash programme ...





... or the finish time



... or the time until the programme starts.

Operating the washing machine

Sensor controls and touch display with sensor controls

The ,  and *Start/Stop* sensors and the sensor controls in the display react to finger contact. Every touch of a sensor is confirmed by an audible tone. You can adjust the volume of the keypad tone or switch it off (see “Supervisor level”).

The control panel with the sensor controls and the touch display can be scratched by pointed or sharp objects, e.g. pens.



Only touch the display with your fingers.

Main menu

The main menu of a wash programme displays different values depending on the programme.





For programmes with a fixed temperature setting:



- the selected programme with the set temperature
- the programme duration
- the spin speed set 
- the selectable Extras 
- Further selections : Delay start and the settings in the Supervisor level

For programmes with a variable temperature setting:



- the selected programme
- the programme duration
- the temperature set 
- the spin speed set 
- the selectable Extras 
- Further selections : Delay start and the settings in the Supervisor level

Operating the washing machine

Examples on how to operate the appliance

Selection lists

The \wedge and \vee arrows on the right of the display indicate that further choices are available.

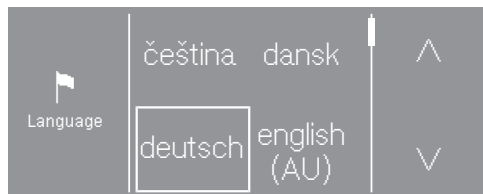

The list scrolls down when the \vee sensor control is touched. The list scrolls up when the \wedge sensor control is touched.

The scroll bar indicates that further options follow.

The currently selected value is marked with a frame.

Touch the required value to select it.

Single selection

If there are no arrows, the selection is limited to the displayed values.

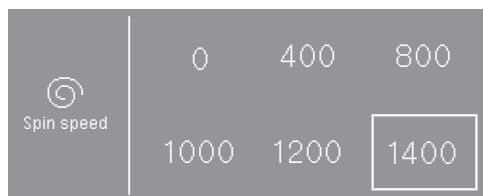

The currently selected value is marked with a frame.

Touch the required value to select it.

Setting numerical values

To change a numerical value, use the \wedge and \vee arrows above or below the numbers you want to change.



Touch the \wedge and \vee arrows and confirm with the *OK* sensor.

Exiting a submenu

Select the back \leftarrow sensor to exit a submenu.

If a value is selected in a submenu but not confirmed with *OK*, this value is discarded by selecting the \leftarrow sensor control.

Using for the first time

 Damage resulting from incorrect installation and connection.

Installing and connecting the washing machine incorrectly will cause serious damage to property.

Please observe the instructions in “Installation and connection”.

Emptying the drum

A swivel elbow for the drain hose and/or assembly material may be stored in the drum.

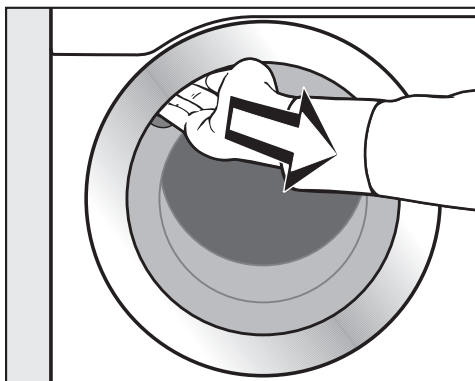

- Pull open the door.
- Remove the swivel elbow and assembly material.
- Shut the door with a gentle swing.

Switching on the washing machine

- Press the  button.

The welcome screen will light up.

When commissioning the washing machine for the first time, you will have to define the settings for the daily use of the appliance. Some settings can only be configured during the initial commissioning process. After that, they must be changed by Miele.



Complete the initial commissioning process.

These settings are also described in “Supervisor level”.

Setting the display language

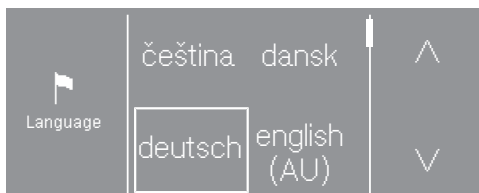
You will be asked to select the language for the display. You can change the language at any time (see “Supervisor level - Language”).



- Touch the  or  sensor until the language you want appears in the display.
- Touch the sensor for the required language.

The selected language is marked with a frame and the display will change to the next setting.

Setting the display brightness

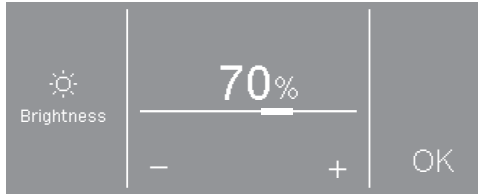

- Set the desired brightness with the – and + sensors and confirm your selection with the OK sensor.

The display will change to the next setting.

Reference to external appliances

A reference to external hardware appears.

- Confirm with the OK sensor.

Before initial commissioning, connect the XCI box or adapter or slide a communication module into the slot on the back of the machine. The washing machine must be disconnected from the mains for this purpose. Then start the commissioning process.

Confirming the time query



- Touch the Yes or No sensor.

If you select Yes, the system will skip the Clock display setting.

If you select No, the display will switch to the Clock display setting.

Setting the time of day

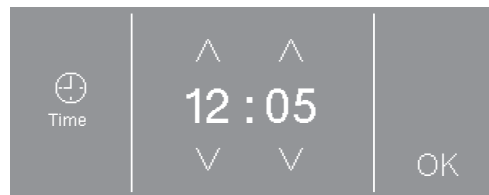

- Use the ∨ and ∧ sensor controls to enter the time and confirm your entry with the OK sensor.

The display will change to the next setting.

Using for the first time

Selecting programme packages

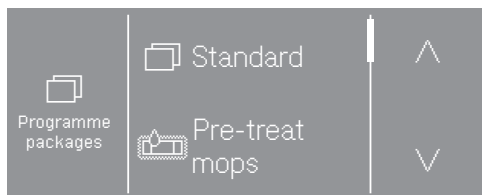

- Touch the \wedge or \vee sensor control until the programme package you want appears in the display.
- Touch the sensor control of the programme package.

The display shows the associated programmes.

The activated programmes are marked with a frame.

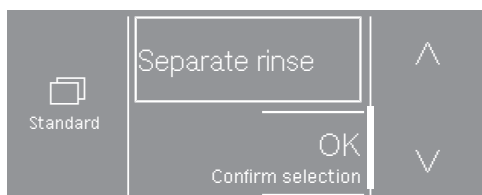

- Touch the sensors for the programmes.

The programmes are activated (framed) or deactivated (no frame).

- Confirm with the OK sensor.

The display switches back to the programme packages.

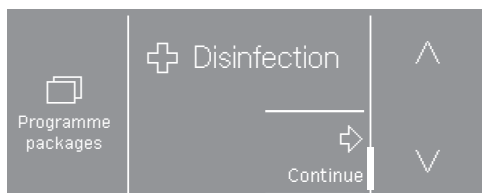

- Select other programme packages or confirm your selection with the Next sensor control.

The display will change to the Pre-wash water setting.

Switching on automatic dispensing

Automatic dispensing can be activated via the XCI box or the COM module.

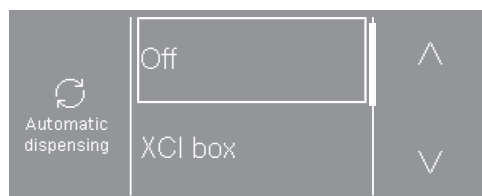

- Touch the \wedge or \vee sensor until the option you want appears in the display.
- Touch the sensor for the option.
- If you do not want to switch on automatic dispensing, touch the Off sensor.

The display will change to the next setting.

Setting up a payment system

If you wish to set up a payment system, read the chapter “Supervisor level - Payment system”.

If you do not wish to set up a payment system, you can skip this step.

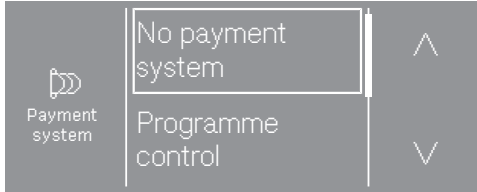

- Touch the No payment system sensor.

The display will change to the next setting.

Selecting pre-wash water

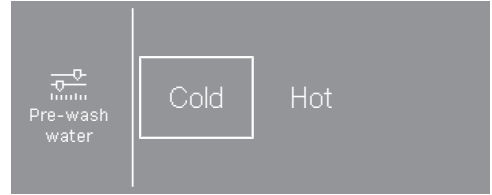

- Touch the Cold sensor if the washing machine is only connected to the cold water supply, or touch Hot if the washing machine is connected to both cold and hot water.

The display will change to the next setting.

Selecting main wash water

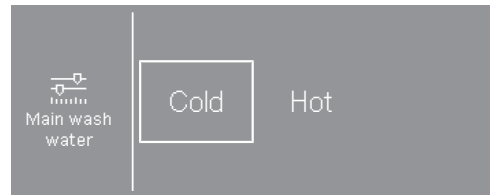

- Touch the Cold sensor if the washing machine is only connected to the cold water supply, or touch Hot if the washing machine is connected to both cold and hot water.

Further information will appear in the display.

Using for the first time

Removing the transit bars

The display will remind you to remove the transit bars.

 Damage resulting from failure to remove the transit bars.

Failure to remove the transit bars can result in damage to the washing machine and to adjacent cabinetry or appliances.

Remove the transit bars as described in “Installation and connection”.

- Confirm that the transit bars have been removed with the *OK* sensor.

The following appears in the display:

Continue setting up as described in the Operating instructions

- Confirm the message with the *OK* sensor.

Completing the commissioning process

To complete commissioning, the *Cleaning cloths thermal disinfection* programme must be run without laundry and without detergent.

If the power is interrupted prior to the start of the first wash programme (e.g. if the machine is switched off with the  button), the initial commissioning process can be completed again. Once a wash programme has been running for over 20 minutes, the initial commissioning process does not need to be performed again.

- Turn on the water taps.
- Turn the programme selector to  *Cleaning cloths thermal disinfection*.

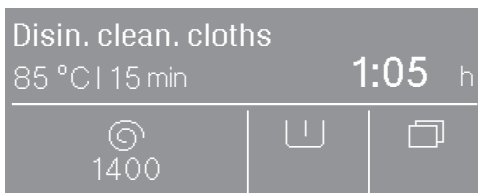



- Touch the *Start/Stop* sensor.

When the programme has finished, your machine is ready for use for the first time.

1. Preparing the laundry

 Damage due to foreign objects.
Foreign objects (e.g. nails, coins, paper clips etc.) can cause damage to garments and to components in the machine.
Check the mops or the laundry before washing and remove any foreign objects.

 Damage due to solvent-based cleaning agents.
Cleaning agents containing benzene, stain remover, etc., can damage plastic parts.
When pre-treating garments, make sure that any plastic parts (e.g. buttons) do not come into contact with cleaning agent.

 Risk of explosion due to solvent-based cleaning agents.
When using solvent-based detergents, an explosive mixture may develop.
Never use solvent-based cleaning agents in the washing machine.

Sorting the washing items

- Separate the mops, cleaning cloths and pads.
- Shake mops, cleaning cloths and pads out well to get rid of coarse soiling before placing them in the drum.

Sorting the laundry

- Empty all pockets.
- Clean badly soiled areas and stains on the textiles before washing. Spillages should be carefully dabbed off using a soft, colourfast cloth.
- Sort the laundry by colour and by care label. Most garments have a textile care label in the collar or side seam.

Useful tip: Do not wash items which are specified by the manufacturer as **not washable** on the care label ( symbol).

2. Loading the washing machine

Opening the door

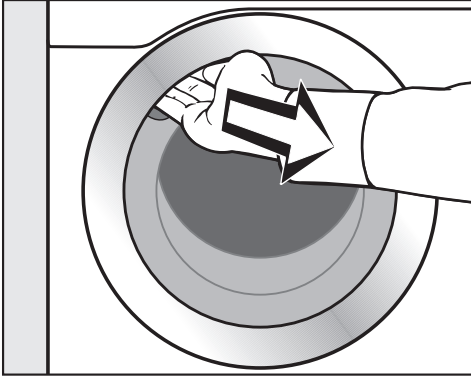

- Reach under the door grip and pull the door open.

Check the drum for pets or foreign objects before loading it with laundry.

- Load the mops, cleaning cloths or pads loosely in the drum.
- Unfold the laundry and load loosely into the drum.

Mixing both large and small items gives better wash results and helps distribute the load evenly during spinning.

The most efficient use of energy and water is achieved when a full load is washed. However, do not overload as this reduces cleaning efficiency and causes creasing.

Closing the door

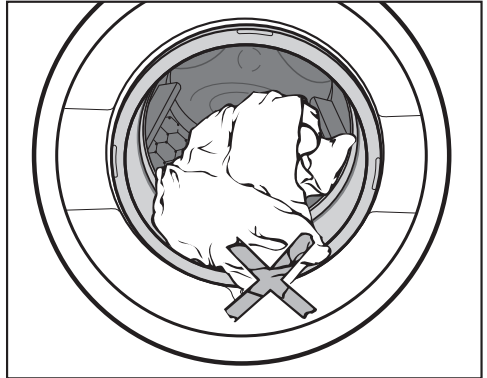

- Make sure that no items are caught between the door and the seal.

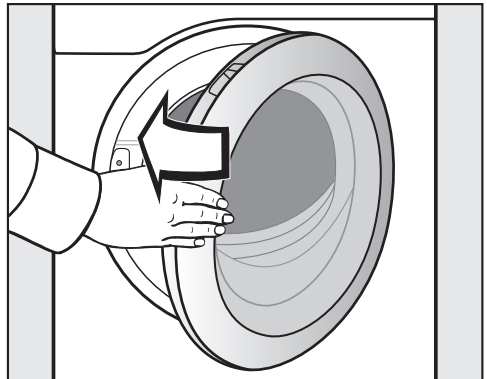

- Shut the door with a gentle swing.

3. Selecting a programme

Switching on the washing machine

- Press the  button.

Selecting a programme

Selecting standard programmes with the programme selector

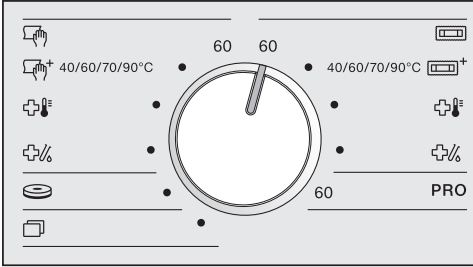

- Turn the programme selector to the required programme.

The selected programme will be shown in the display. The display will then change to the main menu for that programme.

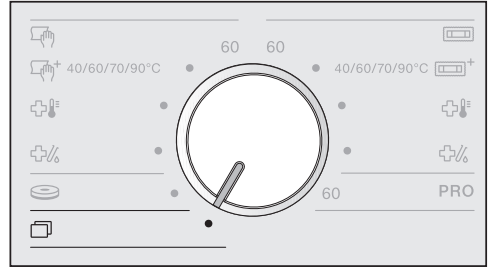

Selecting further programmes with the programme selector turned to

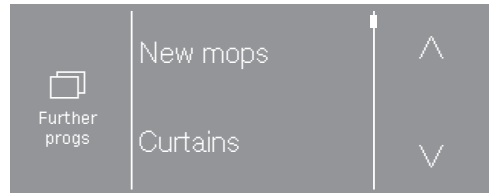

- Turn the programme selector to the  position.

You can select the required programme via the display.



- Touch the  or  sensor control until the programme you want appears in the display.
- Touch the sensor for that programme.

The display will change to the main menu for that programme.

4. Selecting programme settings

Selecting the temperature

You can alter the preset temperature of certain programmes.

- Touch the *Temperature* 🌡️ sensor.

The following will appear in the display:

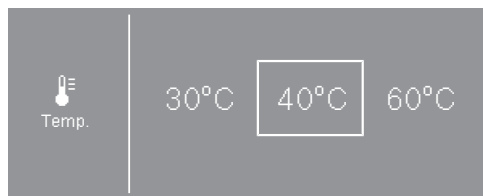

- Select the desired temperature.

The selected temperature is marked with a frame.

Selecting the spin speed

You can alter the preset spin speed.

- Touch the *Spin speed* 🌀 sensor.

The following will appear in the display:

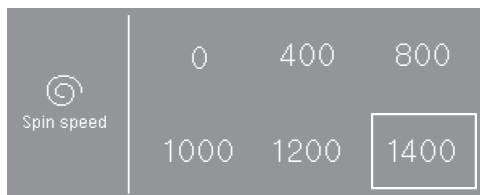

- Select the desired spin speed.

The selected spin speed is marked with a frame.

4. Selecting programme settings

Selecting Extras

You can select Extras for the wash programmes.

For some programmes, an Extra is offered directly in the main menu.

- Touch the sensor of the Extra to activate it.

For some programmes, you select Extras in the *Extras* submenu.

- Touch the *Extras*  sensor.

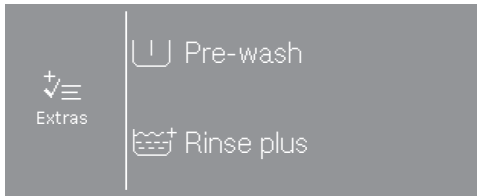

- Select one or two of the available Extras in succession.

Not all Extras can be selected with every programme. If an Extra is not listed, it is not permitted for use with this wash programme.

Selecting further options

You can select a delay start time or change the settings of the washing machine.

- Touch the *Further selections*  sensor.

The following will appear in the display:



- Select the desired option.

The display will change to the submenu for that option.

Delay start is not possible for some programmes.

5. Adding detergent

There are several options for adding detergent.

Detergent dispenser drawer

Any detergent suitable for automatic front loading washing machines can be used with this appliance.

Detergent dispensing

Please follow the detergent manufacturer's instructions in relation to dosage.

Adding too much detergent will lead to excessive foaming.
Avoid adding excess detergent.

The amount to dispense will depend on:

- the amount of laundry
- the degree of soiling of the laundry
- the water hardness

| Water hardness range | Hardness in mmol/l | German scale °dH |
|----------------------|--------------------|------------------|
| soft (I) | 0-1.5 | 0-8.4 |
| medium (II) | 1.5-2.5 | 8.4-14 |
| hard (III) | above 2.5 | above 14 |

Check with your local water supplier if you do not know the water hardness in your area.

Adding detergent

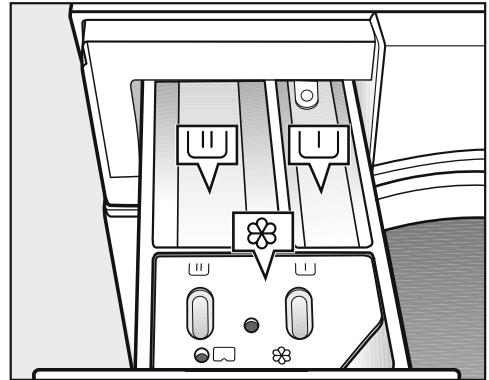

- Pull out the detergent dispenser drawer and add detergent to the compartments.

- U Detergent for the pre-wash (divide the total recommended amount as follows: 1/3 to compartment U and 2/3 to compartment U)
- U Detergent for the main wash
- ⊗ Fabric softener or liquid starch

For disinfection programmes, the U and U compartments can be filled with detergent for the main wash if you have not selected Pre-wash.

5. Adding detergent

Adding fabric softener or liquid starch separately

- Select the *Separate rinse* programme.
- Change the spin speed if necessary.

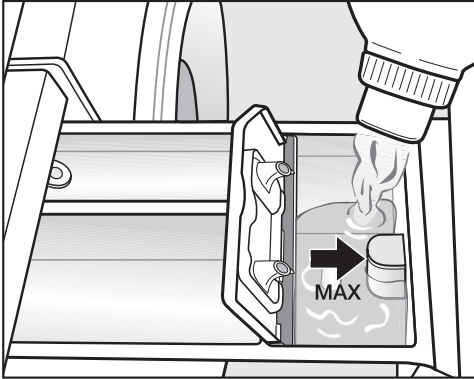

- Add the fabric softener or the liquid starch to the ☼ compartment. **Do not exceed the maximum level mark.**
- Touch the *Start/Stop* sensor.

This will be automatically dispensed in the final rinse. At the end of the wash programme a small amount of water remains in the ☼ compartment.

Dye removers and dyes

⚠ Damage due to colour run/dye removers.

Colour run and dye removers can cause corrosion in the washing machine.

Do not use colour run or dye removers in this washing machine.

Only use dyes suitable for use in a washing machine. The manufacturer's instructions on the packaging must be observed.

External dispensing

The washing machine is pre-equipped for connection to an external detergent dispensing system. A separate conversion kit for external dispensing systems is required. This must be fitted by a Miele authorised service technician.

6. Starting the programme - the end of the programme

Starting a programme

The programme can be started once the *Start/Stop* sensor is flashing on and off.

- Touch the *Start/Stop* sensor.

The door will lock (🔒 symbol) and the wash programme will start.

If a delay start time has been selected, this will count down in the display until the programme starts.

At the end of the delay start time or immediately after the programme has started, the programme duration will appear in the display. The programme sequence is also shown in the display.

Useful tip: Touch the **i** sensor control to display the set temperature, spin speed and any set Extras.

At the end of the programme

The door remains locked during the anti-crease phase. However, the door can be unlocked at any time by touching the *Start/Stop* sensor.

Removing the laundry

- Pull open the door.
- Remove the laundry.

Items left in the drum could discolour other items in the next wash or become discoloured themselves. Remove all items from the drum.

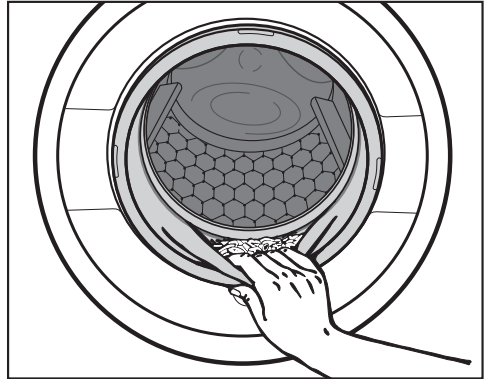

- Check the folds in the door seal for any small articles, e.g. buttons, which might be lodged there.





Useful tip: For safety reasons, close the door when the washing machine is not in use. Otherwise there is a danger of objects being placed inadvertently in the drum. If these remain unnoticed and were washed in the next load, they could damage the laundry. An open door is also a danger to pets and children.

- Switch the washing machine off with the **⏻** button.

Useful tip: Leave the detergent dispenser drawer slightly open to allow it to dry.

The Delay start function can be used to set the time until the programme starts or the programme finish time (see “Supervisor level - Delay start”).

Selecting Delay start

- Touch the *Further selections*  sensor.
- Select the Finish at , Start at  or Start in  option.
- Use the \wedge and \vee sensors to enter the hours and minutes and confirm your entry with the *OK* sensor.

The minutes entry moves to the next “full quarter of an hour” and can then be adjusted in 15-minute increments.

Starting Delay start

- Touch the *Start/Stop* sensor.

The door will lock and the time remaining until the programme starts will appear in the display.

Cancelling or changing Delay start

- Touch the *Start/Stop* sensor.

The following will appear in the display:

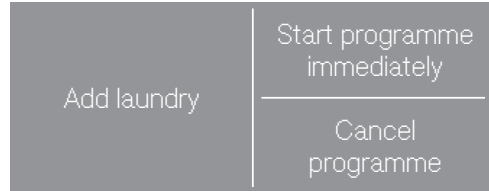

- Touch the *Start programme immediately* sensor.

The wash programmes starts immediately.

or













- Touch the *Cancel programme* sensor.

The programme start is cancelled and the *Start/Stop* button flashes on and off.

Programme chart

Mop programmes









- A pre-spin* and a pre-rinse cycle are carried out before the main wash.

| | | |
|---|--|-------------------------|
|  Mops 60°C | | Max. load 8.0 kg |
| Items | Cotton, mixed fibre or microfibre mops | |
| Notes | Use specialist detergents. | |
| 1400 rpm | Extras: 2nd Pre-rinse  , Microfibre  | Rinse cycles: 2-5* |
|  Mops plus 40°C to 90°C | | Max. load 8.0 kg |
| Items | Cotton, mixed fibre or microfibre mops | |
| Notes | <ul style="list-style-type: none"> - Use specialist detergents. - The pre-set temperature can be altered.* | |
| 1400 rpm | Extras: 2nd Pre-rinse  , Microfibre  | Rinse cycles: 2-5* |
|  Thermal disinfection 85°C/15 min | | Max. load 8.0 kg |
| Items | Cotton, mixed fibre or microfibre mops | |
| Notes | <ul style="list-style-type: none"> - Further disinfection methods can be selected.* - Use powder detergent containing a bleaching agent. | |
| 1400 rpm | Extras: 2nd Pre-rinse  , Microfibre  | Rinse cycles: 3-6* |
|  Chemo-therm. disinfection 60°C/20 min | | Max. load 8.0 kg |
| Items | Cotton, mixed fibre or microfibre mops | |
| Notes | <ul style="list-style-type: none"> - Further disinfection methods can be selected.* - Use specialist detergents. Observe the country-specific guidelines for disinfection. | |
| 1400 rpm | Extras: 2nd Pre-rinse  , Microfibre  | Rinse cycles: 3-6* |

* Settings can be altered in the Supervisor level.



Cloths programmes

- A pre-rinse cycle is carried out before the main wash.

| | | |
|---|--|-------------------------|
|  Cloths 60°C | | Max. load 4.0 kg |
| Items | Cotton, mixed fibre or microfibre cloths | |
| Notes | Use specialist detergents. | |
| 1400 rpm | Extras: Pre-wash  | Rinse cycles: 2-5* |
|  Cloths plus 40°C to 90°C | | Max. load 4.0 kg |
| Items | Cotton, mixed fibre or microfibre cloths | |
| Notes | <ul style="list-style-type: none"> - Use specialist detergents. - The pre-set temperature can be altered.* | |
| 1400 rpm | Extras: Pre-wash  | Rinse cycles: 2-5* |
|  Thermal disinfection 85°C/15 min | | Max. load 4.0 kg |
| Items | Cotton, mixed fibre or microfibre cloths | |
| Notes | Use specialist detergents. | |
| 1400 rpm | Extras: Pre-wash  | Rinse cycles: 3-6* |
|  Chemo-therm. disinfection 70°C/10 min | | Max. load 4.0 kg |
| Items | Cotton, mixed fibre or microfibre cloths | |
| Notes | <ul style="list-style-type: none"> - Further disinfection methods can be selected.* - Use specialist detergents. Observe the country-specific guidelines for disinfection. | |
| 1400 rpm | Extras: Pre-wash  | Rinse cycles: 3-6* |

* Settings can be altered in the Supervisor level.

Programme chart

| | | |
|---|--|-------------------------|
| Cottons PRO 60°C | | Max. load 8.0 kg |
| Items | Mixed fibre textiles (50% cotton and 50% polyester) | |
| Notes | - Extra energy-efficient wash programme for commercial cotton or cotton/synthetic blend textiles with moderate levels of soiling, e.g. workwear. | |
| 1400 rpm | Extras: Pre-wash  | Rinse cycles: 2 |
|  Pads 40°C | | Max. load 1.5 kg |
| Items | Microfibre polishing pads and buffers | |
| Notes | - A pre-rinse cycle is carried out before the main wash. - Use specialist detergents. | |
| 1400 rpm | Extras: 2nd Pre-rinse  | Rinse cycles: 3 |



Programme packages

You can select various programmes packages. The programmes selected from the programme packages are displayed under the *Further programmes* list.

Standard

| | | |
|------------------------------|---|-------------------------|
| New mops 60°C to 90°C | | Max. load 8.0 kg |
| Items | Cotton, mixed fibre or microfibre mops | |
| Notes | - For washing new mops before first use. Manufacturing residues are washed out of the fibres. This increases the amount of water absorbed by the fibres when mopping. - Use universal or colour detergents. - Do not use fabric softener. | |
| 1400 rpm | Extras: Microfibre  | Rinse cycles: 2 |











Programme chart

| | | |
|------------------------------|--|-------------------------|
| Curtains cold to 40°C | | Max. load 3.0 kg |
| Items | Curtains specified as machine-washable by the manufacturer | |
| Notes | <ul style="list-style-type: none"> - A pre-rinse cycle is carried out before the main wash. - For curtains which crease easily, deselect the spin speed. | |
| 600 rpm | Extras: Pre-wash  | Rinse cycles: 3 |
| Separate rinse | | Max. load 8.0 kg |
| Items | Fabrics that only need to be rinsed and spun | |
| Notes | <ul style="list-style-type: none"> - For rinsing residual detergent. - For removing coarse soiling before the main wash. - Make sure you select the appropriate spin speed. | |
| 1400 rpm | | Rinse cycles: 2 |
| Drain/Spin | | Max. load 8.0 kg |
| Notes | Make sure you select the appropriate spin speed. | |
| 1400 rpm | | |
| Clean machine 70°C | | No load |
| | <p>For cleaning the suds container and the drainage system.</p> <ul style="list-style-type: none"> - Add universal detergent to the  compartment. - Use the <i>Clean machine</i> programme regularly if you frequently use disinfection programmes. | |

Programme chart

Pre-treat mops programmes (ready to use - rtu)

- Mops are washed and pre-treated in one cycle.
- A pre-spin* and a pre-rinse cycle are carried out before the main wash.
- There is no water intake via the fabric softener compartment during the disinfection process.







| | | |
|---|--|-------------------------|
| Mops +rtu 60°C | | Max. load 8.0 kg |
| Items | Cotton, mixed fibre or microfibre mops | |
| Notes | Add the pre-treating agent via the fabric softener compartment or the external dispensing system. | |
| 0-60 sec | Extras: 2nd Pre-rinse  , Microfibre  | Rinse cycles: 2-5* |
| Mops plus + rtu 40°C to 90°C | | Max. load 8.0 kg |
| Items | Cotton, mixed fibre or microfibre mops | |
| Notes | Add the pre-treating agent via the fabric softener compartment or the external dispensing system. | |
| 0-60 sec | Extras: 2nd Pre-rinse  , Microfibre  | Rinse cycles: 2-5* |
|  Disinfect mops + rtu 85°C | | Max. load 8.0 kg |
| Items | Cotton, mixed fibre or microfibre mops | |
| Notes | <ul style="list-style-type: none"> - Further disinfection methods can be selected.* - Use powder detergent containing a bleaching agent. | |
| 0-60 sec | Extras: 2nd Pre-rinse  , Microfibre  | Rinse cycles: 3-6* |
|  Disinfect mops + rtu 70°C | | Max. load 8.0 kg |
| Items | Cotton, mixed fibre or microfibre mops | |
| Notes | <ul style="list-style-type: none"> - Further disinfection methods can be selected.* - Use specialist detergents. Observe the country-specific guidelines for disinfection. | |
| 0-60 sec | Extras: 2nd Pre-rinse  , Microfibre  | Rinse cycles: 3-6* |
| Mops rtu | | Max. load 8.0 kg |
| Items | Cotton, mixed fibre or microfibre mops | |
| Notes | <ul style="list-style-type: none"> - For pre-treating clean mops. - Add the pre-treating agent via the fabric softener compartment or the external dispensing system. | |
| 0-60 sec | | Rinse cycles: 1 |

* Settings can be altered in the Supervisor level.

Programme chart

Pre-treat cloths programmes (ready to use - rtu)

- Cleaning cloths are washed and pre-treated in one cycle.
- A pre-rinse cycle is carried out before the main wash.
- There is no water intake via the fabric softener compartment during the disinfection process.



| Cloths + rtu 60°C | | Max. load 4.0 kg |
|---|--|-------------------------|
| Items | Cotton, mixed fibre or microfibre cloths | |
| Notes | Add the pre-treating agent via the fabric softener compartment or the external dispensing system. | |
| 0-60 sec | Extras: Pre-wash  | Rinse cycles: 2-5* |
| Cloths plus + rtu 40°C to 90°C | | Max. load 4.0 kg |
| Items | Cotton, mixed fibre or microfibre cloths | |
| Notes | Add the pre-treating agent via the fabric softener compartment or the external dispensing system. | |
| 0-60 sec | Extras: Pre-wash  | Rinse cycles: 2-5* |
|  Disinfect cleaning cloths + rtu 85°C | | Max. load 4.0 kg |
| Items | Cotton, mixed fibre or microfibre cloths | |
| Notes | <ul style="list-style-type: none"> - Further disinfection methods can be selected.* - Use specialist detergents. | |
| 0-60 sec | Extras: Pre-wash  | Rinse cycles: 3-6* |
|  Disinfect cleaning cloths+ rtu 70°C | | Max. load 4.0 kg |
| Items | Cotton, mixed fibre and microfibre cloths | |
| Notes | <ul style="list-style-type: none"> - Further disinfection methods can be selected.* - Use specialist detergents. Observe the country-specific guidelines for disinfection. | |
| 0-60 sec | Extras: Pre-wash  | Rinse cycles: 3-6* |
| Cloths rtu | | Max. load 4.0 kg |
| Items | Cotton, mixed fibre or microfibre cloths | |
| Notes | <ul style="list-style-type: none"> - For pre-treating clean cleaning cloths. - Add the pre-treating agent via the fabric softener compartment or the external dispensing system. | |
| 0-60 sec | Extras: Pre-wash  | Rinse cycles: 1 |

* Settings can be altered in the Supervisor level.

Programme chart

Ready to use (rtu)





- The residual moisture after pre-treatment is selected with the $\delta\text{---}\delta$ sensor control.

| Mops + rtu $\delta\text{---}\delta$ 40°C to 90°C | | Max. load 8.0 kg |
|--|--|-------------------------|
| Items | Cotton, mixed fibre or microfibre mops | |
| Notes | <ul style="list-style-type: none"> - Mops are washed and finished in one cycle. - A pre-spin* and a pre-rinse cycle are carried out before the main wash. - Add the pre-treating agent via the fabric softener compartment or the external dispensing system. | |
| $\delta\text{---}\delta\delta\delta\delta$ | Extras: Pre-rinse  , Microfibre  | Rinse cycles: 2-5* |
| Mops rtu $\delta\text{---}\delta$ cold | | Max. load 8.0 kg |
| Items | Cotton, mixed fibre or microfibre mops | |
| Notes | <ul style="list-style-type: none"> - For finishing clean mops. - Add the pre-treating agent via the fabric softener compartment or the external dispensing system. | |
| $\delta\text{---}\delta\delta\delta\delta$ | | Rinse cycles: 1 |

* Settings can be altered in the Supervisor level.







Programme chart

Workwear

| | | |
|--|--|-------------------------|
| Oil/fat special 60°C to 90°C | | Max. load 8.0 kg |
| Items | Work coats, work jackets, hats, cleaning cloths made from cotton or mixed fibres | |
| Notes | <ul style="list-style-type: none"> - Activate Pre-wash for heavy soiling. - Use liquid detergent. | |
| 1400 rpm | Extras: Pre-wash  | Rinse cycles: 3 |
| Dust/flour special 40°C to 90°C | | Max. load 8.0 kg |
| Items | Cotton or mixed fibre workwear, table cloths, or cleaning cloths soiled with dust or flour | |
| Notes | <ul style="list-style-type: none"> - The automatic pre-rinse removes any coarse soiling. Add a second pre-rinse for very heavy levels of soiling. - Select Pre-wash for stubborn stains. | |
| 1400 rpm | Extras: Pre-wash  , Pre-rinse  | Rinse cycles: 3 |
| Intensive wash 60°C to 90°C | | Max. load 8.0 kg |
| Items | Heavily soiled workwear made from cotton, linen, and mixed fibres | |
| Notes | A particularly good wash and rinse result is achieved by a high water level. | |
| 1400 rpm | Extras: Pre-wash  | Rinse cycles: 2 |

Programme chart

Standard programmes

| | | |
|--|---|-------------------------|
| White items 90°C | | Max. load 8.0 kg |
| Items | Cotton, linen, and mixed fibre textiles | |
| Notes | An additional pre-rinse can be programmed.* | |
| 1400 rpm | Extras: Pre-wash  | Rinse cycles: 2-5* |
| Coloured items 30°C to 60°C | | Max. load 8.0 kg |
| Items | Cotton, linen, and mixed fibre textiles | |
| Notes | <ul style="list-style-type: none"> - For dark coloured fabrics use a colour detergent or liquid detergent. - An additional pre-rinse can be programmed.* | |
| 1400 rpm | Extras: Pre-wash  | Rinse cycles: 2-5* |
| Minimum iron 30°C to 60°C | | Max. load 4.0 kg |
| Items | Synthetic, mixed fibre and easy care cotton fabrics | |
| Notes | <ul style="list-style-type: none"> - Reduce the final spin speed for fabrics which crease easily. - An additional pre-rinse can be programmed.* | |
| 1200 rpm | Extras: Pre-wash  | Rinse cycles: 2-4* |
| Express 20°C to 60°C | | Max. load 4.0 kg |
| Items | Cotton garments that have hardly been worn or are only very lightly soiled | |
| 1400 rpm | Extras: Rinse plus  | Rinse cycles: 1 |
| Lightweight curtains cold to 40°C | | Max. load 3.0 kg |
| Items | Curtains specified as machine-washable by the manufacturer | |
| Notes | For curtains which crease easily, deselect the spin speed. | |
| 600 rpm | Extras: Pre-wash  , Rinse plus  | Rinse cycles: 2 |

* Settings can be altered in the Supervisor level.

You can supplement the wash programmes with Extras.

Not all Extras can be selected with every programme. If an Extra is not listed, it is not permitted for use with this wash programme.

Selecting Extras

For some programmes, an Extra is offered directly in the main menu.

- Touch the sensor of the Extra to activate it.

For some programmes, Extras are selected in the *Extras* submenu.

- Touch the *Extras*  sensor.
- Select one or two of the Extras available.

Pre-wash

A pre-wash can be added for heavily soiled laundry. Coarse soiling is loosened and removed before the main wash.

Pre-rinse

The laundry is rinsed before the main wash to remove larger quantities of soiling, e.g. dust, sand.

Rinse plus

An additional rinse cycle can be activated to achieve a particularly good wash result.

Microfibre

Microfibre mops are gently cooled at the end of the main wash cycle.

Special features in the programme sequence

Spinning

Final spin speed

When a programme is selected, the maximum spin speed for this wash programme is shown in the display.

You can reduce the final spin speed.

However, you cannot select a final spin speed higher than that shown in the chart.

Interim spin



There is a spin cycle after the main wash and between the rinses. A reduction in the final spin speed will also reduce the interim spin speed accordingly.

Deselecting the interim spin and the final spin

- Select the programme setting *Spin speed 0*.

After the last rinse cycle, the water will be pumped away and the anti-crease phase will switch on.

Spinning for mop and cleaning cloth programmes

In pre-treat programmes for mops and cleaning cloths, the residual moisture of the load can be set using either the *Spin duration*  or the *Residual moisture*  sensor control. The stored spin speeds can be altered (see “Supervisor level”).

Anti-crease

At the end of the programme, the drum continues to turn at intervals for up to 30 minutes to help prevent creasing. The door can be opened at any time during the anti-crease phase.

There is no anti-crease phase at the end of some programmes.

Changing the programme sequence

Changing a programme

After the start of a programme, it is no longer possible to select a different programme.

You will need to cancel the current programme before you can select a different one.

If the programme selector is changed, Programme change not possible will appear in the display. The text disappears when the programme selector is set to the original programme.

Cancelling a programme

You can cancel a programme at any time after it has started.

Disinfection programmes can only be cancelled with a PIN code.

- Touch the *Start/Stop* sensor.
- Select *Cancel programme*.

The suds will be pumped away. The programme is cancelled. The door lock is released.

- Pull open the door.
- Remove the laundry.

If you want to select a different programme:

- Close the door.
- Select the required programme.
- Add detergent to the detergent dispenser drawer, if necessary.
- Touch the *Start/Stop* sensor.

The new programme will start.

Switching on the washing machine after an interruption to the power supply

If the washing machine is switched off with the Ⓛ button during a wash programme, the programme will be interrupted.

- Switch it back on with the Ⓛ button.
- Note the message in the display.
- Touch the *Start/Stop* sensor.

The programme will also be interrupted if power is interrupted by a power cut.

- When power is restored, confirm the message in the display with *OK*.
- Touch the *Start/Stop* sensor.

The programme will continue.

Changing the programme sequence

Adding or removing laundry

You can add or remove items during the first few minutes after the programme has started.

- Touch the *Start/Stop* sensor.

The following will appear in the display:



- Touch the *Add laundry* sensor.

The programme will stop and the door will unlock.



Risk of chemical burns from detergent.

When adding or removing laundry during the main wash, your skin may come into contact with detergent, particularly if the detergent is dispensed externally.

Take care when placing your hands inside the drum.

If suds have come into contact with the skin, rinse off immediately with lukewarm water.

- Pull open the door.
- Add laundry or remove individual items.
- Close the door.
- Touch the *Start/Stop* sensor.

The wash programme will continue.

Once a programme has started successfully, the washing machine cannot recognise any adjustment to the load.

For this reason, if laundry is added or removed after the start of a programme, the machine will always complete the programme cycle assuming a full load.

The door cannot be opened, if:

- The suds temperature is above 55°C.

The safety lock will remain activated if the temperature in the drum is above 55°C. The lock will not deactivate until the temperature has dropped to below 55°C.



Risk of electric shock!

Only ever perform cleaning and maintenance work when the appliance is disconnected from the power.

Disconnect the washing machine from the mains electricity supply.

Cleaning the external casing and fascia panel



Damage caused by cleaning agents.

Solvent based cleaning agents, abrasive cleaners, glass cleaners or multi-purpose cleaning agents can cause damage to plastic surfaces and other parts.

Do not use any of these cleaning agents.



Risk of damage due to ingress of water.

The pressure of a water jet can cause water to get into the washing machine, resulting in damage to components.

Do not spray the washing machine with a water jet.

- Clean the casing and control panel with a mild cleaning agent or soap and water and dry both with a soft cloth.
- The drum and other stainless steel parts can be cleaned using a suitable stainless steel cleaning agent.

Cleaning the detergent dispenser drawer

Washing at low temperatures and the use of liquid detergent can lead to a build-up of mould and bacteria in the detergent dispenser drawer.

- For hygiene reasons, clean the entire drawer at regular intervals.

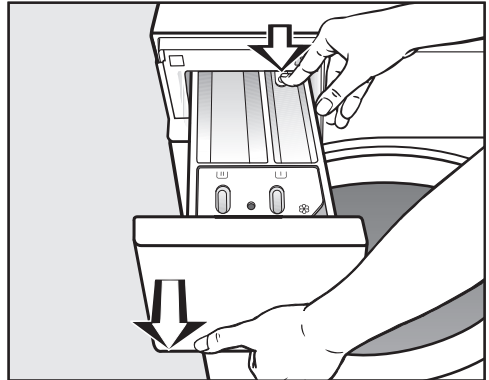

- Pull out the detergent dispenser drawer until a resistance is felt. Press down the release button and at the same time pull the drawer right out of the machine.
- Clean the detergent dispenser drawer with warm water.

Cleaning and care

Cleaning the siphon and the channel

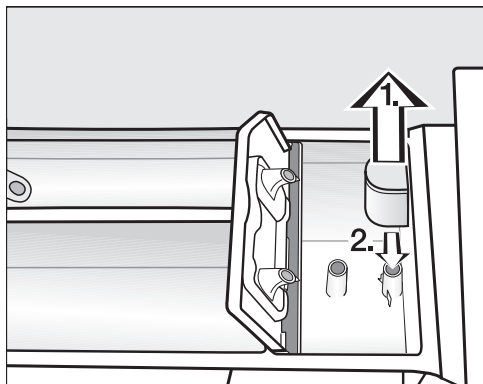

- Pull the siphon out of the ☸ compartment. Clean the siphon under warm running water. Clean the siphon tube in the same way.
- Refit the siphon.

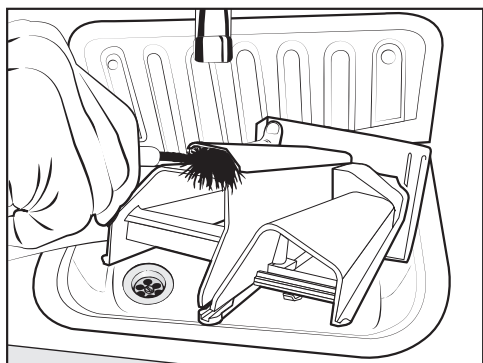

- Clean the fabric softener channel using a brush and warm water.

Cleaning the detergent dispenser drawer housing

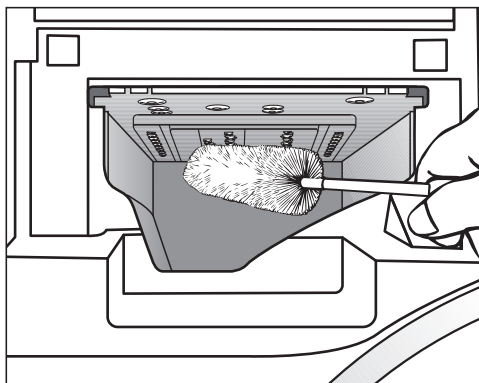

- Use a bottle brush to remove detergent residues and limescale from the jets inside the detergent dispenser drawer housing.
- Replace the detergent dispenser drawer.

Useful tip: Leave the detergent dispenser drawer slightly open to allow it to dry.

Cleaning the drum, suds container and drainage system

By using wash programmes of 60°C or more on a regular basis and using a multi-purpose detergent, you can avoid the build-up of bacteria in the washing machine.

Regularly use the *Clean machine* programme, especially if you frequently use wash programmes with low temperatures.

Optimum results can be achieved by using a machine cleaner. Alternatively, a multi-purpose powder detergent can be used.

- Start the *Clean machine* programme.
- Dispense the machine cleaner or multi-purpose detergent directly into the drum.
- Do **not** load any laundry. The drum must be empty for the cleaning process.
- At the end of the programme, check the inner drum and remove any coarse residues.

Use the *Clean machine* programme regularly if you frequently use disinfection programmes.

Cleaning the sealing ring

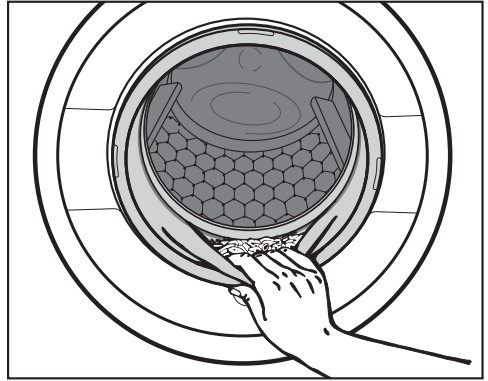

- Check the fold in the sealing ring for foreign objects.
- Clean the sealing ring and the inner fold of the sealing ring with a damp cloth.

Useful tip: For safety reasons, close the door when the machine is not in use. Otherwise there is a danger of objects being placed inadvertently in the drum. If these remain unnoticed and were washed in the next load, they could damage the laundry. An open door is also a danger to pets and children.

Cleaning and care

Cleaning the filters in the water inlet

The washing machine has filters to protect the water inlet valves. Check these filters about every 6 months or more often if there are frequent interruptions to the external water supply.

Cleaning the filters in the inlet hoses

- First turn off the tap.
- Unscrew the inlet hose.
- Remove the rubber seal from the recess.
- Using combination or pointed pliers, take hold of the plastic filter bar and remove the filter.
- Clean the plastic filter.
- Reassemble the filter and seal in the reverse order and reconnect the hose.

Make sure there is no water leaking from the threaded union.
Tighten the threaded union.

Cleaning the filters in the water inlet valves

- Using pliers, carefully loosen the ribbed plastic nut on the inlet valve and unscrew.

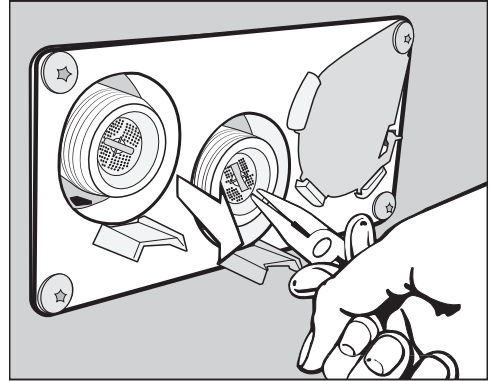

- Withdraw the filter at the bar with pointed pliers and rinse it clean under running water. Reassemble the filter and seal in the reverse order and reconnect the hose.

Replace the filters after cleaning.

With the help of the following guide, minor faults in the performance of the appliance, some of which may result from incorrect operation, can be remedied without contacting Miele. This will save you time and money because you will not need a service call.





Please note, however, that a call-out charge will be applied to unnecessary service visits where the problem could have been rectified as described in these operating instructions.

The programme does not start

| Problem | Possible cause and remedy |
|--|--|
| <p>The display remains dark and the <i>Start/Stop</i> sensor does not light up or flash.</p> | <p>There is no power to the machine.</p> <ul style="list-style-type: none"> ■ Check whether the washing machine is switched on. ■ Check whether the washing machine is connected to the electricity supply. ■ Check whether the circuit breaker has tripped. <hr/> <p>The washing machine has switched off automatically to save energy.</p> <ul style="list-style-type: none"> ■ Switch it back on with the ⓘ button. |
| <p>The following appears in the display:  Door will not lock. Call Miele.</p> | <p>The door is not closed properly. The door lock could not engage.</p> <ul style="list-style-type: none"> ■ Close the door again. ■ Start the programme again. <p>If the fault message appears again, contact Miele.</p> |
| <p>The programme does not start when <i>Spin</i> is selected.</p> | <p>You have not yet completed the initial commissioning process.</p> <ul style="list-style-type: none"> ■ Follow the instructions in the section <i>Completing the commissioning process</i> in these instructions. |
| <p>The display is dark and the <i>Start/Stop</i> sensor is flashing slowly.</p> | <p>The display has switched off automatically to save energy.</p> <ul style="list-style-type: none"> ■ Touch any sensor. The display will switch on again. |

Problem solving guide

Programme cancellations and fault messages

| Problem | Possible cause and remedy |
|--|---|
|  Water drainage fault. | The water outlet is blocked or restricted. ■ Call Miele. |
|  Water intake fault. Turn on the tap. | The water inlet is blocked or restricted. ■ Check whether the tap is turned on properly. ■ Check whether the inlet hose is kinked. |
| | The water pressure is too low. ■ Switch on the Low water pressure setting (see “Supervisor level - Low water pressure”). |
| | The filters in the water inlet are blocked. ■ Clean the filters (see “Cleaning and care - Cleaning the filters”). |
|  Waterproof system activated | The water protection system has reacted. ■ Turn off the tap. ■ Call Miele. |
|  Disinfection temperature not reached | The required temperature was not reached during the disinfection programme. ■ The washing machine has not carried out the disinfection cycle correctly. ■ Start the programme again. |
|  Fault F. If restart fails, call Miele. | There is a fault. ■ Disconnect the washing machine from the mains electricity supply. ■ Wait at least 2 minutes before reconnecting the washing machine to the electricity. ■ Then switch the washing machine on again. ■ Start the programme again. If the fault message appears again, contact Miele. |

A fault message appears in the display¹

| Problem | Possible cause and remedy |
|--|---|
| i Dispenser container empty | One of the detergent containers for external dosing is empty. ■ Refill the detergent containers. |
| i Container 1 empty | External detergent container 1 is almost empty. The message can refer to containers 1 to 6. ■ Refill the detergent container. ■ Reset the container's early-warning counter (see "Supervisor level - Early-warning counter"). |
| i Check hot water intake | The hot water supply is blocked or restricted. ■ Check whether the hot water tap is turned on properly. ■ Check whether the inlet hose is kinked. |
| i Align the machine. Laundry not properly spun. | The selected spin speed was not reached during the final spin due to excessive imbalance. ■ Check that the washing machine is standing level. ■ Start the spin cycle again. |
| i Machine is leaking | The washing machine or the drain valve is leaking. ■ Turn off the tap. ■ Call Miele. |



¹ The messages will appear at the end of the programme and when the washing machine is switched on and need to be confirmed with the OK sensor.

Problem solving guide

An unsatisfactory wash result



| Problem | Possible cause and remedy |
|---|--|
| Liquid detergent does not give the required result. | <p>Liquid detergents usually contain no bleaching agents. They do not remove fruit, coffee and tea stains.</p> <ul style="list-style-type: none">■ Use a general purpose powder detergent containing a bleaching agent.■ Add stain removers to compartment  of the detergent dispenser drawer and fill liquid detergent into a dispenser ball.■ Never put stain removers and liquid detergent together in the dispenser drawer. |
| White residues which look like powder detergent are seen on dark textiles after washing. | <p>The detergent contains compounds (zeolites) to aid water softening which are not soluble in water. These have ended up on the laundry.</p> <ul style="list-style-type: none">■ Try to brush off the residues with a soft brush once the laundry is dry.■ Wash dark textiles using a detergent which contains no zeolites. Liquid detergents do not usually contain zeolites. |
| Textiles that were very greasy are not properly clean. | <ul style="list-style-type: none">■ Select a programme with pre-wash. Use liquid detergent for the pre-wash.■ Continue to use universal powder detergent for the main wash. <p>The use of heavy-duty detergent is recommended in the main wash for very heavily soiled work clothing. Please seek advice from the detergent manufacturer.</p> |
| Grey, greasy particles cling to washed laundry. | <p>Insufficient amounts of detergent were used. The laundry was heavily soiled with grease (oils, ointments).</p> <ul style="list-style-type: none">■ Use more detergent or liquid detergent with this type of soiled laundry.■ Before washing the next load, run a 60°C programme with liquid detergent but without a load. |

General problems with the washing machine

| Problem | Possible cause and remedy |
|--|--|
| The machine shakes during the spin cycle. | The machine feet are not level. <ul style="list-style-type: none"> ■ Level the machine and adjust the feet correctly. |
| Large amounts of detergent residue remain in the detergent dispenser drawer. | The water pressure is too low. <ul style="list-style-type: none"> ■ Clean the filters in the water inlet. |
| | Powder detergent used in conjunction with water softeners tends to become sticky. <ul style="list-style-type: none"> ■ Clean the detergent dispenser drawer and, in the future, add washing powder to the dispensing drawer first, and then add the water softener. |
| Fabric softener is not completely dispensed or too much water remains in the  compartment. | The siphon tube is not correctly positioned or clogged. <ul style="list-style-type: none"> ■ Clean the siphon (see “Cleaning and care - Cleaning the detergent dispenser drawer”). |
| The display is in a different language. | A different language has been selected. <ul style="list-style-type: none"> ■ Switch the washing machine off and then on again. <p>The set operator language will appear in the display.</p> |
| | The operator language has been changed. <ul style="list-style-type: none"> ■ Select the language you require (see “Supervisor level - Language”). |
| The washing machine did not spin the laundry as usual. The laundry is still wet. | The machine detected an imbalance during the final spin and reduced the spin speed automatically. <ul style="list-style-type: none"> ■ Include both large and small items in the load as this will give better distribution. |
| The drum remains stationary but the programme keeps running. | <ul style="list-style-type: none"> ■ Switch the washing machine off and then back on with the  button. ■ Note the message in the display. ■ Touch the <i>Start/Stop</i> sensor. <p>The programme will continue and the drum will spin.</p> |

Problem solving guide

The door will not open

| Problem | Possible cause and remedy |
|---|---|
| The door cannot be pulled open during a wash programme. | <p>The door is locked during the washing process.</p> <ul style="list-style-type: none">■ Touch the <i>Start/Stop</i> sensor.■ Select <i>Cancel programme</i> or <i>Add laundry</i>. <p>The door will unlock and you will be able to pull it open.</p> <p>The water level in the drum is too high.</p> <ul style="list-style-type: none">■ Cancel the programme. The washing machine will pump away the water. |
|  Programme cancelled appears in the display at the end of a programme or after a programme has been cancelled. | <p>For safety reasons, the door cannot be opened if the suds temperature is higher than 55°C.</p> <ul style="list-style-type: none">■ Wait until the temperature in the drum has decreased and the message has gone out in the display. |
| The following appears in the display:  The door lock is jammed. Call Miele. | <p>The door lock has jammed.</p> <ul style="list-style-type: none">■ Call Miele. |

Opening the door in the event of a blocked drain outlet and/or power cut

⚠ Risk of electric shock!
Only ever perform cleaning and maintenance work when the appliance is disconnected from the power.
Disconnect the washing machine from the mains electricity supply.

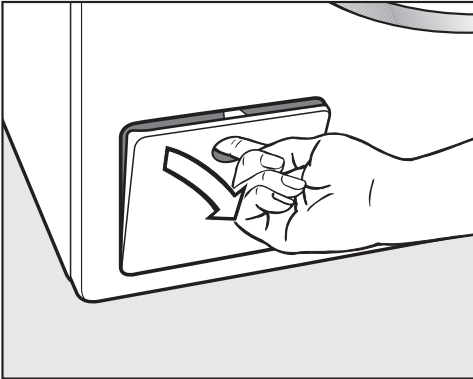

- Open the access panel to the drain system.

Blocked drain outlet

If the drain outlet is blocked, a larger quantity of water (max. 30 l) can remain in the washing machine.

⚠ Risk of scalding due to hot suds.
Escaping suds will be hot if laundry has been washed at high temperatures shortly before.
Drain the suds carefully.

Emptying the drum

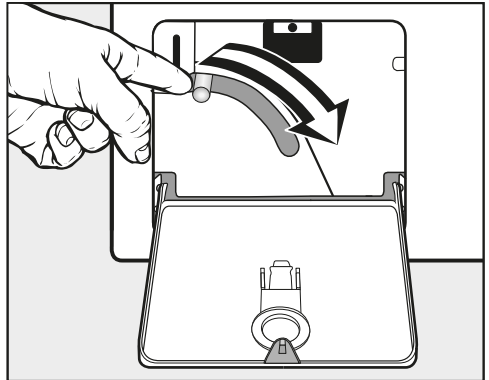

- Push the emergency drain lever downwards and hold until no more water runs out.

Problem solving guide

Opening the door

⚠ Danger of injury due to rotating drum!

Reaching into a moving drum is extremely dangerous. Danger of injury!

Always make sure that the drum is stationary before reaching in to remove laundry.

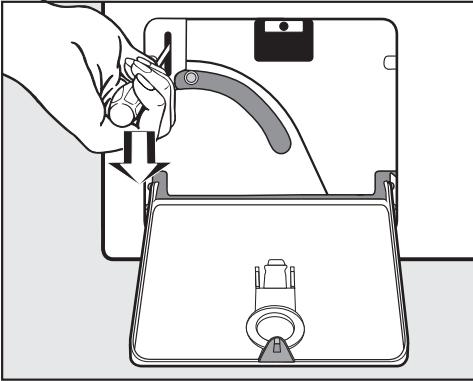

- Use a screwdriver to unlock the door of the washing machine as shown.
- Pull open the door.

Contact in case of fault

In the event of any faults which you cannot remedy yourself, please contact Miele.

Contact information for Miele can be found at the end of this booklet.

Please quote the model and serial number of your appliance when contacting Miele. This information can be found on the data plate.

The data plate is found above the porthole glass when the washing machine door is opened:

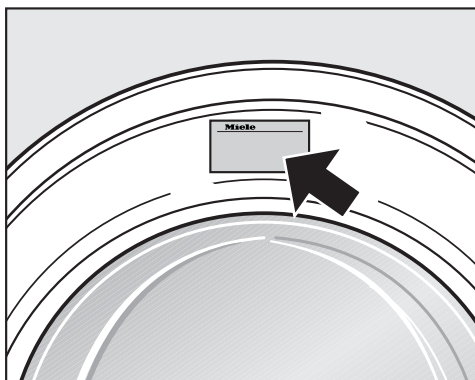

Optional accessories

Optional spare parts and accessories for this washing machine are available from Miele.

Installation

Front view

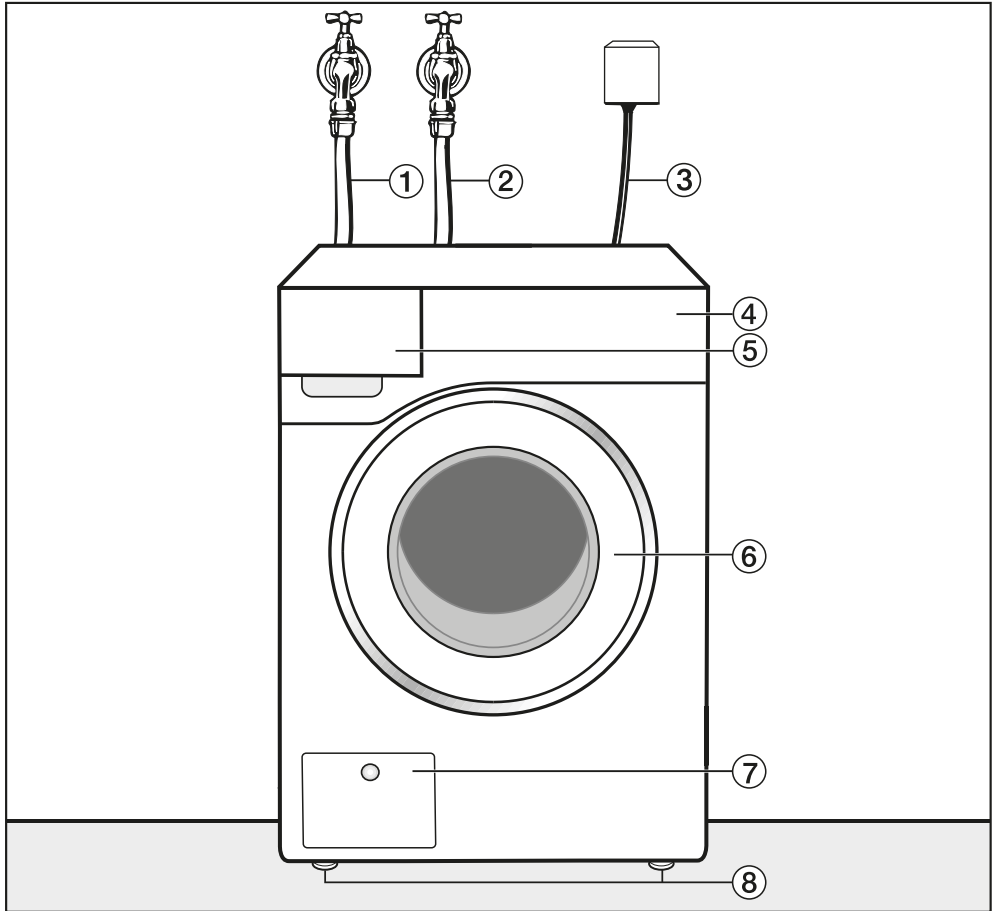

① Cold water inlet hose

② Hot water inlet hose

③ Electrical connection

④ Control panel

⑤ Detergent dispenser drawer

⑥ Door

⑦ Access to drain valve and emergency release

⑧ Height-adjustable feet

Rear view

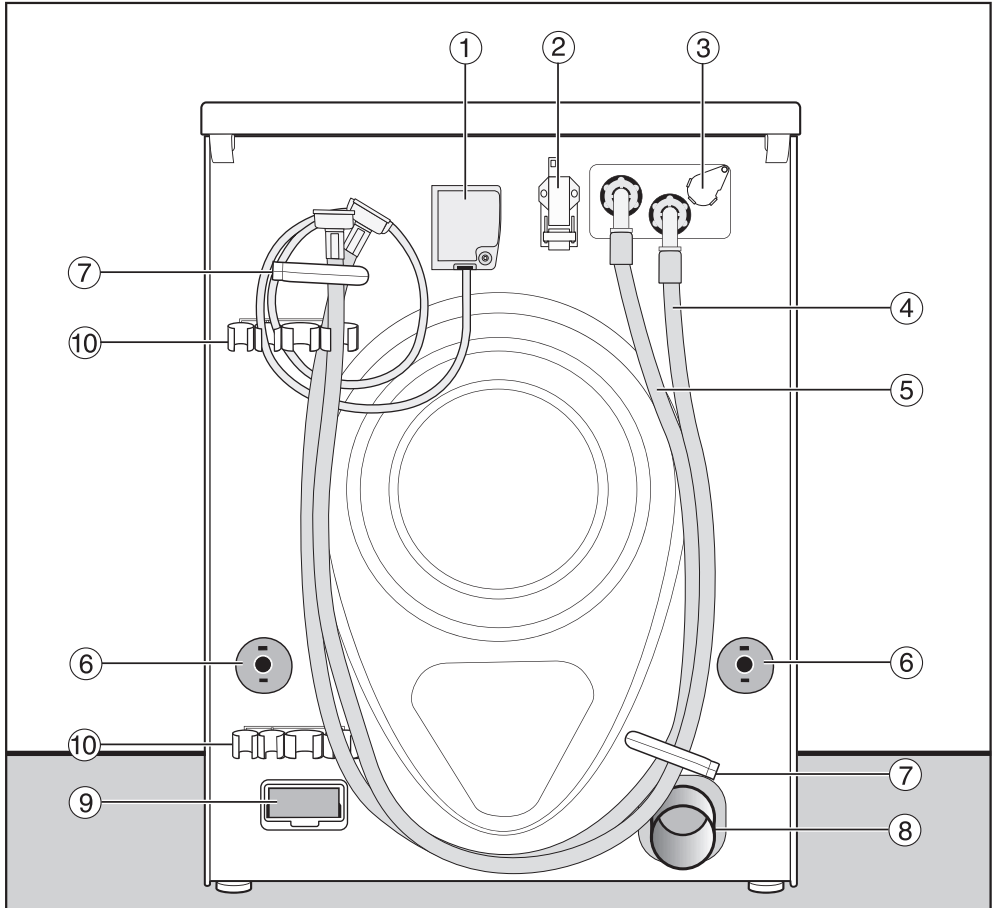

- ① Electrical connection
- ② Interface for communicating with external devices
- ③ Socket for external dispensing system
- ④ Inlet hose (cold water)
- ⑤ Inlet hose (hot water), if fitted
- ⑥ Safety caps for transit bars
- ⑦ Transport clips for hoses
- ⑧ Drain pipe
- ⑨ Module slot (for external communication module)
- ⑩ Holder for removed transit bars

Installation

Installation locations

Side view

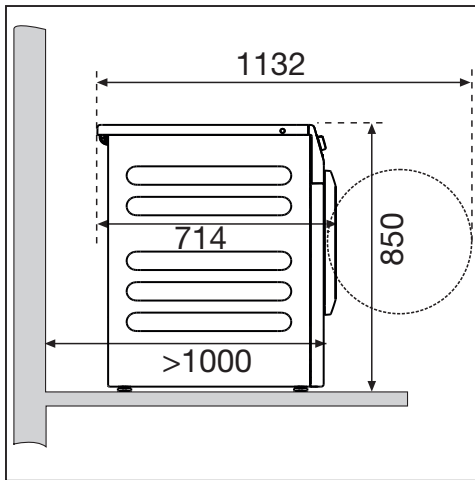

Washer-dryer stack

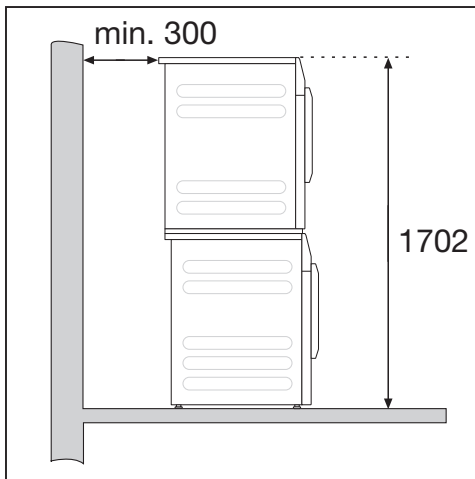

This washing machine can be installed with a Miele tumble dryer on top of it. This requires a Miele washer-dryer stacking kit which can be purchased separately.

 Installing the washer-dryer stack on a Miele plinth is not permitted.

Installation on a raised plinth

The washing machine can be installed on a steel plinth (open or closed, available as an optional Miele accessory) or on a concrete plinth.

 Injury can occur if the washing machine has not been adequately secured.

When installed on a plinth, there is a risk that the washing machine will move and fall from the plinth during spinning.

Secure the washing machine using the clamps supplied.

Installation notes

The distances between the machine and the wall are recommended for making service work easier. If installation space is limited, the washing machine can also be pushed up against the wall.

This washing machine is not suitable for building under.

 Risk of damage due to moisture ingress.

Moisture can damage electrical components.

Do not install the washing machine near or directly above an open gully or floor drain.

Transporting the washing machine to its installation site

⚠ Danger of injury from incorrect transport.

If the washing machine tips over, there is a danger of injury to people and damage to property.

When transporting the machine, make sure that it is stable.

Transporting the washing machine with a hand trolley

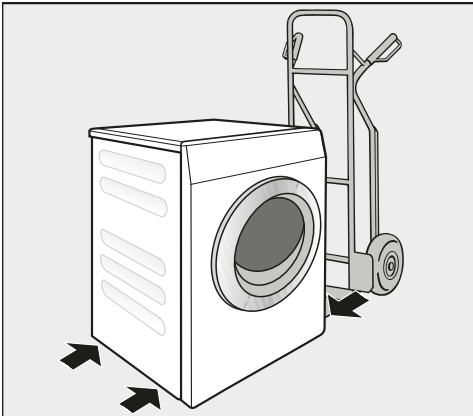

- If transporting the washing machine with a hand trolley, make sure only its left or right side is resting on the trolley.

⚠ Risk of damage from incorrect transport.

The front or back of the washing machine may be damaged if the machine is transported on a hand trolley.

Always transport the washing machine on its side on a hand trolley.

Transporting the washing machine to its installation site

The protruding lid can be used for holding the machine during transport.

⚠ Danger of injury due to unsecured lid.

Make sure the fixings at the back of the lid are secure. They may become brittle due to external circumstances. There is a danger of the lid being pulled off when carrying the appliance.

Before carrying the appliance, check that the lid is secure where it protrudes at the back.

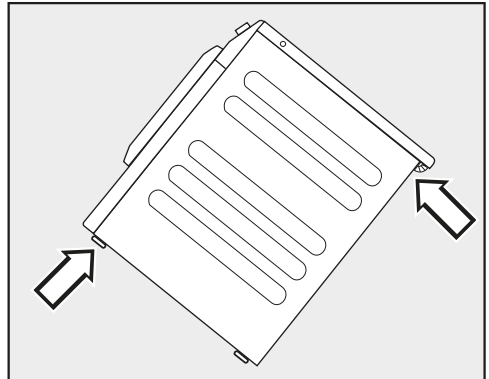

- Carry the washing machine by the front feet and by the lid where it protrudes at the back of the appliance.

Installation

Installation surface

A concrete floor is the most suitable installation surface. It is far less prone to vibration during the spin cycle than wooden floorboards or a carpeted surface.

- The machine must be level and securely positioned.
- To avoid vibrations during spinning, the machine should not be installed on soft floor coverings.

If installing on a wooden joist floor:

- Install the machine on a plywood base (at least 70 x 60 x 3 cm). The base should span several joists and be bolted to the joists and not only to the floorboards.

Useful tip: If possible, install the machine in a corner of the room. This is usually the most stable part of the floor.

Removing the transit bars

Removing the left transit bar

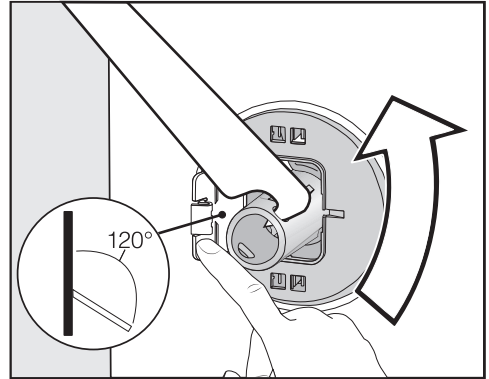

- Push the cover out and turn the transit bar 90° using the open spanner supplied.

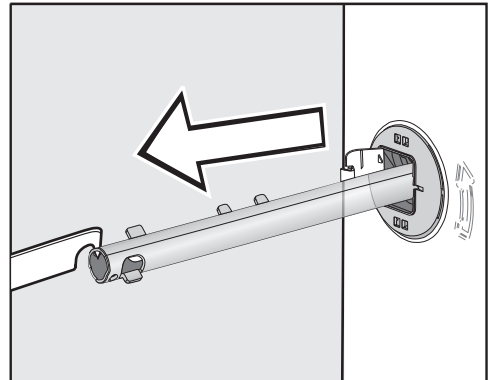

- Then pull the transit bar out.

Removing the right transit bar

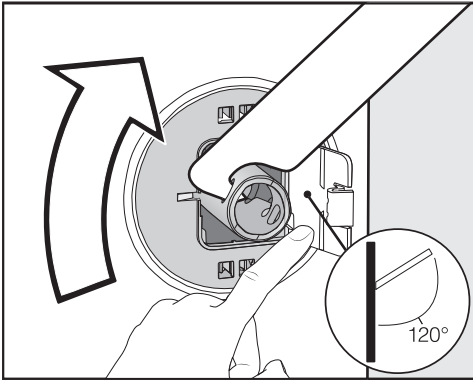

- Push the cover out and turn the transit bar 90° using the open spanner supplied.

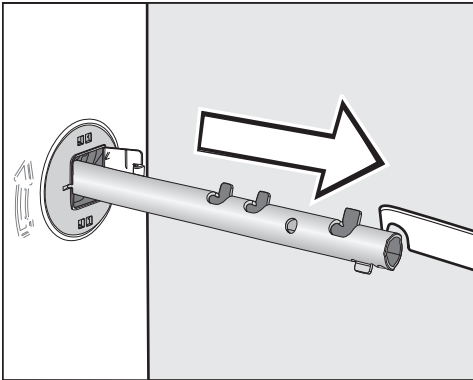

- Then pull the transit bar out.

Covering the holes

⚠ Risk of injury from sharp edges!
There is a risk of injury from reaching into holes that are not covered.
The holes for the transit bars must be covered after the transit bars have been removed.

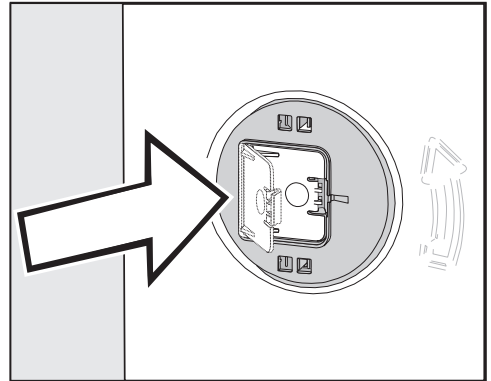

- Press the covers firmly shut until they click into place.

Installation

Securing the transit bars

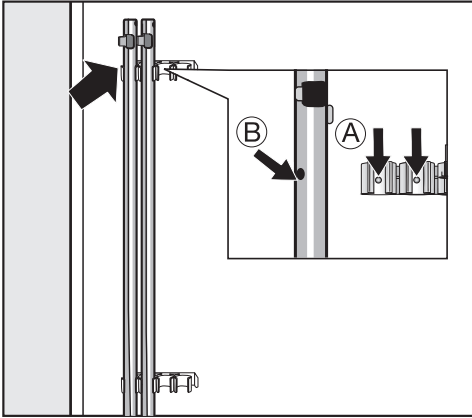

- Secure the transit bars to the back of the washing machine.

Useful tip: Make sure that the holes (B) are fitted over the retainers (A).

⚠ Risk of damage from incorrect transport.

The washing machine may be damaged if moved without the transit bars in place.

Keep the transit bars in a safe place. Fit them again if the washing machine is to be moved (e.g. when moving house).

Fitting the transit bars

Opening the flaps

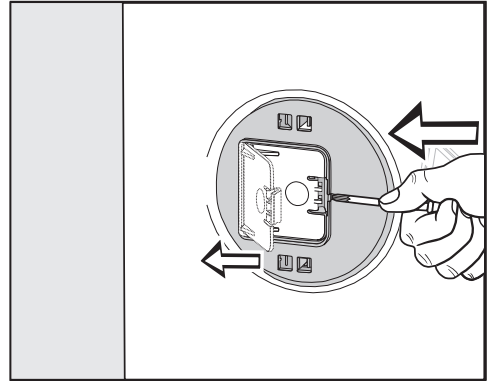

- Push against the catch with a pointed object, e.g. a narrow screwdriver.

The flap will open.

Fitting the transit bars

- Install the transit bars in reverse order to their removal.

Useful tip: If you lift the drum slightly, the transit bars can be pushed in more easily.

Aligning the washing machine

The washing machine must stand perfectly level on all four feet to ensure safe and proper operation.

Incorrect installation may increase electricity and water consumption and may cause the machine to move about.

Screwing out and adjusting the feet

The four adjustable screw feet are used for levelling the washing machine. All four feet are screwed in when the appliance is delivered.

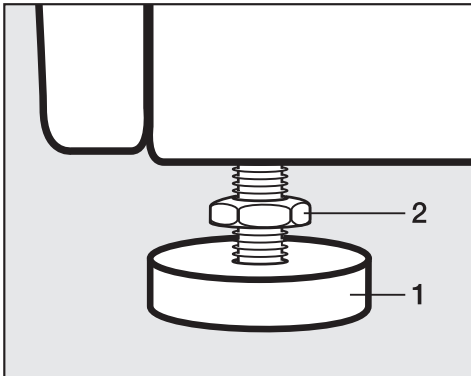

- Using the spanner supplied, turn counter nut **2** in a clockwise direction. Then turn counter nut **2** together with foot **1** to unscrew.

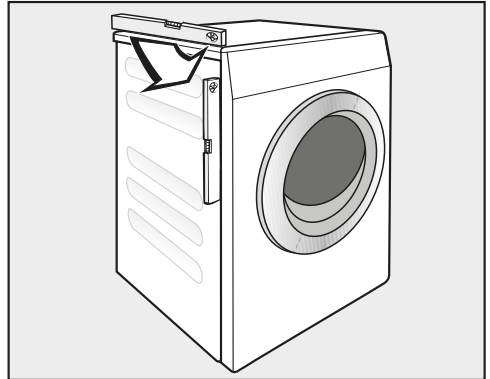

- Use a spirit level to check that the washing machine is standing level.
- Hold foot **1** securely with a pipe wrench. Turn counter nut **2** again using the spanner supplied until it sits firmly up against the housing.

 Risk of damage due to incorrectly aligned washing machine. There is a danger of the washing machine moving about if the feet are not secured.

Turn all four counter nuts for the feet until they sit firmly up against the housing. Please also check this for the feet which did not need adjustment.

Installation

Fixing bracket for plinth

The fixing bracket prevents the washing machine from falling off a plinth during operation.

Fastening with the fixing bracket is only intended for plinths made from concrete. The plinth must be flat and level. The surface below the plinth must be able to withstand the physical loads. Prior to installation, ensure the plinth complies with the minimum dimensions.

Height: 6 cm

Width: 60 cm

Depth: 65 cm

Positioning the fixing bracket

 Risk of injury from sharp edges!

The fixing bracket has sharp edges. You could cut yourself on the edges. Take care when handling the fixing bracket.

Wear gloves while installing the fixing bracket.

The front appliance feet must protrude by at least 3 mm from the bottom of the locknut. The washing machine must already be aligned (see “Installation – Aligning the washing machine”).

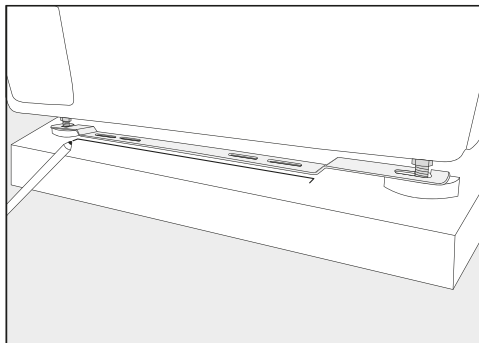

- Place the fixing bracket on the front appliance feet.
- Mark the position of the front edge of the fixing bracket with a pencil.
- Remove the fixing bracket from the feet.
- Carefully move the washing machine until you have enough space to install the fixing bracket.

Installing the fixing bracket

- Place the fixing bracket on the marking on the plinth.
- In the middle of the two outer slotted holes, mark a point for each drill hole.
- Drill 2 holes (8 mm) with a depth of approx. 55 mm.
- Insert the plugs in the holes.

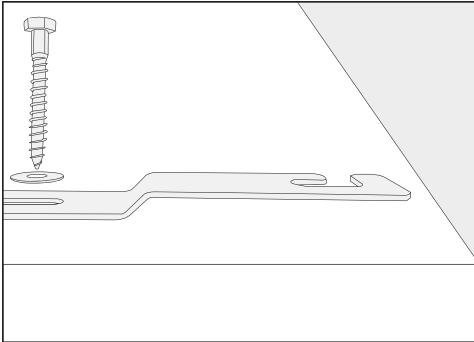

- Install the fixing bracket with the hexagonal screws and the washers.

Do not tighten the screws yet – this will allow the fixing bracket to be moved sideways.

Securing the washing machine with the fixing bracket

- Push the washing machine back on to the installed fixing bracket.

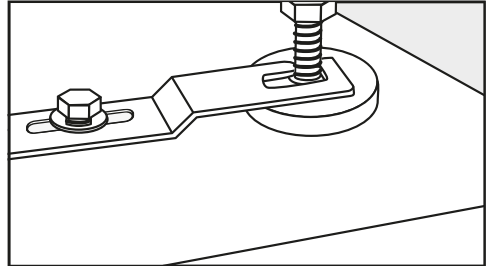

- Insert the appliance feet (the part between the foot and the locknut) into the openings in the fixing bracket.
- Push the fixing bracket to the right as far as it will go.
- Tighten the hexagonal screws using a spanner.

The washing machine is secured in the fixing bracket.

Installation

External control equipment

The XCI box accessory is needed to connect external control equipment, such as payment systems, dispensing systems or peak load control units.

Payment system

This machine can be fitted with a payment system (optional accessory).

The necessary reprogramming must be carried out by Miele.

Coins/tokens must be removed from the coin box regularly. Otherwise, the payment system will become blocked.

Water connection

Cold water connection

The washing machine must be connected to a mains water supply in accordance with current local and national safety regulations.

The flow pressure must amount to a minimum of 100 kPa (1 bar) and must not exceed an overpressure of 1000 kPa (10 bar). If it is higher than 1000 kPa, a pressure reduction valve must be installed.

Connection to the mains water supply should incorporate a water tap with a $\frac{3}{4}$ " threaded union. If this is not available, only a qualified plumber may connect the washing machine to the mains water supply.

The connection point is subject to mains water pressure. Turn on the tap slowly and check for leaks. Correct the position of the washer and union if necessary.

The inlet hose for cold water is not intended to be used for a hot water connection.

Switching to cold water operation

If the washing machine is not connected to a hot water tap, you will have to configure the settings *Main wash water*, *Pre-wash water* and *Rinse water* to cold (see "Supervisor level").

- Unscrew the hot water hose.
- Screw on the stopper provided.

Maintenance

Only use a genuine Miele hose should you ever need a replacement.

A filter is located in the open end of the inlet hose and another in the intake point to protect the inlet valve. Neither filter may be removed.

Hose extension

Longer hoses with a length of 2.5 m or 4.0 m are available from Miele as optional accessories (depending on country).

Installation

Hot water connection*

The hot water temperature must not exceed 70°C.

To minimise energy consumption during operation with hot water, the washing machine should be connected to a suitable hot water ring circuit. So-called “transmission pipes” (single pipes to hot water generators) can result in cooling down of the water remaining in the pipes if not in constant use. More energy would then be consumed to heat the suds up again.

The same connection requirements as for cold water also apply to hot water.

The inlet hose (hot = red stripes) is connected to the water tap.

It is not possible to connect the washing machine to a hot water connection only.

* Some machine versions do not come with a hot water hose.

Switching to hot water operation

If the washing machine is to be connected to hot water, you will have to configure the settings *Main wash water*, *Pre-wash water* and *Rinse water* to warm (see “Supervisor level”).

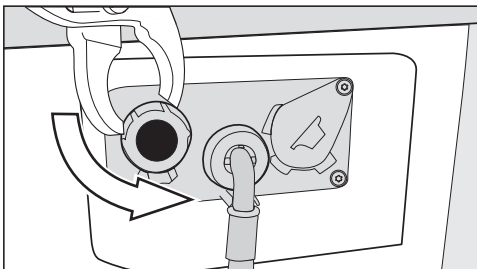

- Unscrew the stopper from the hot water valve.

- Screw on the hot water hose.

IMPORTANT Australia and New Zealand

This appliance must be connected to the water supply in strict accordance with local and national requirements (e.g. Plumbing Code of Australia (PCA)).

This appliance must be installed according to AS/NZS 3500.1 and AS/NZS 3500.2. This washing machine has been supplied with a separate backflow prevention device.

- Disconnect mains power (switch off or unplug the plug).
- Turn off the water tap.
- Place the seals on both sides of the non-return valve.
- Connect the female end of the non-return valve to the water tap.
- Connect the hose to the male end of the non-return valve.
- Turn on the tap gradually to test for leaks.

If there is a leak, the connection might not be on securely, or it may have been screwed on at an angle. Unscrew and reconnect the water correctly before tightening it.

Drainage

Drain valve

The washing machine is drained using a motorised drain valve. A DN 70 angle connector can be used for draining the machine via an on-site floor drain (gully with odour trap).

Electrical connection

This description applies to washing machines both with and without a mains plug.

The following applies to washing machines with a mains plug:

- The washing machine is ready to be connected.
- The electrical socket must be easily accessible after installation so that the machine can be disconnected from the electricity supply if necessary.

 Damage caused by incorrect supply voltage.

The data plate indicates the nominal power consumption and the appropriate fuse rating.

Compare the specifications on the data plate with those of the mains electricity supply.

The washing machine may only be connected to a permanent electrical system that conforms to the national and local codes and regulations.

Do not connect the machine to an extension lead or multi-socket adapter as they do not guarantee the required safety of the appliance (e.g. danger of overheating).

If the appliance is hard wired, a dual circuit breaker must be provided on site. When switched off, there must be an all-pole contact gap of at least 3 mm in the isolator switch (including circuit breakers, fuses, and relays according to

AS/NZS 3000). This connection must be carried out by a qualified and competent electrician.

The plug connector or isolator switch should be easily accessible at all times.

 Risk of electric shock!

If the washing machine is disconnected from the power supply, protective measures must be taken to ensure that the point of disconnection cannot accidentally be switched on again.

Make sure the isolator is lockable or the point of disconnection is monitored at all times.

New connections, modifications to the system, or servicing of the protective earthing conductor, including determining the correct fuse rating, must be carried out by a qualified and competent electrician, as they are familiar with the pertinent regulations and the specific requirements of the electric utility company.

If converting the washing machine to an alternative voltage, ensure that the connection data on the data plate (voltage, frequency and fuse rating) match the mains electrical supply. Observe the instructions in the wiring diagram. Conversion may only be performed by Miele or a Miele authorised service technician.

Technical data

| | |
|--|-----------------------------------|
| Height | 850 mm |
| Width | 596 mm |
| Width (machines with a stainless steel lid) | 605 mm |
| Depth | 714 mm |
| Depth with door open | 1,132 mm |
| Weight | Approx. 100 kg |
| Maximum floor load in operation | 3,000 Newton |
| Capacity | 8.0 kg dry laundry |
| Supply voltage | See data plate on back of machine |
| Rated load | See data plate on back of machine |
| Fuse rating | See data plate on back of machine |
| A-rated sound emissions L_{pA} in accordance with EN ISO 11204/11203 | < 70 dB re 20 μ Pa |
| Minimum water flow pressure | 100 kPa (1 bar) |
| Maximum water flow pressure | 1,000 kPa (10 bar) |
| Intake hose length | 1.55 m |
| Power cord length | 1.80 m |
| Product safety standard | AS/NZS 60335 |
| Test certificates awarded | See data plate |
| Frequency band of the Wi-Fi module | 2.4000 GHz – 2.4835 GHz |
| Maximum transmission power of the Wi-Fi module | < 100 mW |

The complete text of the EU declaration of conformity is available from one of the following internet addresses:

- Under Products at www.miele.com.au
- For service, information, operating instructions etc. go to <https://www.miele.com.au/domestic/customer-information-385.htm> and enter the name of the product or the serial number.

Supervisor level

The settings menu in the  Supervisor level is locked against unauthorised access. The menu can be unlocked with a code.

Code-based access

The Supervisor level is accessed using a code.

The code is **000** (factory default).



Changing the code

You can change the Supervisor level access code to protect the washing machine from unauthorised access.

Please inform Miele if you have forgotten your new code. Miele will have to reset the code.

Make a note of your new code and store it in a safe place.

Opening the Supervisor level

- Turn the programme selector, e.g. to the *Mops 60°C* programme.
- Touch the *Further selections*  sensor.
- Touch the *Supervisor level*  sensor control.

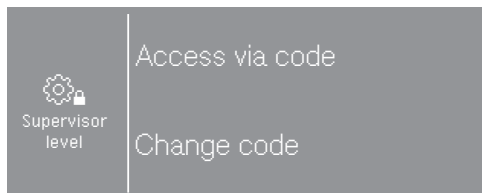

- Select **Access via code**.

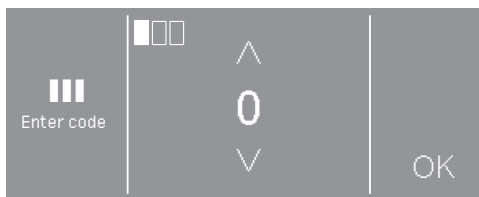

- Enter the individual numbers and confirm each selection with OK.

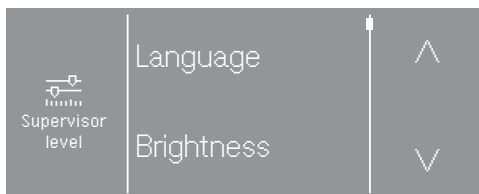

- Select the desired setting.

Some settings are only visible if external devices are connected via the XCI box.

Exiting the Supervisor level

- Touch the  sensor or switch off the washing machine.

Language

The display can be set to appear in one of several different languages. You can select the permanent operator language via the Language submenu.

When a programme is running, you can change the user language using the  sensor control.

Brightness

The brightness of the display can be set in intervals of ten from 10% to 100%.

Factory setting: 70%

Clock display

After selecting the clock format, you can set the time of day.

Clock format

- 24 h clock (factory setting)
- 12 h clock
- Clock off

Set

- The time can be set.

Finish tone volume

The volume for the signal tone that sounds at the end of the programme can be changed.

The tones can be set to one of 7 different levels or switched off altogether.

Factory setting: Off

Keypad tone

The volume of the tone that sounds when a sensor is touched can also be changed.

The tones can be set to one of 7 different levels or switched off altogether.

Factory setting: Normal

Welcome tone volume

The volume of the welcome tone that sounds when the washing machine is switched on can be changed.

The tones can be set to one of 7 different levels or switched off altogether.

Factory setting: Normal

Fault alarm

The signal tone that sounds in the event of a fault can be switched on or off.

Factory setting: Off

Memory

The washing machine will save the latest settings (temperature, spin speed and some of the options) which have been selected for a programme after the programme has started.

When the programme is selected again, the saved settings will appear in the display.

Factory setting: Off

Supervisor level

Anti-crease

The anti-crease function helps prevent creasing if laundry is not going to be removed immediately after the end of the programme.

The drum continues to turn at intervals for up to 30 minutes after the end of the programme. The door can be opened at any time during the anti-crease phase.

Factory setting: On

Suds cooling

Additional water flows into the drum at the end of the main wash to cool the suds down.

Suds cooling takes place when a programme with a temperature of 70°C or higher is selected.

Suds cooling should be activated:

- to prevent the danger of scalding if the drain hose is hooked over the edge of a sink or basin.
- where the drainage pipe is rated less than 70°C.

Factory setting: On

"Display" switch-off status

To save energy, the display goes out and the *Start/Stop* sensor flashes slowly.

Changing this setting leads to increased energy consumption.

- Off
The display will remain on.
- On after 10 min, not in current programme (factory setting)
The display will remain on while the programme is running but will go out 10 minutes after the end of the programme.
- On after 30 min, not in current programme
The display will remain on while the programme is running but will go out 30 minutes after the end of the programme.
- On after 10 min
The display will go out after 10 minutes.
- On after 30 min
The display will go out after 30 minutes.

"Machine" switch-off status

The washing machine switches itself off automatically. It is switched off after the end of the programme/anti-crease phase, or after being switched on if no further selection is made.

Changing this setting leads to increased energy consumption.

- not switching off
- switching off after 15 minutes
- switching off after 20 minutes
- switching off after 30 minutes (factory setting)

Delay start

The type of time input for the Delay start function can be changed or switched off.

- Off
The Delay start function is not available for selection.
- End of programme (factory setting)
With the Delay start function, you specify at what time the wash programme should finish.
- Start of programme
With the Delay start function, you specify at what time the wash programme should start.
- Time until start
With the Delay start function, you specify after how many hours a programme should start.

Programme name

When selecting a standard programme, the name of the selected programme is shown in the display.

- On (factory setting)
When a programme is selected, the programme name is displayed for a few seconds before the display shows the main menu.
- Off
The main menu is displayed immediately.

Visibility parameters

Various parameters are offered/ displayed when a programme is selected. You can decide which parameters should not be displayed. These parameters can then not be edited during programme selection.

Factory default: all parameters are visible.

Pre-wash water

You can select the type of water for the pre-wash.

- Cold
Only cold water is used for the pre-wash.
- Hot
Hot water is also added for the pre-wash.
Hot water can only be added if the wash temperature is above 30°C.

Supervisor level

Main wash water

You can select the type of water for the main wash.

- Cold
Only cold water is used for the main wash.
- Hot
Hot water is also added for the main wash.
Hot water can only be added if the wash temperature is above 30°C.

If the washing machine is not connected to hot water, programme durations will be longer and may deviate from the remaining runtimes displayed.

First rinse water

You can select the water type for the first rinse in some programmes.

- Cold (factory setting)
Only cold water is used for the first rinse.
- Hot
Hot water is also added for the first rinse.

Final rinse water

You can select the water type for the final rinse in some programmes.

- Cold (factory setting)
Only cold water is used for the final rinse.
- Hot
Hot water is also added for the final rinse (only possible for programmes with a temperature of at least 60°C).

Low water pressure

If the water pressure is below 100 kPa (1 bar), the programme will be cancelled and the fault message **Check water inlet will appear**.

If the on-site water pressure cannot be increased, activating the **Low water pressure** setting will prevent the programme from being cancelled.

Factory setting: Off

Pre-spin mops

In the standard mop programmes, wet mops are spun briefly at the start of the programme to remove surplus water.

Factory setting: On

Mops temp. Std plus

The pre-set temperature can be altered in the *Mops plus* and *Mops plus + rtu* programmes.

- 40°C (factory setting)
- 60°C
- 70°C
- 90°C

Mops Ch.-th. dis.

The pre-set disinfection process can be altered in the *Mops chemo-thermal disinfection* programme.

- 40°C/20 min
- 60°C/20 min (factory setting)
- 70°C/10 min

Mops Th.-disin.

The pre-set disinfection process can be altered in the *Mops thermal disinfection* programme.

- 75°C/10 min
- 85°C/15 min (factory setting)

Microfibre mops

The *Microfibre Extra* can be selected for the mop programmes.

- inactive, not visible
- can be selected, visible (factory setting)
- active, not visible

Mops, pre-treat rpm

The pre-set spin speed can be altered in the Pre-treat mops programmes.

- 300 rpm
- 400 rpm
- 600 rpm
- 800 rpm (factory setting)

Cl. cloths temp. Standard plus

The pre-set temperature can be altered in the *Cloths plus* and *Cloths plus + rtu* programmes.

- 40°C
- 60°C (factory setting)
- 70°C
- 90°C

Supervisor level

Clean. cloths Ch.-th. dis.

The pre-set disinfection process can be altered in the *Cloths chemo-thermal disinfection* programme.

- 40°C/20 min
- 60°C/20 min (factory setting)
- 70°C/10 min

Pre-treat cl. cloths rpm

The pre-set spin speed can be altered in Pre-treat cloths programmes.

- 400 rpm
- 600 rpm
- 800 rpm (factory setting)
- 1000 rpm

Empty sensor

A suction lance contact can be used to detect whether external liquid detergent containers are empty. A message will appear if a container is empty.

- Off (factory setting)
The empty container sensing function is switched off.
- Normally open contact
The siphons are equipped with a normally open contact.
- Normally closed contact
The siphons are equipped with a normally closed contact.

Early warning counter

An internal counter reports when an external dispenser container is almost empty. The counter in question then has to be reset.

Water level Cottons

In the *Cottons* programme, you can increase the water level for the main wash.

- + 0 mmWS (factory setting)
- + 10 mmWS
- + 20 mmWS
- + 30 mmWS

Water level Minimum iron

In the *Minimum iron* programme, you can increase the water level for the main wash.

- + 0 mmWS (factory setting)
- + 10 mmWS
- + 20 mmWS
- + 30 mmWS

Pre-wash temp. Cottons

In the *Cottons* programme, you can select the temperature for the pre-wash.

- 30°C (factory setting)
- 35°C
- 40°C
- 45°C

Wash time pre-wash

In the *Cottons* programme, you can extend the duration of the pre-wash.

- + 0 min (factory setting)
- + 6 min
- + 9 min
- + 12 min

Wash time Cottons

In the *Cottons* programme, you can extend the duration of the main wash.

- + 0 min (factory setting)
- + 10 min
- + 20 min
- + 30 min
- + 40 min

Wash time Minimum iron

In the *Minimum iron* programme, you can extend the duration of the main wash.

- + 0 min (factory setting)
- + 5 min
- + 10 min
- + 15 min
- + 20 min

Pre-rinse Cottons

In the *Cottons* programme, a pre-rinse can be activated.

Factory setting: Off

Pre-rinse Minimum iron

In the *Minimum iron* programme, a pre-rinse can be activated.

Factory setting: Off

Pre-wash Cottons/Min. iron

In the *Cottons* and *Minimum iron* programmes, you can choose whether a pre-wash is permanently activated or whether it can be selected during programme selection.

Factory setting: Menu selection

Supervisor level

Cottons rinses

You can alter the number of rinses carried out in the *Cottons* and the standard mop programmes.

- 2 rinse cycles (factory setting)
- 3 rinse cycles
- 4 rinse cycles
- 5 rinse cycles

Minimum iron rinses

In the *Minimum iron* programme, you can change the number of rinse cycles that are carried out.

- 2 rinse cycles (factory setting)
- 3 rinse cycles
- 4 rinse cycles

Disinfection rinse

Additional rinse cycles can be activated in disinfection programmes with a temperature of at least 60°C.

Rinsing is carried out with hot water. The programme duration is extended.

The laundry may feel hot at the end of the programme.
Take care when removing items.

Factory setting: Off

Programme packages

The selection of programmes can be extended by activating single programmes from the programme packages.

The programmes selected from the programme packages are displayed under *Further programmes* .

- Standard
- Pre-treat mops
- Pre-treat cloths
- Ready to use
- Workwear
- Standard programmes

After selecting the programme packages, the individual programmes from the list are activated (activated programmes are marked with a frame). The selection must then be confirmed.

Disinfection prog. code

A code needs to be entered to cancel a disinfection programme. The code can be changed.

The code is: 0 0 0

Useful tip: Make a note of your new code if you ever change it.

Temperature reduction

The suds temperature can be reduced to prevent the suds from boiling too early in high-altitude locations.

Factory setting: Off

Automatic dispensing

Automatic dispensing via an external dispensing system can be activated.

Factory setting: Off

Adjustment value dosage 1–6

To address the tolerances that occur in the pump system over time, the dosage amount (ml/min) for the pumps can be corrected.

The calibration value can be reduced in 3 increments or increased in 3 increments.

The calibration value is increased or reduced by 1, 2 or 3 times the adjustment value based on the selected incremental setting.

The calibration value and the adjustment value must be added to the data for the dispenser pumps by Miele Customer Service.

COM module selection

Your washing machine is equipped with an integrated Wi-Fi module. However, the machine can also be fitted with an external module.

- Off (factory setting)

- Internal module

The internal Wi-Fi module is used.

- External module

An XKM module or RS232 module is inserted into the module slot.

Supervisor level

Availability of Miele digital products

The ability of Miele digital products depends on the availability of the services in your country.

The different services are not available in all countries.

For information about availability, please visit www.miele.com.

Wi-Fi/LAN

Control the networking of your washing machine.

- Setup

This message only appears if the washing machine has not yet been connected to a Wi-Fi network.

- Deactivate (visible when the network is activated)

The network remains set up, the Wi-Fi function is switched off.

- Activate (visible if the network is deactivated)

The Wi-Fi function is reactivated.

- Connection status (visible when the network is activated)

– the quality of the Wi-Fi reception

– the network name

– the IP address

- New setup (visible if set up)

Resets the Wi-Fi login (network) to immediately re-establish a new connection.

- Reset (visible if set up)

The network is no longer set up. To use the network again, a new connection must be established.

– The Wi-Fi is switched off.

– The Wi-Fi connection will be reset to the factory default setting.

Wi-Fi setup

There are 2 possible connection methods.

WPS

- Activate the WPS function on your router within 2 minutes.

Useful tip: If the connection has not been set up when the timeout has finished counting down, repeat the process.

Soft AP

- Activate the function with the Miele App on your smart device within 10 minutes.

Useful tip: The App will guide you through the remaining steps.

Network time

The date and time can be synchronised via the network.

- Off

The date and time are not synchronised via the network.

- as a master

The machines are in a network but are not connected to the internet. One machine is declared as the master and sends data to the *slave* devices.

- as a slave

The machines are in a network with internet connection. All machines are configured as *slaves*. Data is synchronised over the Internet.

External programme lock

The control unit has an option to block programmes. Programmes are blocked by an external system via the COM interface.

Factory setting: Off

Peak load signal

The peak-load cut-off function enables the washing machine to be connected to an energy management system. When a signal is registered, the washing machine's heater is switched off for a short period. The washing machine may only be operated with a peak-load system if this system is connected to the washing machine via the Miele XCI box.

- No function (factory setting)
- Peak load with 230V
- Peak load with 0V

Peak load prevention

The peak-load cut-off function can be deactivated for disinfection programmes. When a signal is registered, the washing machine's heater is not switched off.

Factory setting: Off

Supervisor level

Remote

Operating data relating to the washing machine (e.g. fault messages or notifications) is communicated externally.

Factory setting: On

RemoteUpdate

The RemoteUpdate function is used for updating the software in your washing machine.

RemoteUpdate is activated at the factory.

If you do not install a RemoteUpdate, you can continue to use your washing machine in the usual way. However, Miele recommends installing RemoteUpdates.

Running a RemoteUpdate

If a RemoteUpdate is available for your washing machine, it will be displayed automatically in the open Supervisor level.

You can choose to start the RemoteUpdate immediately or wait until later. If you select "Start later", the prompt to run the RemoteUpdate will be displayed again the next time you switch on your washing machine.

The RemoteUpdate can take several minutes.

Please note the following information about the RemoteUpdate function:

- You will only receive a message when a RemoteUpdate is available.

- Once a RemoteUpdate has been installed, it cannot be undone.
- Do not switch off the washing machine during a RemoteUpdate. Otherwise, the RemoteUpdate will be aborted and will not be installed.

SmartGrid (only functional in selected countries)

You can use the SmartGrid setting to integrate your washing machine into building energy management systems.

Factory setting: Off

Alternating current

The time remaining displayed depends on the electrical connection. If a single-phase connection is used, the setting must be switched to *No*.

Factory setting: Yes

Heater

The heater can be switched off and the Thermostop step is skipped. In addition, heater fault monitoring is deactivated.

Factory setting: On

Legal information

[Open source licences](#)

You can view information at this point.

Copyright and licences for operating and control software

For the purpose of operating and controlling the machine, Miele uses proprietary or third-party software that is not covered by open source licensing terms. These items of software/software components are protected by copyright. The copyright powers of Miele and third parties must be respected.

In addition, the machine contains software components which are distributed under open source licensing terms. You can access these open source components along with the associated copyright notices, copies of the valid licensing terms and any further information in the machine under the menu option [Settings | Machine parameters | Legal information | Open source licences](#). The liability and warranty arrangements for the open source licences displayed at this location only apply in relation to the respective rights holders.

Payment system

The XCI-AD or XCI box accessory unit is required to connect a payment system.

If you wish to change the settings later, please contact Miele.

Settings for payment systems

You would like to connect a payment system.

- No payment system
The next settings are skipped and initial commissioning can be completed.
- Programme operation
The machine is operated using a coin box. The user purchases a wash programme.
- Time operation
The machine is operated using a payment system. The user purchases a time-controlled programme.
- COM module
The machine is operated by a central control unit.

Supervisor level

Feedback signal to pay system

Setting the feedback signal for the payment system.

- Factory setting: Off
- Programme end

The feedback signal is sent at the end of the programme.

- Release of the start button

The feedback signal is sent when the start button is released.

- Start and end of programme

The feedback signal is sent at the start and end of the programme.

- Running programme

The feedback signal is sent continuously from the start until the end of the programme.

Payment system lock

To avoid tampering, a programme lock can be set up in programme operation. If the lock is applied, the programme is interrupted and payment credit is lost as soon as the door is opened.

To offer the possibility to add laundry, the time when the lock activates can be adjusted.

- Off
- As soon as the programme starts
- 1 minute after the start of the programme
- 2 minutes after the start of the programme
- 3 minutes after the start of the programme (factory setting)
- 4 minutes after the start of the programme
- 5 minutes after the start of the programme

FOC programmes

In payment system mode, you can decide whether the Drain/Spin programme can be used for free.

Factory setting: Off

Clear paid signal

The “Paid” signal in payment system mode can be applied until the end of the programme or discarded if the programme has not been started after 5 minutes.

Factory setting: Off

Debounce time

In coin mode, the debounce time for the minimum payment signal that must be applied can be adjusted.

- Factory default: Short

For payment systems where the falling coin generates the paid pulse.

- Long

For central control units on a 230 V basis.

Miele Australia Pty. Ltd.

ACN 005 635 398

ABN 96 005 635 398

Melbourne:

Level 4, 141 Camberwell Road

Hawthorn East, VIC 3123

Telephone: 1300 731 411

service.prof@miele.com.au

**www.miele.com.au/professional
sales@miele-professional.com.au**

Miele New Zealand Limited

IRD 98 463 631

8 College Hill

Freemans Bay

Auckland 1011

New Zealand

Telephone: 0800 4 MIELE

(0800 464 353)

www.miele.com.au/professional
sales@miele-professional.com.au



Miele Global Headquarters: Miele & Cie. KG
Carl-Miele-Straße 29, 33332 Gütersloh, Germany

PWM 508 Mop Star 80

en-AU, NZ

M.-Nr. 12 131 740 / 00