

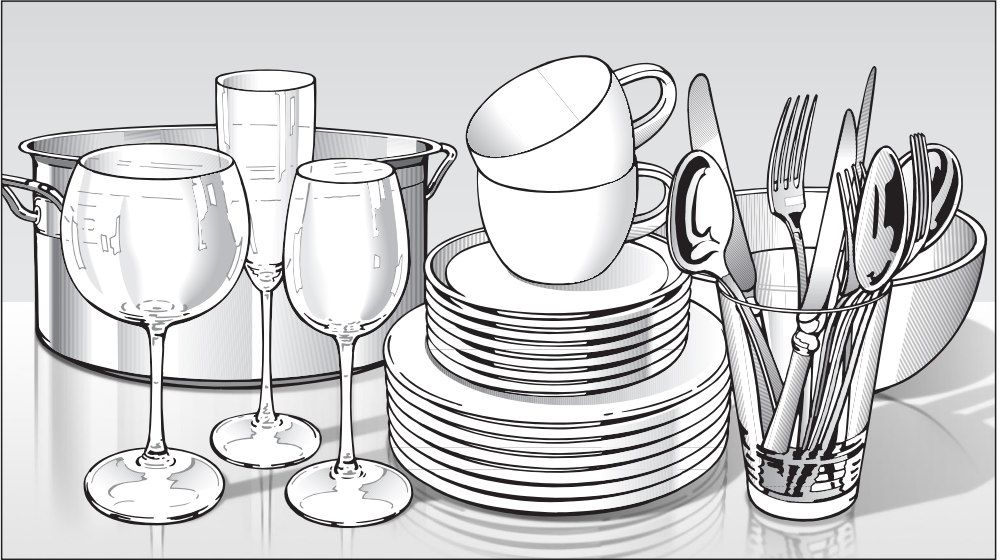

**Miele**

# Operating instructions



## Commercial Dishwasher PFD 101 / PFD 101i / PFD 103 SCi

en-AU, NZ

 It is **essential** to read these operating instructions before installing and using the appliance. This will prevent both personal injury and damage to the machine.

M.-Nr. 11 678 870

# Contents

---

<b>Notes about these instructions</b> .....	5
Operating steps.....	5
<b>Guide to the appliance</b> .....	6
Appliance overview.....	6
Control panel.....	7
Display functions.....	8
<b>Correct application</b> .....	9
<b>Warning and Safety instructions</b> .....	11
<b>Caring for the environment</b> .....	19
<b>Commissioning</b> .....	20
Basic settings.....	20
Setting the language.....	20
Setting up Miele@home.....	20
Setting the time of day.....	21
Setting the water hardness.....	21
Miele@home.....	22
Opening the door.....	24
Close the door.....	25
Activating the safety lock.....	25
Reactivation salt.....	26
Filling the salt reservoir.....	27
Replenishing salt.....	27
Rinse aid.....	28
Adding rinse aid.....	29
Refilling rinse aid.....	29
<b>Caring for the environment</b> .....	30
Economical dishwashing.....	30
EcoFeedback consumption display.....	31
<b>Loading the dishwasher</b> .....	32
General information.....	32
Upper basket.....	34
Adjusting the upper basket.....	37
Lower basket.....	38
Cutlery tray.....	41
Loading the 3D MultiFlex tray.....	41
Loading examples.....	42
Dishwashers with cutlery tray.....	42

<b>Comparison tests</b> .....	44
XXL height with cutlery tray.....	47
<b>Detergent</b> .....	50
Application .....	50
Detergent dispensing .....	51
Adding detergent.....	52
Changing detergent.....	54
<b>Operation</b> .....	55
Switching on the dishwasher .....	55
Selecting a programme .....	55
Display of programme duration .....	56
Starting a programme .....	56
At the end of the programme .....	57
Energy management .....	57
Switching off the dishwasher .....	58
Unloading the dishwasher.....	58
Interrupting a programme.....	59
Cancelling or changing a programme .....	59
<b>Programme options</b> .....	60
Options .....	60
⌚ Timer .....	61
Activating Remote start  .....	65
<b>Programme chart</b> .....	66
<b>Cleaning and care</b> .....	71
Maintenance.....	71
Cleaning the wash cabinet.....	71
Cleaning the door and the door seal.....	72
Cleaning the control panel .....	72
Cleaning the appliance front .....	72
Cleaning the spray arms.....	73
Checking the filters in the wash cabinet .....	75
Cleaning the filters.....	75
Cleaning the water inlet filter.....	77
Cleaning the drain pump.....	78
<b>Problem solving guide</b> .....	80
Technical problems .....	80
Fault messages .....	81
Door release .....	82

# Contents

---

Water intake fault.....	83
Water drainage fault .....	84
General problems with the dishwasher .....	85
Noises.....	86
Unsatisfactory washing result .....	87
<b>After sales service</b> .....	90
Contact in case of fault .....	90
Programme updates .....	90
Warranty .....	90
<b>Installation</b> .....	91
Electrical connection .....	91
The Miele Waterproof system.....	92
Water intake .....	92
Connecting the drain hose .....	94
<b>Technical data</b> .....	95
<b>Settings</b> ▾ .....	96
Opening the Settings menu.....	96
Changing settings .....	96
Language ▾ .....	97
Time of day.....	97
Water hardness .....	98
Rinse aid.....	99
External dispensing .....	99
Temperature unit.....	100
High temperature final rinse .....	100
Miele@home .....	101
Remote control .....	103
RemoteUpdate .....	104
SmartStart .....	105
EcoStart.....	105
Consumption (EcoFeedback) .....	107
Display brightness .....	108
Volume.....	108
Refill reminders.....	109
AutoOpen .....	109
BrilliantLight.....	110
Software version.....	110
Showroom .....	110
Factory default.....	110

# Notes about these instructions

---

## Warnings

 Information which is important for safety is highlighted in a thick framed box with a warning symbol. This alerts you to the potential danger of injury to people or damage to property.

Read these warning notes carefully and observe the procedural instructions and codes of practice they describe.

## Notes

Notes contain information of particular importance that must be observed. They are highlighted by a thick framed box.

## Additional information and comments

Additional information and comments are highlighted in a box framed with a thin black line.

## Operating steps

Instructions on how to operate the commercial dishwasher are identified by marked operating steps. They explain the procedure step by step. Each step is indicated by a black square bullet point.

Example:

- Select the desired setting and press *OK* to confirm.

## Display

Information given via the commercial dishwasher display appears in a special display font to match the font on the machine.

Example:

When the message  Finished or AutoOpen appears in the display ...

# Guide to the appliance

## Appliance overview

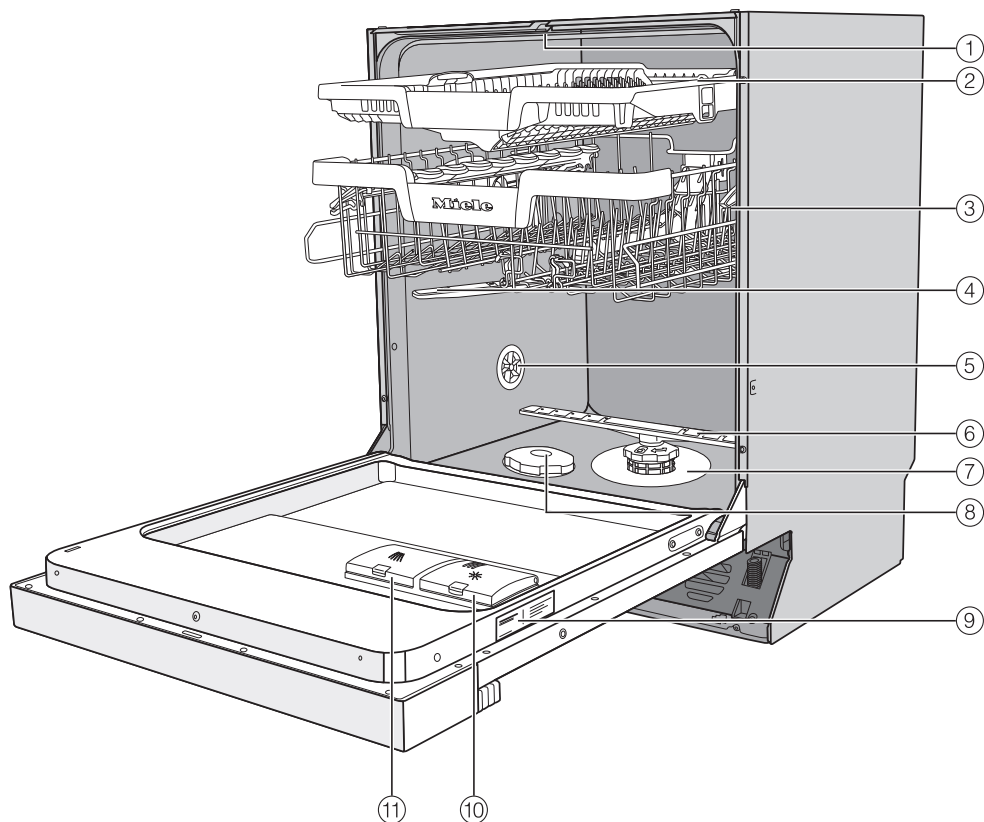

- ① Top spray arm
- ② 3D MultiFlex tray (depending on model)
- ③ Upper basket (depending on model)
- ④ Middle spray arm
- ⑤ Ventilation
- ⑥ Lower spray arm
- ⑦ Filter combination
- ⑧ Salt reservoir
- ⑨ Data plate
- ⑩ Rinse aid reservoir
- ⑪ Detergent compartment

## Control panel

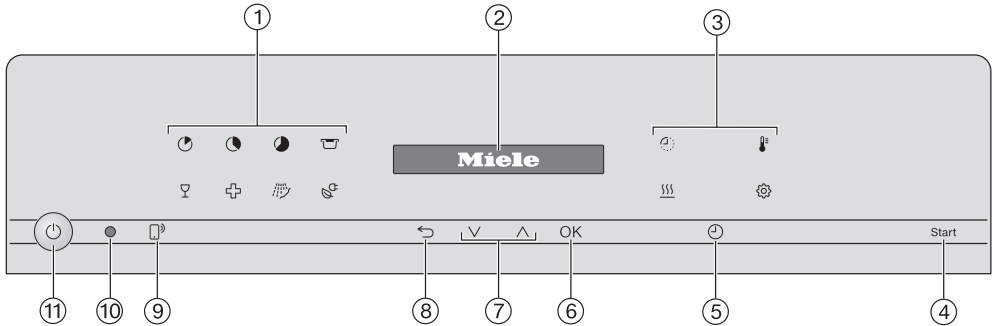

### ① Programme selection

- ☐ = Short
- ◐ = Medium
- ◑ = Intensive
- ☒ = Plastics
- ☒ = Glasses
- ⊕ = Hygiene
- ☒ = Cold pre-wash
- ☒ = ECO

### ② Display

For further information, see “Guide to the appliance - Display functions”.

### ③ Options

- 🕒 = Time left
- 🌡️ = Temperature
- 🌀 = Additional drying
- ⚙️ = Settings

### ④ Start sensor

For starting the selected programme.

### ⑤ ⌚ Timer sensor

For selecting a later programme start.

### ⑥ OK sensor

For selecting menu options and values displayed.  
For confirming messages.

### ⑦ ∨∧ sensors

For programme selection.  
For changing the values displayed.  
For scrolling to other menu pages.

### ⑧ ↶ Back sensor

For navigating back to the previous menu or deleting values which have been set previously.

### ⑨ 📶 Remote control sensor

For activating/deactivating the Remote start option.

### ⑩ 🔍 Optical interface

For service technicians.

### ⑪ ⏻ On/Off sensor

For switching the dishwasher on and off.

# Guide to the appliance

---

## Display functions

The display is used to select or set the following:

- the programme
- the timer
- the Settings 



The display can show the following:

- the programme stage
- the estimated time left for the programme to run
- the current temperature of the programme stage
- water consumption
- any relevant fault messages and information

To save energy, the dishwasher switches off after a few minutes if you do not touch any sensors during this time.

Touch the  sensor to switch the dishwasher back on.

The *OK* sensor is used to confirm a message or setting and also to move to the next menu or another level.

Under  *Settings* a scroll bar  will appear in the right of the display. This offers further options. These options can be viewed using the  $\nabla/\wedge$  sensors.

You can alter the dishwasher's controls to suit changing requirements in the Settings menu (see "Settings").

The option that is selected will have a tick  next to it.

To exit a submenu use the  *Back* sensor.

If you do not press any sensors for several seconds, the display will revert to the previous menu. You will then have to enter your settings again.



This commercial dishwasher complies with all current local and national safety requirements. However, inappropriate use can lead to personal injury and damage to property.

Read the operating instructions carefully before using the commercial dishwasher for the first time. They contain important information on the safety, use and maintenance of the machine. You will prevent the risk of accidents and damage to the commercial dishwasher. Keep these operating instructions in a safe place and pass them on to any future user.

▶ This dishwasher with its short programme running times and powerful cleaning performance is intended for commercial use in offices, lunch rooms, clubhouses, workshops, large kitchens and similar professional environments.

It is also suitable for use in domestic households and in similar residential environments; for example, by customers in hotels, motels, bed and breakfasts and other related establishments.

▶ The commercial dishwasher is hereafter called a dishwasher in these operating instructions.

Glasses, cutlery and crockery are referred to generally as crockery when not more specifically defined.

▶ This dishwasher is not suitable for continuous operation.

▶ This dishwasher may not be used to clean medical products or devices.

▶ This machine is designed exclusively for use as a “dishwasher” for cleaning loads as described in these instructions. Conversions, modifications and any other use are not permitted.

▶ This dishwasher is intended for stationary, indoor use only.

▶ The dishwasher is intended for use at altitudes of up to 4000 m above sea level.

## Correct application

---

- ▶ The special inserts in the baskets should only be used for their specific application.
- ▶ This dishwasher can only be used by people with reduced physical, sensory or mental capabilities, or lack of experience or knowledge, if they are supervised whilst using it or have been shown how to use it in a safe way and understand and recognise the consequences of incorrect operation.
- ▶ This dishwasher is supplied with a special lamp (depending on the model) to cope with particular conditions (e.g. temperature, moisture, chemical resistance, abrasion resistance and vibration). This lamp must only be used for the purpose for which it is intended. The lamp is not suitable for room lighting. Replacement lamps may only be fitted by a qualified electrician or a Miele authorised technician.  
The lighting control element is integrated into the appliance controls and cannot be removed separately. As a result, electricity consumption cannot be measured separately.

### Correct installation

▶ Do not install this dishwasher in an area where there is a risk of explosion or freezing conditions.



▶ Be careful when installing the dishwasher. Wear protective gloves to avoid injury on any sharp metal components.

▶ To ensure the stability of built-under dishwashers, they must only be installed beneath a continuous worktop that is bolted to the adjacent cabinetry.

▶ In order to reduce the risk of damage from condensation, the furniture in the area around the dishwasher should be designed for commercial use.

Delicate furniture can be protected by installing the steam protection kit optional accessory. The vapour barrier film needs to be adhered to the underside of the worktop where the dishwasher door is opened.

▶ The door springs must be evenly adjusted on both sides. They are correctly adjusted when the door remains stationary when left half open (approx. 45° opening angle). The door must not fall open on its own beyond this point.

The appliance must only be operated with properly adjusted door springs.

If the door cannot be adjusted properly, contact Miele.

The maximum weight of the front panel that can be aligned with the factory fitted door springs is 10–12 kg (depending on model).

# Warning and Safety instructions

---

## Technical safety

- ▶ This dishwasher must only be installed, commissioned, repaired and maintained by Miele Professional Service or a suitably qualified service technician. Unauthorised installation, maintenance and repairs can pose a considerable risk to the user.
- ▶ In the case of commercial dishwashers, they must only be operated by appropriately trained personnel. They must be instructed and trained regularly.
- ▶ Before using the dishwasher, check it for any externally visible damage. Under no circumstances should you use a damaged appliance. A damaged appliance could be dangerous.
- ▶ In the event of a damaged or leaking dishwasher, switch off at the power supply immediately and call Miele Professional Service.
- ▶ Faulty components must only be replaced by genuine Miele original spare parts. Only when these parts are fitted can Miele guarantee the safety standards of the appliance.
- ▶ The electrical safety of this dishwasher can only be guaranteed when continuity is complete between it and an effective earthing system. If in any doubt, please have the electrical installation tested by a qualified electrician.
- ▶ Please follow the advice on installation in these instructions and the separate Installation diagram.
- ▶ Before connecting the dishwasher, ensure that the connection data on the data plate (voltage, frequency and fuse rating) match the mains electrical supply.

## Warning and Safety instructions

---

▶ The dishwasher may only be operated if the door opening mechanism (depending on model) is working correctly, as otherwise there could be a danger when the automatic door opening is activated.

The maximum weight of the front panel that can be aligned with the factory fitted door springs is 10–12 kg (depending on model).

To check that the door opening mechanism is working correctly:

- The door springs must be evenly adjusted on both sides. They are correctly adjusted when the door remains stationary when left half open (approx. 45° opening angle). The door must not fall open on its own beyond this point.
- The door locking pin retracts automatically after the drying phase when the door is opened.

▶ There must be no electrical sockets behind the dishwasher. There is a danger of overheating and risk of fire if the dishwasher were to be pushed up against a plug. See “Electrical connection”.

▶ Do not connect the dishwasher to the mains electricity supply by a multi-socket unit or an extension lead. These do not guarantee the required safety of the appliance (e.g. danger of overheating).

▶ Never open the casing of the appliance. Tampering with electrical connections or components and mechanical parts is highly dangerous to the user and can cause operational faults.

▶ The dishwasher must not be used if the electrical connection cable is damaged. A damaged connection cable may only be replaced by a suitable connection cable of the same type. For safety reasons, such replacement may only be carried out by Miele Professional Service or a Miele authorised technician.

▶ This dishwasher must be disconnected from the mains electricity supply before any maintenance or repair work is carried out.

▶ The plastic housing of the water connection contains two electrical components. It must not be dipped in water.

## Warning and Safety instructions

---

- ▶ There are electrical wires in the water inlet hose. Do not cut the hose, even if it is too long.
- ▶ The integrated water protection system offers protection from water damage, provided the following conditions are met:
  - Installation has been carried out correctly.
  - The dishwasher is properly maintained and parts are replaced where it can be seen that this is necessary.
  - The taps have been turned off during longer periods of inactivity (e.g. whilst on holiday).

The Waterproof system will work even when the dishwasher is switched off. However, the dishwasher must remain connected to the electricity supply.

- ▶ The manufacturer's warranty will be invalidated if the dishwasher is not repaired by a Miele authorised service technician.
- ▶ In areas which may be subject to infestation by cockroaches or other vermin, pay particular attention to keeping the appliance and its surroundings in a clean condition at all times. Any damage which may be caused by cockroaches or other vermin will not be covered by the warranty.

### Correct use

- ▶ This dishwasher is designed for operation with water and cleaning agents suitable for use in commercial dishwashers only. Organic solvents and flammable liquid agents must not be used in it. This could cause an explosion, damage rubber or plastic components in the dishwasher and cause liquids to leak out of it.
- ▶ Avoid leaving the door open unnecessarily as someone could trip over it and be injured by it.
- ▶ Do not sit, stand or lean on the opened door. The dishwasher may tip or be damaged.
- ▶ After any plumbing work, the water pipework to the dishwasher will need to be vented. If this is not done, components can be damaged.
- ▶ Please be aware that the dishwasher may be operating at high temperatures. When the door is opened there is a danger of burning or scalding. Items, baskets and inserts must be allowed to cool down before they are unloaded. Any water remaining in containers could still be very hot. Empty them into the wash cabinet before taking them out.
- ▶ The water in the wash cabinet must not be used as drinking water.
- ▶ Pre-treating items (for example with washing-up liquid and other cleaning agents) as well as some types of soiling and some cleaning agents can cause a build-up of foam in the wash cabinet. Foam can have an adverse effect on the cleaning result.
- ▶ Foam escaping from the wash cabinet can cause damage to the dishwasher. If foam escapes, the programme must be cancelled immediately and the machine must be disconnected from the mains electrical supply.

## Warning and Safety instructions

---

- ▶ Depending on the properties of the flooring and footwear worn on it, liquids can cause a slipping hazard. As far as possible, please keep the floor dry and remove any liquids immediately using suitable materials. Appropriate protective measures are to be employed when removing hazardous substances and hot liquids.
- ▶ When using cleaning agents and specialised products, it is essential that the manufacturer's instructions are followed. Cleaning agents must only be used for the purpose they are designed for by the manufacturer to avoid any material damage or the occurrence of strong chemical reactions (e.g. oxyhydrogen explosion).
- ▶ Miele cannot be held liable for any effect chemical cleaning agents may have on the material of the items being cleaned. Observe the cleaning agent manufacturer's instructions with regard to storage conditions, use and dosage.
- ▶ Do not inhale or ingest powder cleaning agent. Do not swallow dishwasher cleaning agents. They can cause burning in the nose, mouth and throat. Seek medical attention immediately if cleaning agent has been swallowed or inhaled.
- ▶ Persons 16 years and older may refill cleaning chemicals or change canisters if they have been correctly instructed on how to do so.
- ▶ Powder and liquid detergents containing active chlorine must not be used. You may damage plastic parts and the seals of the dishwasher.
- ▶ To avoid material damage and corrosion, do not allow any acids or solutions containing chloride to get into the wash cabinet or onto the casing. Similarly avoid any ferrous materials with a corrosive effect.
- ▶ Do not wash items soiled with ash, sand, wax, lubricating grease or paint in the dishwasher. These materials will cause damage to the dishwasher.



## Warning and Safety instructions

---

- ▶ Do not hose the dishwasher or near vicinity down to clean it, e.g. with a hose or a pressure washer.
- ▶ Be careful when sorting items with sharp pointed ends and positioning them in the dishwasher that you do not hurt yourself or create a danger for others. Knives and other utensils with sharp points must be loaded with the pointed end facing downwards or placed in a horizontal position.
- ▶ Remove any coarse food deposits and empty out any containers or utensils before loading them in the dishwasher.
- ▶ Some dishwasher detergents are strongly alkaline. They can be extremely dangerous if swallowed. Avoid contact with the skin and eyes and keep children away from the dishwasher when the door is open. Check that the detergent receptacle is empty after completion of the wash cycle.

### **Safety with children**

- ▶ Children should be supervised in the vicinity of the dishwasher. Do not let children play with the dishwasher. There is a danger that children might shut themselves in the dishwasher.
- ▶ Young children must not be allowed to use this appliance.
- ▶ Older children may only operate the dishwasher unsupervised if they have been taught how to operate it safely. Children must be able to understand and recognise the possible dangers caused by incorrect operation.
- ▶ If the automatic door opening mechanism is active, keep young children away from the area in which the door opens. There is a danger of injury in the unlikely event of a fault with the opening mechanism.

## Warning and Safety instructions

---

▶ Keep children away from chemical agents. These contain irritant and corrosive ingredients which can cause burning in the mouth and throat, or inhibit breathing. Keep children away from the dishwasher when the door is open. There could still be residual process chemicals in the cabinet. Seek medical advice immediately if a child has swallowed or inhaled chemical agents.

### Accessories

- ▶ Only use original Miele accessories. Using spare parts or accessories from other manufacturers will invalidate the warranty, and Miele cannot accept liability.
- ▶ Miele will guarantee to supply functional spare parts for a minimum of 10 years and up to 15 years following the discontinuation of your dishwasher.

### Transport

- ▶ Only transport the dishwasher in an upright position so that no water flows into the electrical controls, as this would cause faults.
- ▶ If you wish to transport the dishwasher, empty it and securely fasten all loose parts such as baskets, hoses, and cables.

Miele cannot be held liable for damage caused by non-compliance with these Warning and Safety instructions.

### Disposal of the packing material

The transport and protective packaging has been selected from materials which are environmentally friendly for disposal, and can normally be recycled.

Recycling the packaging reduces the use of raw materials in the manufacturing process and also reduces the amount of waste in landfill sites. Ensure that any plastic wrappings, bags etc. are disposed of safely and kept out of the reach of babies and young children. Danger of suffocation.

### Disposing of your old appliance

Electrical and electronic appliances often contain valuable materials. They also contain specific materials, compounds and components, which were essential for their correct function and safety. These could be hazardous to human health and to the environment if disposed of with your domestic waste or if handled incorrectly. Please do not, therefore, dispose of your old appliance with your household waste.



Please dispose of it at your local community waste collection / recycling centre for electrical and electronic appliances. You are also responsible for deleting any personal data that may be stored on the appliance prior to disposal. Please ensure that your old appliance poses no risk to children while being stored prior to disposal.

# Commissioning

---

## Basic settings

### Switching on the dishwasher

- Switch the dishwasher on using the  sensor.

The welcome screen will appear when the dishwasher is switched on and the welcome melody will sound.

For further information about the display functionality, see “Guide to the appliance - Display functions”.

### Setting the language

The display will change automatically to the screen for setting the language.

- Select the language and the country, if applicable, using the  $\vee/\wedge$  sensors, and confirm with *OK*.

For further information on setting the language, see “Settings - Language”.

A tick  will appear next to the language that has been set.

## Setting up Miele@home

The message Miele@home will appear in the display.

- To set up Miele@home now, confirm by touching *OK*.

**Useful tip:** To postpone set-up until later, select the option *Skip* and confirm with *OK*.

There are two ways of connecting your dishwasher to your Wi-Fi network:

- Select the connection method you want and confirm your selection with *OK*.

1. Connect using App
2. Connect using WPS (WPS = Wi-Fi Protected Setup)

You will then be guided by the display and the Miele network solution.

For further information on Miele@home, see “Settings - Miele@home”.

## Setting the time of day

The time is updated automatically if a connection is established to the Wi-Fi network.

The display will then change to the screen for setting the time.

The current time of day must be set before you can use the timer option.

- Use the  $\vee/\wedge$  sensors to enter the hour and confirm your entry with *OK*.
- Then set the minutes and confirm with *OK*.

Keeping the relevant  $\vee$  or  $\wedge$  sensor pressed will increase or decrease the time automatically.

## Setting the water hardness

The display will change to the screen for setting the water hardness.

- The dishwasher needs to be programmed to the correct water hardness for your area.
- Your local water authority will be able to advise you of the water hardness level in your area.
- Where the water hardness fluctuates, e.g. between 1.8 and 2.7 mmol/l (10 - 15 °dH - German scale), always programme the dishwasher to the higher value (2.7 mmol/l or 15 °dH in this example).

In the event of a fault, it will help the service technician if you know the hardness of your local water supply.

Enter the water hardness below:

\_\_\_\_\_ mmol/l

The dishwasher is programmed at the factory for a water hardness level of 2.5 mmol/l (14 °dH - German scale).



- Set the water hardness level in your area and confirm with *OK*.

See “Settings - Water hardness” for more information.

# Commissioning

---

Finally, prompts will appear in the display.

After confirming these prompts with **OK**, the messages  Refill salt and  Refill rinse aid may appear.

- Add salt and rinse aid if necessary (see “Using for the first time - Dishwasher salt” and “Rinse aid”).
- Select **OK** to confirm the messages.

When a programme is selected, it will appear briefly in the display and the appropriate sensor will be illuminated. Next, the estimated energy and water consumption may be shown for the selected programme for several seconds.

Finally, the display will show the estimated programme duration for the programme selected.

## Miele@home

Your dishwasher is equipped with an integrated Wi-Fi module.

To use this feature, you will need:

- a Wi-Fi network
- a network solution from Miele, e.g. Miele@mobile App
- a Miele user account You can create a user account using the network solutions from Miele, .e.g via the Miele@mobile App.

The relevant network solution will guide you as you connect your dishwasher to your home Wi-Fi network.

Once your dishwasher is connected to your Wi-Fi network, you can use the network solution to carry out the following tasks:

- Call up information on the operating status of your dishwasher
- Call up information on the programme sequence of your dishwasher

Connecting the dishwasher to your Wi-Fi network will increase energy consumption, even when the dishwasher is switched off.

Make sure that your Wi-Fi network signal strength is strong enough at the installation site of your dishwasher.

## Availability of the Wi-Fi connection

The Wi-Fi connection shares a frequency range with other appliances (including microwave ovens and remote control toys). This may result in sporadic or even complete connection failures. Therefore, a constant availability of featured functions cannot be guaranteed.

## Miele@home availability

The ability to use the Miele@mobile App, or other network solutions, depends on the availability of the Miele@home service in your country.

The Miele@home service is not available in every country.

For information about availability, please visit [www.miele.com](http://www.miele.com).

## Miele App

You can connect the dishwasher to the Miele@mobile App. The App is available to download free of charge from the Apple App Store® or from the Google Play Store™.

## Miele@mobile App



# Commissioning

Every dishwasher is tested at the factory. There will be residual water in the machine from this test. It is not an indication that the dishwasher has been used previously.

## Opening the door

In some programmes the door automatically opens slightly to assist the drying process.

This function can be deactivated, if preferred (see “Settings - AutoOpen”).

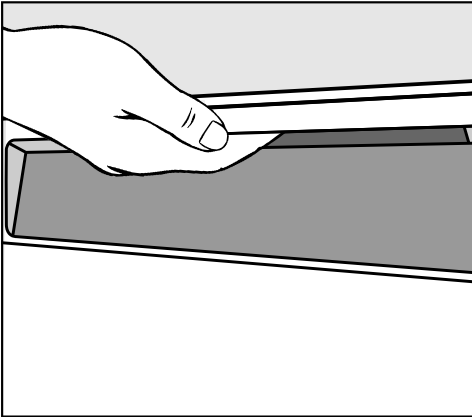

- To open the door, reach under the door grip and pull.
- Open the door fully to disengage the locking mechanism.

At the end of the programme, if the AutoOpen function is on, the door locking pin automatically retract.

To prevent a technical fault, do not hold the door locking pin firmly when it is retracting.

If the door is opened during operation, all functions are automatically interrupted.

 Risk of scalding due to hot water.

During operation, water in the dishwasher may be very hot. Only open the door if absolutely necessary and exercise extreme caution when doing so.

 Risk of injury due to door opening automatically. The door may open automatically at the end of a programme. Keep the area around the door free of obstructions.



## Close the door

- Push the baskets right in.
- Raise the door upwards until the catch engages.

 Risk of crushing due to the door closing.

When closing the door, you are at risk of jamming your fingers in it. Do not put your hand inside the door as it is closing.

## Activating the safety lock

Use the safety lock to prevent children opening the dishwasher door. The door can then only be opened by using a lot of force.

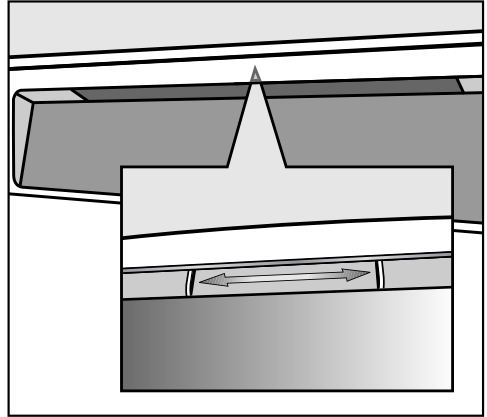

- To lock the door, push the slide underneath the door grip to the right.
- To unlock the door, push the slide to the left.

# Commissioning

## Reactivation salt

In order to achieve good cleaning results, the dishwasher needs to operate with soft water. Hard water results in the build-up of calcium deposits on dishes and on the inner surfaces of the appliance.

Water with a hardness level higher than 0.9 mmol/l (5 °dH – German scale) must be softened. This occurs automatically in the integrated water softener. The water softener is suitable for a water hardness level of up to 6.5 mmol/l (36 °dH - German scale).

In order to maintain the functioning of the water softener, it must be reactivated regularly. Reactivation occurs automatically in every ninth programme sequence. At the start of the next programme, an additional 4.4 l of water is required for this process. Energy consumption increases by 0.015 kWh and the programme is extended by 3 minutes.

The above only applies to the ECO programme at a water hardness of 2.5 mmol/l (14 °dH – German scale). For other programmes and water hardness levels, the frequency of reactivation will differ.

In order to be reactivated, the water softener requires dishwasher salt. Depending on the water hardness level (< 3.8 mmol/l, or < 21 °dH – German scale), dishwasher salt is not required if combination detergents are being used (see “Detergents - Types of detergents”).

 Damage caused by using unsuitable salts.

Some types of salt may contain insoluble components which can cause the water softener to malfunction.

Only use special coarse-grained dishwasher salt or other pure evaporated salts for reactivation.

 Damage to the water softener from detergents.

Dishwasher detergent will damage the water softener.

Do not fill the salt reservoir with powder or liquid detergent.

If the water in your area is very soft and constantly **lower than 0.9 mmol/l (5 °dH - German scale)** you do **not** need to add dishwasher salt. The salt refill indicator will automatically switch off after the water hardness has been set accordingly (see “Settings - Water hardness”).

If you only ever use combination detergent products in your dishwasher, you can switch off both refill reminders if you wish (see “Settings - Refill reminders”).

Please make sure that if you stop using combination detergents, you refill the dishwasher salt and rinse aid. Switch the refill reminders back on if required.

## Filling the salt reservoir

Before filling the salt reservoir for the first time, you must fill it with approx. 2 litres of water to enable the salt to dissolve.

Once the dishwasher has been used, there is always sufficient water in the salt reservoir.

- Remove the lower basket from the wash cabinet and unscrew the salt reservoir cap.
- Fill the salt reservoir with approx. 2 litres of water (first use only).

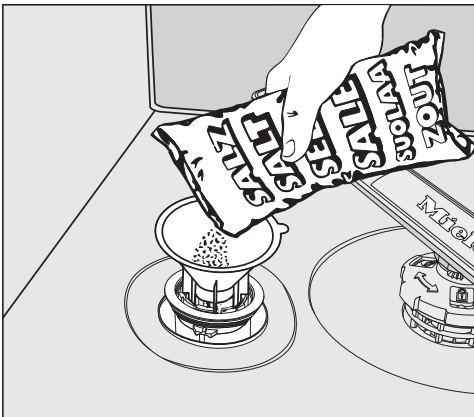

- Place the funnel provided over the salt reservoir and carefully fill with dishwasher salt until the reservoir is full. The salt reservoir holds up to 2 kg of salt, depending on the type of salt used.
- Clean off salt residues from around the salt reservoir opening. Next, screw the salt reservoir cap on again firmly.

## Replenishing salt

- When  Refill salt appears in the display, wait until the end of the programme and then refill the salt reservoir.
- Confirm with *OK*.

The salt refill indicator will go out.

 Risk of corrosion due to saline solution.

Saline solution that runs out can cause corrosion in the wash cabinet and to the dishwasher load.

Each time you have opened the salt reservoir cap, immediately run the  *Cold pre-wash* programme without any dishes. This will dissolve and remove any traces of salt from the wash cabinet.

After the salt reservoir has been filled, the salt refill indicator may still appear in the display if the salt concentration has not yet reached the correct level. In this case, confirm the message again with *OK*.

# Commissioning

---

## Rinse aid

Rinse aid is necessary to ensure water does not cling to and leave marks on crockery during the drying phase, and it helps crockery dry faster after it has been washed.

Rinse aid is poured into the storage reservoir and the amount set is dispensed automatically.

 Washing-up liquid or detergent can cause damage.

Washing-up liquid and dishwasher detergent will damage the rinse aid reservoir.

Only fill it with rinse aid formulated for domestic dishwashers.

Alternatively, you can use liquid citric acid with up to 10% acid content. The dishes will, however, be more moist and stained than with rinse aid.

 Risk of acid damage.

The dishwasher can be damaged by acids with a higher concentration.

Never use citric acid or vinegar with a higher acid content.

If you only ever use combination detergent products in your dishwasher, you do not need to fill the rinse aid reservoir.

However, the best rinsing and drying results will be achieved by using a detergent together with separate dishwasher salt and rinse aid.

If you want to permanently use combination detergent products in your dishwasher, you can switch off the refill reminders for salt and rinse aid if you wish (see “Settings - Refill reminders”).

Please make sure that if you stop using combination detergents, you refill the dishwasher salt and rinse aid. Switch the refill reminders back on if required.

## Adding rinse aid

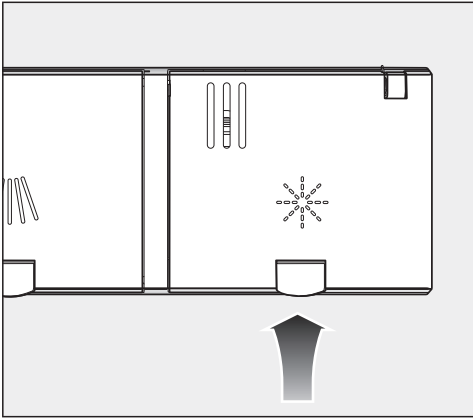

- Lift the yellow button on the lid of the rinse aid container .

The lid will open.

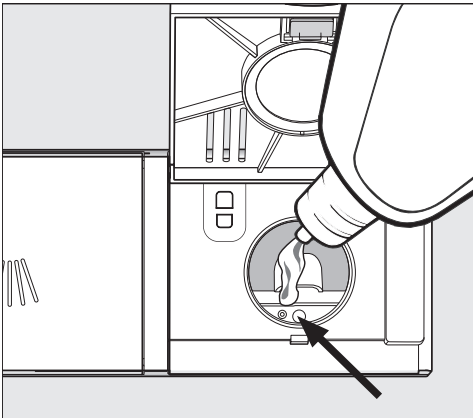

- Only add rinse aid until the fill level indicator (see arrow) turns dark when the door is open horizontally.

The rinse aid reservoir holds approx. 110 ml.

- Close the flap firmly so that it clicks into place. Otherwise water can enter the rinse aid reservoir during a programme.

- Wipe up any spilled rinse aid. This prevents over-foaming occurring during the next programme.

You can adjust the rinse aid dosage for best results (see "Settings - Rinse aid").

## Refilling rinse aid

When the  Refill rinse aid message appears, the reservoir only contains sufficient rinse aid for another 2–3 programmes.

- Add rinse aid in good time.
- Confirm with OK.

The refill rinse aid reminder will go out.

# Caring for the environment

---

## Economical dishwashing

This dishwasher is exceptionally economical in its use of water and electricity.

You can support the economical operation of your appliance by following these tips:

- Washing in a dishwasher generally uses less water and energy than washing dishes by hand.
- Pre-rinsing dishes under running water is not necessary and unnecessarily increases water and energy consumption.
- Make full use of the basket capacity without overloading the dishwasher. This results in the most economical dishwashing in terms of energy and water consumption.
- Choose the programme to suit the type of crockery being washed and the degree of soiling (see “Programme chart”).

- Select the  *ECO* programme for energy-saving dishwashing. This programme is the most efficient in terms of its combined energy and water consumption for cleaning crockery with a normal level of soiling.
- Follow the detergent manufacturer’s recommendations on detergent dosage.
- If you are manually dosing the detergent, reduce the amount of detergent by  $\frac{1}{3}$  when using powder detergent if the baskets are only half full.

You can find further tips on energy-saving dishwashing in Miele’s guide to dishwashing at [www.miele.com](http://www.miele.com).

## EcoFeedback consumption display

The "Consumption" function is used for calling up information about the water consumption of your dishwasher (see "Settings - Consumption (EcoFeedback)").

The following information can be viewed in the display:

- An estimate of the consumption before the programme begins
- The actual consumption at the end of the programme
- The total consumption of the dishwasher to date

### 1. Consumption estimate

After a programme has been selected, first the name of the programme and after a few seconds the estimated water consumption  $\delta$  will appear in the display.

The estimated consumption will be shown as a bar chart. The more bars that are shown (■■■), the higher the water consumption.

The values are influenced by the programme, any programme options selected, the ambient conditions and the size of the load.

The display will change automatically from showing the estimated consumption to showing the time remaining.

The estimated consumption function is activated as standard. It can be deactivated, if preferred (see "Settings - Consumption").

### 2. Displaying consumption

At the end of the programme, you can call up the actual water consumption for the programme that has just been run.

- Confirm the message Consumption (OK) with *OK*.

Switching the dishwasher off at the end of the programme will delete the actual consumption values for the programme that has just been completed.

### 3. Total consumption

You can call up the total consumption of water for all programmes you have run on your dishwasher to date (see "Settings - Consumption").

# Loading the dishwasher

---

## General information

Remove coarse food residues from crockery.

There is no need to pre-rinse items under running water.

 Damage can be caused by ash, sand, wax, lubricating grease, or paint.

These substances will contaminate the dishwasher and can then no longer be removed.

Do not wash items soiled with these substances in the dishwasher.

Dishes can be loaded anywhere in the baskets. However, please try to observe the following notes:

- Do not place dishes and utensils inside other items where they will cover one another.
- Load the crockery so that water can access all surfaces. This ensures that they will get properly cleaned.
- Make sure that all items are securely positioned.
- Hollow items such as cups, glasses, and saucepans etc. must be inverted in the baskets.
- Tall and narrow, hollow items such as champagne flutes should be placed in the centre of the basket rather than in the corners. This ensures the hollow items are more easily accessed by the water jets.
- Wide based items should be placed at an angle so that water can run off them freely.

- The spray arms must not be blocked by items that are too tall or hang through the baskets. Test for free movement by manually rotating the spray arms.
- Make sure that small items cannot fall through the holders in the baskets.  
Small items such as lids should be placed in the 3D MultiFlex tray or in the cutlery basket (depending on model).

Some foods such as carrots, tomatoes, or tomato sauce may contain natural dyes. These dyes can discolour plastic items in the dishwasher if large quantities of these foods are in contact with the crockery inside the machine. The stability of plastic items is not affected by this discolouration.  
Washing silverware can also cause plastic items to discolour.



## Items not suitable for washing in the dishwasher:

- Wooden cutlery and crockery or items with wooden parts. These may discolour and fade. Furthermore, the glue used in these items is not dishwasher safe. Wooden handles may come loose after being washed in the dishwasher.
- Craft items, antiques, valuable vases, and decorative glassware. Such items are not suitable for dishwashers.
- Plastic items that are not heat resistant. The high temperatures in the dishwasher may cause them to melt or lose shape.
- Copper, brass, tin, and aluminium items. These may discolour or become dull.
- Colours painted over a glaze. These may fade after a number of washes.
- Delicate glassware and glassware containing lead crystal. Clouding may occur over time.

## Silverware

Silverware that has been in contact with foods containing sulphur can discolour. These include egg yolk, onions, mayonnaise, mustard, pulses, fish, fish brine and marinades.

**Silverware** previously cleaned with a **silver polish** may still be damp or spotted at the end of a programme, as water has not run off smoothly.

**Useful tip:** Rub the silverware dry with a cloth.

 Damage due to caustic alkaline detergents.

Aluminium parts (e.g. the grease filters of rangehoods) can be damaged by caustic alkaline detergents. In extreme cases, there is a risk of an explosive chemical reaction (such as an explosive oxyhydrogen gas reaction).

Aluminium components must not be cleaned in the dishwasher with caustic alkaline commercial or industrial detergents.

**Useful tip:** When purchasing new crockery and cutlery, make sure they are dishwasher safe if you want to wash them in the dishwasher.

## Glass care

- Clouding may occur on glasses after frequent washing in the dishwasher. When washing delicate glassware in the dishwasher, ensure that only a special glass care programme with very low temperatures (see Programme chart) is selected. This will reduce the risk of clouding.
- Purchase glassware that is dishwasher safe (e.g. Riedel glassware).
- Use detergents with glass protective additives.
- Visit "<http://www.mieleglasscare.com>" for more information on glass care.

# Loading the dishwasher

## Upper basket

See “Loading the dishwasher - Loading examples” for examples of how to load crockery and cutlery.

## Loading the upper basket

 **Damage due to leaking water.**  
If you run the dishwasher without the upper basket, water can leak out of the dishwasher.  
Only run the dishwasher with the upper basket in place.

- Use the upper basket for small, lightweight, and delicate items such as cups, saucers, glasses, dessert bowls, etc.  
Shallow pans or casserole dishes can also be placed in the upper basket.
- Long items such as soup ladles and mixing spoons should be placed lying down across the front of the upper basket.

## Loading the FlexCare cup rack

You can put cups, small bowls, and flat dishes on the FlexCare cup rack. Glasses can be arranged along the cup rack so they sit securely during the programme.

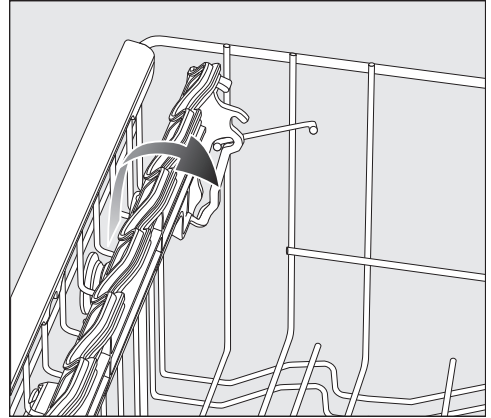

- Fold down the cup rack.
- Raise the cup rack upwards to make room for tall items.

# Loading the dishwasher

## Adjusting the FlexCare cup rack

You can set the height and depth of the cup rack at 2 different levels so that it can accommodate larger cups and so that taller items can be placed underneath it.

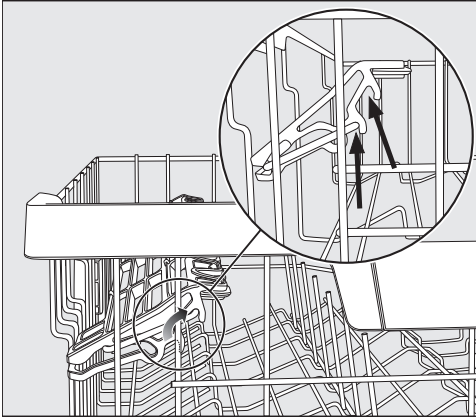

- Pull the cup rack upwards and click it into the desired position (see arrows).

## Loading the silicone elements of the FlexCare cup rack

The silicone elements on the cup rack are specially designed to hold tall glasses with long stems securely.

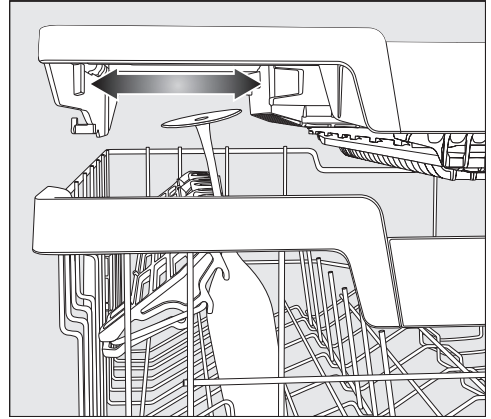

- Fold down the cup rack and lean the glasses in the openings.
- If you wish you can adjust the left insert of the 3D MultiFlex tray to make space for taller glasses (see “Cutlery tray – Loading the 3D MultiFlex tray”).

# Loading the dishwasher

---

## Lowering the spikes

You can fold down every second spike in the two right-hand rows of spikes to make it easier to arrange larger pieces of crockery, e.g. cereal bowls.

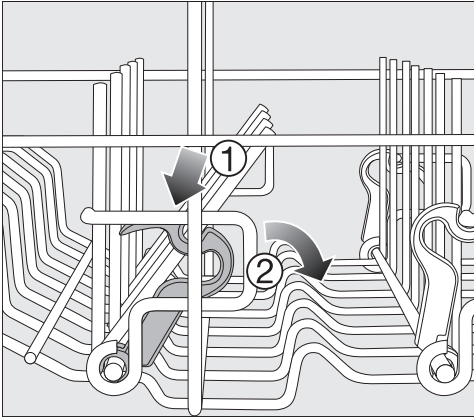

- Press the yellow lever downwards ① and then lower the dark gray spikes ②.
- Place the items vertically in the row of spikes.

## Adjusting the upper basket

In order to gain more space for taller items, the upper basket can be adjusted on three levels with 2 cm between each level.

The upper basket can also be set at an angle so that water can run off freely from recesses. Make sure, however, that the basket can slide smoothly in and out of the wash cabinet.

- Pull out the upper basket.

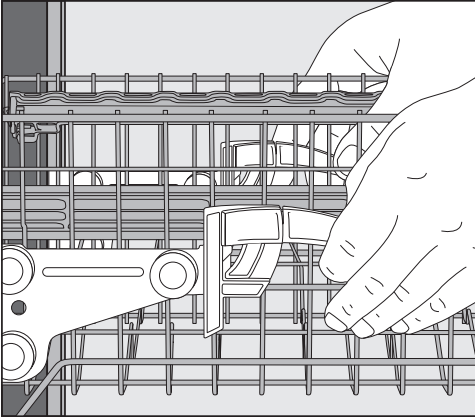

## To raise the upper basket:

- Lift the basket up until it clicks into place.

## To lower the upper basket:

- Pull upwards on the levers at either side of the upper basket.
- Adjust the basket to the desired height and then push the levers securely back down into position.

When adjusting the upper basket, make sure items in the lower basket do not block the middle spray arm.

# Loading the dishwasher

## Lower basket

See “Loading the dishwasher - Loading examples” for examples of how to load crockery and cutlery.

### Loading the lower basket

- Place larger and heavier items such as plates, serving platters, saucepans, serving bowls etc., in the lower basket.  
Glasses, cups and small plates and saucers can also be placed in the lower basket.

### Loading the MultiComfort area

The rear section of the lower basket is used for washing cups, glasses, plates, and saucepans.

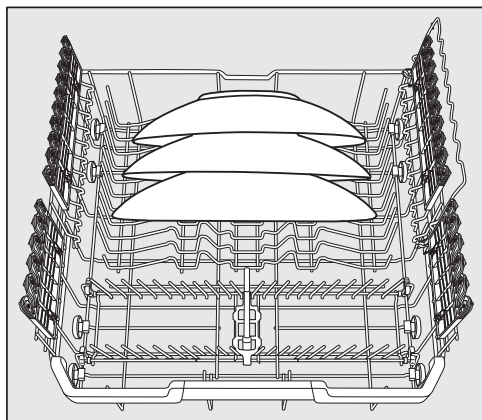

- Place large platters and dishes in the centre of the lower basket.

**Useful tip:** When tilted, plates up to 35 cm in diameter can be accommodated.

## Lowering the spikes

The rows of spikes at the front are used for washing plates, soup bowls, platters, dessert bowls and saucers.

Both rows of spikes can be lowered to make more room for large items such as pots, pans and serving dishes.

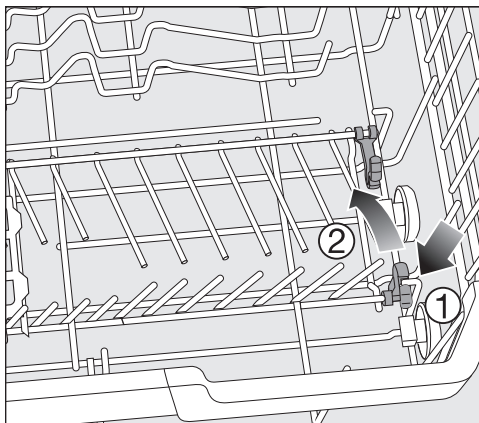

- Press the yellow lever downwards ① and then lower the spikes ②.

# Loading the dishwasher

## Loading the FlexCare glass holders with MultiClips

The silicone elements in the glass holders provide a stable and secure hold for delicate stemware.

- Stemware such as wine glasses and champagne flutes can be leaned against the glass holder or suspended from it.
- The glass holder can be raised to make more room for tall items.

You can set the glass holder at two different heights.

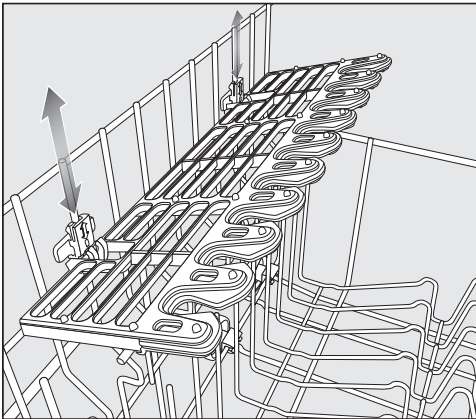

- Slide the glass holder to the desired height until the catches click into place at the top or the bottom.

The MultiClips allow you to fasten light items such as plastic parts onto the glass holder.

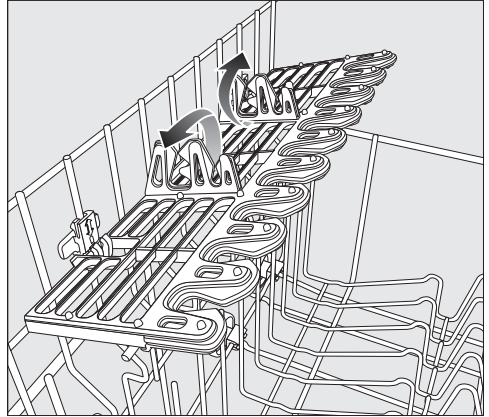

- Tilt up the MultiClips.

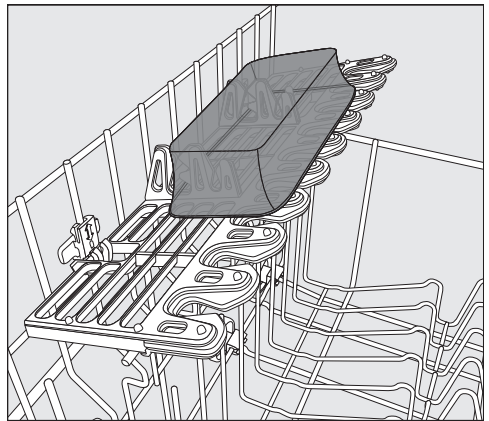

- Secure light items to the MultiClips.

# Loading the dishwasher

## Loading the glassware rail

This rail is designed to hold glasses with long stems securely.

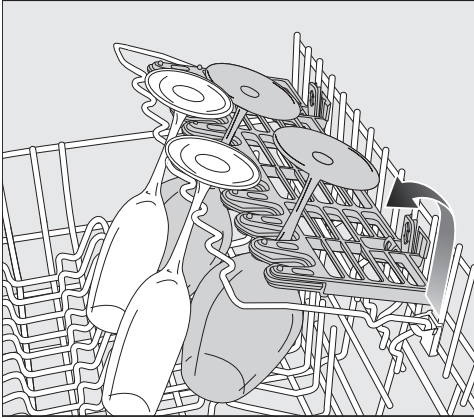

- Lower the glass rail and lean the glasses against it.

## Lowering the bottle holder

The bottle holder can be used to keep narrow items such as milk bottles and baby bottles secure during a programme.

- Tilt the bottle holder up and push it down until it clicks into place.

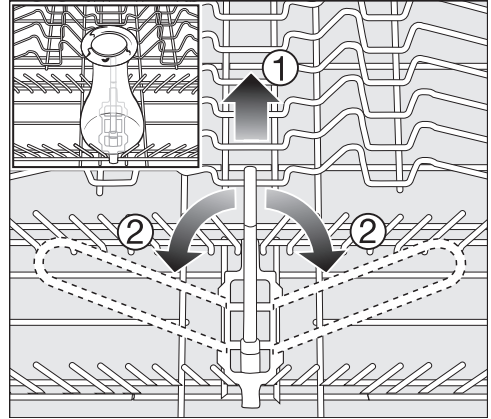

- If the bottle holder is not needed, lift it up using the yellow lever ① and fold it to the side ②.



# Loading the dishwasher

## Cutlery tray

See “Loading the dishwasher - Loading examples” for examples of how to load crockery and cutlery.

- Load cutlery into the 3D MultiFlex tray.

### Loading the 3D MultiFlex tray

To make unloading easier, cutlery should be grouped in zones: one for knives, one for forks, one for spoons, etc.

Spoon heads should be placed to rest on the serrated retainers on the base of the tray to ensure that water runs off them freely.

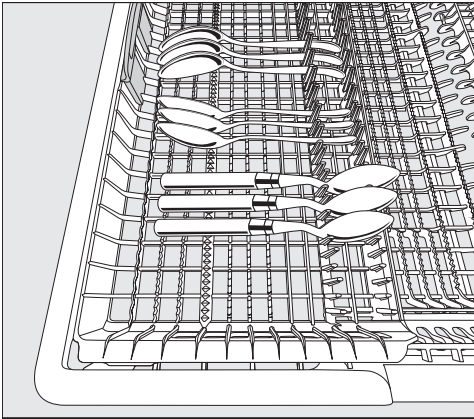

- If spoon handles do not fit between the holders, lay them the other way round.

You can push the left insert to the middle in order to accommodate tall items of crockery and long stemmed glasses in the upper basket (see “Upper basket – Loading the silicone elements of the FlexCare cup rack”).

You can put large and long cutlery (such as salad servers and chef’s knives) in the recessed centre part of the tray.

Arrange tall items (such as cake servers) so that they do not block the upper spray arm.

You can adjust the height of the right-hand insert to create more space in the right-hand part of the tray for larger cutlery items or smaller pieces of crockery.

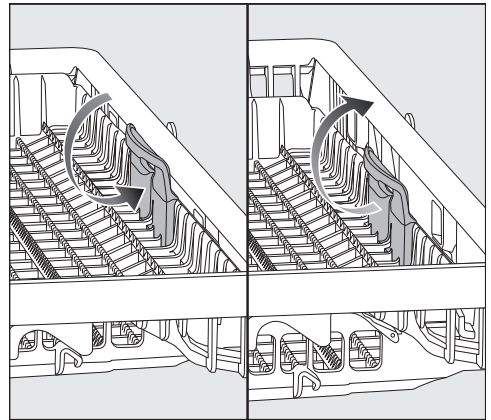

- Pull the insert inwards by the yellow handle and click it into place in one of the two positions.

# Loading the dishwasher

---

## Loading examples

### Dishwashers with cutlery tray

#### Upper basket

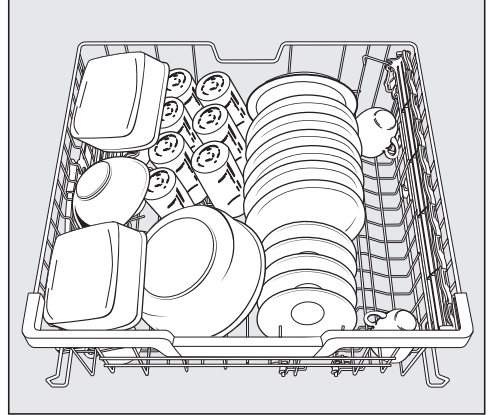
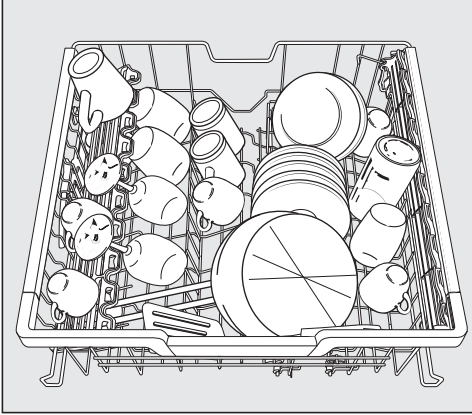

#### Lower basket

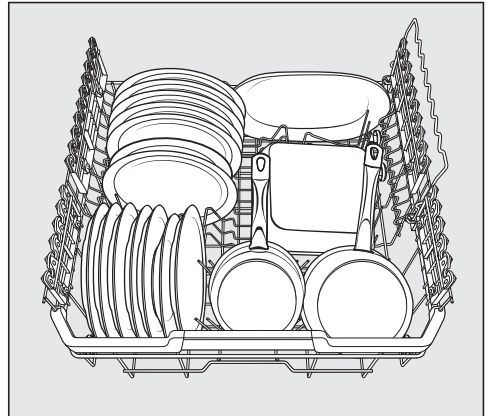
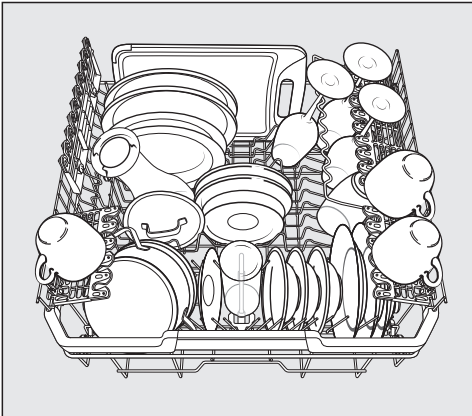

# Loading the dishwasher

## Cutlery tray

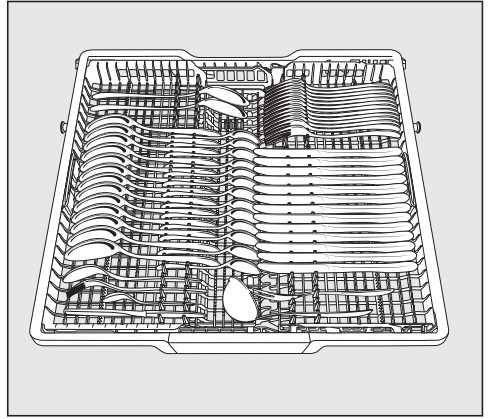
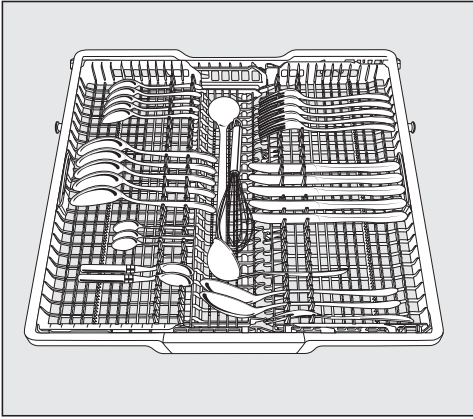

## Heavily soiled items

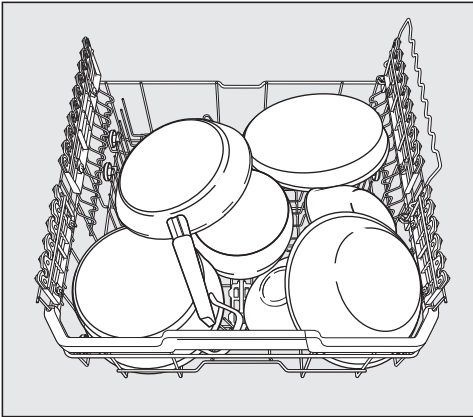

# Comparison tests

---

<b>Test standard:</b>	AS/NZS 2007.1, AS/NZS 2007.2; AS/NZS 6400
<b>Standard programme</b> (for energy label):	ECO
<b>Capacity:</b>	 14 place settings
<b>Detergent amount:</b>	32.5 g
<b>Rinse aid dosage:</b>	Setting 3

You can find information on adjusting the rinse aid dosage in the "Rinse aid" section of this booklet.

The door opens automatically during the drying phase.  
Do not close the door until the drying test has finished.

## Upper basket setting:

Position:	Bottom
FlexCare cup rack (if available):	Left lower position, right upper position

## Loading examples

Pictures illustrating how to load the dishwasher for each model (see data plate) are shown on the following pages.

Picture ①: Upper basket

Picture ②: Lower basket

Picture ③: Cutlery basket

Do not lower or remove the basket inserts.

Squeeze and remove the bottle holder from the lower basket  
(if available).

## Capacity

 14

# Comparison tests

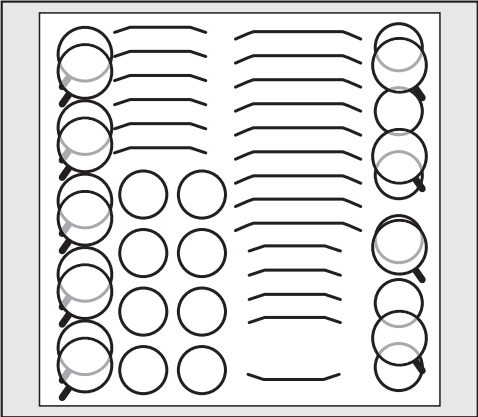

Upper basket

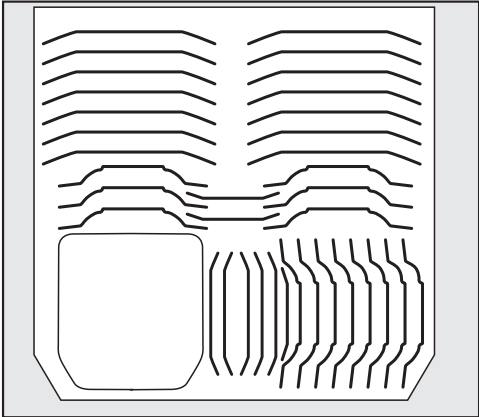

Lower basket

# Comparison tests

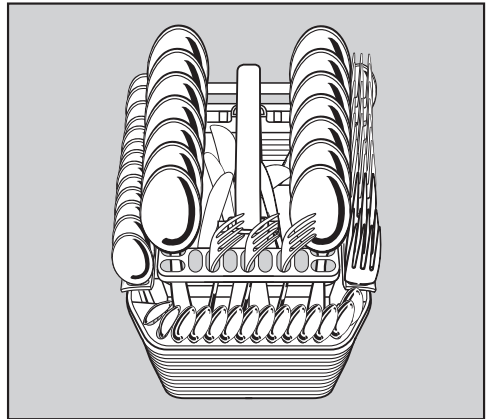
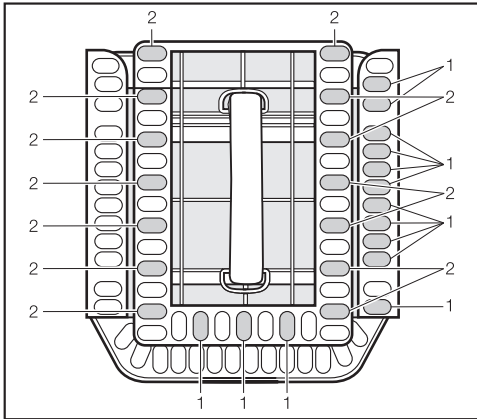
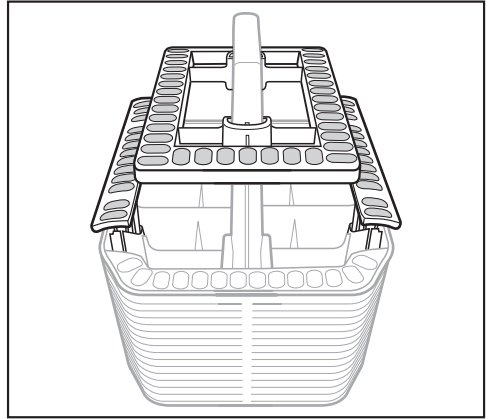
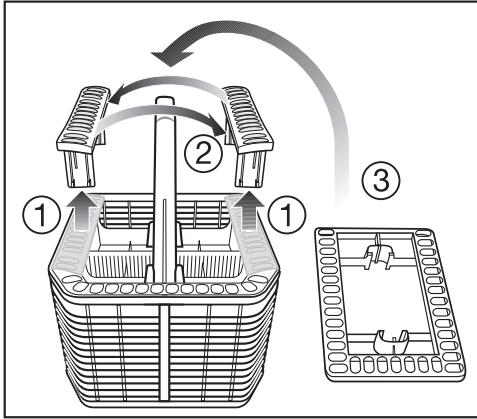

Cutlery basket

1 fork

2 soup spoons

## XXL height with cutlery tray

**Test standard:** AS/NZS 2007.1, AS/NZS 2007.2;  
AS/NZS 6400

**Standard programme for energy label comparison tests:** ECO

**Capacity:** 🍴 | 15 place settings

**Detergent quantity:** 33.7 g in compartment II

**Rinse aid dispensing:** Setting 3

You can find information on adjusting the rinse aid dosage in the “Rinse aid” section of this booklet.

### Upper basket level:

**Position:** Bottom

**Jumbo cup rack (if available):** Outer position

## Loading examples

Pictures illustrating how to load the dishwasher are shown on the following pages.

Picture ①: Upper basket

Picture ②: Lower basket

Picture ③: Cutlery tray

Do not lower or remove the basket inserts.

Remove the bottle holder from the lower basket (if available).

The door automatically opens during the drying phase. Do not close the door until the drying test is finished.

# Comparison tests

---

## Capacity

🗂️ 15

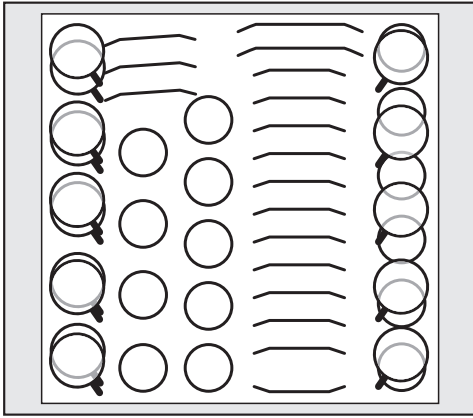

①

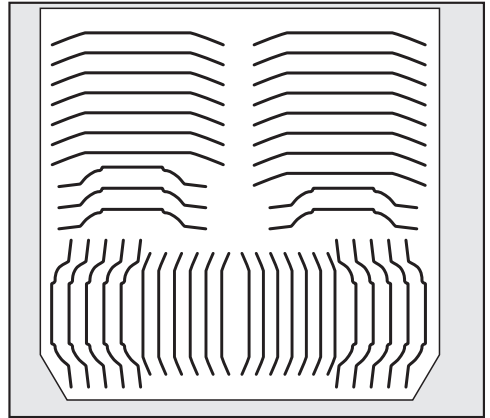

②



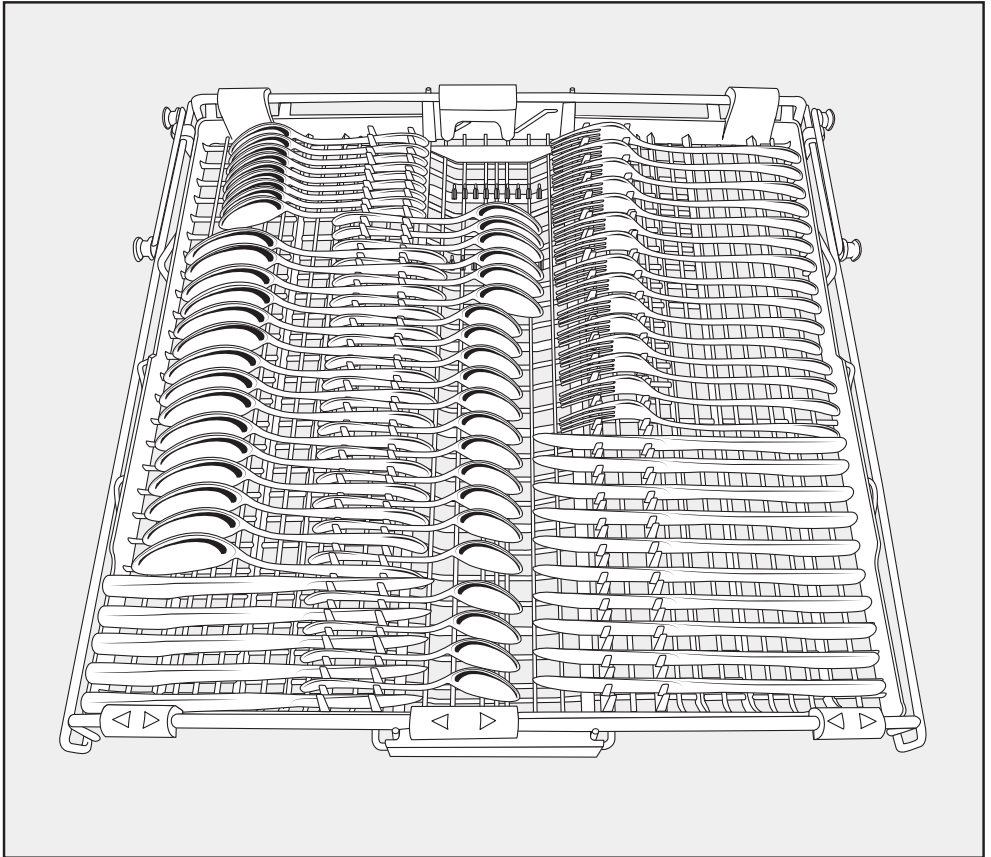

3

# Detergent

 Risk of chemical burns from detergent.

Dishwasher detergents can cause burning on the skin and in the eyes, nose, mouth, and throat.

Avoid contact with detergents.

Do not inhale powder detergent. Do not swallow dishwasher detergent.

Seek medical attention immediately if detergent has been swallowed or inhaled.

Keep detergents out of reach of children. Detergent residues could still be present in the machine. Keep children away from the dishwasher when the door is open. Do not fill the detergent dispenser until just before starting the programme and activate the door safety lock (depending on model).

 Damage can be caused by detergents containing active chlorine.

Powder and liquid detergents containing active chlorine must not be used. You may damage plastic parts and the seals of the dishwasher.

Do not use detergents containing active chlorine.

## Application

The detergent selected should match the setting in which it is being used. If the dishwasher is being used in a **commercial setting**, commercial detergents are recommended. Some detergents for commercial use in your dishwasher can be ordered on the Miele website:

<https://www.miele.com.au/professional/accessories-dishwashers-441.htm>



If the dishwasher is being used in a **domestic setting**, detergents for domestic dishwashers are recommended, e.g. from the Miele product range.

Powder detergent and other consumables for use in a domestic setting can be conveniently ordered via the Miele@mobile App or on the Miele website:

<https://www.miele.com.au/domestic/miele-dishwasher-detergents-1812.htm>



## Powder detergent and detergent tabs

Use powder detergent or detergent tabs only in the door dispenser compartment.

Only use detergent tabs that are quick dissolving. Suitable tabs are available from the Miele detergent range. If you are using combination detergents (tabs which contain not only a cleaning function, but also rinse aid and water softening functions), depending on the water quality, it is recommended to add rinse aid and reactivation salt due to the short programme running times.

- Add powder detergent or detergent tabs to the detergent compartment.

## Detergent dispensing

The detergent compartment holds a maximum of 50 ml.

There are marks in the detergent compartment to aid with dispensing: 20, 30, max. When the door is opened to a horizontal position, they show the approximate fill level in ml and the maximum fill height.

They also indicate the approximate fill level in grams for powder cleaning agents, depending on the manufacturer and the coarseness.

- Follow the detergent dosage recommended by the manufacturer on the packaging.
- Unless directed otherwise, use one detergent tab or add 20 to 30 ml of detergent to the detergent compartment, depending on the degree of soiling of the crockery.

If you use less than the recommended amount of detergent, the dishes may not get properly clean.

# Detergent

## Adding detergent



- Lift the yellow catch on the lid of the detergent compartment .

The lid will open.

The lid will also be open at the end of the programme.



- Add the detergent to the detergent compartment.
- Push the lid shut until you hear it click into place.

The detergent must not cause the detergent compartment lid to get stuck. This can prevent the lid from opening during the programme sequence.

Do not overfill the detergent compartment.

- Ensure that the detergent packaging is properly closed after use. This prevents the detergent from getting damp and clumping together.

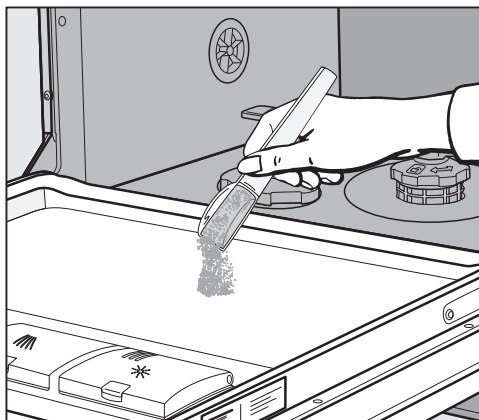

- You can also apply a small amount of detergent to the inner panel of the door in programmes that have a pre-wash stage (see “Programme chart”).

## Liquid detergent

This dishwasher can be fitted with an external dispenser pump for liquid detergent (DOS module).

See “Settings menu - External dispensing” to activate the dispenser pump and set the cleaning agent dosage.

For special soiling or if using liquid detergent dispensed by a liquid detergent pump, contact Miele for advice on how to adapt the detergent dosage to the particular circumstances.

## Refilling or changing containers

The DOS module is equipped with a level indicator which shows the message *Refill detergent* in the display when the level drops below the minimum.

- As soon as the message appears in the display, refill or replace the container with a full one at the end of the programme.
- Confirm the message shown with the *OK* button.

Replace the container in good time to prevent the dispensing system being emptied completely. An empty dispensing system must be vented before starting the next programme.

- Place the container on the open cabinet door or on a surface which is easy to clean.

- Take the lid off the container and remove the suction lance. Place the suction lance on the open wash cabinet door.
- Fill or replace the container, fit the suction lance and secure the lid. Observe the colour coding.

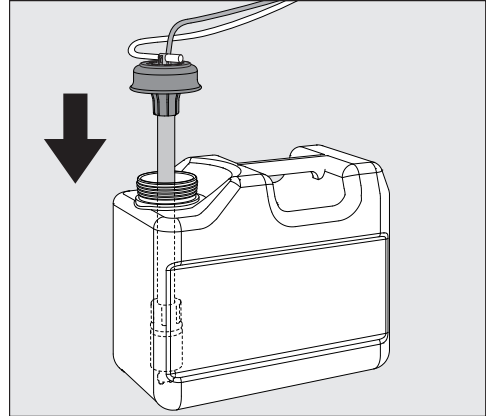

- Feed the suction lance into the container until it reaches the bottom.
- Wipe up any spilled process chemical thoroughly.
- Place the container on the floor beside the dishwasher or in an adjacent cupboard. The container must be at the same level as the machine and not be placed on top of or above the machine.
- The DOS system must then be vented.

## Checking consumption

Monitor the amount of process chemicals used by regularly checking the level in the container in order to detect any dispensing irregularities.

# Detergent

---

## Changing detergent



If you want to change the cleaning agent, the dispensing system must first be rinsed with water in order to avoid a reaction due to the mixing of cleaning agents.

- Remove the suction lance from the container and place it in a container of water.
- Start "Vent dispensing system" **twice** (see "Settings menu - External dispensing") to rinse the dispensing system.
- Then place the suction lance in the new container and start "Vent dispensing system" again.

The dispensing system is now ready to use.

Always follow the recommendations of the cleaning agent manufacturer whether using powder or liquid cleaning agent.

## Switching on the dishwasher

- Make sure the spray arms can rotate freely.
- Close the door.
- Turn on the tap if it is turned off.
- Touch the  sensor.  
If the dishwasher has been switched off for longer than 1 minute, you will need to touch the  sensor for slightly longer (wipe protection).

 *ECO* will appear briefly in the display and the appropriate sensor will be illuminated.

Next, the estimated energy and water consumption may be shown for the selected programme for several seconds.

Then the display will show the estimated duration for the selected programme.

The *Start* sensor flashes.

## Selecting a programme

Choose your programme according to the type of crockery and the degree of soiling.

The different programmes and their uses are described in the **Programme chart** later on in this booklet.

- Touch the sensor for the programme you want.

The sensor for the selected programme will light up.

You can now select programme options (see "Programme options").

If any programme options are selected, the appropriate sensor will light up.



# Operation

---

## Display of programme duration

The estimated duration of the selected programme appears in the display before the programme starts. During the programme, the time left until the end of the programme is displayed.

Symbols appear to indicate which stage the programme is at:

-  Pre-wash / Soak
-  Main wash
-  Interim rinse
-  Final rinse
-  Drying
-  Finish

The displayed duration may vary for the same programme. It is influenced by, for example, the temperature of the incoming water, the reactivation cycle of the water softener, the amount of crockery and how soiled it is.

When a programme is selected for the first time, the display will show the average programme duration for a warm water connection.

The programme durations shown in the “Programme chart” refer to standard test loads and temperatures.

Each time a programme is run, the control module calculates the programme duration depending on the temperature of the water taken into the dishwasher and the size of the load.

## Starting a programme

- Touch the *Start* sensor.  
Confirm the previously displayed message with *OK*.

The programme will start.

The *Start* sensor will light up continuously.

During a programme, you can display the programme name of the current programme by pressing *OK*.

 Risk of scalding due to hot water.

During operation, water in the dishwasher may be very hot.

Only open the door if absolutely necessary and exercise extreme caution when doing so.



## At the end of the programme

The signal tones may sound at the end of the programme.

The programme has finished when the display shows the message  Finished.

In some programmes, if the AutoOpen function is activated, the door will automatically open slightly (see “Settings – AutoOpen”). This improves the drying process.

If the Consumption programmable function is switched on, you can now call up the actual energy and water consumption of the programme that has just finished (see “Caring for the environment – EcoFeedback consumption display”).

The drying fan may continue to run for a few minutes at the end of the programme.

 Risk of damage due to steam. Steam from the dishwasher could damage the edges of delicate worktops when you open the door at the end of the programme if the fan is no longer running. If you have deactivated the automatic door opening function (see “Settings – AutoOpen”), but would still like to open the door at the end of the programme, then make sure that you open the door fully.

## Energy management

To save energy, the dishwasher will switch off automatically 10 minutes after the last time a sensor is pressed or after the end of a programme.

You can switch the dishwasher back on again with the  sensor.

If the dishwasher has been switched off for longer than 1 minute, you will need to touch the  sensor for slightly longer (wipe protection).

The dishwasher will not switch itself off while a programme is running or if there is a fault.

# Operation



---

## Switching off the dishwasher

- The dishwasher can be switched off at any time using the  sensor.

An ongoing timer can also be cancelled by switching off the machine.

Switching the dishwasher off during a programme cancels the programme.

- Confirm the query *Switch appliance off with OK.*
- If you have touched the  sensor, but in fact do not wish to cancel the programme, use the  sensor to select the *Do not switch off* option in the display and confirm with *OK.*



Risk of damage from leaking water.

Overflowing water can cause damage.

If the dishwasher is not going to be used for a longer period of time, e.g. whilst on holiday, the tap should be turned off.

## Unloading the dishwasher

Dishes tend to break and chip more easily when they are hot. Allow the dishes to cool until they are comfortable enough to handle before unloading them.

The dishes will cool much faster if you open the door fully after switching off the dishwasher.

- First unload the lower basket, then the upper basket, and finally the 3D MultiFlex tray (if available). This will prevent water drops from the upper basket and 3D MultiFlex tray from falling onto the dishes in the lower basket.

## Interrupting a programme

A programme will be interrupted as soon as the door is opened.

When you close the door again, the query *Continue with Start* appears in the display.

By pressing the *Start* sensor, the programme will continue from the point at which it was interrupted.



Risk of scalding due to hot water.

During operation, water in the dishwasher may be very hot.

Only open the door if absolutely necessary and exercise extreme caution when doing so.

## Cancelling or changing a programme

If a programme is cancelled, important programme stages may be missed.

A programme should only be cancelled in the first few minutes of the programme sequence.

If a programme has already started and you wish to cancel it, proceed as follows:

- Switch the dishwasher off with the  sensor.
- Confirm the query *Switch appliance off with OK*.

If you would like to select another programme:

- Switch the dishwasher back on using the  sensor.
- If you have dispensed detergent manually, check whether the detergent compartment is still closed. If the lid is already open, fill it with detergent again and close the lid.
- Select the programme you want and start it.

# Programme options

---

## Options

Options can be selected and deselected using the appropriate buttons and the display before starting the programme.

The time remaining and temperature options can be changed during the programme.

- Switch the dishwasher on by touching the  sensor.

The *Start* sensor flashes.

- Select a programme.
- Press the button for the option you want.

The indicator light for the relevant button will come on if the option is available for the programme selected.

If the option is not compatible with the programme selected, a message to this effect will appear in the display.

- In this event, confirm the message with *OK*.
- Press the *Start* sensor to start the programme.

The option selected will remain active for that particular programme until the setting is changed.

## Time left indicator

The time left indicator  option is selected as standard and displays the time remaining until the end of the programme.

You can also switch to the Temperature  while the programme is running.

## Temperature

The Temperature  option shows the current temperature of the wash block.

You can also switch to the time left indicator  while the programme is running.

## Extra dry

The Extra dry  option improves the drying performance in programmes in which this option is available.

Energy consumption is increased due to an extended fan running time.

If the AutoOpen function has been activated, the door will automatically open at the end of the programme.

## Settings

The Settings  option opens the menu to enable settings to be selected on the machine and changes to be made to programme parameters.

See "Settings" for more information.

## Timer

The timer  gives you several options for starting a programme at a later time. You can set the start time or the finish time of a programme. You also have the option of taking advantage of time variable electricity rates using the EcoStart or SmartStart functions.

With manual detergent dispensing, the detergent can clump together if the detergent compartment is not dry, and it may not be fully rinsed out.

When using the timer function, make sure that the detergent compartment is dry before adding detergent. Wipe it dry with a cloth first if necessary. Do not use liquid detergents. These can leak out.

 Danger to health due to detergent.

To prevent children coming into contact with dishwasher detergent: Do not fill the detergent dispenser **until just before starting the programme**, i.e. before you activate the timer. Use the safety lock to secure the dishwasher door.

## Activating the timer

- Switch the dishwasher on using the  sensor.

The *Start* sensor flashes.

- Select the required programme.
- Touch the  sensor.

The  sensor lights up.

You can use the  $\nabla/\wedge$  sensors to choose between the *Start at*, *Finish at* and *EcoStart* functions, or *SmartStart* if applicable.

- Confirm the selected function with *OK*.

The last time set for the timer will be displayed and the hour number block will be highlighted.

- Enter the required time for the timer using the  $\nabla/\wedge$  sensors and confirm with *OK*.

If, while you are setting the time, you do not apply any settings for several seconds, the display will revert to the previous menu. You will then have to enter your settings again.

After you have activated the timer, the display and the indicator lights will switch off after a few minutes to save energy.

To switch the display back on for a few minutes, press the  sensor.

You can also activate the timer via the Miele@mobile App.

# Programme options

---

## Setting “Start at”

With the *Start at* function, you set the exact time at which you want the programme to start.

- Use the  $\vee/\wedge$  sensors to enter the hour and confirm your entry with *OK*.

The hour will be saved and the minute number block will be highlighted.

- Use the  $\vee/\wedge$  sensors to enter the minutes and confirm your entry with *OK*.

The saved start time for the selected programme will appear in the display for several minutes.

When the set time is reached, the selected programme will start automatically.

The time remaining will be shown in the display, the  $\oplus$  sensor will go out and the *Start* sensor will light up.

## Setting “Finish at”

Use the *Finish at* function to set the latest time by which the selected programme has to be finished.

- Use the  $\vee/\wedge$  sensors to enter the hour and confirm your entry with *OK*.

The hour will be saved and the minute number block will be highlighted.

- Use the  $\vee/\wedge$  sensors to enter the minutes and confirm your entry with *OK*.

The estimated start time for the selected programme will appear in the display for several minutes.

A message will appear in the display if the programme cannot be completed by the set finish time because it has too long a running time.

- In this case, confirm the message with *OK*.

The programme will start automatically when the estimated start time is reached.

The time remaining will be shown in the display, the  $\oplus$  sensor will go out and the *Start* sensor will light up.

## Setting EcoStart

The EcoStart function enables you to benefit from time variable economy electricity rates. Before you can use this option, you need to set up to three electricity rate tariff times (see “Settings - EcoStart”).

Then set the time by which the selected programme has to be finished.

The dishwasher will then start automatically in the most economical electricity rate zone within the time set.

- Use the  $\vee/\wedge$  sensors to enter the hour and confirm your entry with *OK*.

The hour will be saved and the minute number block will be highlighted.

- Use the  $\vee/\wedge$  sensors to enter the minutes and confirm your entry with *OK*.

The estimated start time for the selected programme will appear in the display for several minutes.

The programme will start automatically when the estimated start time is reached.

The time remaining will be shown in the display, the  $\oplus$  sensor will go out and the *Start* sensor will light up.

## Setting SmartStart

The SmartStart function (only functional in selected countries) is used for starting your dishwasher automatically at a time when energy costs are most economical.

To use this function you may need further technical accessories.

If you have activated the SmartStart function in the Settings  $\blacksquare$  menu, the *Timer*  $\oplus$  menu will no longer show the EcoStart function but will instead show SmartStart (see “Settings - Miele@home”).

If your energy provider offers this service, they will send a signal to your dishwasher when energy costs are at their most economical.

This signal will start the dishwasher.

You can set the time by which the selected programme has to be finished. The dishwasher will then calculate the latest possible start time for the selected programme and will wait until this start time for the signal from the energy provider.

## Programme options

---

Set the time by which the selected programme needs to be finished.

- Use the  $\vee/\wedge$  sensors to enter the hour and confirm your entry with *OK*.

The hour will be saved and the minute number block will be highlighted.

- Use the  $\vee/\wedge$  sensors to enter the minutes and confirm your entry with *OK*.

The message *Waiting for SmartStart* will appear in the display.

The *Start* sensor lights up for a few minutes.

The selected programme will start automatically as soon as the energy provider has sent the signal or when the latest possible calculated start time has been reached.

The time remaining will be shown in the display, the  $\oplus$  sensor will go out and the *Start* sensor will light up.

### Changing or deleting the timer

You can change the time set for the timer or delete it.

- Touch the  $\oplus$  sensor.
- Use the  $\vee/\wedge$  sensors to select the previously activated timer function and confirm your entry with *OK*.
- Use the  $\vee/\wedge$  sensors to select the *Change* or *Delete* function and confirm with *OK*.

After confirming the *Change* function with *OK*, you can change the time set for the timer.

After confirming the *Delete* function with *OK*, the duration of the selected programme will appear in the display. The  $\oplus$  sensor goes out and the *Start* sensor flashes.

You can now start a programme or switch the dishwasher off.



Switching the dishwasher off while a timer is running stops the timer.

You can also change the time set for the timer or delete it using the *Miele@mobile* App.



### Activating Remote start

You can start your dishwasher remotely using the Miele@mobile App. To do this, you first need to install the App on your mobile device, connect the dishwasher to your Wi-Fi network (see “Settings - Miele@home”), and, if applicable, activate the Remote control option (see “Settings - Remote control”).

- Switch the dishwasher on using the  sensor.
- Touch the  sensor when the door is closed.

The  sensor lights up.

The remote control function for the dishwasher using the Miele@mobile App must be reactivated each time the door is opened before a programme is started.









The dishwasher can now be operated remotely using the Miele@mobile App.

The Remote start option will remain activated until you deactivate it again using the  sensor. The option will also remain active if you switch the dishwasher off and back on in the meantime.

Even if the Remote start option is not active, you can check the status of your dishwasher and apply settings using the Miele@mobile App.

If you start a programme using the *Start* sensor on the dishwasher, the Remote start option will automatically be activated for the duration of the programme and the  sensor will light up.

# Programme chart

Programme	Application	Detergent
		Detergent compartment  <sup>1)</sup>
 Short	For fresh, non-sticky food residues.	20–25 g or 1 tab
 Medium	For moderately dried-on food residues.	20–25 g or 1 tab
 Intensive	For burnt-on, stubborn, dried-on food deposits containing starch or protein <sup>1)</sup> .	20–25 g or 1 tab
 Plastics	Special plastics programme.	20–25 g or 1 tab
 Glasses	Special glassware programme.	20–25 g or 1 tab
 Hygiene	Special hygiene programme for hygienically demanding crockery.	20–25 g or 1 tab
 Cold pre-wash	For rinsing heavily soiled items, e.g. for initial removal of soil or to prevent residues drying on to dishes when a complete programme does not yet need to be run.	
 ECO <sup>*)</sup>	Energy-saving programme for normally soiled food residues.	20–25 g or 1 tab

<sup>\*)</sup> This programme is the most efficient in terms of its combined energy and water consumption for cleaning crockery with a normal level of soiling.  
(fixed programme sequence which cannot be altered)

<sup>1)</sup> see "Detergent"

# Programme chart

Programme sequence					
Pre-wash	Main wash	Interim rinse	Final rinse	Drying	AutoOpen
	X 60-65 °C <sup>2)</sup> 1 min	X 40 s	X 65 °C <sup>3)</sup> 30 s	(X) 20 min <sup>4)</sup>	(X)
	X 65 °C 6 min	X 3 min	X 65 °C <sup>3)</sup> 2 min	(X) 30 min	(X)
X 6 min	X 75 °C 6 min	X 3 min	X 65 °C <sup>3)</sup> 2 min	(X) 30 min	(X)
X 6 min	X 50 °C 1 min	X 5 min	X 60 °C 1 min	X 30 min	(X)
	X 50 °C 1 min	X 3 min	X 50 °C 2 min	(X) 20 min	(X)
X 8 min	X 60 °C 10 min	X 3 min	X 82 °C 2 min	X 30 min	(X)
	X Cold 10 min				
	X 51.5 °C 44 min	X 4 min	X 48 °C 10 min	X 127 min	(X)







X = stages included in a programme

(X) = optional stages which can be selected (see "Programme options - Options")

<sup>2)</sup>The temperature which is able to be reached depends on the load items, size of load and the water intake temperature. <sup>3)</sup> Optional temperature increase to 82 °C.

<sup>4)</sup> With temperature increased to 82 °C, drying time increases to 30 min.







# Programme chart

Programme	Consumption <sup>6)</sup>						Duration <sup>6)</sup>			
	Electrical energy				Water		Cold water 15 °C		Hot water 55 °C	
	Cold water 15 °C		Hot water 55 °C		2.1 kW	7.3 kW				
	2.1 kW	7.3 kW	2.1 kW	7.3 kW	2.1 kW	7.3 kW	2.1 kW	7.3 kW	2.1 kW	7.3 kW
 Short	1.4 kWh		0.9 kWh		14.7 l		53 min 7)	22 min 7)	36 min 7)	17 min 7)
 Medium	1.5 kWh		1.0 kWh	0.9 kWh	14.8 l		65 min 7)	34 min 7)	49 min 7)	31 min 7)
 Intensive	1.7 kWh		1.0 kWh		19.2 l		79 min 7)	48 min 7)	58 min 7)	43 min 7)
 Plastics	1.3 kWh	1.2 kWh	0.6 kWh	0.5 kWh	19.5 l		90 min	65 min	68 min	60 min
 Glasses	1.0 kWh		0.4 kWh		15.3 l		43 min 7)	23 min 7)	27 min 7)	19 min 7)
 Hygiene	1.9 kWh	1.8 kWh	1.2 kWh	1.1 kWh	19.2 l		85 min 7)	53 min 7)	65 min 7)	47 min 7)
 Cold pre-wash	0.02 kWh		0.02 kWh		4.5 l		13 min		13 min	

<sup>6)</sup> Values are calculated in accordance with EN 50242 for a rated load of 2.1 and 7.3 kW. In practice considerable variations may be noted due to differing conditions. The duration displayed is adjusted to the on-site conditions.

<sup>7)</sup> The figure refers to the wash duration without drying.

# Programme chart

Programme	Consumption <sup>6)</sup>						Duration <sup>6)</sup>			
	Electricity				Water		Cold water 15 °C		Hot water 55 °C	
	Cold water 15 °C		Hot water 55 °C		3.2 kW	5.1 kW				
	3.2 kW	5.1 kW	3.2 kW	5.1 kW	3.2 kW	5.1 kW	3.2 kW	5.1 kW	3.2 kW	5.1 kW
 Short	1.4 kWh		0.9 kWh		14.7 l		39 min 7)	28 min 7)	28 min 7)	20 min 7)
 Medium	1.5 kWh		1.0 kWh h	0.9 kWh h	14.8 l		49 min 7)	39 min 7)	39 min 7)	32 min 7)
 Intensive	1.7 kWh		1.0 kWh		19.2 l		65 min 7)	55 min 7)	50 min 7)	46 min 7)
 Glasses	1.0 kWh		0.4 kWh		15.3 l		34 min 7)	27 min 7)	23 min 7)	21 min 7)
 Hygiene	2.0 kWh	1.9 kWh	1.3 kWh	1.2 kWh	19.2 l		72 min 7)	62 min 7)	58 min 7)	53 min 7)
 Plastics	1.3 kWh	1.2 kWh	0.6 kWh	0.5 kWh	19.5 l		79 min	70 min	64 min	61 min
 Cold pre-wash	0.02 kWh		0.02 kWh		4.5 l		13 min		13 min	

<sup>6)</sup> Values are calculated in accordance with EN 50242 for a connected load of 3.2 kW and 5.1 kW. In practice considerable variations may be noted due to differing conditions. The duration displayed is adjusted to the on-site conditions.

<sup>7)</sup> The figure refers to the wash duration without drying.

# Programme chart

## Consumption data in ECO programme

Programme	Consumption <sup>8)</sup>			Duration <sup>8)</sup> (Programme time)	
	Electrical energy		Water	Cold water 20 °C	Hot water 60 °C
	Cold water 20 °C	Hot water 60 °C	(20 °C)		
ECO 14 standard place settings	0.6 kWh	0.9 kWh	13.1 l	178 min	171 min
ECO 15 standard place settings	0.6 kWh	0.9 kWh	13.2 l	180 min	169 min

<sup>8)</sup> Values for the *ECO* programme were calculated under standardised testing conditions. In practice, the selected settings, programme options or operating conditions may result in different values.

## Maintenance

To prolong the service life of the dishwasher, maintenance should be carried out **at least once a year** by Miele Professional Service.

Maintenance covers the following:

- Electrical safety according to national regulations
- Door mechanism and door seal
- Any screw connections and connectors in the wash cabinet
- Water inlet and drainage
- Internal and external dispensing systems
- Spray arms
- Filter combination
- Sump including drain pump and non-return valve
- All baskets and inserts

The following operational tests will be carried out as part of the maintenance:

- A programme will be run as a test run
- Seals will be tested for water tightness
- All relevant measuring systems will be safety tested, including fault displays
- Safety features

Check the condition of your dishwasher regularly (approx. every 4–6 months). This way, faults and problems can be avoided.

 Damage caused by unsuitable cleaning agents.

All surfaces of this appliance are susceptible to scratching. Contact with unsuitable cleaning agents can alter or discolour the external surfaces.

Only use cleaning agents formulated for use on the relevant surfaces.

## Cleaning the wash cabinet

The wash cabinet is largely self-cleaning, provided that the correct amount of detergent is always used.

If, despite this, limescale or grease deposits build up in the cabinet, these can be removed with a proprietary dishwasher cleaner (available from Miele directly or the Miele webshop). Follow the instructions on the product packaging.

- Clean the filters in the wash cabinet regularly.

# Cleaning and care

---

## Cleaning the door and the door seal

The door seal and the sides of the dishwasher door are not accessed and cleaned by the spray arm jets.

- Wipe off any food or drink residues which may have dripped onto the sides and seals of the dishwasher door with a damp cloth on a regular basis to prevent the build-up of mould.

## Cleaning the control panel

- The control panel should **only** be wiped with a damp cloth.

## Cleaning the appliance front



Damage due to soiling.

Soiling that is left too long might become impossible to remove and could cause the external surfaces to alter or discolour.

Remove any soiling immediately.

- Clean the front with a soft sponge and a solution of warm water and a little washing-up liquid. After cleaning, wipe the front dry using a soft cloth.  
A clean, damp microfibre cloth (such as the Original Miele all purpose microfibre cloth) without detergent can also be used.

## To avoid damaging the external surfaces of the appliance, do not use:

- cleaning agents containing soda, ammonia, acid or chloride
- cleaning agents containing descaling agents
- abrasive cleaning agents, e.g. powder cleaners and cream cleaners
- solvent-based cleaning agents
- stainless steel cleaning agents
- dishwasher cleaners
- oven cleaners or sprays
- glass cleaning agents
- hard, abrasive brushes or sponges, e.g. pot scourers, brushes, or sponges which have been previously used with abrasive cleaning agents
- dirt eraser sponges
- sharp metal scrapers
- steel wool or metal scourers
- steam cleaners



## Cleaning the spray arms

Particles of food can get stuck in the spray arm jets and bearings. The spray arms should therefore be inspected regularly (approx. every 2–4 months).

**⚠** Damage due to soiling entering the circulation system.

Without filters, soiling can enter the circulation system and cause a blockage.

Do not run a wash programme without the lower spray arm or without the filters fitted.

When cleaning the filters and spray arms, make sure that coarse soiling cannot get into the circulation system.

- Switch the dishwasher off.

## Removing the upper and middle spray arms

- Take out the 3D MultiFlex tray (if present).
- Push the upper spray arm upwards to engage the inner ratchet. Then unscrew the spray arm by rotating the screw thread anti-clockwise (overhead perspective).

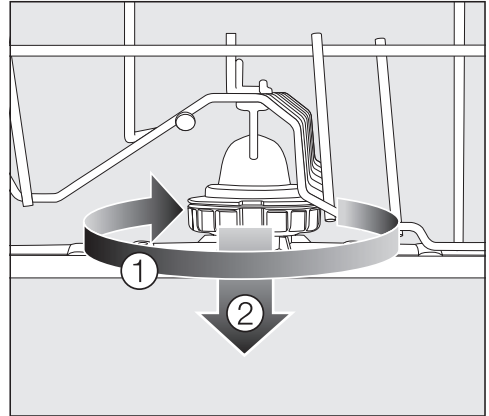

- Rotate the screw thread of the middle spray arm clockwise (overhead perspective) ① (see diagram) and remove the spray arm ②.

## Removing the lower spray arm

- Remove the lower basket.

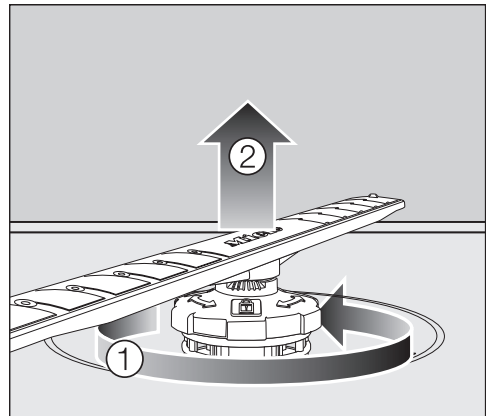

- Rotate the screw thread of the lower spray arm anti-clockwise ① and pull the spray arm upwards to remove ②.

# Cleaning and care

## Cleaning the spray arms

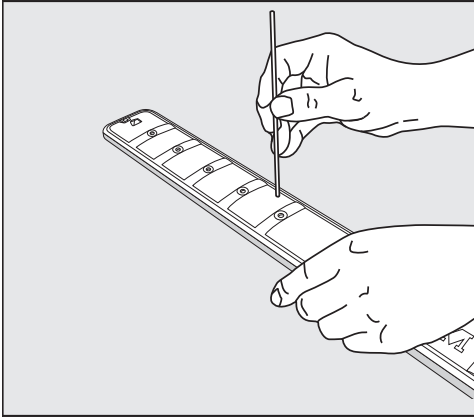



- Use a pointed object to push food particles stuck in the jets into the spray arm.
- Rinse the spray arm thoroughly under running water.

## Refitting the spray arms

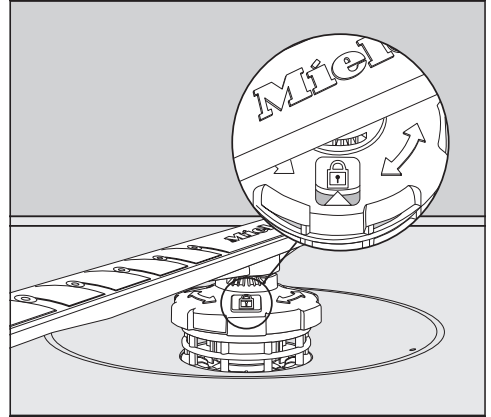
- Refit the upper and middle spray arms.
- Refit the lower spray arm and ensure that the filter combination lies flat in the base of the wash cabinet.



- Rotate the screw thread of the lower spray arm clockwise until the arrow in the viewing window points to the lock symbol .
- Make sure the spray arms can rotate freely.

 Damage due to soiling entering the circulation system.

The lower spray arm is used to secure the filter combination. Without filters, coarse soiling can enter the circulation system and cause a blockage.

Do not run a wash programme without the lower spray arm or without the filters fitted.

## Checking the filters in the wash cabinet

The filter combination in the base of the wash cabinet retains coarse soiling from the suds solution. This prevents soiling getting into the circulation system and re-entering the wash cabinet through the spray arms.

 **Damage due to soiling entering the circulation system.**

Without filters, soiling can enter the circulation system and cause a blockage.

Do not run a wash programme without the lower spray arm or without the filters fitted.

When cleaning the filters and spray arms, make sure that coarse soiling cannot get into the circulation system.

The filters can become clogged by soiling that collects over time. The level of soiling and the time it takes before the filters need cleaning will vary depending on use.

The message **Check filters** will appear in the display after every 50 programme sequences.

- Check the filter combination.
- Clean the filter combination if necessary.
- Then confirm the message with **OK**.

## Cleaning the filters

- Switch the dishwasher off.
- Remove the lower spray arm (see “Cleaning and care - Cleaning the spray arms”).
- Before removing the filter combination, remove any coarse soiling to prevent it from entering the circulation system.

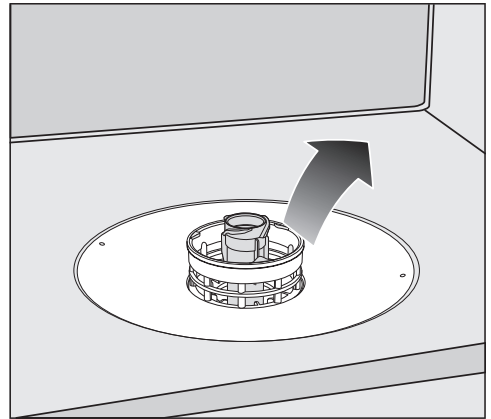

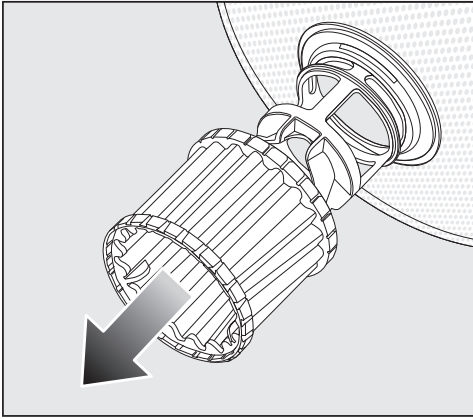

- Remove the filter combination.

## Cleaning and care

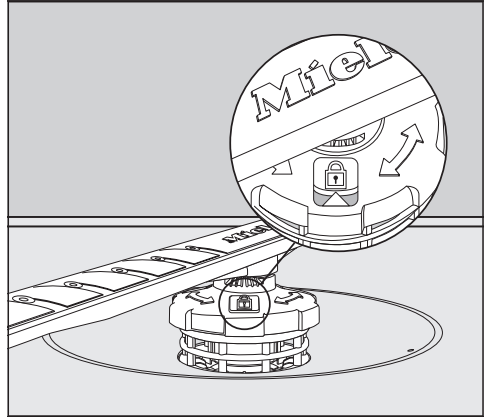

- In order to clean the inside of the filter, pull the microfilter by the plastic ring downwards and away from the filter combination.
- Rinse all the parts under running water.  
If necessary, use a soft cleaning brush to remove soiling.
- Push the microfilter back onto the filter combination.
- Refit the filter combination so that it lies flat in the base of the wash cabinet.
- Refit the lower spray arm to the filter combination using the screw thread.



- Rotate the screw thread clockwise until the arrow in the viewing window points to the lock symbol .

 Damage due to soiling entering the circulation system.

The lower spray arm is used to secure the filter combination. Without filters, coarse soiling can enter the circulation system and cause a blockage.

Do not run a wash programme without the lower spray arm or without the filters fitted.

### Cleaning the water inlet filter

A filter is incorporated in the screw thread to protect the water inlet valve. If the filter is soiled, insufficient water flows into the wash cabinet.

 Risk of electric shock.

The plastic housing of the water connection contains an electrical valve.

The housing must not be dipped in water.

- Disconnect the dishwasher from the mains power supply. To do this, switch off at the socket and withdraw the plug.
- Turn off the tap.
- Unscrew the water inlet valve.

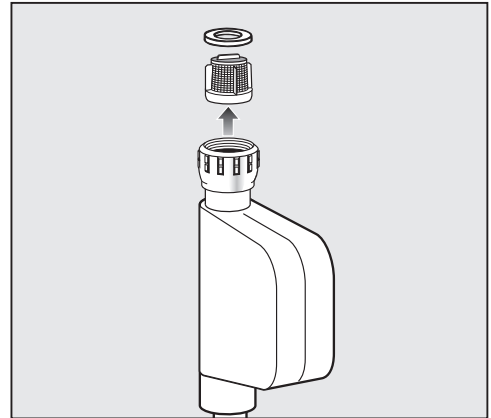

- Take the sealing washer out of the screw thread.
- Using combination or pointed pliers, take hold of the plastic filter bar and remove the filter.
- Rinse the filter under running water.
- Reassemble in reverse order.

Screw the threaded union securely back onto the tap. Slowly turn on the tap. If water drips out, tighten the connection.

**Never** forget to put the filter back in place after cleaning.

## Cleaning and care

---

### Cleaning the drain pump

If water remains in the wash cabinet after the end of a programme, the water has not been pumped away. The drain pump may be blocked by foreign objects. These foreign objects are easy to remove.

- Disconnect the dishwasher from the mains power supply. To do this, switch off at the socket and withdraw the plug.
- Take the filter combination out of the wash cabinet (see “Cleaning and care - Cleaning the filters”).
- Scoop the water out of the wash cabinet using a small container.

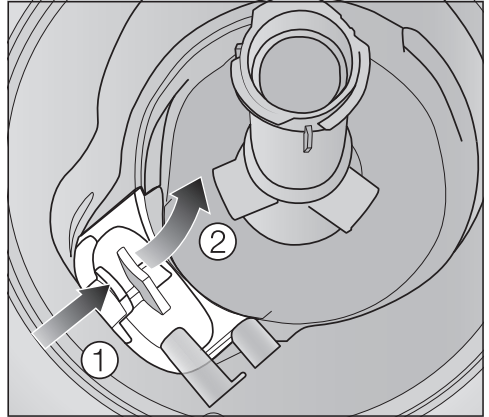

- Press the catch of the drain pump cover inwards ①.
- Tip the cover inwards until it is released ②.
- Rinse the cover thoroughly under running water and remove all foreign objects.

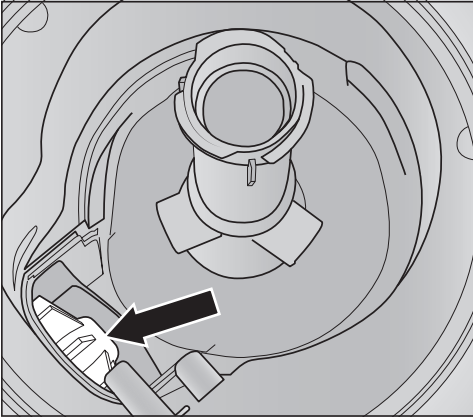

The drain pump (see arrow) is underneath the cover.

**!** Risk of injury from glass splinters.

It is especially difficult to see glass splinters in the drain pump. Take care when cleaning the drain pump.

- Carefully remove all foreign objects from the drain pump. Turn the drain pump impeller by hand to check that there are no more obstructions. You will feel a little resistance when you turn the impeller.
- Refit the cover in the reverse order of removing it.

Ensure that the catch engages correctly.

**!** Damage caused by incorrect cleaning.

The components are delicate and can be damaged during cleaning. Take care when cleaning the drain pump.

## Problem solving guide

---

With the help of the following guide, minor faults in the performance of the appliance, some of which may result from incorrect operation, can be remedied without contacting Miele. This will save you time and money because you will not need a service call.

Please note that a call-out charge will be applied to unnecessary service visits where the problem could have been rectified as described in these operating instructions. You should, however, note the following:



Danger due to incorrect repairs.

Unauthorised or incorrect repairs could cause personal injury or damage to the appliance.



Repairs must only be carried out by the Miele Professional Service Department, a Miele authorised service agent or a suitably qualified technician in accordance with local and national safety regulations.

### Technical problems

Problem	Possible cause and remedy
<b>The display remains dark after the dishwasher has been switched on with the  sensor.</b>	The dishwasher is not plugged in or the socket is not switched on. <ul style="list-style-type: none"><li>■ Insert the plug and switch on at the socket.</li></ul>
	The circuit breaker has tripped. <ul style="list-style-type: none"><li>■ Reset the circuit breaker in the mains fuse box (see data plate for minimum fuse rating).</li><li>■ If the circuit breaker trips again, call Miele.</li></ul>
<b>The dishwasher stops during a programme.</b>	The circuit breaker has tripped. <ul style="list-style-type: none"><li>■ Reset the circuit breaker in the mains fuse box (see data plate for minimum fuse rating).</li><li>■ If the circuit breaker trips again, call Miele.</li></ul>



## Fault messages

Problem	Possible cause and remedy
<p><b>The warning buzzer is sounding. One of the following faults appears in the display:</b></p>	<p>Before rectifying the problem, you must:</p> <ul style="list-style-type: none"> <li>■ Switch the dishwasher off.</li> </ul>
<p> Fault FXX</p>	<p>There may be a technical fault.</p> <ul style="list-style-type: none"> <li>■ Switch the dishwasher back on after a few seconds.</li> <li>■ Restart the desired programme.</li> </ul> <p>If the fault message appears again, there is a technical fault.</p> <ul style="list-style-type: none"> <li>■ Switch the dishwasher off.</li> <li>■ Turn off the tap.</li> <li>■ Call Miele.</li> </ul>
<p> Waterproof</p>	<p>The Waterproof system has reacted.</p> <ul style="list-style-type: none"> <li>■ Switch the dishwasher off.</li> <li>■ Turn off the tap.</li> <li>■ Call Miele.</li> </ul>
<p> Fault F78</p>	<p>Circulation pump fault.</p> <ul style="list-style-type: none"> <li>■ Switch the dishwasher off.</li> <li>■ Switch the dishwasher back on.</li> <li>■ Restart the desired programme.</li> </ul> <p>If the fault message appears again, there is a technical fault.</p> <ul style="list-style-type: none"> <li>■ Switch the dishwasher off.</li> <li>■ Turn off the tap.</li> <li>■ Call Miele.</li> </ul>



# Problem solving guide

---

## Door release

Problem	Possible cause and remedy
<b>The warning buzzer is sounding. The following fault is indicated in the display:</b>	Before rectifying the problem, you must: <ul style="list-style-type: none"><li>■ Switch the dishwasher off.</li></ul>
 Fault F33	<p>The door does not open automatically. There may be a technical fault.</p> <ul style="list-style-type: none"><li>■ Open the door manually (see “Using for the first time – Opening the door”) and switch the dishwasher back on.</li><li>■ If the same fault message appears again, call Miele.</li></ul> <p>The door locking pin does not retract after the door is opened. There may be a technical fault.</p> <ul style="list-style-type: none"><li>■ Switch the dishwasher back on.</li><li>■ If the same fault message appears again, call Miele.</li></ul>

## Water intake fault

Problem	Possible cause and remedy
<p><b>The warning buzzer is sounding.</b>  <b>One of the following messages appears in the display:</b></p>	
<p> Turn on tap</p>	<p>The tap is turned off.</p> <ul style="list-style-type: none"> <li>■ Turn on the tap fully.</li> </ul>
<p> Water intake</p>	<p>Before rectifying the problem, you must:</p> <ul style="list-style-type: none"> <li>■ Switch the dishwasher off.</li> </ul> <p>Water intake is restricted.</p> <ul style="list-style-type: none"> <li>■ Turn on the tap fully and start the programme again.</li> <li>■ Clean the filter in the water inlet (see “Cleaning and care – Cleaning the water inlet filter”).</li> <li>■ The water connection pressure is lower than 50 kPa. Seek professional advice.</li> <li>■ The on-site connection for the water drainage may be too low and you will need to raise the water drainage height (see “Installation – Hose position”).</li> </ul>
<p> Fault F18</p>	<p>A technical fault has occurred.</p> <ul style="list-style-type: none"> <li>■ Switch the dishwasher off.</li> <li>■ Turn off the tap.</li> <li>■ Call Miele.</li> </ul>

# Problem solving guide

---

## Water drainage fault

Problem	Possible cause and remedy
<p><b>The warning buzzer is sounding.</b></p> <p><b>The message  Drain appears in the display.</b></p>	<p>Before rectifying the problem, you must:</p> <ul style="list-style-type: none"><li>■ Switch the dishwasher off.</li></ul> <hr/> <p>Water drainage fault.</p> <p>There might be water in the wash cabinet.</p> <ul style="list-style-type: none"><li>■ Clean the filter combination (see “Cleaning and care – Cleaning the filters”).</li><li>■ Clean the drain pump (see “Cleaning and care – Cleaning the drain pump”).</li><li>■ Remove any kink or loop in the drain hose.</li></ul>

## General problems with the dishwasher

Problem	Possible cause and remedy
<b>The indicator lights and display are dark.</b>	The dishwasher has switched off automatically to save energy. <ul style="list-style-type: none"> <li>■ Switch the dishwasher back on using the  sensor.</li> </ul>
<b>The wash cabinet lighting does not come on when the door is opened.</b>	The wash cabinet lighting has been switched off permanently. <ul style="list-style-type: none"> <li>■ Switch the lighting back on (see “Settings - BrilliantLight”).</li> </ul>
	The wash cabinet lighting is faulty. <ul style="list-style-type: none"> <li>■ Call Miele.</li> </ul>
<b>Detergent residue is left in the detergent compartment at the end of a programme.</b>	The detergent compartment was still damp when detergent was added. <ul style="list-style-type: none"> <li>■ Only add the detergent when the detergent compartment is dry.</li> </ul>
<b>The detergent compartment lid cannot be closed.</b>	Residual detergent is blocking the catch. <ul style="list-style-type: none"> <li>■ Remove the residual detergent.</li> </ul>
<b>At the end of a programme there is a film of moisture on the inside of the door and possibly on the interior walls.</b>	This is part of the normal function of the drying system. The moisture will dissipate after a short while.
<b>Water remains in the wash cabinet at the end of a programme.</b>	Before rectifying the problem, you must: <ul style="list-style-type: none"> <li>■ Switch the dishwasher off.</li> </ul>
	The filter combination in the wash cabinet is clogged. <ul style="list-style-type: none"> <li>■ Clean the filter combination (see “Cleaning and care – Cleaning the filters”).</li> </ul>
	The drain pump is blocked. <ul style="list-style-type: none"> <li>■ Clean the drain pump (see “Cleaning and care – Cleaning the drain pump”).</li> </ul>
	The drain hose is kinked. <ul style="list-style-type: none"> <li>■ Remove any kinks from the drain hose.</li> </ul>

# Problem solving guide

---

## Noises

Problem	Possible cause and remedy
<b>Knocking noise in the wash cabinet.</b>	A spray arm is knocking against a crockery piece. ■ Carefully open the door and rearrange the wash items that are obstructing the spray arm.
<b>Rattling noise in the wash cabinet.</b>	Items of crockery are not secure in the wash cabinet. ■ Carefully open the door and rearrange the wash items so that they sit securely.
	There is a foreign object (e.g. glass shard) in the drain pump. ■ Remove the foreign object from the drain pump (see “Cleaning and care - Cleaning the drain pump”).
<b>Knocking noise in the water pipes</b>	This may be caused by the on-site installation or the cross-section of the piping. ■ However, this will not affect the functioning of the dishwasher in any way. If in doubt, contact a suitably qualified plumber.

## Unsatisfactory washing result

Problem	Possible cause and remedy
<p><b>The crockery is not clean.</b></p>	<p>The items were not loaded correctly.</p> <ul style="list-style-type: none"> <li>■ See notes under “Loading the dishwasher”.</li> </ul>
	<p>The programme was not thorough enough.</p> <ul style="list-style-type: none"> <li>■ Select a more intensive programme (see “Programme chart”).</li> </ul>
	<p>Not enough detergent was dispensed during manual detergent dispensing.</p> <ul style="list-style-type: none"> <li>■ Use more detergent, or change your detergent.</li> </ul>
	<p>Items are blocking the path of the spray arms.</p> <ul style="list-style-type: none"> <li>■ Carry out a rotation check and if needed rearrange the items so that the spray arms can rotate freely.</li> </ul>
	<p>The filter combination in the wash cabinet is not clean or was incorrectly installed. This may have caused the spray arm jets to become blocked.</p> <ul style="list-style-type: none"> <li>■ Clean and/or fit the filter combination correctly.</li> <li>■ Clean the spray arm jets if necessary (see “Cleaning and care - Cleaning the spray arms”).</li> </ul>
<p><b>There are smears on glassware and cutlery. There is a bluish sheen on the surface of glassware. The film can be wiped off.</b></p>	<p>The rinse aid dosage is set too high.</p> <ul style="list-style-type: none"> <li>■ Reduce the dosage (see “Settings - Rinse aid”).</li> </ul>

## Problem solving guide

Problem	Possible cause and remedy
<b>Dishes are not dry or cutlery and glasses are blotchy.</b>	The rinse aid dosage is set too low or the rinse aid reservoir is empty. ■ Replenish the rinse aid, increase the dosage, or change the brand of rinse aid (see “Using for the first time - Rinse aid”).
	Dishes were taken out of the wash cabinet too soon. ■ Leave dishes in longer (see “Operation - Unloading the dishwasher”).
	You have used combination products that have insufficient drying performance. ■ Switch to another detergent or add rinse aid (see “Using for the first time - Rinse aid”).
<b>Glassware has a brown or blue tinge. The film cannot be wiped off.</b>	Ingredients from the detergent have formed a deposit. ■ Switch to another detergent straight away.
<b>Glassware is dull and discoloured. The film cannot be wiped off.</b>	The glassware is not dishwasher safe. The surface has altered. ■ There is no remedy. Purchase glassware which is dishwasher safe.
<b>Tea or lipstick stains have not been completely removed.</b>	The wash temperature of the selected programme was too low. ■ Select a programme with a higher wash temperature.
	The bleaching effect of the detergent is too low. ■ Switch to another detergent.
<b>Plastic items are discoloured.</b>	Natural dyes, e.g. from carrots, tomatoes or tomato sauce may be the cause. The amount of detergent used or its bleaching effect was not sufficient to deal with natural dyes. ■ Use more detergent (see “Detergents”). Parts that are already discoloured will not revert to their original colour.



## Problem solving guide

Problem	Possible cause and remedy
<p><b>White residue is visible on the crockery. Clouding has occurred on glassware and cutlery. The film can be wiped off.</b></p>	<p>Not enough rinse aid was added.</p> <ul style="list-style-type: none"> <li>■ Increase the dosage (see “Settings – Rinse aid”).</li> </ul>
	<p>The salt reservoir is empty.</p> <ul style="list-style-type: none"> <li>■ Fill the salt reservoir (see “Using for the first time - Dishwasher salt”).</li> </ul>
	<p>The salt reservoir cap has not been screwed on correctly.</p> <ul style="list-style-type: none"> <li>■ Replace it, making sure that it screws back on correctly.</li> </ul>
	<p>Unsuitable combination detergents were used.</p> <ul style="list-style-type: none"> <li>■ Switch to another detergent. If using tabs or powder detergent, do not choose combination products and ensure you refill the reactivation salt and rinse aid.</li> </ul>
	<p>The water softener is programmed to a setting which is too low for the water hardness level.</p> <ul style="list-style-type: none"> <li>■ Programme the water softener to a higher water hardness level (see “Settings - Water hardness”).</li> </ul>
<p><b>There are rust stains on cutlery.</b></p>	<p>The affected items are not corrosion resistant.</p> <ul style="list-style-type: none"> <li>■ There is no remedy. Purchase cutlery which is dishwasher safe.</li> </ul>
	<p>A programme was not run after dishwasher salt was added. Traces of salt have got into the normal wash cycle.</p> <ul style="list-style-type: none"> <li>■ Always run the  <i>Cold pre-wash</i> programme without a wash load immediately after refilling salt.</li> </ul>
	<p>The salt reservoir cap has not been screwed on correctly.</p> <ul style="list-style-type: none"> <li>■ Replace it, making sure that it screws back on correctly.</li> </ul>

# After sales service

---

## Contact in case of fault

In the event of any faults which you cannot remedy yourself, please contact Miele.

You can book a Miele customer service call-out online at [www.miele.com/service](http://www.miele.com/service). Contact information for Miele can be found at the end of this booklet.

Please quote the model and serial number of your dishwasher when contacting Miele. These can be found on the data plate along the right edge of the open door.

The data plate is located on the right side of the door.

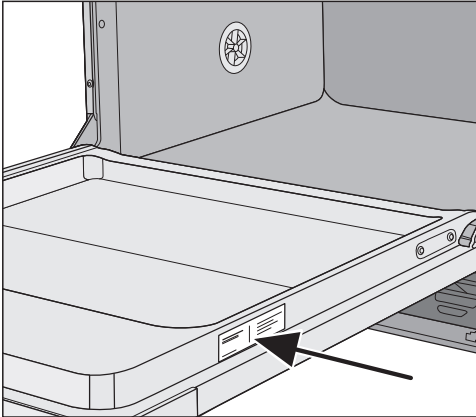

## Programme updates

The programme update function is designed to enable a service technician to update your dishwasher's electronics in keeping with advances in technology.

Programme updates can only be performed by a Miele service technician.

## Warranty

The manufacturer's warranty for this appliance is 1 year.

For further information, please refer to your warranty booklet.

## Electrical connection

 All work on the electrical connection must be carried out by the Miele Professional Service Department, a Miele authorised technician or a qualified electrician.

- The electrical installation must comply with current local and national safety regulations.
- The connection to the power supply must comply with national regulations (plug and socket must be accessible for service and maintenance work after the machine has been installed). An electrical safety test must be carried out after installation and after any service work.
- If the dishwasher is hard wired to the power supply, connection should be made via a mains switch with all-pole isolation. The mains switch must ensure a 3 mm gap between all open contacts, and must be able to be locked in the off position. The means for disconnection must be incorporated in the fixed wiring in accordance with the wiring rules.
- Equipotential bonding should be carried out if required.
- If replacing the mains connection cable, use only original Miele replacement parts or a suitable cable with **core cable ends**.
- For technical data see data plate or wiring diagram supplied.

The machine must only be operated with the voltage, frequency and fusing shown on the **data plate**.

This machine **can be converted to a different type of power supply** in accordance with the conversion diagram and wiring diagram supplied.

Converting the machine to a different type of power supply can lead to longer programme durations, resulting in increased energy consumption in some programmes. The values declared on the label will only be achieved if the machine remains in the state in which it was delivered.

The **data plates** are located at the back of the dishwasher and along the right edge of the open door.

The **wiring diagram** is supplied with the machine.

The **conversion diagram** is attached to the electrical connection plinth panel behind the plinth cover.

### Equipotential bonding connection

There is a screw connection point marked  at the back of the appliance, to which additional equipotential bonding can be connected.

# Installation

## The Miele Waterproof system

As long as your dishwasher has been installed correctly, the Miele Waterproof anti-leak system will protect you from water damage throughout its lifetime.

## Water intake

 Water in the dishwasher must not be used as drinking water.

- The machine must be connected to the water supply in strict accordance with current local and national requirements ( e.g. Plumbing Code of Australia (PCA)).
- The water used must at least comply with national regulations for drinking water quality.  
If the water supply has a high iron content, there is a danger of corrosion occurring on items being cleaned in the dishwasher, as well as the machine itself.  
If the chloride content of the water exceeds 100 mg/l, the risk of corrosion to items being cleaned in the dishwasher will be further increased.
- In certain regions (e.g. mountainous regions), the water composition may cause precipitates to form, requiring the use of softened water for the dishwasher.

- The water pressure (flow pressure at the connection point) must be between 50 and 1000 kPa (0.5 and 10 bar).

If the water pressure is lower than this, the fault message *Water intake* will appear in the display (see "Problem solving guide").

If the water pressure is too high, a pressure reducing valve must be fitted.

- A tap with a  $\frac{3}{4}$  inch male thread must be provided on site. It should be easily accessible so that the water supply can be turned off when the dishwasher is not in use.
- The DN 10 inlet hose is approx. 1.5 m long terminating in a  $\frac{3}{4}$  inch female thread. Under no circumstances must the inlet filter or the flow regulator in the connection be removed.

This appliance must be installed according to AS/NZS 3500.1 and AS/NZS 3500.2. This dishwasher has been supplied separately with a separate backflow prevention device (dual check valve).

The dual check valve supplied separately with this product must be installed between the tap and the water inlet hose. Screw the dual check valve onto the tap. Then screw the water inlet hose with the water protection system onto the thread of the dual check valve.

Turn on the the tap gradually to test for leaks. If there is a leak, the connection might not be on securely, or it may have been screwed on at an angle. Unscrew and reconnect the water correctly before tightening it.

⚠ To avoid any damage to the machine, the dishwasher must only be connected to a fully vented plumbing system.

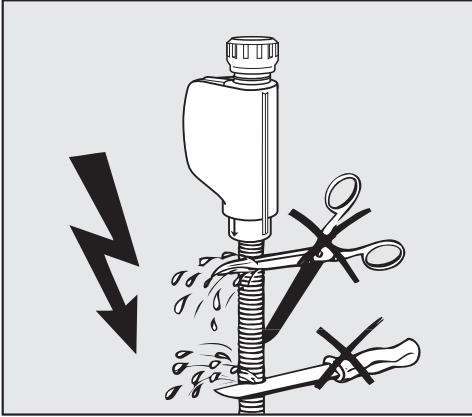

⚠ The inlet hose must **not** be shortened or damaged in any way as it contains electrical components (see illustration).

# Installation

---

## Connecting the drain hose

- The machine drainage system is fitted with a non-return valve, which prevents dirty water from flowing back into the dishwasher via the drain hose.
- The dishwasher drainage hose should preferably be connected to a separate on-site drain for the dishwasher only. If no separate connection is available, we recommend connecting it to a dual-chamber siphon.
- The dishwasher is supplied with approx. 1.5 m of flexible drain hose with an internal diameter of 22 mm. Hose clips are supplied with the dishwasher.
- The drain hose must not be shortened. The hose can be extended using a connection piece to attach a further length of hose. The drainage length must not be longer than 4 m and the delivery head no higher than 1 m.
- The drainage system must be able to accommodate a minimum drainage flow of 16 l/min.



Make sure that there are no kinks in the hose, and that it is not squashed or stretched.

## Hose positioning with a low water drainage height

If the on-site drainage connection is situated lower than the guide path for the lower basket rollers in the open door, the water drain hose must be raised to the height of the guide path for the lower basket rollers with a bend in it. Otherwise, a siphoning effect during a programme can cause the appliance to empty itself of water.

## Tall unit installation (only available in selected countries)

The accessories APFD 101 and APFD 102 are optional for installing the dishwasher in a tall unit.



# Technical data

<b>Dishwasher Model</b>	<b>Normal PFD 101, PFD 101i</b>	<b>XXL PFD 103 Sci</b>
Height of freestanding appliance	845 mm (adjustable + 35 mm)	-
Height of built-in appliance	805 mm (adjustable + 65 mm)	845 mm (adjustable + 65 mm)
Niche height	from 805 mm (adjustable + 65 mm)	from 845 mm (adjustable + 65 mm)
Width	598 mm	598 mm
Niche width	600 mm	600 mm
Depth of freestanding appliance	600 mm	-
Depth of built-in appliance	570 mm	570 mm
Weight	max. 60 kg	max. 52 kg
Voltage		
Rated load	See data plate	See data plate
Fuse rating		
Off mode (when On/Off is pressed)	0.29 W	0.28 W
End of cycle mode (steady state at end of cycle)	0.29 W	0.28 W
Delay start mode	0.25 W	0.23 W
Frequency band	2.4000–2.4835 GHz	2.4000–2.4835 GHz
Maximum transmission power	< 100 mW	< 100 mW
On-site water pressure	50 - 1.000 kPa	50 - 1.000 kPa
Cold or hot water supply	Up to max. 60 °C	Up to max. 60 °C
Mains water hardness	Max. 36 °dH	Max. 36 °dH
Delivery head	Max. 1.0 m	Max. 1.0 m
Drainage length	Max. 4.0 m	Max. 4.0 m
Ambient temperature	5 °C to 40 °C	5 °C to 40 °C
Relative humidity maximum	80 % for temperatures up to 31 °C	
linear decreasing to	50 % for temperatures up to 40 °C	
Mains connection cable	Approx. 2.4 m	Approx. 2.4 m
Capacity	14 standard place settings	15 standard place settings
Noise emission values		
Sound power in LwA	46 dB (A)	46 dB (A)
Sound pressure in LpA	34.1 dB (A)	32.5 dB (A)
Test certifications awarded	VDE, EMC radio and television suppressed	
Product safety standard	in accordance with AS/NZS 60335-1, AS/NZS 60335-2-5, AS/NZS 60335-2-58	
Manufacturer address	Miele & Cie. KG, Carl-Miele-Straße 29, 33332 Gütersloh, Germany	

You can alter the dishwasher's controls to suit changing requirements by adjusting the settings.

Settings can be altered at any time.

## Opening the Settings menu

- Switch the dishwasher on with the  sensor if it is switched off.
- Touch the  Settings sensor.

The first option in the Settings menu will appear in the display.

For further information about the display functionality, see "Guide to the appliance - Display functions".

## Changing settings

- Use the  $\vee/\wedge$  sensors to select the menu option you want to change and confirm your selection with *OK*.

Submenu options that have already been selected will have a tick  beside them.

- Select the setting you want using the  $\vee/\wedge$  sensors and confirm with *OK*.
- To exit a submenu, use the  Back sensor.



The display will revert to the menu above.



## Language

The display can be set to appear in one of several different languages.

You can change the language used in the display and also the country via the Language  submenu.

The flag after the word Language  serves as a guide if a language that you do not understand has been set. In this case keep selecting the menu option that has a flag after it until you reach the Language  submenu.

## Time of day

The current time of day must be set before you can use the timer option.

### Setting the clock format

You can select either a 24-hour or 12-hour clock.

- Select the Clock format menu option.
- Select the setting you want and confirm with *OK*.

### Setting the time of day

You can set the time of day.

- Select the Set menu option.
- Use the  $\vee/\wedge$  sensors to enter the hour and confirm your entry with *OK*. Then set the minutes and confirm with *OK*.

The time of day has now been saved.

## Water hardness

Your dishwasher is fitted with a water softener.

- The dishwasher needs to be programmed to the correct water hardness for your area.
- Your local water authority will be able to advise you of the water hardness level in your area.
- Where the water hardness fluctuates, e.g. between 1.8 and 2.7 mmol/l (10 - 15 °dH - German scale), always programme the dishwasher to the higher value (2.7 mmol/l or 15 °dH in this example).

If the water hardness in your area is available in a unit other than °dH, you can convert the values as follows:  
 $1\text{ °dH} = 0.18\text{ mmol/l} = 1.78\text{ °fH}$

°d	mmol/l	°f	Display
1	0.2	2	1
2	0.4	4	2
3	0.5	5	3
4	0.7	7	4
5	0.9	9	5
6	1.1	11	6
7	1.3	13	7
8	1.4	14	8
9	1.6	16	9
10	1.8	18	10
11	2.0	20	11
12	2.2	22	12
13	2.3	23	13
<b>14</b>	<b>2.5</b>	<b>25</b>	<b>14</b>
15	2.7	27	15
16	2.9	29	16
17	3.1	31	17
18	3.2	32	18
19	3.4	34	19
20	3.6	36	20
21	3.8	38	21
22	4.0	40	22
23	4.1	41	23
24	4.3	43	24
25	4.5	45	25
26	4.7	47	26
27	4.9	49	27
28	5.0	50	28
29	5.2	52	29
30	5.4	54	30
31	5.6	56	31
32	5.8	58	32
33	5.9	59	33
34	6.1	61	34
35	6.3	63	35
36	6.5	65	36

## Rinse aid

You can adjust the rinse aid dosage for best results.

The rinse aid dosage can be set from 0 to 6 ml.

3 ml is the factory default setting.

The rinse aid amount dispensed can turn out to be higher than the set value due to an automatic adjustment of the programme.

If spots appear on crockery and glassware:

- Increase the rinse aid dosage.

If clouding or smearing appears on crockery and glassware:

- Decrease the rinse aid dosage.

## External dispensing

Activate automatic dispensing of liquid detergent if you have installed the optional external dispensing module.

The DOS module is supplied with its own installation instructions.

- Select the setting you want and confirm with *OK*.

The setting will remain active until you deactivate "External dispensing".

## Detergent quantity

The following functions will only become visible when external dispensing has been activated.

A detergent amount of 0.50% is set as standard. The dispensed quantity can be modified between 0.1 and 2.00% in increments of 0.05%.

## DOS flow rate

A flow rate of 60 ml/min is set as standard. The flow rate can be modified between 10 and 150 ml/min in increments of 5 ml/min.

Set the dosage according to the cleaning agent manufacturer's recommendations.

- Choose the required detergent or flow rate quantities and confirm your selection with the *OK* button.

## Venting the dispensing system

The DOS system will not dispense reliably if there is air in the system.

The DOS system must be vented:

- when the DOS system is being used for the first time,
- if the liquid detergent reservoir was not refilled in time and the DOS system was emptied,
- if the detergent container was replaced.

 To ensure that the dispensing system functions properly, prior to venting make sure that the detergent container is full enough and that the dispensing lances are firmly attached to the containers.

- Select *Start venting* and confirm your entry with the *OK* sensor.

The venting process will begin.

Start the  "Cold pre-wash" programme directly after venting in order to dilute and drain any cleaning agent that has escaped into the wash cabinet.

## Temperature unit

The temperature can be shown in the display in degrees Celsius or degrees Fahrenheit.

- Select the setting you want and confirm your choice with the *OK* button.

## High temperature final rinse

For better drying, the rinse temperature can be increased for individual programmes. This function is not available for all programmes (see "Programme chart").

- Select the setting you want and confirm your choice with the *OK* button.

## Miele@home

Your dishwasher is equipped with an integrated Wi-Fi module.

You can connect your dishwasher to your Wi-Fi network.

This will increase the energy consumption, even when the dishwasher is switched off.

Additional menu options will be added to the “Settings” and “Miele@home” menus.

Make sure that your Wi-Fi network signal strength is strong enough at the installation site of your dishwasher.

There are a number of ways of connecting your dishwasher to your Wi-Fi network:

## Setting up Miele@home

You have the option of connecting your dishwasher to your network via WPS or the App

### Connect using WPS

You can connect your dishwasher to your Wi-Fi network via WPS (Wi-Fi Protected Setup).

Your Wi-Fi router must support WPS.

- Confirm the message *Press WPS button with OK*.
- Activate the WPS function on your router within two minutes.
- Once the connection has been established, confirm the message with *OK*.

If the connection fails, you have probably not connected WPS on your router quickly enough. Repeat the steps above.

## Connect using App

You can connect the dishwasher to the Miele@mobile App.

The App is available to download free of charge from the Apple App Store® or from the Google Play Store™.

## Miele@mobile App



- Select the **Connect using App** menu option and confirm with **OK**.
- Follow the instructions in the App.

Once the dishwasher is connected to your Wi-Fi network, you can use the App to carry out the following tasks:

- Call up information on the operating status of your dishwasher
- Call up information on the programme sequence of your dishwasher
- Set up a Miele@home network with other Wi-Fi enabled Miele appliances

## Activate

If you wish to connect your dishwasher to your Wi-Fi network, you can switch on the Wi-Fi module.

- Select the **Activate** menu option and confirm with **OK**.

In the Miele@home menu, the menu option **Deactivate** will now be displayed instead of **Activate**.

## Deactivate

If you do not wish to use the Wi-Fi module of your dishwasher, you can switch it off.

- Select the **Deactivate** menu option and confirm with **OK**.

In the Miele@home menu, the menu option **Activate** will now be displayed instead of **Deactivate**.

## Displaying Connection status

You can call up the current connection status of your dishwasher.

- Select the **Connection status** menu option and confirm with **OK**.
- Use the  $\vee/\wedge$  sensors to consecutively call up the Wi-Fi signal strength, the name of your router, and the associated IP address.
- Select **OK** to confirm the messages.

## Set up again

This menu option only appears if you have connected your dishwasher to your Wi-Fi network before.

## Connect using App

- Select the **Connect using App** menu option and confirm with **OK**.
- Follow the instructions in the App.

## Connect using WPS

- Select the **Connect using WPS** menu option and confirm with **OK**.
- Follow the instructions in the display.

## Network configuration

You can use this menu option to reset all Wi-Fi module settings (if available) to the factory default settings.

The network configuration should be reset whenever a dishwasher is being disposed of or sold, or if a used dishwasher is being put into operation. This is the only way to ensure that all personal data has been removed and, in the case of the latter, a previous owner will no longer be able to access the dishwasher.

## Remote control

This menu option will only be displayed if you have connected your dishwasher to your Wi-Fi network (see “Settings - Miele@home”).

If you wish to permanently switch off the **Remote control** option, you can do this under this menu option. The  sensor will then no longer be available to select until you change this setting again.

Even if the **Remote control** option is switched off, you can use the **Miele@mobile** App to call up information about your appliance. However, you cannot start any programmes or change any settings from it.

## RemoteUpdate

The RemoteUpdate menu option is only displayed and can only be selected if the requirements for using Miele@home have been met (see “Using for the first time - Miele@home”).

The RemoteUpdate function is used for updating the software in your dishwasher. If an update is available for your dishwasher, it will automatically download it. Updates will not be installed automatically. They must be initiated manually.

If you do not install an update, you can continue to use your dishwasher as usual. However, Miele recommends installing updates.

### Activating/Deactivating

The RemoteUpdate function is activated as standard. Available updates will be downloaded automatically but will only be installed if you initiate the installation manually.

Deactivate RemoteUpdate if you do not want any updates to be downloaded automatically.

## Running a RemoteUpdate

Information about the content and scope of a RemoteUpdate will be provided in the Miele@mobile App.

A message will appear in your dishwasher display if a software update is available.

You can install the update immediately or postpone this until later. When the appliance is switched on again, you will be reminded about the update.

Deactivate RemoteUpdate if you do not want to install the update.

The update may take several minutes.

Please note the following information about the RemoteUpdate function:

- You will only receive a message when an update is available.
- Once an update has been installed, it cannot be undone.
- Do not switch the dishwasher off during the update. Otherwise, the update will be aborted and will not be installed.
- Some software updates can only be carried out by a Miele service technician.



## SmartStart

This menu option will only be displayed if you have connected your dishwasher to your Wi-Fi network (see “Settings - Miele@home”).

The SmartStart function (only functional in selected countries) is used for starting your dishwasher automatically at a time when energy costs are most economical.

To use this function you may need further technical accessories.

If you have activated SmartStart Permitted, the Timer ⌚ menu of the selected programme will no longer show EcoStart but will instead show SmartStart. The dishwasher will then start within the timeframe specified when it receives a signal from the energy supplier.

If it has not received a signal from the energy supplier by the latest possible start time, the dishwasher will start automatically.

## EcoStart

In order to run your dishwasher in the most economical way, you can use the EcoStart option to take advantage of your electricity supplier’s cheaper energy tariffs (see “Options - Timer”). With this option selected, your dishwasher will start automatically at your electricity supplier’s cheapest rate times.

To use this option, you must first set up to three electricity rate tariff times in which the dishwasher can start. You can allocate different priorities to these tariff times. The time with the cheapest electricity rate will be given Priority 1.

Contact your energy supplier to find out the times of the cheapest electricity rates.

Once the electricity rate times have been set, you can use the EcoStart option to set the latest finish time required for each programme. The dishwasher will then start automatically during the cheapest energy rate time period. The programme will end at the set finish time at the latest.

## Setting the electricity rate times

Before you can use the EcoStart option, you must set at least one electricity tariff time.

- Use the  $\vee/\wedge$  sensors to select an electricity tariff time T1-T3 and confirm with *OK*.

The start of the electricity tariff time selected will appear in the display and the hour number block will be highlighted.

- Use the  $\vee/\wedge$  sensors to set the hour and minutes for the start time and confirm both with *OK*.

The end of the electricity tariff time selected will appear in the display and the hour number block will be highlighted.

- Use the  $\vee/\wedge$  sensors to set the hour and minutes for the finish time and confirm both with *OK*.

The electricity tariff time will be saved and its priority will appear in the display.

- Use the  $\vee/\wedge$  sensors to set the priority you want and confirm with *OK*.
- Confirm the message with *OK*.

The electricity rate time will be activated.

## Changing the electricity tariff times

You can change the start, finish, or priority of an electricity tariff time.

- Use the  $\vee/\wedge$  sensors to select an electricity tariff time T1-T3 that you wish to change and confirm with *OK*.
- Select the setting you want to change and confirm with *OK*.
- Use the  $\vee/\wedge$  sensors to change the setting and confirm with *OK*.
- Confirm the message with *OK*.

The change will be saved.

## Deleting the electricity tariff times

You can delete the settings for an energy tariff time and in doing so deactivate the *EcoStart* option for this time zone.

- Use the  $\vee/\wedge$  sensors to select an electricity tariff time T1-T3 that you wish to delete and confirm with *OK*.
- For example, select *Delete T1* and confirm with *OK*.
- For example, select *Delete T1?* and confirm with *OK*.

The settings for the electricity tariff time selected will be reset.

- Confirm the message with *OK*.

The energy tariff time will be deleted.

## Consumption (EcoFeedback)

You can set whether the energy and water consumption is displayed for the selected programme. This function shows the estimated consumption before a programme, and the actual consumption after the end of the programme.

In this menu you can also call up the total consumption of water for all the wash programmes you have run on your dishwasher to date (see “Caring for the environment - EcoFeedback consumption display”).

### Displaying Consumption

- Select the *Consumption display* menu option and confirm with *OK*.
- Select the setting you want and confirm with *OK*.

### Displaying Total consumption

- Select the *Total consumption* menu option and confirm with *OK*.
- The *Water* menu option displays the total consumption.

You can also reset the value for the total consumption to 0.

- Select the *Reset* menu option and confirm with *OK*.
- Select the *Yes* menu option and confirm with *OK*.
- Confirm the message with *OK*.

The values are now reset to 0.

## Display brightness

You can set the display brightness to one of seven different levels.

## Volume

A sequence of warning tones will sound at the end of the programme or if there is a fault, provided that the signal tones are activated.

### Signal tones in the event of a fault

In the event of a fault, the alarm tone will sound four times at intervals with a short pause between each set of tones.

The alarm tone that sounds when there is a fault cannot be deactivated.

### Signal tones

The signal tones at the end of a programme will sound four times at intervals with a short pause between each tone.

The volume of the signal tones at the end of the programme can be set to one of seven different settings. If no volume is selected, the signal tones are switched off.

### Keypad tone

An audible tone sounds each time a sensor is pressed.

The volume for the keypad tone can be set to one of seven different settings. If no volume is selected, the keypad tone is switched off (except for the  *On/Off* sensor).

### Welcome melody

When you switch the dishwasher on or off, a brief melody sounds.

You can switch this melody off.

## Refill reminders

If you only ever use combination detergent products or automatic dispensing using Miele PowerDisks (if available), you can switch off the refill reminders for reactivation salt and rinse aid if you wish.

Please make sure that if you stop using combination detergents, you refill the dishwasher salt and rinse aid. Switch the refill reminders back on.

## AutoOpen

In some programmes the door automatically opens slightly to assist the drying process.

This function can be deactivated if you wish.

 Risk of damage due to steam. Steam from the dishwasher could damage the edges of delicate worktops when you open the door at the end of the programme if the fan is no longer running. If you have deactivated the automatic door opening function but would still like to open the door at the end of the programme, make sure that you open the door fully.

## BrilliantLight

This dishwasher is equipped with wash cabinet interior lighting.

When the door is open, the lighting switches off automatically after 15 minutes.

You can also switch off the wash cabinet interior lighting permanently.

## Software version

You can display the electronic software version of your dishwasher electronics for technical support purposes.

## Showroom

For demonstration purposes only.

The dishwasher is equipped with a Demo mode for showroom use.

## Factory default

You can reset all the appliance settings to the factory default settings.

The settings of the Wi-Fi module (where applicable) have to be reset separately (see "Settings – Miele@home – Reset").

## Appliance settings

You can use this menu option to reset all dishwasher settings, except Wi-Fi module settings, to the factory default settings.





**Miele**

**Miele Australia Pty. Ltd.**

ACN 005 635 398

ABN 96 005 635 398

**Melbourne:**

Level 4, 141 Camberwell Road

Hawthorn East, VIC 3123

Telephone: 1300 731 411

[service.prof@miele.com.au](mailto:service.prof@miele.com.au)

**[www.miele.com.au/professional](http://www.miele.com.au/professional)  
[sales@miele-professional.com.au](mailto:sales@miele-professional.com.au)**

**Miele New Zealand Limited**

IRD 98 463 631

8 College Hill

Freemans Bay

Auckland 1011

New Zealand

Telephone: 0800 4 MIELE

(0800 464 353)

[www.miele.com.au/professional](http://www.miele.com.au/professional)

[sales@miele-professional.com.au](mailto:sales@miele-professional.com.au)



Miele Global Headquarters: Miele & Cie. KG  
Carl-Miele-Straße 29, 33332 Gütersloh, Germany