

linarie

# HUEZ

• LK90TTBG •

REFRIGERATOR

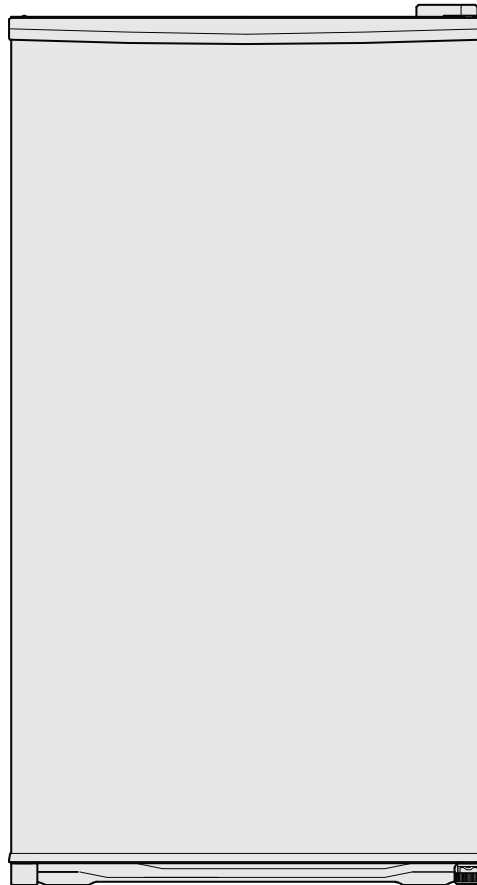

**EN** Operation, Installation  
& Instruction Manual

[www.linarie.com.au](http://www.linarie.com.au)

Register  
your  
product  
online

# CONGRATULATIONS

Congratulations and thank you for choosing Linärie to introduce a new comfort of cooking in your home. We are sure you will find your new appliance a pleasure to use and a great asset to your kitchen.

This appliance complies with all relevant safety requirements in Australia. Inappropriate use can, however, lead to personal injury and damage to property.

In order to operate the unit correctly and safely, please read this instruction manual carefully before installation and usage. This user manual which provides you with all required instructions related to safety, installation, use and maintenance of the appliance.

For future reference, please store this booklet in a safe place and ensure that all users are familiar with the contents. Pass them on to any future owner of the appliance.

Record Model & Serial Number

Model:.....

Serial Number .....

Register your product [www.linarie.com.au](http://www.linarie.com.au)

## IMPORTANT

Adherence to the directions for use in this manual is extremely important for health and safety. Failure to strictly adhere to the requirements in this manual may result in personal injury, property damage and affect your ability to make a claim under Linärie's manufacturer's warranty provided with your product. Products must be used, installed and operated in accordance with this manual. You may not be able to claim on Linärie's manufacturer's warranty in the event that your product fault is due to failure to adhere this manual.

### Correct Conditions of Use

- The appliance is intended for use in the home and similar environments only. It is not intended for commercial use.
- The appliance is not suitable for outdoor use, non-stationary installation.
- This product is use in storing and keeping your food and drinks safe and fresh.

 The electricity connection must be made by a qualified specialist. Installation must comply with the valid standards, regulations and laws. All safety and warning information and the operating and installation instructions must be complied with.

## TABLE OF CONTENTS

<b>1. General Information</b> .....	03	<b>9. Defrosting</b> .....	08
1.1 Appliance information		<b>10. Helpful hints and tips</b> .....	08
<b>2. General Safety Instructions</b> .....	03	<b>11. Cleaning and care</b> .....	09
2.1 General safety information		<b>12. Door reverse</b> .....	09
2.2 Safety instruction - Installation		<b>13. Troubleshooting</b> .....	10
2.3 Correction use & Operation .....	04	<b>14. Environmental tips</b> .....	11
2.4 Disassembling and Disposal of the Appliance		14.1 Disposal considerations	
2.5 Accessories and Spare parts		14.2 Disposing your old appliance	
<b>3. Technical data sheet</b> .....	05	<b>15. Warranty and After sales</b> .....	11
<b>4. Structure illustration</b> .....	05	15.1 Warranty	
<b>5. Transport and handing</b> .....	05	15.2 After sales service	
<b>6. Installation</b> .....	06	15.3 Replacement of spare parts	
<b>7. Operation</b> .....	06		
7.1 First use			
7.2 Testing			
7.3 Temperature control			
<b>8. Storage of food</b> .....	07		

Additional information on products, accessories, warranty, replacement parts and services can be found at [www.linarie.com.au](http://www.linarie.com.au)

# 1. GENERAL INFORMATION

## 1.1 Appliance Information

- A damaged appliance can be dangerous. If you find the appliance is damaged or marked, you must report it within 7 days if you wish to claim for damage/marks under the manufacturer's warranty. This does not affect your statutory rights. Do not use a damaged appliance.
- The manufacturer's warranty will be invalidated if the appliance is not repaired by a Linärie approved service technician.
- Faulty components must only be replaced by genuine Linärie spare parts. The manufacturer can only guarantee the safety of the appliance when Linärie replacement parts are used.
- If the power cord is damaged, it must only be replaced by a Linärie authorized service technician or suitably qualified electrician in order to avoid a hazard.
- Linärie cannot be held liable for noncompliance with these instructions, resulting from incorrect or improper use or operation.

# 2. GENERAL SAFETY INSTRUCTIONS

 The appliance complies with the stipulated safety requirements in Australia. The user is responsible for appliance cleaning and maintenance as well as its safe use. Improper use can lead to personal injury and damage to property.

## 2.1 General Safety Instructions

### Children and People with Special Needs

#### WARNING

This appliance is not intended for use by persons (including children) with reduced physical, sensory or mental capabilities, or lack of experience and knowledge, unless they have been given supervision or instruction concerning use of the appliance by a person responsible for their safety.

- The appliance is NOT suitable for use by children without supervision.
- Young children should be supervised near the appliance to ensure they do not play with this appliance.
- Children may be able to wrap themselves in packing material or pull it over their heads with the risk of suffocation. Keep children away from any packing material.

### Unauthorized Modifications

Unauthorised modifications can cause the appliance to pose risks. Do not conduct any modifications to the appliance.

### Cleaning & Maintenance

The device must be cleaned regularly. Dirt can lead to damage or the buildup of odors. (See "Cleaning and maintenance" section).

- Always clean the appliance exactly as indicated in the operating instructions.
- Always ensure the appliance is switched off before cleaning or replacing parts.
- Clean the appliance immediately after any food spillage and the filter regularly to keep the appliance working efficiently.
- There is a risk of fire if cleaning is not carried out as described in these operating instructions.
- Make sure no water penetrates inside the device when cleaning. Do not use a steam cleaning appliance to clean this appliance. The steam could reach electrical components and cause a short circuit.
- In areas which may be subject to infestation by cockroaches or other vermin, pay particular attention to keeping the machine and its surroundings in a clean condition at all times. Any damage which may be caused by cockroaches or other vermin will not be covered by the machine warranty.

## 2.2 Safety Instructions - Installation

#### WARNING

The appliance must only be installed and assembled by trained specialists who are familiar with and comply with the standard national regulations and supplementary regulations of ventilation systems.

- In order to avoid any potential hazard, the installation instructions must be followed.
- Observe all regional regulations for the installation of ventilation systems.
- During installation, maintenance and repair work, the appliance must be disconnected from the mains electricity supply. It is only completely isolated from the electricity supply when:
  - the mains circuit breaker is switched off, or
  - it is switched off at the wall socket and the plug is withdrawn from the socket.
- Do not pull the mains connection cable but the mains plug to disconnect your appliance from the mains electricity supply.
- Do not connect the appliance to the mains electricity supply by a multi-socket unit or an extension lead.
- Extension leads are a fire hazard and do not guarantee the required safety of the appliance.
- Tampering with electrical connections or components and mechanical parts is highly dangerous to the user and can cause operational faults. Only open the housing as described in the instructions given in "Installation" and in the "Cleaning & Maintenance" sections of this booklet. Under no circumstances should any other parts of the housing be opened.

- THIS APPLIANCE MUST BE PROPERLY EARTHED. It is most important that this basic safety requirement is present and tested regularly and, where there is any doubt, the household wiring system should be inspected

by a qualified electrician. Linärie cannot be held liable for noncompliance with these instructions, resulting from incorrect or improper use or operation.

- Due to the special characteristics of the tempered glass, the tempered glass may be exploded at the probability rate of 3‰- 5‰ according to the industrial estimate, while this company will strictly control it within 3‰.

- Regarding the information pertaining to the installation, handing, maintenance, servicing and disposal of the appliance, thanks to refer to the paragraph "TRANSPORT AND HANDING" "INSTALLATION" "CLEANING AND CARE" "TROUBLESHOOTING" of the manual.

## 2.3 Correct use and Operation

- For safety reasons, this appliance may only be used after it has been built in.
- Reliable and safe operation of this appliance can only be assured if it has been connected to the mains electricity supply.
- Before using the appliance, ensure that all packaging materials are removed from the appliance and make sure that the connection data on the data plate [voltage (V) and frequency (Hz)] indicated on the appliance corresponds to the voltage and frequency of the power supply in your household. Consult a qualified electrician if in doubt.
- DO NOT store or spray flammable materials in the appliance or near this appliance while it is in operation (e.g. aerosols).
- Cracks, fissures or fractures in the glass ceramic panels can damage the underlying electronics. Switch off and disconnect the appliance immediately.

- Prevent water ingress. Never sprinkle or flush the cooler using water, nor place the cooler in an area exposed to moisture or water sprinkling, let alone filling the cooler with water, so as to avoid impairment of the electric insulativity of the cooler. Furthermore, failing to follow such requirements may lead to electric shock and fire, or other accidents.
- After the cooler is put into operation, never touch its inner icing surface, especially when your hand is wet; otherwise the skin may stick onto the inner surface to get injured.
- Opening the door for long periods can cause a significant increase of the temperature in the compartments of the appliance.
- Clean regularly surfaces that can come in contact with food and accessible drainage systems. If the refrigerating appliance is left empty for long periods, switch off, defrost, clean, dry, and leave the door open to prevent mould developing within the appliance.

### WARNIN G

The refrigerant isobutane (R600a) is contained within the refrigerant circuit of the appliance, a natural gas with a high level of environmental compatibility, which is nevertheless flammable. During transportation and installation of the appliance, ensure that none of the components of the refrigerant circuit becomes damaged.

## 2.4 Disassembling and Disposal of the Appliance

(see the "Environmental Tips" section for best practices on disposing of this appliance).

The device must only be disassembled by trained specialists who are familiar with and comply with the standard national regulations and supplementary regulations of the local utility companies.

Work on electrical components must only be conducted by trained electrical personnel.

## 2.5 Accessories and Spare parts

Incorrect components can lead to personal injury or damage to the appliance. Only use original Linärie spare parts for repairs.

Modifications, additions or alterations to the appliance can lead to safety risks. If spare parts or accessories from other manufacturers are used, the warranty will be invalidated, and Linärie cannot accept liability.

Please check [www.linarie.com.au](http://www.linarie.com.au) for more information.

### 3. TECHNICAL DATA SHEET

Reference:	LK90TTBG
Rated voltage:	220-240V~
Ampere:	2.0A
Rated frequency:	50Hz
Lamp power:	MAX 10W

Climate class:	N/ST
Refrigerant:	R600a(83g)
Protection against electrical shock:	Protection against electrical shock:
Insulation foam:	Cyclopentane

### 4. STRUCTURE ILLUSTRATION

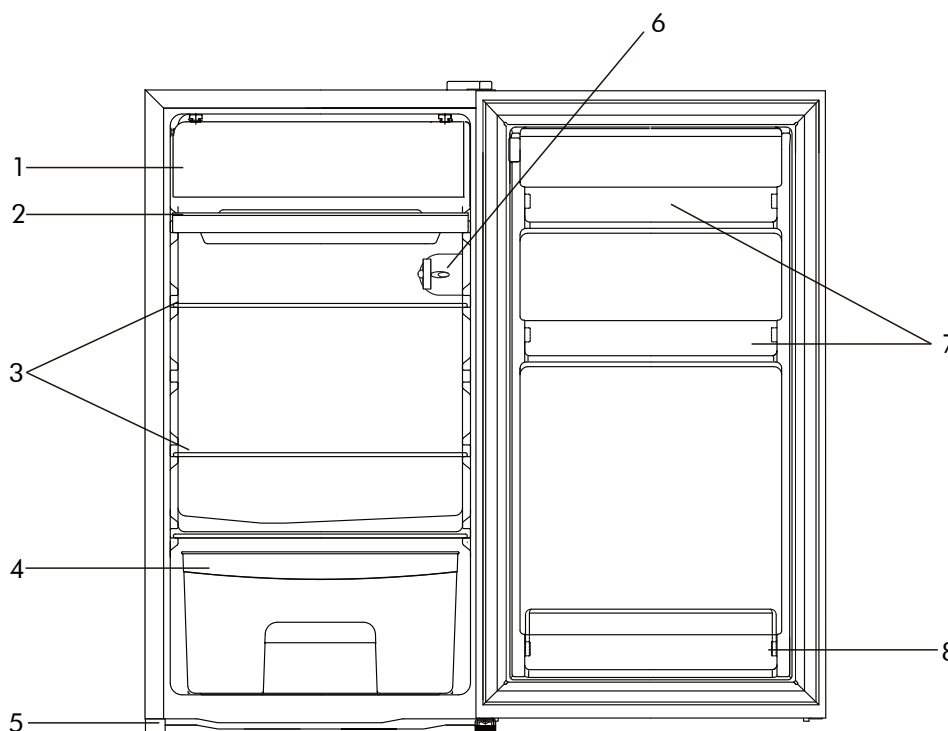

- 1. Fresh room
- 2. Drip Tray
- 3. Glass shelf
- 4. Crisper

- 5. Adjustable foot
- 6. Thermostat Knob
- 7. Balcony
- 8. Bottle rack

#### Climate class

- Extended temperate(SN): 'this refrigerating appliance is intended to be used at ambient temperatures ranging from 10 °C to 32 °C';
- Temperate(N): 'this refrigerating appliance is intended to be used at ambient temperatures ranging from 16 °C to 32 °C';

- Subtropical(ST): 'this refrigerating appliance is intended to be used at ambient temperatures ranging from 16 °C to 38 °C';
- Tropical(T): 'this refrigerating appliance is intended to be used at ambient temperatures ranging from 16 °C to 43 °C';

**Note:**

More data information, please scan the QR code on the energy label.

### 5. TRANSPORT AND HANDING

When transportation, hold the base and lift the refrigerator carefully with an angle inferior at 45 degree. Never hold the door handle as support. Never place it upside down nor horizontally. Push refrigerator on its basis and place it thanks to its roller feet.

## 6. INSTALLATION

- This refrigerating appliance is not intended to be used as a built-in appliance.
- To fix stably, the appliance must be placed on a flat and solid surface. It should not be laid on any soft material.
- Choose a location where there is no heat source. Keep the refrigerator away from direct sunlight or other appliance producing heat.
- Choose a dry and well-ventilated place where there is no corrosive air.
- In order to improve efficiency of the cooling system and save energy, it is necessary to maintain good ventilation around the appliance for the dissipation of heat. For this reason, sufficient clear space should be available around the refrigerator.
- The appliance is supplied with two plastic spacers. After installation of these spacers, the appliance cannot be pushed against the wall to maintain proper ventilation. Insert the spacers into the relevant openings on the back of the appliance, then screw the spacers tightly. Place the appliance against a wall with a free distance that not exceeding 75 mm but more than 50mm.

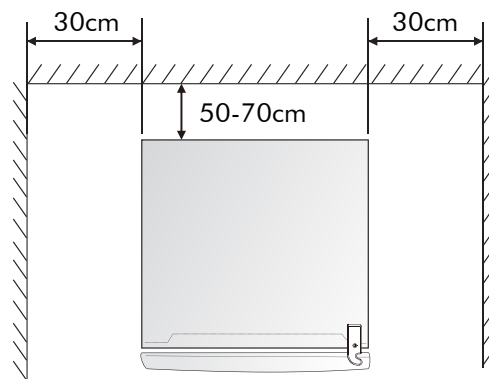
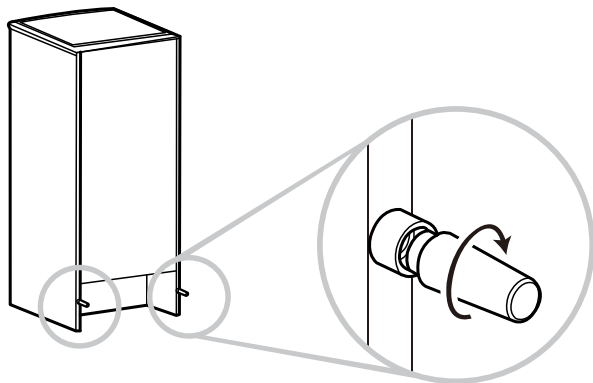

## 7. OPERATION

### 7.1 First use

- Before the use of the refrigerator, remove all the packages, including bottom cushion and foam pads and rubber belts in the refrigerator.
- Adjust the feet and clear the outside and inside of the refrigerator with warm cloth.
- Do not start the refrigerator immediately after vertical placement. Only start it after 2-6 hours standing to ensure its proper operation.
- To prevent damage to the power cord and any consequence incidents, the power cord should be not covered by the refrigerator or other objects. Before switching on the refrigerator, please check the voltage range of refrigerator carefully if the same as that of the power supply.
- When the refrigerator is first installed, allow it stabilize at normal operating temperatures for 2-3 hours prior to filling it with fresh or frozen foods.
- If operation is interrupted, wait for 5 minutes before restarting.

### 7.3 Temperature control

The fridge is controlled with a temperature control knob located inside it, towards the upper right-hand corner. Adjust the control knob as desired to suit your individual preference.

0=off setting  
1=cold setting  
7=coldest setting

- In the off position (0) the appliance does not operate (the cooling system is switched off), but power supply is not interrupted.
- The running time and temperature are affected by where the fridge is located, how often the door is opened and the temperature of the room the fridge is located in.

### 7.2 Testing

- Clean the parts of the refrigerator with lukewarm water on a soft cloth or with a neutral detergent and with clear water, then wipe them dry.  
**Notes:** Electric parts of the refrigerator can only be wiped by dry cloth.
- Turn the thermostat knob on the "3" position and turn on electricity. The compressor and the light inside the refrigerator begin to work.
- Close the door and wait 30 minutes. If the temperature in the freezer compartment decreased obviously, it shows that the refrigerator system works well. When the refrigerator operates for a period of time, the temperature controller will automatically set the temperature on conditions that the door is not too often opened.
- If the above steps are successful, the trial operations are finished. The refrigerator works normally.

- When you use the appliance for the first time or after defrosting, adjust the control knob to the coldest setting for at least 2 hours before introducing food to be stored, and then readjust to the middle setting.  
Set the thermostat knob to "3-4" position for a normal use.

#### **Note:**

The temperature will impact the storage time of food. Set the temperature as necessary. Warmer will accelerate food spoilage and colder will frozen food bad. Thus food to be wasted.

## 8. STORAGE OF FOOD

- Your appliance has the accessories as the "Structure illustration" showed in general, with this part instruction you can have the right way to storage your food.
- The glass shelves and crisper can be removed to store food if needed.

### Note:

Food is not allowed to touch directly all surfaces inside the appliance. It has to be wrapped separately in aluminum sheet or in cellophane sheet or in airtight plastic boxes.

### Storing food in the refrigerator compartment

The fridge freezer compartment helps to extend the storage times of fresh perishable foods.

Fresh food care for best results:

- Store foods that are very fresh and of good quality.
- Ensure that food is well wrapped or covered before it is stored. This will prevent food from dehydrating, deteriorating in colour or losing taste and will help maintain freshness. It will also prevent odour transfer.
- Vegetables and fruit need not be wrapped if they are stored in the vegetable container of the fridge compartment.
- Make sure that strong smelling foods are wrapped or covered and stored away from foods such as butter, milk and cream which can be tainted by strong odours.
- Cool hot foods down before placing them in the fridge compartment.

### Dairy foods and eggs

- Most pre-packed dairy foods have a recommended 'use by /best before/best by/' date stamped on them. Store them in the fridge compartment and use within the recommended time.
- Butter can become tainted by strong smelling foods so it is best stored in a sealed container.
- Eggs should be stored in the fridge compartment.

### Red meat

- Place fresh red meat on a plate and loosely cover with waxed paper, plastic wrap or foil. Store cooked and raw meat on separate plates.
- This will prevent any juice lost from the raw meat from contaminating the cooked product.

### Purchasing frozen food

- Packaging must not be damaged.
- Use by the 'use by /best before/best by/' date.
- If possible, transport deep-frozen food in an insulated bag and place quickly in the freezer compartment.

### Storing frozen food

- Store at -18°C or colder. Avoid opening the freezer compartment door unnecessarily.

### Freezing and storing food in the freezer compartment

- To store deep-frozen food.
- To make ice cubes.
- To freeze food.

### Note:

Ensure that the freezer compartment door has been closed properly.

### Never forget:

- When you freeze fresh foods with a 'use by /best before/best by/date, you must freeze them before this date expires.
- Check that the food was not already frozen. Indeed, frozen food that has thawed completely must not be re-frozen.
- Once defrosted, food should be consumed quickly.

### Poultry

- Fresh whole birds should be rinsed inside and out with cold running water, dried and placed on a plate. Cover loosely with plastic wrap or foil.
- Poultry pieces should also be stored this way. Whole poultry should never be stuffed until just before cooking, otherwise food poisoning may result.

### Precooked foods and leftovers

- These should be stored in suitable covered containers so that the food will not dry out.
- Keep for only 1-2 days.
- Reheat leftovers only once and until steaming hot.

### Vegetable container

- The vegetable container is the optimum storage location for fresh fruit and vegetables.
- Take care not to store the following at temperatures of less than 7°C for long periods: Citrus fruit, melons, pineapple, papaya, cures, passion fruit, cucumber, peppers, tomatoes.
- Undesirable changes will occur at low temperatures such as softening of the flesh, browning and/or accelerated decaying.
- Do not refrigerate avocados (until they are ripe), bananas and mangoes.

Food	Location
Butter, cheese	Upper door rack
Eggs	Door rack
Fruit, vegetables, salad	Crisper
Meat, sausage, cheese, milk	Lower area (lowest shelf / crisper cover)
Dairy products, canned food, cans	Upper area/ door rack
Drinks, bottles, tubes	Door rack

### Freezing fresh food

- Freeze fresh and undamaged food only.
- To retain the best possible nutritional value, flavour and colour, vegetables should be blanched before freezing. Aubergines, peppers, zucchini and asparagus do not require blanching.

### Note:

Keep food to be frozen away from food which is already frozen.

### The following foods are suitable for freezing:

Cakes and pastries, fish and seafood, meat, game, poultry, vegetables, fruit, herbs, eggs without shells, dairy products such as cheese and butter, ready meals and leftovers such as soups, stews, cooked meat and fish, potato dishes, soufflés and desserts.

### The following foods are NOT suitable for freezing:

Types of vegetables, which are usually consumed raw, such as lettuce or radishes, eggs in shells, grapes, whole apples, pears and peaches, hard-boiled eggs, yoghurt, soured milk, sour cream, and mayonnaise.

### Packing frozen food

To prevent food from losing its flavor or drying out, place food in airtight packaging.

- Place food in packaging.
- Remove air.
- Seal the wrapping.
- Label packaging with contents and dates of freezing.

### Suitable packaging:

Plastic film, tubular film made of polyethylene, aluminum foil. These products are available from specialist outlets.



## 9. DEFROSTING

Defrost the refrigerator when the frost is more than 3mm thick. To defrost, simply press the defrost button on the temperature control knob.

Be sure to keep the drip tray in place.

The refrigerator will restart automatically when defrosting ends. Empty water from the drip tray after defrosting.

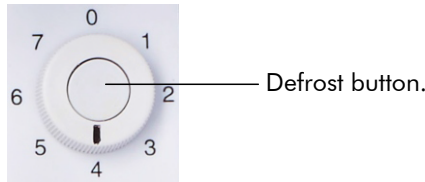

- /best by/' date, you must freeze them before this date expires. Check that the food was not already frozen. Indeed, frozen food that has thawed completely must not be re-frozen. Once defrosted, food should be consumed quickly.

### Defrosting the freezer compartment

The freezer compartment does not defrost automatically, otherwise the frozen food would start thawing. A layer of frost in the freezer compartment impairs refrigeration of the frozen food and increases power consumption. Remove the layer of hoarfrost regularly.

**WARNING:** Do not scrape off hoarfrost or ice with a knife or pointed object. Doing this may damage the refrigerant tubes.

1. Remove the frozen food and place temporarily in a cool location.
2. Set the temperature control knob to the 0 position and disconnect the mains plug from the mains socket.
3. To accelerate the defrosting process, place a pan of hot water on a stand in the freezer compartment.
4. Wipe up condensation with a cloth or sponge.
5. Wipe dry the freezer compartment.
6. Plug in the appliance and adjust the temperature control knob as desired.
7. Put the frozen food back in the freezer compartment.

## 10. HELPFUL HINTS AND TIPS

**We recommend that you follow the tips below to save energy.**

- Try to avoid keeping the door open for long periods in order to conserve energy.
- Ensure the appliance is away from any sources of heat (Direct sunlight, electric oven or cooker etc)
- Don't set the temperature colder than necessary.
- Don't store warm food or evaporating liquid in the appliance.
- Place the appliance in a well ventilated, humidity free room. Please refer to Installing your new appliance chapter.
- The "STRUCTURE ILLUSTRATION" shows the correct combination for the drawers, crisper and shelves, do not adjust the combination as this is designed to be the most energy efficient configuration.

### Hints for fresh food refrigeration

- Do not place hot food directly into the refrigerator or freezer, the internal temperature will increase resulting in the compressor having to work harder and will consume more energy.
- Do cover or wrap the food, particularly if it has a strong flavor.
- Place food properly so that air can circulate freely around it.

### Hints for freezing

- When first starting-up or after a period out of use, let the appliance run at least 2 hours on the higher settings before putting food in the compartment.
- Prepare food in small portions to enable it to be rapidly and complete frozen and to make it possible to subsequently thaw only the quantity required.
- Wrap up the food in aluminum foil or polyethylene food wraps which are airtight.
- Do not allow fresh, unfrozen food to touch the food which is already frozen to avoid temperature rise of the latter.
- Iced products, if consumed immediately after removal from the freezer compartment, will probably cause frost burns to the skin.
- It is recommended to label and date each frozen package in order to keep track of the storage time.

### Hints for refrigerator

- Meat (All Types) Wrap in polythene food: wrap and place on the glass shelf above the vegetable drawer. Always follow food storage times and use by dates suggested by manufacturers.
- Cooked food, cold dishes, etc.: They should be covered and may be placed on any shelf.
- Fruit and vegetables: They should be stored in the special drawer provided.
- Butter and cheese: Should be wrapped in airtight foil or plastic film wrap.
- Milk bottles: Should have a lid and be stored in the door racks.

### Hints for the storage of frozen food

- Ensure that frozen food has been stored correctly by the food retailer
- Once defrosted, food will deteriorate rapidly and should not be re-frozen. Do not exceed the storage period indicated by the food manufacturer.

### Switching off your appliance

- If the appliance needs to be switched off for an extended period, the following steps should be taken prevent mould on the appliance.

1. Remove all food;
2. Remove the power plug from the mains socket;
3. Clean and dry the interior thoroughly;
4. Ensure that all the doors are wedged open slightly to allow air to circulate.



## 11. CLEANING AND CARE

- For hygienic reasons the appliance (including exterior and interior accessories) should be cleaned regularly at least every two months.

### WARNING:

The appliance must not be connected to the mains during cleaning. Danger of electrical shock! Before cleaning switch the appliance off and remove the plug from the mains socket.

### Exterior cleaning

- To maintain good appearance of your appliance, you should clean it regularly. Wipe the digital panel and display panel with a clean, soft cloth.
- Spray water onto the cleaning cloth instead of spraying directly on the surface of the appliance.
- This helps ensure an even distribution of moisture to the surface.
- Clean the doors, handles and cabinet surfaces with a mild detergent and then wiped dry with a soft cloth.

### Caution!

- Don't use sharp objects as they are likely to scratch the surface.
- Don't use Thinner, Car detergent, Clorox, ethereal oil, abrasive cleansers or organic solvent such as Benzene for cleaning. They may damage the surface of the appliance and may cause fire.

### Interior cleaning

- You should clean the appliance interior regularly. It will be easier to clean when food stocks are low. Wipe the inside of the fridge freezer with a weak solution of bicarbonate of soda, and then rinse with warm water using a wrung-out sponge or cloth. Wipe completely dry before replacing the shelves and baskets. Thoroughly dry all surfaces and removable parts.

### Caution!

- Don't use sharp objects to remove frost from the freezer. Only after the interior completely dry should the appliance be switched back on and plugged back into the mains socket.

### Door seals cleaning

- Take care to keep door seals clean. Sticky food and drinks can cause seals to stick to the cabinet and tear when you open the door. Wash seal with a mild detergent and warm water. Rinse and dry it thoroughly after cleaning.

### Caution!

- Only after the door seals are completely dry should the appliance be powered on.

## 12. DOOR REVERSE

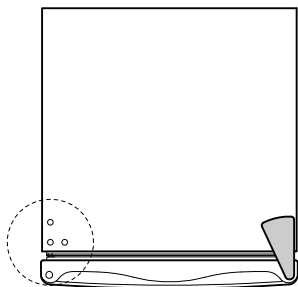

① Remove the hole cover.

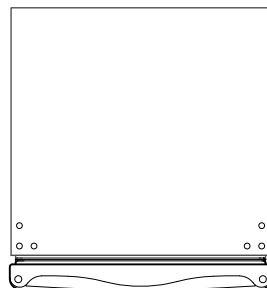

② Remove hinge cover and top hinge with a "+" screwdriver, then remove the door.

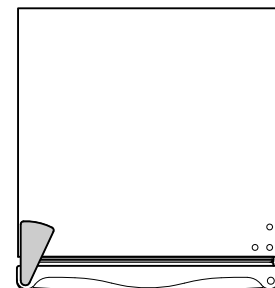

④ Put on the door to bottom hinge, then fix top hinge and cover.

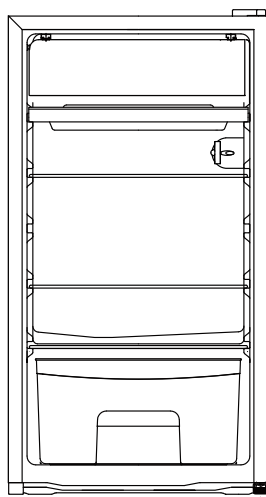

③ Remove the foot and bottom hinge, fix them to opposite side.

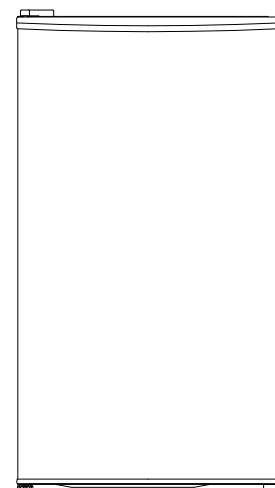

⑤ Fix the hole cover, completed.

## 13. TROUBLESHOOTING

- If your device shows the other symptoms that those described below, please call the service after sale of the shop a retailer.

Symptom	Cause	Solution
The appliance does not work.	There is no power supply.	Check the plug connecting it others appliance, or verify that the appliance is connected to the plug.
	The fuse doesn't work.	Replace the fuse.
The appliance makes a lot of noise.	The appliance is too close to the wall, or is not stable, or the accessories inside the refrigerator are placed in wrong position.	Stabilize the base of the refrigerator by adjusting the position of feet, take away the device of the wall, place correctly the accessories inside the refrigerator.
The appliance doesn't cool enough.	The door is too often opened or was left opened for a long time.	Close the door and do not open it too much frequently.
	The refrigerator is too close to the wall.	Take away the device of the wall to favor the ventilation.
	The refrigerator is too full.	Remove food of the device.

Symptom	Cause	Solution
The appliance doesn't cool enough.	The temperature is badly adjusted.	Turn the knob of regulation of temperature on "3" or more
There are smells in the appliance.	Food made obsolete inside the refrigerator.	Throw away obsolete food and wrap the other.
	The inside of the device at need to be cleaned.	Clean the inside of the refrigerator.

### The following symptoms are not breakdowns:

- The noise of the cooling liquid which circulates in pipes can be heard, it is normal.
- The humidity on the surface outside of the device during the wet seasons is not a problem of the device; you just need to wipe it with a dry soft cloth.
- The compressor and the condenser can warm more during the periods of strong heat.
- The frame of the door is a bit hot; it means that the condenser works to evacuate the humidity of air.

## 14. ENVIRONMENTAL TIPS

Observe all safety and warning information during operation (see the "General Safety Instructions" section).

### 14.1 Disposal considerations

The transport and protective packaging has been selected from materials which are environmentally friendly for disposal, and can normally be recycled.

Recycling the packaging reduces the use of raw materials in the manufacturing process and also reduces the amount of waste in landfill sites. Ensure that any plastic wrappings, bags etc. are disposed of safely and kept out of the reach of babies and young children. Danger of suffocation.



### 14.2 Disposing of your old appliance

Electrical devices marked with this label may not be disposed of in domestic waste at the end of their service life.

Electrical and electronic appliances often contain valuable materials. They also contain specific materials, compounds and components, which were essential for their correct function and safety. These could be hazardous to human health and to the environment if disposed of with your domestic waste or if handled incorrectly. Please do not, therefore, dispose of your old appliance with your household waste.

Please dispose of those materials by contacting your local authorities and ask for the correct method of disposal. Please ensure that your old appliance poses no risk to children while being stored prior to disposal.

By disposing of this product in accordance with the regulations, you protect the environment and the health of those around you from negative consequences.

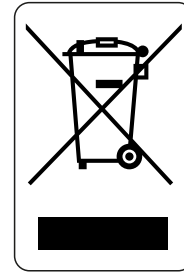

## 15. WARRANTY & AFTER SALES SERVICE

Observe all safety and warning information during operation (see the "General Safety Instructions" section).

In the event of a fault which you cannot remedy yourself, please contact Linärie.

### 15.1 Warranty

The manufacturer's warranty for this appliance is 2 years.

### 15.2 After sales service

The contact details for Linärie are given at the beginning and of these instructions.

When contacting Linärie, please quote the model and serial number of your appliance. These can be found on the data plate, after removing the grease filter.

### Record model & serial number

Model:.....

Serial Number:.....

Register your product [www.linarie.com.au](http://www.linarie.com.au)

### 15.3 Replacement of spare parts

Incorrect components can lead to personal injury or damage to the appliance. Use only genuine original Linärie spare parts.



Modifications, additions or alterations to the appliance can lead to safety risks. If spare parts or accessories from other manufacturers are used, the warranty will be invalidated, and Linärie cannot accept liability.

Please check [www.linarie.com.au](http://www.linarie.com.au) for more information.

## LIKE TO KNOW MORE?

For further information on all Linärie appliances,  
or to obtain detailed dimension and installation  
information, phone or email our Customer Care  
team or visit our website:

Australia  
[hello@linarie.com.au](mailto:hello@linarie.com.au)  
[www.linarie.com.au](http://www.linarie.com.au)

Follow Us  
[@Linärie.Appliances](#)  
  

Operating and installation instructions:

Original

√ Translation

**Mart Online Services Pty Ltd.**  
**ACN 657 824 050**

**Linärie Contact**  
**hello@linarie.com.au**  
**www.linarie.com.au**

The distribution and duplication of this document, as well as the use and disclosure of its contents are prohibited unless expressly authorised.

These operating and installation instructions have been drawn up with the greatest of care. But it cannot be ruled out that subsequent technical modifications have not yet been incorporated or the relevant content has not yet been adapted. Please accept our apologies in this eventuality. An updated version can be requested from our team. Subject to printing errors and mistakes.

© Linärie

All rights reserved.