

laundry collection

Instructions for use and warranty details

To register your warranty or make a warranty claim, scan this QR code:



Front Vented Clothes Dryer

Model No.: LDVF70

 **kLEENmaid**

Dear Customer,

Thank you and congratulations for choosing Kleenmaid.

Your new appliance has been designed and meticulously tested to ensure that it meets all your culinary requirements, and has been carefully manufactured using top quality materials to give you years of reliable performance.

For best results, carefully read the instructions on how your new appliance is to be installed. Correct installation will avoid delays and unnecessary service call costs.

Once installation is complete, please read this instruction manual carefully and get to know the controls and the features of your new Kleenmaid appliance. These simple instructions will enable you to achieve excellent results from the very first time you use it.

Again, congratulations and thank you for choosing The Best You Can Own.

KLEENMAID

CONTENTS

SAFETY INSTRUCTIONS

- Safety Instructions 4

INSTALLATION

- Product Description 10
- Installation 10

OPERATION

- Quick Start..... 13
- Before each Drying Load..... 14
- Control Panel..... 15
- Drying Program Table 16

MAINTENANCE

- Cleaning and Care 17
- Trouble Shooting 19
- Technical Specifications..... 20

SAFETY INSTRUCTIONS

Please read this user manual before using the clothes dryer and retain the manual for further consultation. The latest version of this manual is available on our website. (See back cover for details.)

■ Safety Instructions



CAUTION: RISK OF FIRE!

- The appliance is not intended for use by persons (including children) with reduced physical, sensory or mental capabilities, or lack of experience and knowledge, unless they have been given supervision or instruction concerning use of the appliance by a person responsible for their safety.
- Children should be supervised to ensure that they do not play with the appliance.
- Cleaning and user maintenance shall not be made by children.
- If the supply cord is damaged, it must be replaced by the manufacturer, its service agent or similarly qualified persons in order to avoid a hazard.
- Children shall not play with the appliance.
- The tumble dryer is not to be used if industrial chemicals have been used for cleaning.
- The lint trap has to be cleaned frequently.
- Lint must not be allowed to accumulate around the tumble dryer.
- Do not dry unwashed items in the tumble dryer.
- Items that have been soiled with substance such as cooking oil, acetone, alcohol, petrol, kerosene, spot removers, turpentine, waxes and wax removers should be washed in hot water with an extra amount of detergent before being dried in the tumble dryer.
- Items such as foam rubber (latex foam), shower caps, waterproof textiles, rubber backed articles and clothes or pillows fitted with foam rubber pads should not be dried in the tumble dryer.
- Fabric softeners, or similar products, should be used as specified by the fabric softener instructions.

Warning!

Never stop a tumble dryer before the end of the drying cycle unless all items are quickly removed and spread out so that the heat is dissipated.

SAFETY INSTRUCTIONS

- The exhaust air must not be discharged into a flue which is used for exhausting fumes from appliances burning gas or other fuels.
- The appliance must not be installed behind a lockable door, a sliding door or a door with a hinge on the opposite side to that of the tumble dryer, in such a way that a full opening of the tumble dryer door is restricted.
- Oil-affected items can ignite spontaneously, especially when exposed to heat sources such as in a tumble dryer. The items become warm, causing an oxidation reaction in the oil. Oxidation creates heat. If the heat cannot escape, the items can become hot enough to catch fire. Piling, stacking or storing oil-affected items can prevent heat from escaping and so create a fire hazard.
- The appliance should not be overturned during normal use or maintenance.
- Remove all objects from pockets such as lighters and matches.
- Ventilation openings in the base must not be obstructed by carpets or other floor coverings.
- Plug must be accessible after installation.
- Warning: The appliance must not be supplied through an external switching device, such as a timer, or connected to a circuit that is regularly switched on and off by a utility.
- Remove all packaging before using the appliance, otherwise serious damage may result.
- Adequate ventilation has to be provided to avoid the back flow of gases into the room from appliances burning other fuels, including open fires.

SAFETY INSTRUCTIONS

Correct Disposal of this Product



This marking indicates that this product should not be disposed with other household wastes throughout the EU. To prevent possible harm to the environment or human health from uncontrolled waste disposal, recycle it responsibly to promote the sustainable reuse of material resources. To dispose of your used device, please contact your local waste disposal service. They can take this product for environmentally safe recycling.

Model	Rated capacity
LDFV70	7.0kg

SAFETY INSTRUCTIONS

Power Supply and Grounding

- The dryer employs alternating current with the rated voltage and frequency. When the voltage fluctuates up to 6% of rated voltage, the dryer can work normally.
- A special power socket with a capacity $\geq 10A$ for the dryer should be close to the dryer for convenience and safety. The method of connection of the socket is as the figure on the right.
- To ensure safe operation, please make improvements as soon as possible according to the directions above.
- The appliance corresponds to Protection Class I and may only be connected to a plug with a protective conductor that has been installed properly. When connecting the appliance to the mains, make sure that the mains voltage is correct. You can find more information about this on the rating plate.
- The electrical safety of this tumble dryer can only be guaranteed when correctly earthed. It is essential that this standard safety requirement is met. If in any doubt, please have the household wiring system tested by a qualified electrician. The manufacturer cannot be held liable for the consequences of an inadequate earthing system (e.g. electric shock).

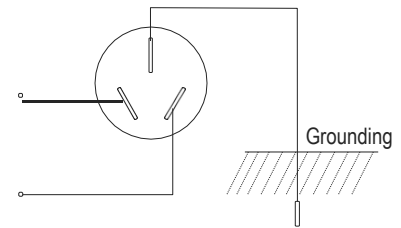

Warning!

The socket and the grounding wire must be installed by an electrician to prevent incorrect installation or use of the socket and to guarantee the safe use of electricity. There must be NO connection of the grounding wire and the neutral wire, otherwise the cabinet will be charged, causing the danger of electric shock.



WARNING: IT MUST BE ENSURED THAT THIS APPLIANCE IS CONNECTED ONLY TO A 230vac +10%/-6% 50Hz MAINS POWER SUPPLY WHICH CONTINUOUSLY COMPLIES WITH THE RELEVANT AUSTRALIAN STANDARD. FAILURE TO DO SO MAY SERIOUSLY DAMAGE THE APPLIANCE AND ANY SUCH DAMAGE IS NOT COVERED BY THE MANUFACTURER'S WARRANTY.



SAFETY INSTRUCTIONS

• Precautions

Install or store the dryer where it will not be exposed to temperatures below freezing or exposed to water or weather, which could cause permanent damage and invalidate the warranty.

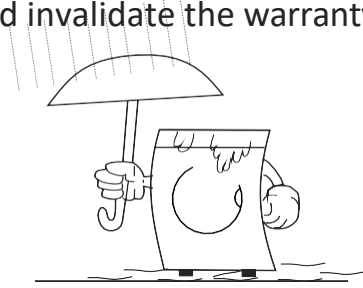

Keep area around the exhaust opening and adjacent surrounding areas free from the accumulation of lint, dust and dirt. An obstructed port might reduce the airflow.

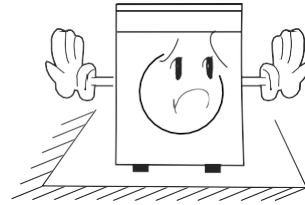

Thoroughly spin the laundry in washing machine before drying. High spin speed can reduce the drying time and save energy.

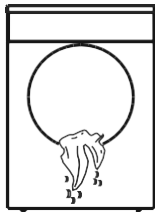

Make sure combustible sprays will not be close to the dryer when it is working. If gas leaks nearby, do not touch plug or start/pause the dryer.

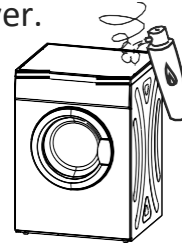

Do not wash or dry articles that have been cleaned in, washed in, soaked in or spotted with combustible or explosive substances (such as wax, oil, paint, gasoline, degreasers, dry-cleaning solvents, kerosene, etc.).

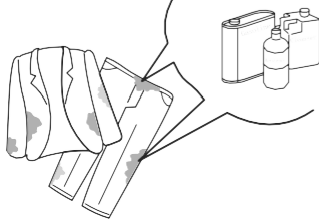

Never attempt to operate this appliance if it is damaged, malfunctioning, partially disassembled, or has missing or broken parts, including a damaged cord or plug.

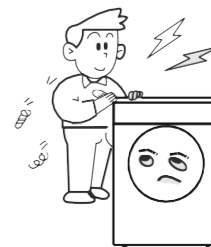

SAFETY INSTRUCTIONS

Do not allow children on or in the appliance. Close supervision of children is necessary when the appliance is used near children.

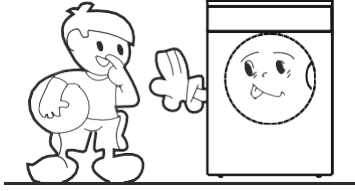

Do not use the machine when your hands are wet.

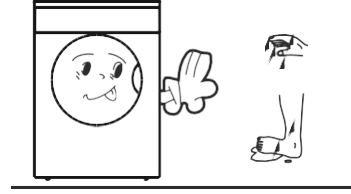

Do not store plastic, paper or clothing that may burn or melt on top of the dryer during operation.



The exhaust air must not be discharged into a flue which is used for exhausting fumes from appliances burning gas or other fuels.

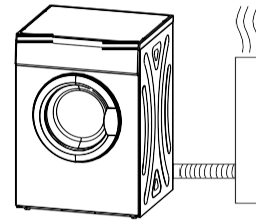

Do not dry articles containing rubber, plastic or similar materials such as padded bras, tennis shoes, galoshes, bath mats, rugs, bibs, baby pants, raincoats, plastic bags or pillows that may melt or burn. Some rubber materials, when heated, can under certain circumstances produce fire by spontaneous combustion.



The door shall be opened only after the program of the drying machine is completed. Do not open the door before the program is finished to avoid human skin being scalded by hot steam or an overheated dryer.

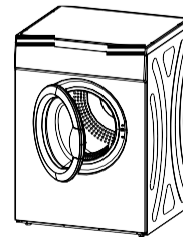

INSTALLATION

■ Product Description

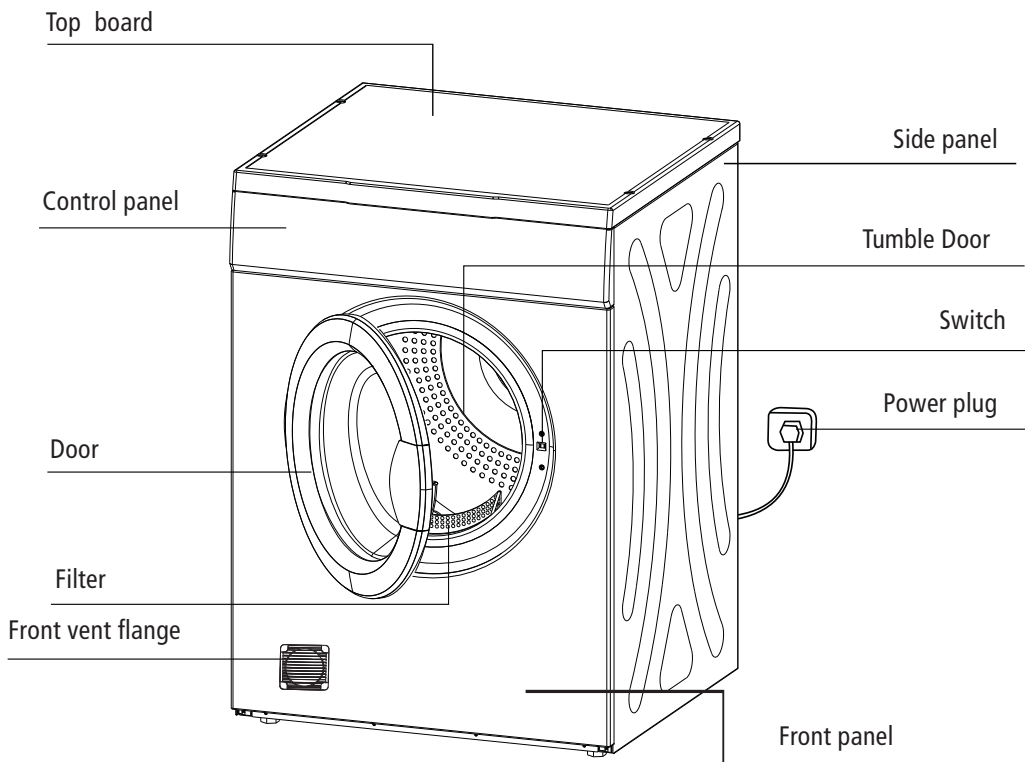

Installation

• Packing the clothes dryer

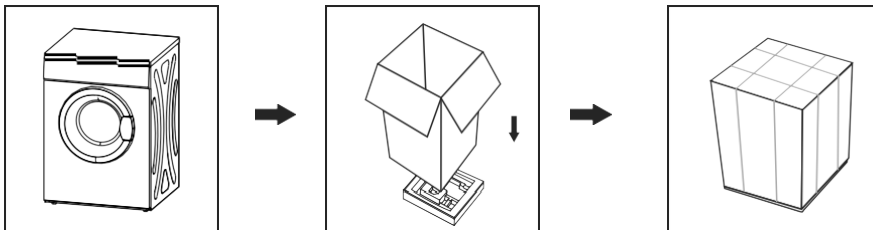

• Unpacking the clothes dryer

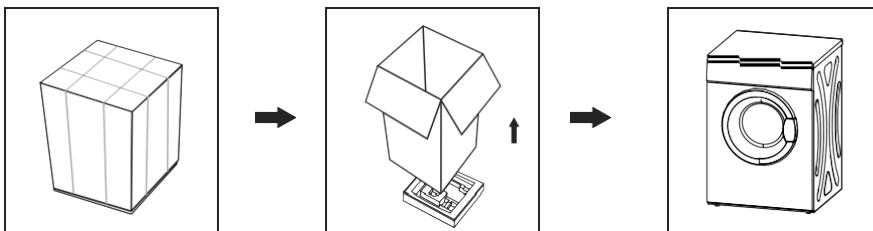

The packaging of this clothes dryer includes a large square clear plastic protective stand, which is stored on the top of the dryer when in transit, and when removed may be placed under the dryer when standing on a washer or on the floor. This piece should not be disposed of with packaging materials. If desired, it may be used on top of a wall mounted dryer to protect the surface from dust and other particles.

⚠ Warning!

- Packaging material (e.g. Films, Styrofoam) can be dangerous for children.
- There is a risk of suffocation ! Keep all packaging well away from children.

INSTALLATION

- **Installation Position**

Dryer should be placed in a ventilated area with not less than 10cm distance from the wall. It is suggested there are no obstacles within 1.5m in front of the dryer to assure ventilation.

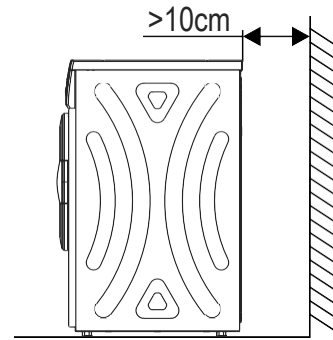

- **Level Adjusting**

Once in its permanent operating position, check that the dryer is absolutely level with the aid of a spirit level. If it is not, adjust the feet with a tool.

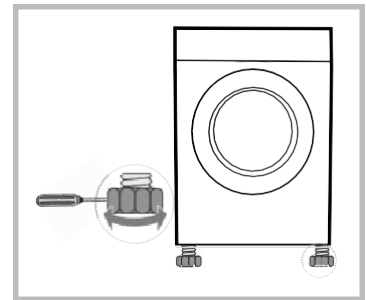

Note!

If the dryer is not placed horizontally (ie. the lean angle is no more than 2°), the dryer may become unbalanced or not work properly.

Notice when installing:

- Do not install the dryer in the open air or a place where it can be damaged easily by rain.
- Do not place the back of dryer near curtain or something moved by wind.
- Do not place the dryer near gas or flammable materials.
- When installing the clothes dryer by attaching to a wall please follow the directions in the Wall Hanging Installation Instructions on page 12 of the user manual.
- Before making preparations for or commencing installation, the installer should refer to the current online version of the User Manual, which is available on the Kleenmaid website (see back cover for details).

Wall Hanging Installation Instructions

1. The Accessory Kit includes the following components: Hooks (2), Standoffs (2), Anchor bolts (4), Installation positioning paper (1).

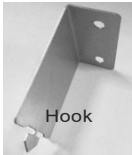

2. Hanging Procedure:

Step 1: Confirm that all components are in the Accessory Kit.

Step 2: Determine the wall construction and a suitable position for dryer installation.

- a. Dryer should only be attached to a solid wall.
- b. The clearance distance in front of the wall must be more than 150cm.

Step 3: Paste the installation positioning paper to the solid wall.

- a. The bottom edge of the positioning paper must be at least 45cm higher than the floor. Draw a line with a level, as a base for the positioning paper. (Note: Ensure the marked screw holes do not overlap with nearby power outlets or taps.)
- b. Remove the adhesive paper from the back of the positioning paper, and paste the positioning paper to the wall horizontally.



Step 4: Drill holes for anchor bolts. Find the hole mark on the positioning paper and using a 14mm drill bit drill 4 holes according to the positioning paper drawing (hole depth 60mm). Use an appropriate 14mm drill bit to pre-drill in tiled walls.



Step 5: Fix the hook to wall with an anchor bolt.

- a. Using the anchor bolt from the Accessory Kit, insert the anchor bolt and tube into the drilled holes. Attach one nut to each bolt. To prevent the thread being damaged, don't expose the end-thread of the bolt. Hammer the 4 bolts into the holes.



- b. After the bolts are hammered into the wall, remove the nuts and expose the bolts. Place a suitably sized auxiliary tube over the bolt, and hammer the tube until the anchor tube is flush with the wall surface.



- c. Remove the hooks from the Accessory Kit and attach to the bolts with a socket or a wrench.

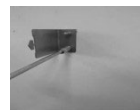

Step 6: Fix the standoffs to the clothes dryer. Place the unpackaged clothes dryer on the floor. Remove the appropriate two screws at the back of the appliance with a Phillips head screwdriver. Thread the screws through the holes in the standoffs and then fasten them into the original screw holes.

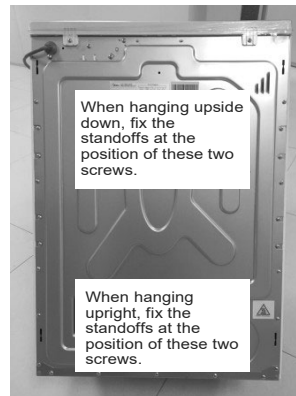

Step 7: Have 2 people lift the clothes dryer and align the slots at the back of the dryer with the hooks. Insert the hooks firmly into the slots and lower dryer onto hooks.



Step 8: If necessary, fit the inverted control panel label over the existing control panel label.

WARNING: To avoid possible injury use two or more people to move and install the dryer.

OPERATION

■ Quick Start

Note!

Before use, please make sure the tumble dryer is installed properly.

Before Drying

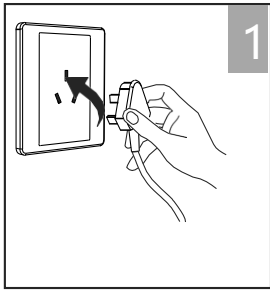

plug in

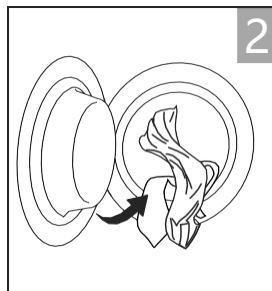

load

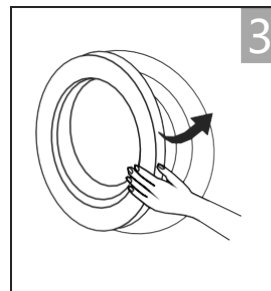

close the door

Drying



on



select function
or default



start

After Drying

Alert buzzer sounds.

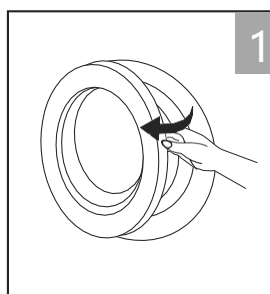

unload

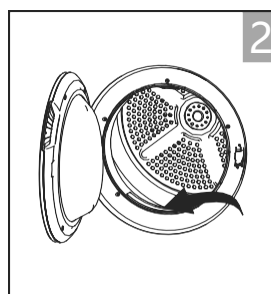

clean filter

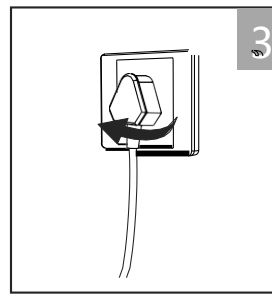











unplug

OPERATION

■ Before each Drying Load

1. Before drying, thoroughly spin the laundry in a washing machine. High spin speed can reduce the drying time and save energy consumption.
 2. For uniform drying result, sort the laundry according to fabric type and drying program.
 3. Before drying, please close zips, hooks and eyelets, douppbuttons, tie fabric belts, etc.
 4. Do not over dry the clothes, because over dried clothes can easily get creases.
 5. Do not dry articles containing rubber or similar elastic materials.
 6. The door should be opened only after the dryer program is completed. Do not open the door before the program is finished to avoid skin being scalded by hot steam or an overheated dryer.
 7. Clean the lint filter after each use to avoid extension of drying time and higher energy consumption.
 8. Do not dry clothes that have been dry cleaned.
- Reference weight of dry clothes (1 piece)

 Sweater (about 800g)	 Jacket (about 800g cotton)	 Jeans (about 800g)	 Bath towel (about 900g cotton)
 Single bedsheet (about 600g cotton)	 Work clothes (about 1120g)	 Sleepwear (about 200g)	 Long sleeve shirt (about 300g cotton)
 T-shirt (about 180g cotton)	 Underwear (about 70g cotton)	 Socks (about 50g mixed-weave)	

Note!

- Do not overload the dryer.
- Not suitable for dripping wet textiles. The dryer could be damaged or even catch fire.
- Not suitable for silk or woolen textiles.

Only dry articles suitable for tumble drying. Check laundry care labels before drying:

- Suitable for tumble drying
- Normal drying process: Drying in the tumbler is possible under normal load and temperature 80°.
- Mild drying process: Caution is appropriate when tumble drying. Select mild program with reduced thermal action.
- Do not tumble dry: Articles unsuitable for drying in the tumbler.

OPERATION

■ Control Panel

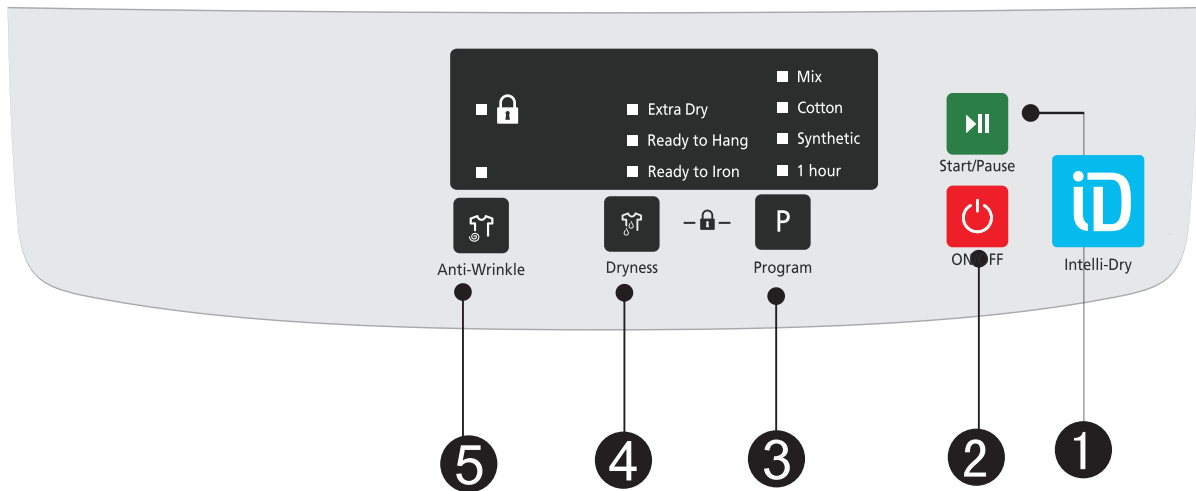

1 On/Off

Product is switched on or off.

2 Start/Pause

Press the button to start or pause the drying cycle.

3 Program

Different Dryer cycles (1 Hour, Cotton, Synthetic or Mix) can be selected according to the user's needs for the most effective drying results.

4 Dryness Level

Intelli-Dry electronic controls with 3 levels - Ready to Iron, Ready to Hang and Extra Dry

5 Anti-Wrinkle

At the end of the drying cycle, the anti-wrinkle phase time is 30 minutes (default) or 120 minutes (selected). The anti-wrinkle indicator will flash while this phase is active.

Note!

- Press the **【On/Off】** button to switch on the machine
- Press the **【Program】** button to select the desired programme.
- Press the **【Dryness Level】** button to select the desired dry grade.
- Press the **【Anti-Wrinkle】** button to activate Anti-Wrinkle function.
- Press the **【Start/Pause】** button to start the program.
- To active the child lock function, press the **【Program】** and **【Dryness Level】** buttons simultaneously for 3 seconds.
- The buzzer will prompt when the cycle is finished. Press the **【On/Off】** button and **unplug** the power cable.
- Clean the filter, cabinet and drum.

OPERATION

■ Drying Program Table

Program		Max Load	Application/Properties
Cotton	Extra Dry	7.0kg	For single or multi-layer cotton laundry to be dried completely for direct storage.
	Ready to Hang		
	Ready to Iron		For single layer cotton laundry to remain damp for ironing.
Mix	Extra Dry	3.5kg	For thick or multi-layer mixed fabrics to be dried completely .
	Ready to Hang	3.5kg	For mixed fabrics from cotton and synthetics.
Synthetics	Extra Dry	3.5kg	For thick or multi-layer synthetic fabrics to be dried completely .
	Ready to Hang		To dry thin synthetic textiles, which are not ironed, such as easy care shirts, baby cloths or socks.
1Hr		1.0kg	To dry individual items.

Note!

- Please select the suitable Program and Dryness Level according to the Type and Care labels of the clothing.

Note!

- If Anti-Wrinkle option is selected, the anti-wrinkle process will be 2 hours, otherwise the Anti-wrinkle process terminates after 30min without this option.
- The room temperature and humidity will affect the drying time.
- Check the clothes care label and choose the corresponding program accordingly.
- “Cotton + Extra Dry” is for AS/NZS energy program.

MAINTENANCE

■ Cleaning and Care

Filter clean

- Clean the lint filter after each use.
Remove the filter by pulling it straight up.
- Filter cleaning
Use a cloth or your hands to remove lint.
- Install filter
If the filter is cleaned by damp cloth or water, please dry thoroughly before installation.

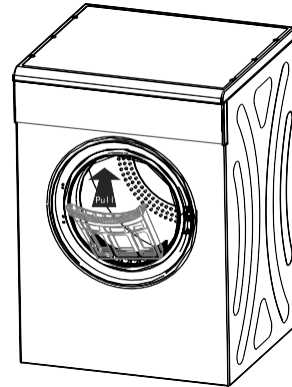

Cleaning cabinet and drum

WARNING!

- Disconnect the power cord before cleaning!
- Clean the dryer with a wet cloth which is only dampened by clean water.
- Do not pour water directly over the machine.
- Do not use solvents, abrasive cleaners, glass cleaners or all-purpose cleaners. These could damage plastic surfaces and other parts.
- Before starting the dryer, dry all parts with a soft cloth.

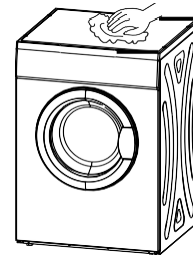

MAINTENANCE

Safety reset

1. This dryer has a safety cut out switch which is activated by temperature.
2. If your dryer is not heating this button must be reset, before the dryer can heat again.
You may need to wait 10 minutes for cooling down.
The safety reset button is on the backboard of the dryer. See image below.
3. The most common reason for the dryer to overheat is a blocked filter.
4. Clean the lint filter after each cycle to prevent overheating of the dryer.

The safety cut out switch may operate for the following reasons:

1. Lint filter is blocked.
2. Exhaust outlets blocked at the back of the dryer.
3. The room is poorly ventilated. Open the windows or the door.
4. Lightweight garment eg. handkerchief, sucked over the filter.

Safety Reset Button

Use your finger or a pencil to press the button in until you feel it click.

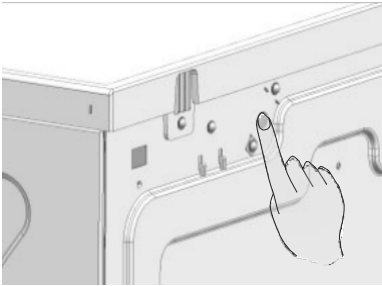

MAINTENANCE

■ Trouble Shooting

Problem	Cause	Solution
Dryer does not start *	<ul style="list-style-type: none"> • Power cut off. • The power plug is not plugged firmly. • The dryer is overloaded. • The temperature fuse is cut. 	<ul style="list-style-type: none"> • Wait for restoration of electricity. • Check the power socket to make sure the plug is inserted firmly. • The clothes must be spun to remove excess water and the drying load cannot exceed the rated capacity. • Replace the temperature fuse.
The appliance gets hot or there is a burning smell	<ul style="list-style-type: none"> • The lint filter is clogged. • The uptake or exhaust duct is clogged. 	<ul style="list-style-type: none"> • Make sure to clean the lint filter after each cycle. • Clean the exhaust duct.
Clothes are too dry	<ul style="list-style-type: none"> • The machine is overloaded. • Clothes are not removed from dryer after end of program. • Clothes are not sorted properly. • The selected temperature is too high. 	<ul style="list-style-type: none"> • Do not exceed the rated capacity. • Take out the clothes immediately after the program ends. • Follow the instructions on the care label on clothes.
Clothes shrink	<ul style="list-style-type: none"> • Laundry is over-dried. 	<ul style="list-style-type: none"> • Follow the instructions on the care label on clothes. • If items are sensitive to shrinking, examine the clothes when dry. Take out the clothes when damp, then hang the clothes until fully dry.
Pilling on clothes	<ul style="list-style-type: none"> • Laundry is sensitive to rubbing. 	<ul style="list-style-type: none"> • Use fabric softener to lubricate fibres, please spray laundry starch on cuff and neckline when ironing clothes. Turn the laundry inside out to avoid pilling

* If the safety cutout switch is activated due to the dryer overheating it will need to be reset before the dryer will operate. See page 18 for details.

- Heavy wet clothes turning and bumping will cause noise accordingly while to dryer runs. During the drying cycle, the machine will create airflow, which will cause noise when hitting the drum.

NOTE: If this appliance does not start, or it stops during operation use the information on pages 19 & 20 to try to find a solution. If the issue is cannot be resolved, contact a service centre. Please see the instructions on the back cover of this user manual to request a warranty service. You will need the Model Code (LDVF70) and individual Serial Number which is found on the Rating Label at the centre top of the back of the dryer.

MAINTENANCE

Other failure

Display	Reason	Solutions
LED 【Ready to Iron】 and 【Ready to Hang】 flashing	Temperature sensor broken or PCB failure	Please contact your local service center if the problem occurs.
LED 【Ready to Hang】 flashing	NTC or PCB failure	
LED 【Extra Dry】 flashing	Temperature Sensor has short circuited or PCB fault	

■ Technical Specification

Model	LDVF70
Parameters	
Dimension (L*W*H)	555*595*840(mm)
Rated input power	2000W
Rated voltage	220-240V~
Rated frequency	50Hz
Weight of product	35kg
Rated capacity	7.0kg
Ambient temperature	+5°C~+35°C

Note!

- The rated capacity is the maximum capacity. Make sure that the clothes which are loaded to the appliance do not exceed the rated capacity any time.
- Do not install the tumble dryer in a room where the temperature is around freezing point, or there is a risk of frost occurring, as the tumble dryer may not be able to operate efficiently.

KLEENMAID WARRANTY

TERMS AND CONDITIONS

1. Compass Capital Services Pty Ltd ABN 96 138 214 525 trading as Kleenmaid will provide parts and labour to you the customer as set out herein.
2. Kleenmaid may engage a Service Agent to provide service under this warranty.
3. Kleenmaid's Products come with guarantees that cannot be excluded under the Australian Consumer Law. You are entitled to a replacement or refund for a major failure and for compensation for any other reasonably foreseeable loss or damage. You are also entitled to have the goods repaired or replaced if the goods fail to be of acceptable quality and the failure does not amount to a major failure.
4. The benefits given to you under this Kleenmaid Warranty are in addition to other rights and remedies to which you may be entitled under the Australian Consumer Law in relation to the Product to which this Kleenmaid Warranty relates. Subject to the conditions below, the Product is warranted by Kleenmaid and/or its agents to be free from defects in materials and workmanship for the Warranty Period for normal Domestic Use.
5. Product Identification: -
 - a. Kleenmaid reserves the right to reject claims for any services or work where you cannot produce for verification the serial number and a proof of purchase for the Product (including but not limited to the original invoice).
 - b. this Kleenmaid Warranty will be voided if the serial number for the Product cannot be verified. This is not intended to exclude, restrict or modify any right or remedy to which you may otherwise be entitled under the consumer guarantee provisions of the Australian Consumer Law.
 - c. in the event that a request for repair is made against this Kleenmaid Warranty where the serial number for the Product cannot be verified or you cannot produce for verification a proof of purchase for the Product (including but not limited to the original invoice), the repairer will not carry out any repairs on the Product and you will be charged a service call-out fee.
6. What is covered by this Kleenmaid Warranty: -
 - a. the Product is covered for faulty workmanship or parts that have failed under normal Domestic Use.
 - b. Kleenmaid and/or its agents will determine by objective testing if there are any defects in the Product and/or faulty workmanship.
 - c. this Kleenmaid Warranty is only applicable if repairs on Products are carried out within Mainland Australia.
 - d. this Kleenmaid Warranty: -
 - i. covers a Product purchased as new, manufactured for use in Mainland Australia;
 - ii. commences from the date of delivery of the Product;
 - iii. provides for the labour and replacement parts necessary to maintain the Product in good operating condition as specified in this Kleenmaid Warranty, however, if repair is needed because of Product failure during normal Domestic Use, Kleenmaid has the option to repair or replace the defective Product or part of the Product with a product or part of like kind and quality. A replacement part may be new or reconditioned of like kind and quality and may cost less than the original Product purchased and no charges or refunds will be made based on the replacement product or part cost difference; and
 - iv. is only applicable when the Product is used and operated in accordance with the Manufacturer's instructions.
7. What is not Covered by this Kleenmaid Warranty (excluded):-
 - a. any damage or failure to or of the Product or part of the Product:
 - i. due to the Product being inadequately serviced to manufacturer's recommendations;
 - ii. resulting from environmental conditions including and not limited to dirt, dust, rodents, insects, rust, corrosion, salt built-up, or of in any part of the Product;
 - iii. resulting from excessive use but fair wear and tear is excepted;
 - iv. resulting from installation by an unqualified or uncertified tradesperson;
 - v. resulting from poor or incorrect installation including and not limited to positioning and externally fitted equipment such as plumbing and drainage, cabling, antennae or due to incompatibility of connected equipment;
 - vi. caused by overheating as a result of sitting or positioning of the Product, where there is no provision for adequate ventilation or adequate protection from excessive dust;
 - vii. if the Product has been dismantled, repaired or serviced by any person other than someone authorised by Kleenmaid or its agents or representatives;
 - viii. caused by power surges or spikes, including and not limited to, mains power and telecommunications connections, or to other unspecified sources, incorrect power current, voltage fluctuation, amperage fluctuation, rust or corrosion;
 - ix. if the Product is dropped, collision of the Product with another object, use for which the Product is not designed, damage to the Product caused by your own negligence, accidental or deliberate misuse of the Product by you, theft, abuse, vandalism, flood, fire, earthquake, electrical storms or any other act of God or any war related events; or
 - x. due to the introduction of abnormal heat loads to the Product;
 - b. costs of attendance and testing where no fault or defect covered by the terms of this Kleenmaid Warranty is identified in the Product;
 - c. initial setup and installation of the Product;
 - d. normal maintenance costs and costs incurred through the installation of items listed as requiring periodic replacement;
 - e. Products with removed or altered serial numbers;
 - f. broken or cracked glass other than transport damage to the initial point of delivery;
 - g. consumables such as but not limited to bulbs/globes, seals, filters, batteries and remote controls;
 - h. removal and reinstallation of an internal component not performed by an authorised Kleenmaid agent or representative or authorised service centre;
 - i. cosmetic or structural items; or
 - j. any failures due to interference from or with other products and/or sources.
8. This Kleenmaid Warranty ceases if: -
 - a. the Product ceases to carry the original manufacturer's serial number or is sold at an auction;
 - b. the Product is rented; or
 - c. there is failure to pay monies owing on invoices as a result of non-warranty work being carried out at the request of the end user as per point 16 below.

9. Service under this warranty may be limited by the area in which you live. Service to remote and regional areas may incur additional travel costs which will be payable by you. You will be advised of this at the time you make a claim and Kleenmaid arranges to attend your premises.
10. Neither Kleenmaid nor its representatives provide loan equipment under the terms of this Kleenmaid Warranty.
11. Any unauthorised access to the internal hardware of the Product will void this Kleenmaid Warranty.
12. Repair Notice: Products presented for repair may be replaced by refurbished Products of the same type rather than being repaired. Refurbished parts may be used to repair the Products.
13. Replacement items are "like for like" and is not "new for old" and does not indicate in any way that a faulty Product will be replaced with a new part or unit. "Like for like" may either be a quality checked, refurbished or reconditioned unit of the same or later batch of model/size/specifications
14. The cost of making a claim under this Kleenmaid Warranty is not covered by Kleenmaid, including any costs of transportation or travel expenses between your home and your nearest authorised service agent.
15. Kleenmaid accepts no liability for items that are lost, damaged, or stolen as a result of freight, transport or storage. If you are required to transport the Product to an authorised service centre, you must ensure that it is securely packed and insured.
16. On Public Holidays or other periods when regular business and wholesale operations are temporarily ceased, repairer availability and warranty response times may extend beyond the standard response times due to the unavailability of repairers and parts.
17. For any repair performed on a Product under this Kleenmaid Warranty where no fault can be found, or the item is deemed by Kleenmaid or an authorised agent, to be not faulty under this Kleenmaid Warranty, or the repair or fault is not covered under this Kleenmaid Warranty, a 'No Fault Found' fee is payable by you. Kleenmaid will advise you of this cost and seek your agreement to pay such costs before commencing such repairs.
18. Any repairs or services required that are outside the terms and conditions of this Kleenmaid Warranty can be carried out at your request at your cost (including where the Product has not been installed or set up correctly). Kleenmaid will always advise you of this cost and seek your agreement to pay such costs before commencing such repairs. A credit card may be required prior to the commencement of such services.
19. Extra charges will be payable by the customer should the Product not be readily accessible without special equipment, such as but not limited to cranes and lifts or should the Product be installed in a position that service access is blocked and/or repair work is not possible without uninstalling the Product to gain access.
20. You, the customer, may be entitled to purchase an extended warranty in respect of the Product. Any extended warranty will not be issued by Kleenmaid but by a third party. Any extended warranty services will be provided directly by the third party as principal and not as agent for Kleenmaid, under their extended warranty terms and conditions and not under this Kleenmaid Warranty.
21. To make a claim under this Kleenmaid Warranty, please have your proof of purchase and the serial number of the Product ready and call (02) 9310 1207 during business hours.
22. This Kleenmaid Warranty is given by:
 Name: Compass Capital Services Pty Ltd ABN 96 138 214 525 trading as Kleenmaid
 Business address: Level 2, Suite 3, 204 Botany Rd, Alexandria NSW Australia 2015
 Telephone: (02) 9310 1207
23. Definitions:
 - a. **Australian Consumer Law** means the *Competition and Consumer Act 2010* (Cth).
 - b. **Domestic Use** means use of the Product for personal, domestic or household purposes.
 - c. **Kleenmaid** means Compass Capital Services Pty Ltd ABN 96 138 214 525 trading as Kleenmaid.
 - d. **Mainland Australia** means the following States and Territories of Australia: New South Wales, Victoria, South Australia, Western Australia, Queensland, Tasmania, Northern Territory, Australian Capital Territory.
 - e. **Product** means the appliance sold by Kleenmaid to you as evidenced by the original purchase invoice.
 - f. **Service Agent** means any independent service agent engaged by Kleenmaid to carry out any repair or service under this warranty.
 - g. **Warranty Period** means for domestic use and for Products purchased on or after 1 January 2019 the period of 60 months, otherwise 36 months. For non-domestic use 12 months or such alternative period as may be specified.

UPDATE NOTICE: This Kleenmaid Warranty is current as at 1 December 2022 but is subject to variation from time to time. For the latest version of the Kleenmaid Warranty, please see our website <https://kleenmaid.com.au/warranty/> or phone us on (02) 9310 1207.

This page intentionally left blank.

Other products available in the Kleenmaid range of appliances

- | Washing machines
- | Clothes dryers
- | Dishwashers
- | Ovens
- | Cooktops
- | Steam ovens
- | Microwave ovens
- | Built in espresso coffee machines
- | Rangehoods
- | Freestanding ovens
- | Refrigerators & Freezers
- | Beverage Serving Cabinets
- | Water Dispensers
- | Vacuum Cleaners

To register your warranty or make a warranty claim, scan this QR code:



Compass Capital Services Pty Limited
trading as Kleenmaid
ABN 96138214525

Level 2, 204 Botany Road Alexandria
NSW 2015



Register your Kleenmaid
Appliances Warranty
www.kleenmaidwarranty.com.au



Request a Warranty Service
www.kleenmaidwarranty.com.au

E: warranty@kleenmaid.com.au

Please download the current User Manual for this
appliance at www.kleenmaid.com.au

 **kleenmaid**