

USER MANUAL

INALTO[®]

INALTO.HOUSE

60cm Single Dishwasher Drawer

MODEL CODE/S

IDWD60SS



A HIGHER LEVEL OF WASHING

Welcome!

Residentia Group Pty Ltd

ACN. 600 546 656
165 Barkly Avenue
Burnley, Victoria
Australia 3121

—

Applico Ltd

635 Great South Road
Penrose, Auckland 1061
New Zealand

Congratulations on purchasing your new appliance!

The InAlto brand is proudly distributed within Australia by Residentia Group Pty Ltd and within New Zealand by Applico Ltd.

Please refer to the warranty card at the rear of this manual for information regarding your product's parts and labour warranty, or visit online at:

www.residentia.group
www.applico.co.nz
www.inalto.house

Both Residentia Group & Applico are customer obsessed and our Support Teams are there to ensure you get the most out of your appliance. Should you want to learn more about recommended usage, the various features of your appliance, and importantly taking care of the unit when cleaning, our Support Teams are here to help.

Telephone Contacts:

AU: 1300 11 4357
NZ: 0800 763 448

It is important that you read through the following use and care manual thoroughly to familiarise yourself with the installation and operation requirements of your appliance to ensure optimum performance.

Again, thank you for choosing an InAlto appliance and we look forward to being of service to you.



**A RESIDENTIA
GROUP INITIATIVE**

Contents	Page
Welcome	2
Quick Start Guide	4
Safety Instructions	6
Installation Instructions	10
Your InAlto Dishwasher	16
Using Your Dishwasher	20
Operation Instructions	28
Maintenance & Cleaning	31
Troubleshooting	35
Product Specifications	38
Purchase Details	39
Your Receipt	39
Warranty	40

Quick Start Guide

Starting A Wash



1 Discard scraps
Scrape large food particles off and remove any foreign objects.

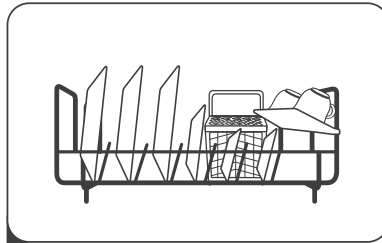

2 Load dishes carefully
For better washing result, place the dishes properly avoiding any contact or overlapping between them.

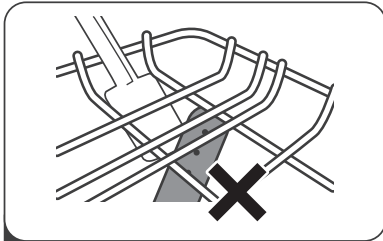

3 Check spray arm
Ensure there are no items blocking the spray arm from rotating.

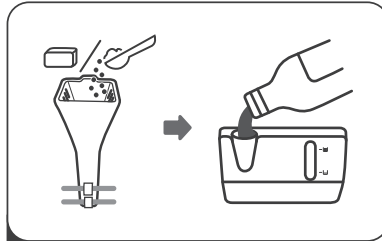

4 Add detergent and check rinse aid
If the "☼" indicator is lit, or the rinse aid is below the minimum capacity line, please refill.



5 Set up the dishwasher function
Power the dishwasher on, then select wash program and function.

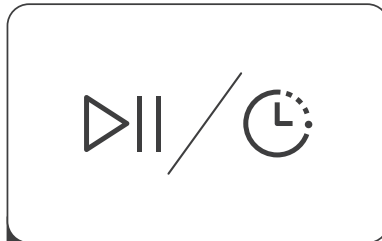

6 Start wash or set Delay start
Close the drawer and press "▶||".

• After The Wash

The drying fan may continue to run for a set time after that the washing cycle is over or until the drawer is open.

For best drying result, we recommend to unloading the dishes when they have cooled down.

NOTE:

- Reviewing the section on **TROUBLESHOOTING TIPS** will help you solve some common problems by yourself.
- If you cannot solve the problems by yourself, please ask for help from a professional technician.
- The manufacturer, following a policy of constant development and updating of the product, may make modifications without giving prior notice.
- If lost or out-of-date, you can receive a new user manual from the manufacturer or responsible vendor.

Safety Instructions

⚠ WARNING

READ ALL INSTRUCTIONS BEFORE USE

It is your responsibility to use caution when installing, maintaining, and operating your dishwasher.

We will not be liable for any damage resulting from improper use.

This is the safety alert symbol. This symbol alerts you to potential hazards that can result in property damage or serious bodily harm, even death.

The safety alert symbol will be followed by either the word "WARNING" or "CAUTION" then an important safety message. These words mean:

⚠ WARNING Indicates the possibility of serious bodily harm or death.

⚠ CAUTION Indicates the possibility of injury or damage to property.

• Basic Safety Precautions

- This appliance is intended to be used in household and similar applications such as:
 - staff kitchen areas in shops, offices and other working environments;
 - farm houses;



- by clients in hotels, motels and other residential type environments;
- bed and breakfast type environments.
- This appliance can be used by children aged from 8 years and above and persons with reduced physical, sensory or mental capabilities or lack of experience and knowledge providing they have been given supervision or instruction concerning use of the appliance in a safe way and understand the hazards involved.
- Children should not play with the appliance. Cleaning and user maintenance should not be done by children without supervision.
- This appliance is not intended for use by persons (including children) with reduced physical, sensory or mental capabilities, or lack of experience and knowledge, unless they have been given supervision or instruction regarding the use of the appliance by a person responsible for their safety.
- Packaging material could be dangerous for children!
- This appliance is for indoor household use only.
- To protect against the risk of electrical shock, do not immerse the unit, cord or plug in water or other liquid.
- Unplug before cleaning and performing maintenance on the appliance.
- Do not put downward force on either opened drawer prior to the dishwasher being fully installed. It will be unstable and may tip forward.

Safety Instructions (Continued)

- Do not use the dishwasher before it is fully installed as per the Installation Instructions. It will be unstable and be likely to tip forward.
- Do not operate the dishwasher without all the enclosures fixed in place.
- The sharp edges of knives and utensils with sharp points should not face upwards.
- Some dishwasher detergents are strongly alkaline. They can be extremely dangerous if swallowed. Avoid contact with the skin and eyes and keep children away from the dishwasher when the door is open.
Check that the detergent receptacle is empty after completion of the wash cycle.
The door should not be left open position since this could present a tripping hazard.
- When emptying the dishwasher, check that all the detergent has been dissolved.
- The inlet water hose supplied must be used. Do not reuse a used or old hose.
- The power cable must be safely routed. If it is ever damaged, it must be replaced with a similar item by a registered electrician.
- An earthed 3 pin socket must be used. Consult a registered electrician if there is doubt regarding the earth connection.

• Product Disposal

- The packaging can be recycled.
- If the product is to be disposed of, do this responsibly at your local Council Waste Depot.
- **DISPOSAL: Do not dispose this product as unsorted municipal waste. Collection of such waste separately for special treatment is necessary.**



Installation Instructions

• Product Dimensions

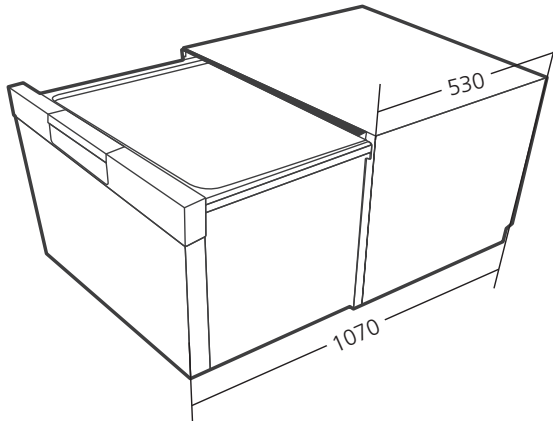
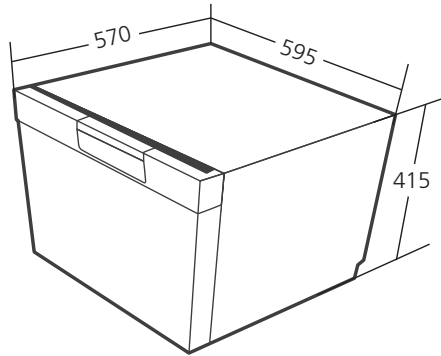

Unit: mm

Before Installation

Parts supplied

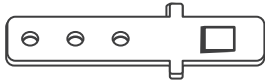

Mounting brackets (4)
(for drain hose coupling)



Ensure that the inner end of the tab is protruding by one material thickness



Screws (8)

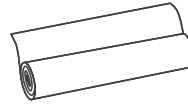

Moisture protection tape (1)

Prepare the cavity

The cavity will need to conform to the dimensions in the diagram.

The water supply and power point for the appliance cannot be in the dishwasher cavity. Ideally they should be in an adjacent cavity, easily accessed for isolating the product.

An opening to allow the hoses and power cord to exit is required on either side of the cavity with the minimum dimensions shown.

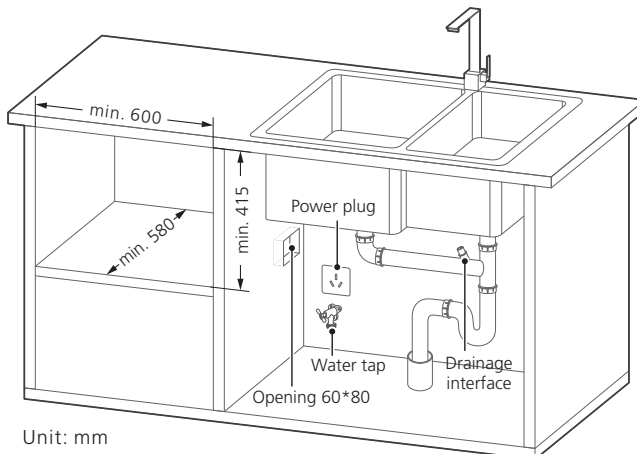

Unit: mm

Installation Instructions (Continued)

Prepare the cavity

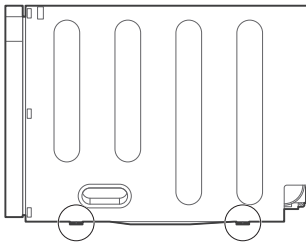

Dishwasher must be level for proper dish rack operation and wash performance.

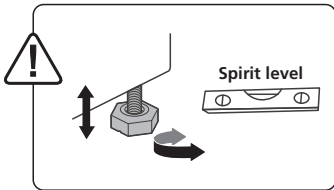

If need be, adjust the feet in each corner to ensure the product sits evenly on the floor, and is level both left to right and front to back. This can be checked by using a spirit level on an open drawer.

Installing Your Dishwasher

Cold water connection

The Inlet Hose supplied requires a 3/4 inch BSP Male fitting, suitable for a flat sealing washer.

A faucet is important for isolating the supply to the dishwasher.

Ensure that the sealing washer supplied inside the hose connection is firmly in place.

Check that the initial water is clean, particularly if the supply has not been used for some time.

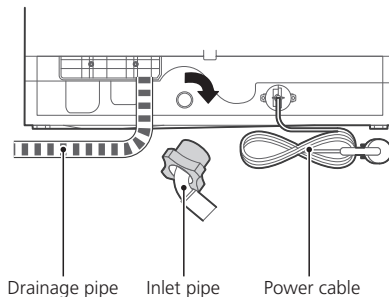
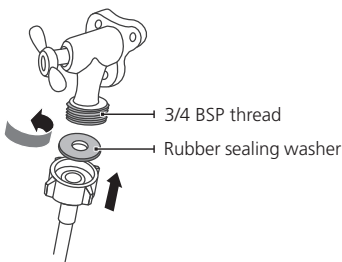

Drainage pipe Inlet pipe Power cable

Fit the mounting brackets

Drawer dishwashers are unstable until they are secured to their surrounding cabinetry. Study the two options for securing offered and choose one that suits your cabinetry. Fit the mounting brackets supplied to the top or sides of the product, ensuring the locking tab effectively retains the bracket in place. Adjust the tabs if needed. With the aid of pliers pre form the bracket to match the surface it will be fitted to. Shorten the tab if needed.

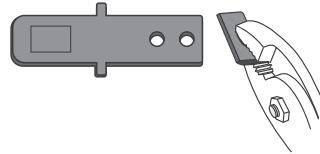
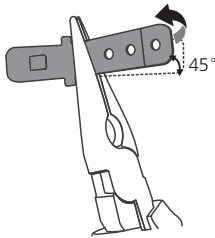

Installation method (A) Attach top mounting brackets

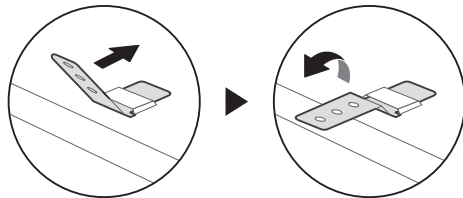
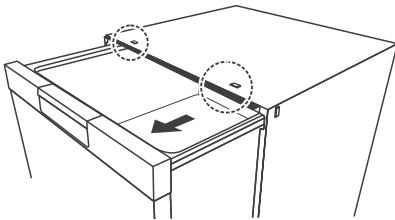

Installation method (B) Attach side mounting brackets

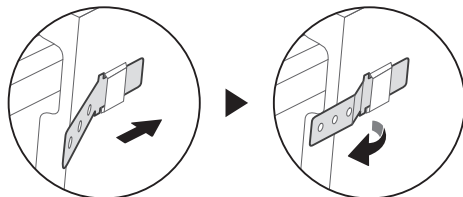
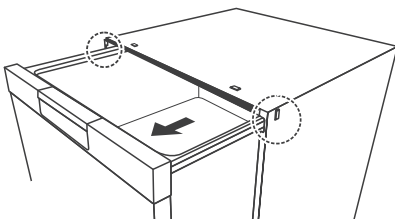

Installation Instructions (Continued)

Fit the dishwasher

Position the dishwasher in the cavity so the the drawer fronts are in line with the adjacent cabinetry.

Draw the hoses and power cord through the their opening as you slide the product in.

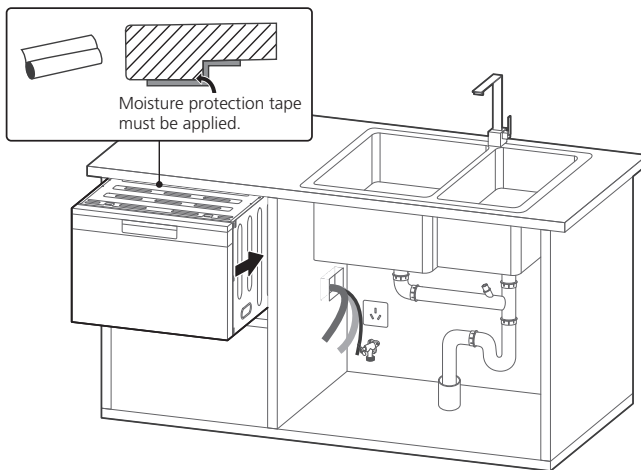

Connection of the drain hose

There are two recommended options for connecting the drain hose.

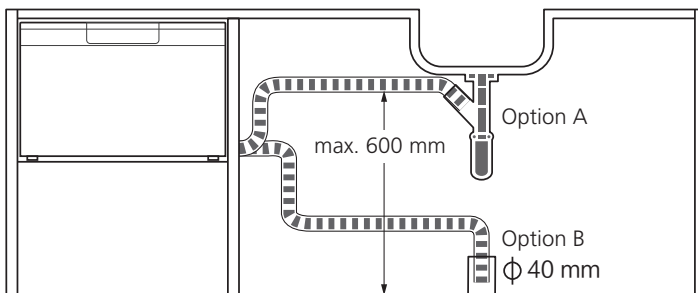

⚠ CAUTION

- Drainage pipe length should not exceed 5 meters.
- Please try to run the dishwasher first, confirm that the machine can be used properly before fixing, so as to avoid unnecessary repetition of disassembly and assembly.

Secure the product in place

With suitable fasteners, fix the mounting brackets to the cabinetry.

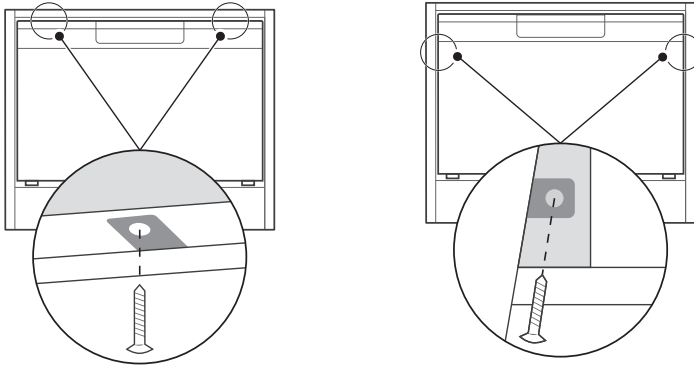

Electrical Requirements

WARNING



Electrical Shock Hazard

Disconnect electrical power before installing dishwasher.
Failure to do so could result in death or electrical shock.

Attention

The installation of the pipes and electrical equipments should be done by professionals.

The dishwasher requires a 220-240 Volt 50 Hz AC supply through a 10 amp rated power outlet.

Ensure that the supply is properly earthed.

Your InAlto Dishwasher

❗ IMPORTANT:

To get the best performance from your dishwasher, read all operating instructions before using it for the first time.

Product Overview

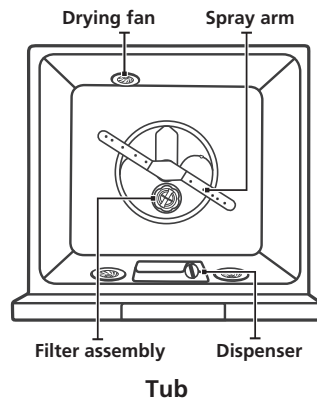
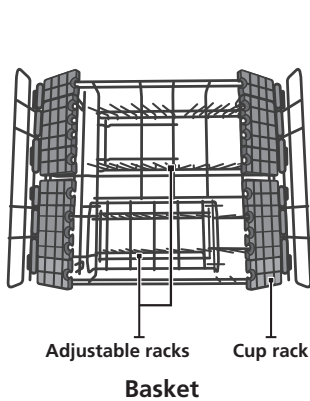
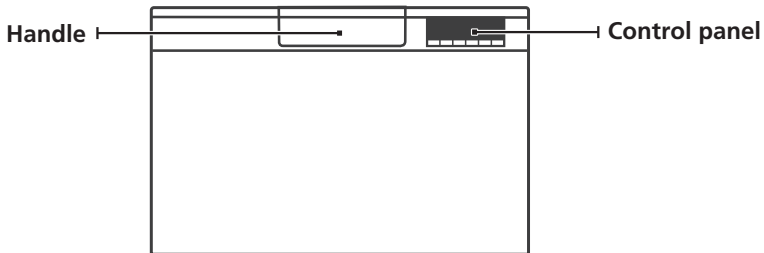

Cutlery basket



Detergent chute

Control Panel

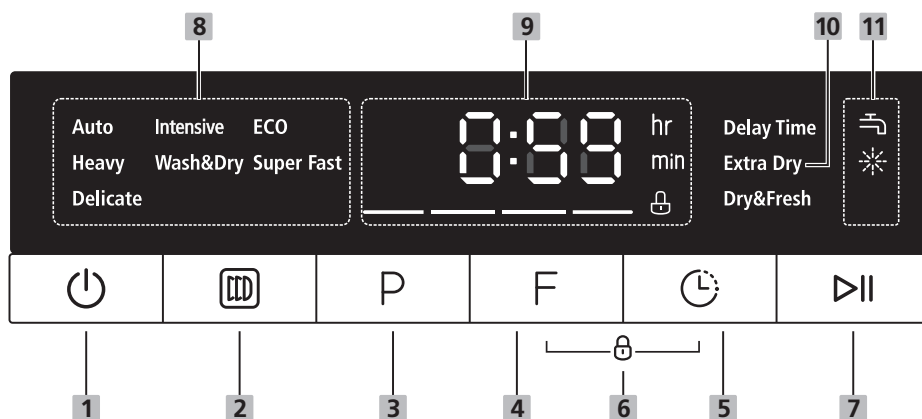

Operation (Button)

1 Power	Press this button to turn on your dishwasher, the screen will light up.
2 Dry&Fresh	For removing bad odor and moisture even when dishes are left longer time in the baskets. A) when selected this option will start to run at the end of the washing cycle, its indicator will blink. B) Press and hold the Option button for 3s, when dishwasher is on, for let the option run immediately.
3 Program selector	Press this button to select the appropriate washing program, the selected program indicator will light up.
4 Function selector	Press the button to select the Function selector, the indicator (Extra Dry) will be lit.
5 Delay start	Press the button to increase the delay start time. Delay a cycle for up to 24 hours in one-hour increments. After setting the delay time, press the Start/Pause button to start.



Your InAlto Dishwasher (Continued)

<p>6 Child lock</p>	<p>This option allows you to lock the buttons on the control panel, so children cannot accidentally start the dishwasher by pressing the buttons on the panel. Only the Power button remains active. To lock or unlock the buttons on the control panel, press and hold the Option button+ Delay button for 3 seconds simultaneously.</p>
<p>7 Start/Pause</p>	<p>To start the selected washing program or pause it when the dishwasher is operating. When the dishwasher is running, if you need to open the drawer, please press the "Start/Pause" button first and wait a few seconds, then open the door slowly.</p>

Display

<p>8 Washing program</p>	<p>Auto Auto sensing wash, lightly, or heavily soiled crockery, with or with out dried-on food.</p> <p>Intensive For heaviest soiled crockery, such as pots, pans, casserole dishes and dishes that have been sitting with dried food on them for some time.</p> <p>ECO For normally soiled loads, such as pots, plates, glasses and lightly soiled pans, standard everyday cycle.</p> <p>Heavy For heavily soiled loads, such as pots, plates, glasses and lightly soiled pans.</p> <p>Wash&Dry For lightly soiled plates and pans that need a quick wash.</p> <p>Super Fast A shorter wash for lightly soiled loads that do not need drying.</p> <p>Delicate For fragile items such as fine china and glassware.</p>
---------------------------------	---

Display

9 Screen	Show the operating drawer, time reminding, delay time, error code etc, child lock indication.
10 Extra Dry	For better drying result. (It can only be used with Intensive, ECO, Heavy, Wash&Dry, Delicate)
11 Warning	<p>Water Supply Failure If the “” indicator is lit, it means that no water is reaching the dishwasher.</p> <p>Rinse Aid If the “” indicator is lit, it means the dishwasher is low on dishwasher rinse aid and requires refilling.</p>

Washing progress

Main-wash	
Rinse	
Drying	
End	

Using Your Dishwasher

Before using your dishwasher :

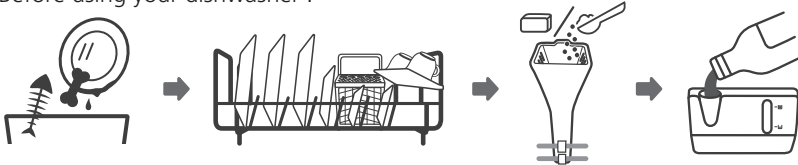

1. Removing the larger residue off the wash items
2. Loading the basket
3. Loading the detergent
4. Filling the rinse aid dispenser

Basket Use Tips

There are many ways to adjust the loading pattern of the basket.

Removing the rear rack

The rear rack can be removed to create a flat surface for such things as pots and pans.

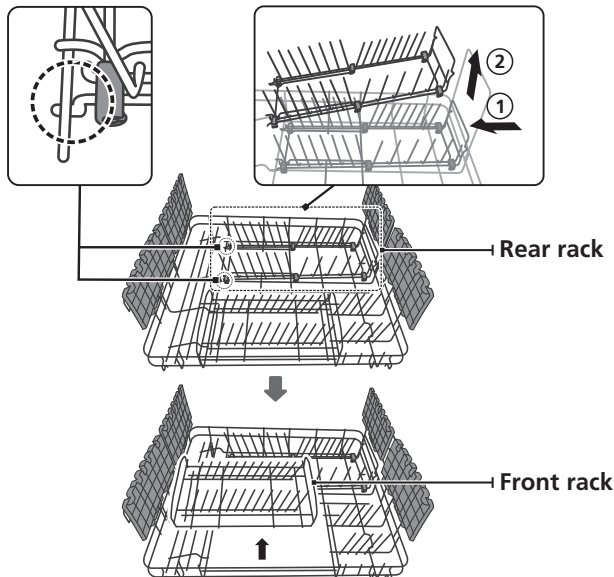

Folding down the pins

- The spacing between the pins can be increased by folding them down. This will help the loading of large bowls and deep pot and pans. Folding down the pins, the maximum size 290mm plates can be loaded..
- The pins on the front rack can also be folded down to create a flat space. Do not load the basket with the front rack removed. It is removable only to allow access to the filters for servicing. The risk is too great because item could fall in the open space and damage the rotating spray arm.
- If returning the rear rack, be sure to firmly set it into it's correct place.

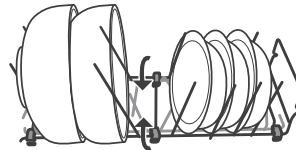
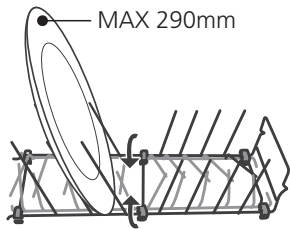
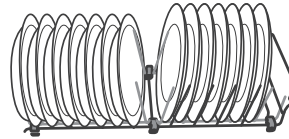
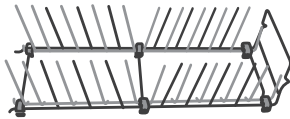

Using the cup racks

Cups and glasses and large utensils fit on the cup racks. The fronts of the racks are designed to secure wine glasses.

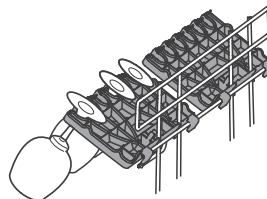
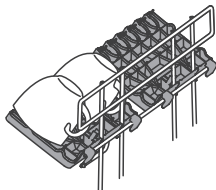

Using Your Dishwasher (Continued)

Adjustable the cup racks

You can adjust these cup racks to different heights independently:

1. Fold the cup racks if you need more space.
2. Remove the cup holder and install it on a iron wire of different height to adjust the height of the cup holder.

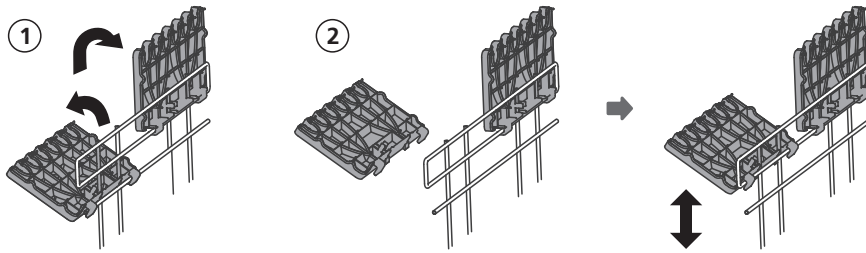

Two positions cutlery basket

The cutlery basket is made in two halves.

The cutlery basket is composed by two foldable half.

Is possible to used it open or fold as in the drawing.

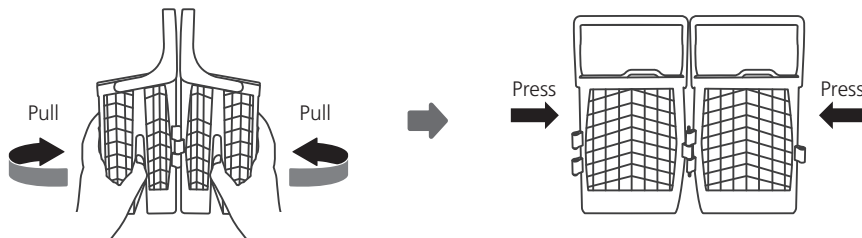

You can use the cutlery basket with the cover open.



• **Preparing And Loading Dishes**

- Consider buying utensils which are identified as dishwasher-proof.
- For particular items, select a program with the lowest possible temperature.
- To prevent damage, do not take glass and cutlery out of the dishwasher immediately after the program has ended.

For washing the following cutlery/dishes

Are not suitable

- Cutlery with wooden, horn china or mother-of-pearl handles
- Plastic items that are not heat resistant
- Older cutlery with glued parts that are not temperature resistant
- Bonded cutlery items or dishes
- Pewter or copper items
- Crystal glass
- Steel items subject to rusting
- Wooden platters
- Items made from synthetic fibres

Are of limited suitability

- Some types of glasses can become dull after a large number of washes
- Silver and aluminum parts have a tendency to discolor during washing
- Glazed patterns may fade if machine washed frequently

Recommendations for loading the dishwasher

Scrape off any large amounts of leftover food. Soften remnants of burnt food in pans. It is not necessary to rinse the dishes under running water.

For best performance of the dishwasher, follow these loading guidelines.

Place objects in the dishwasher in following way:

- Items such as cups, glasses, pots/pans, etc. are faced downwards.
- Curved items, or ones with recesses, should be loaded on a slant so that water can run off.
- All utensils are stacked securely and can not tip over.
- Be sure that no wash items protrude through the basket base where they will likely foul the spray arm.
- Load hollow items such as cups, glasses, pans etc. With the opening facing downwards so that water cannot collect in the container or a deep base.
- Dishes and items of cutlery must not lie inside one another, or cover each other.

Using Your Dishwasher (Continued)

- To avoid damage, glasses should not touch one another.
- Please do not overload your dishwasher. This is important for good results and for reasonable consumption of energy.

NOTE:

Very small items should not be washed in the dishwasher as they could easily fall through the basket.

CAUTION



Items will be hot! To prevent damage, do not take glass and cutlery out of the dishwasher for around 15 minutes after the program has ended.

Loading the dishwasher

The loading pattern in the illustration is recommended for the design of basket. It is the pattern used for the Standards Wash Test (AS/NZS 2007.1).

NOTE:

Cups and glasses face downwards.
Plates face the back of each other, as do side plates, soup plates and saucers.

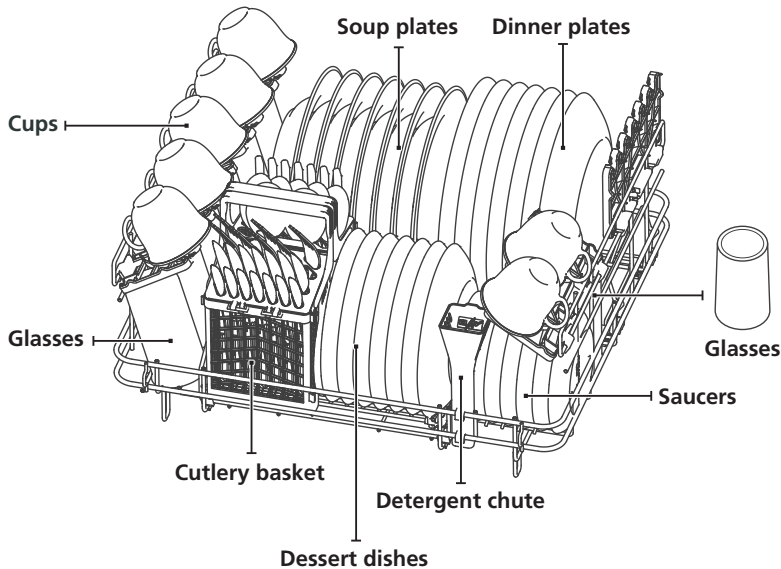



Loading the cutlery basket

You can place each knife, spoon, or fork separately into the spoon stands in the basket's covers to prevent chipping and discoloration.

The spoon stands as seen from above with the suggested placement of cutlery items. Match the numbers in the diagram to the numbers in the list of cutlery items above.

⚠ WARNING



Always load sharp utensils with the sharp point down!
Do not let any item extend through the bottom.

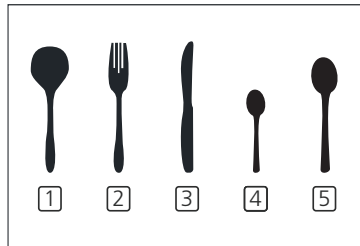
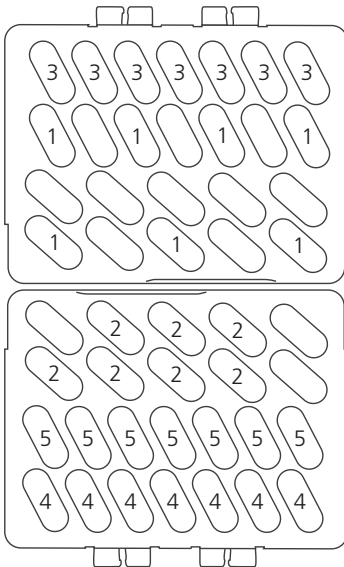

Number	Item
1	Soup spoons
2	Forks
3	Knives
4	Teaspoons
5	Dessert spoons

Settings for Standards Wash Test AS/NZS 2007.1

Capacity: 7 place settings

Wash Program: ECO

Detergent quantity: 23.75g

Rinse Aid setting: **D5**

Using Your Dishwasher (Continued)

To shorten the drying time, the drawer can be opened approx 150 mm at the end of the wash cycle and lasts 40 minutes. This however is not compulsory. The wash load will dry completely given the drying time suggested in the table on page 21

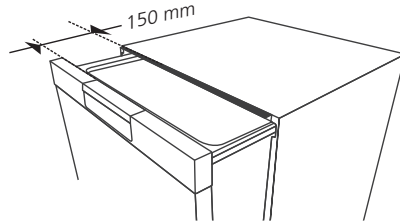

Adding Detergent

The chemicals in Dishwasher Detergent are necessary to remove, dissolve and help dispose of all the soils from the wash load.

Only specific Electric Dishwasher Detergent is capable of doing this.

⚠ WARNING

- Dishwasher detergent is dangerous. Avoid skin and eye contact
- Keep the dishwasher detergent out of reach of children.
- Keep it sealed in a dry place.

Add the recommended quantity of detergent to the detergent chute on the basket.



Adding Rinse Aid

Rinse Aid is added during the final rinse to assist the wash load drying and to prevent spots and streaks on glassware.

For guaranteed excellent drying results, always use a branded Rinse Aid. No other products are suitable.

Filling the Rinse Aid Dispenser

Refill the dispenser when either the level is at the low level mark by the indicator window, or when the display indicate the rinse aid symbol ().

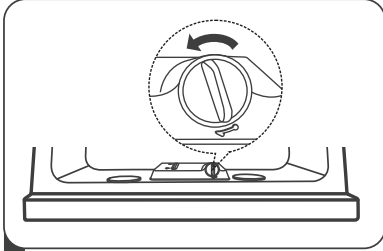

- 1 Undo the plug by turning it anticlockwise.

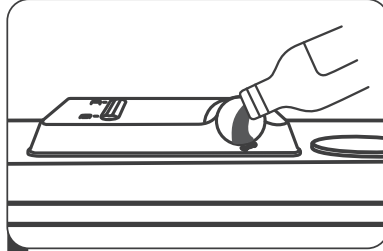

- 2 Fill the dispenser slowly to avoid spillage. Each dispenser will take 300ml from empty.

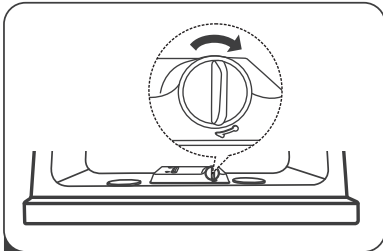

- 3 Close the plug by rotating it clockwise.

NOTE:

It is important to clean up any spills rinse aid, as it will cause excessive foaming in the wash cycle.

Adjusting the rinse aid dispenser

To achieve the best drying result, with the least amount of rinse aid being used, the dispenser can be adjusted by the user.

There are 5 levels of adjustment, the factory setting is **D5**. This setting will provide excellent drying results.

If the dishes are not drying properly or with cloudy stains, the setting of D4 or D5 will be required.

If there are sticky whitish stains on your dishes or a bluish film on glassware or knife blades, the dispenser can be set back to either D2 or D1 to reduce any unnecessary waste of rinse aid, whilst maintaining excellent drying results.

Follow the steps below:





1. Switch on the dishwasher by press the Power button.
2. Within 60 seconds after step 1, press the Start/Pause button more than 5 seconds, the rinse aid indication blinks.
3. Press the Start/Pause button to select the proper set according to your using habits, the sets will change in the following sequence: D1->D2->D3->D4->D5->D1.
4. Without any operations in 5 second, or exit the set mode through the power button, the new setting is active.

Operation Instructions

Wash Cycle Table

The table below shows which programs are best for the levels of food residue on them and how much detergent is needed. It also show various information about the programs.

(●)Means: need to fill rinse into the Rinse-Aid Dispenser.

Program	Water temp (°C)	Detergent required grams or tablets	Running Time (min)	Energy usage (Kwh)	Water usage (L)	Rinse Aid
 Auto	Auto wash (45-50°C) Rinse Rinse (50°C) Auto Rinse (60-70°C) Drying	$\frac{23.75g}{1 \text{ piece}}$	150	0.5-1	6-9	●
 Intensive	Wash (65°C) Rinse Rinse (45°C) Rinse (65°C) Drying	$\frac{23.75g}{1 \text{ piece}}$	140	0.85	11.5	●
ECO (*AS/NZS 2007.1)	Wash(45°C) Rinse Rinse Rinse(45°C) Drying	$\frac{23.75g}{1 \text{ piece}}$	170	0.34	6.6	●
 Heavy	Wash(60°C) Rinse Rinse Rinse(60°C) Drying	$\frac{23.75g}{1 \text{ piece}}$	120	0.6	8	●
 Wash&Dry	Wash (55°C) Rinse (55°C) Rinse (55°C) Rinse (55°C) Drying	$\frac{23.75g}{1 \text{ piece}}$	58	0.55	11	●
 Super Fast	Wash (50°C) Rinse (55°C)	$\frac{23.75g}{1 \text{ piece}}$	29	0.2	4	○

Program	Water temp (°C)	Detergent required grams or tablets	Running Time (min)	Energy usage (Kwh)	Water usage (L)	Rinse Aid
 Delicate	Wash (50°C)	23.75g	85	0.45	8.5	●
	Rinse					
	Rinse	1 piece				
	Rinse (55°C)					
	Drying					

NOTE:

AS/NZS 2007.1: This program is the test cycle. The information for comparability test in accordance with AS/NZS 2007.1.

Starting A Cycle Wash

1. Close the drawer, press the Power button to switch on the machine.
2. Press the Program button to select the desired program.
3. Press the Start/Pause button, the dishwasher will start its cycle.

Changing The Program Once Started

A wash program can only be changed if it has not been running long. You need to ensure that the wash water is still present and it has not drained out and began rinsing. Detergent will have to be re added if there is no wash water present.

Here are the instructions to change the program:

1. Press the Start/Pause button to pause the washing.
2. Press the Program button for more than 3 seconds, the program will be cancelled.
3. Press the Program button to select the desired program.
4. Press the Start/Pause button, the dishwasher will start.

Operation Instructions (Continued)

Adding Items While A Wash Is In Progress

You can add items after the wash program has begun.

However if it is no longer in the wash cycle, anything added may not be well washed, and other items soiled as well. Check that it is not rinsing.

Follow these instructions:

1. Press the Start/Pause button to pause the washing.
2. Wait 5 seconds then open the drawer.
3. Add the extra items.
4. Close the drawer.
5. Press the Start/Pause button, the dishwasher will start.

⚠ CAUTION

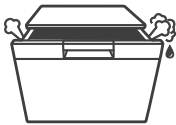

It is dangerous to open the drawer mid-cycle, as hot steam may scald you.

💡 NOTE:

- When the dishwasher is operating, do not force open the drawer, press the Start/Pause button, and wait a few seconds before opening the drawer.
- If the electric power to the dishwasher is interrupted during a wash program, it will continue to the end of the program when the power is restored.

Maintenance & Cleaning

Keeping your dishwasher clean improves its performance, reduces unnecessary repairs, and lengthens its life.

⚠ WARNING

Disconnect the dishwasher from the power supply (unplug or switch off at the circuit breaker) and allow all its parts to cool before any cleaning or maintenance.

External Care

It's best to clean spills on the outside of your dishwasher as they occur. Use a soft, damp cloth on the control panel to gently wipe away spills and dust. Do not use benzene, wax, thinner, chlorine bleach, or alcohol. These materials may discolor the inner walls and cause stains. Do not clean the dishwasher by sprinkling water over it and avoid letting water come into contact with any of the electrical parts.

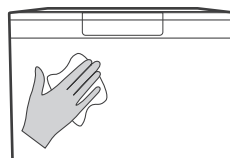

💡 NOTE:

If your dishwasher has a stainless steel door panel, you can clean it with a stainless steel cleaner for home appliances or a similar product using a clean, soft cloth.

Internal Care

Filtering system

The filtering system in the base of the wash cabinet traps coarse debris from the washing cycle. The collected coarse debris may cause the filters to clog. Check the condition of the filters regularly and clean them if necessary under running water. Follow the steps below to clean the filters.

⚠ CAUTION

- Do not over tighten the filters. Put the filters back in sequence securely, otherwise coarse debris could get into the system and cause a blockage.
- NEVER use the dishwasher without filters in place. Improper replacement of the filter may reduce the performance level of the appliance and damage dishes and utensils.

Maintenance & Cleaning (Continued)

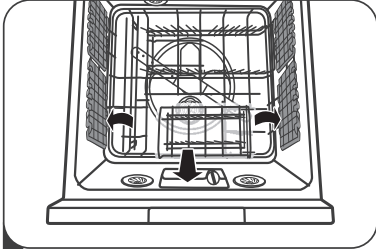

1 Lift up the handles and remove the plate support

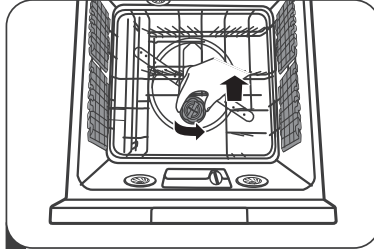

2 Rotate the Cylinder filter counter-clockwise. Lift the Cylinder filter upwards and out of under the basket.

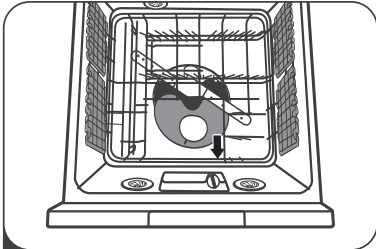

3 Pull forward the Fine filter.

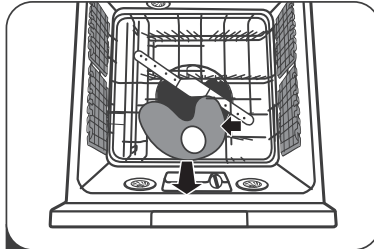

4 Tilt the Fine filter and remove it from under the basket.

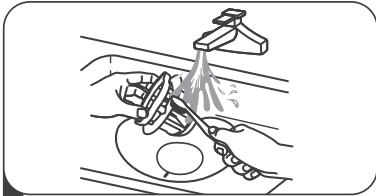

5 Rinse with running water. For a more thorough clean, use a soft cleaning brush.

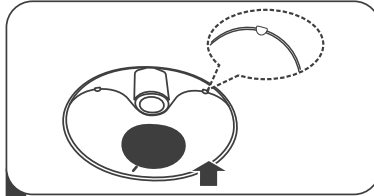

6 Reinstall the filters in reverse order making sure the Fine filter locks into place.

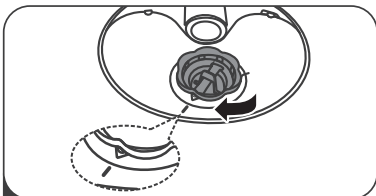

7 Rotate the Cylinder filter clockwise to the close arrow.

Spray arms

If you are in a hard water area, it is necessary to clean the spray arms regularly for hard water chemicals will clog the spray arm jets and bearings.

To clean the spray arms, follow the instructions below:

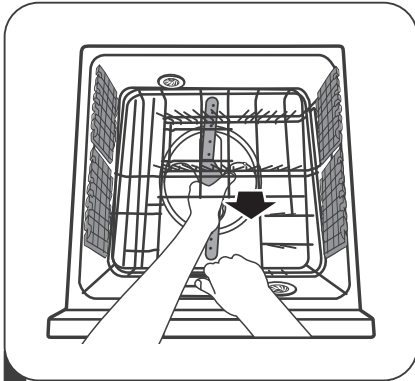

- 1** One hand raised the basket slightly, and the other hand reached under the basket. Hold the spray arm and lift it up.

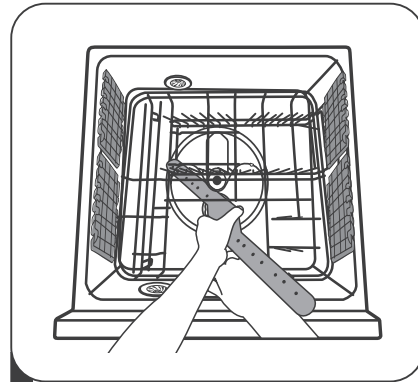

- 2** Slightly tilt the arm and remove it from under the basket.

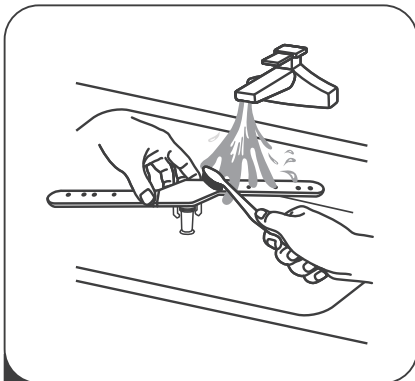

- 3** Wash the arms in soapy and warm water and use a soft brush to clean the jets.
After cleaning, replace it in the opposite direction.

Maintenance & Cleaning (Continued)

Caring For The Dishwasher

Frost precaution

If you live in a region that is where the inside temperature can drop below zero, care needs to be taken to avoid possible damage if the water in the dishwasher freezes.

1. Turn off the mains power to the dishwasher.
2. Turn off the water supply and disconnect the Water Inlet Hose. Drain the water inside the hose then reconnect.
3. Remove the coarse filters in the tubs and soak up all water possible with a sponge. Then re-assemble.

Cleaning

Only use gentle cleaning products on the exterior of the dishwasher, no solvents or abrasive compounds.

Products specifically for cleaning the stainless steel interior are effective in restoring the original bright interior.

Long term storage

Disconnect the power supply and the water supply.

Remove the coarse filters and soak up all water possible with a sponge.

This reduces the chance of any odors developing inside the tubs.

Troubleshooting

Before Calling For Service

Before calling for service, check the following list for problems probable causes and what you can do.

Problem	Possible Causes	What To Do
Dishwasher won't start	No power.	Check that the power cord is plugged in to a live powerpoint and it is turned on.
	No water supply.	Check that the hose is connected to a water supply and it is turned on.
There is water remaining in the tub	Kinked or blocked drain hose.	Check the drain hose routing.
	Clogged filters in the tub.	Check the filters. If they are clogged, remove them carefully to avoid dropping anything into the sump that could cause a blockage.
The wash items are not clean	Incorrect wash program chosen.	Select a more intensive program
	Obstacle obstructing the spray arm from turning.	Check the washload for items protruding through the bottom of the basket, or if an item has fallen through the basket.
	Loading pattern too tight	Check for adequate spacing between items.
	Filters not correctly in place.	If either filter is found to be out of place, also check spray arm for blockages.
	Blocked spray arm.	Check that the holes in the spray arm are all clear. Back flush with water to clear.
	Insufficient detergent loaded.	Increase detergent quantity

Troubleshooting (Continued)

Problem	Possible Causes	What To Do
Wash items are not fully dry	Unloading dishwasher too soon.	The drying cycle must be complete before the dishwasher is unloaded. Check the Display for end time.
	Insufficient Rinse Aid.	Check for Low Rinse Aid Level warning and re fill if necessary.
	Rinse Aid setting too low.	Increase Rinse Aid setting as per instructions on page 20
Glassware developing cloudy stains and calcium rings	Insufficient Rinse Aid being dispensed.	Adjust the Rinse Aid Dispenser as per the instructions on page 20
Wash items showing signs of rust	Items are unsuitable for dishwasher use.	Discontinue washing such items in the dishwasher.
Tub becoming dull in color	Tub requires rejuvenation.	Dose the tub with specific Stainless Steel Tub /Bowl Cleaner.
Traces of detergent in the tub	Incomplete/interrupted wash cycle.	Rerun wash program to ensure wash load is not contaminated with detergent.
Foam in the wash tub	Non electric dishwasher detergent used.	Use correct detergent.
	Spilt Rinse Aid present.	Repeat the Rinse Program until clear.

Error Codes

If there is a malfunction, the dishwasher will display error codes to identify the symptom.

Codes	Meanings	Possible Causes
E1	Extended Water Inlet Time.	Water supply failure, closed faucet, or insufficient supply water pressure.
E3	Water temperature not reaching target.	Heating element malfunction.
E4	Leak Detected.	For some reason water has leaked from the wash system. Possibilities are over height item in the washload stopping lid from sealing; internal plumbing or seal failure.
Ec	Washing Control System failure.	Electronics or Motor failure.
Ed	Failure of connection between Display Unit and the Control System.	Wiring failure between the two devices.
EH	The cover does not open or close properly.	The cover motor device damage or foreign matter stuck.

Product Specifications

Model:	IDWD60SS
Product Type:	Single Dishwasher Drawer
Standard Place Settings:	7
Energy Efficiency:	3.5 (MEPS)
Water Consumption	4.5 (WELS)
Standard Cleaning Cycle:	ECO
Energy Consumption of the Standard Cleaning Cycle	0.34 kWh
Water Consumption of the Standard Cleaning Cycle	6.6 litres
Program Duration of the Standard Cleaning Cycle	170 minutes
Noise Level	47 dB(A) re 1 pW
Mounting	Built-in
Power Consumption	965-1140 W
Rated Voltage/Frequency	AC 220-240V/ 50Hz
Water Supply Pressure:	0.04-1.0 MPa=0.4-10 bar
Product Dimensions (W, D, H):	595mm, 570mm, 415mm
Cavity Dimensions (W, D, H):	600mm minimum, 580mm minimum, 415mm minimum
Width with Drawer Opened:	1070mm



Purchase Details

For future reference, please record the following information which can be found on the rating plate and the date of purchase which can be found on your sales invoice.

STORE DETAILS

STORE NAME | _____

ADDRESS | _____

TELEPHONE | _____

PURCHASE DATE | _____

PRODUCT DETAILS

MODEL NO. | _____

SERIAL NO.* | _____

Attach your receipt
to this page



Warranty Information

AUSTRALIAN WARRANTY TERMS & CONDITIONS DISHWASHER DRAWERS

This document sets out the terms and conditions of the product warranties for Residentia Group Appliances. It is an important document. Please keep it with your proof of purchase documents in a safe place for future reference should you require service for your Appliance.

1. IN THIS WARRANTY

- (a) 'acceptable quality' as referred to in clause 10 of this warranty has the same meaning referred to in the ACL;
 - (b) 'ACL' means Trade Practices Amendment (Australian Consumer Law) Act (No.2) 2010;
 - (c) 'Appliance' means any Residentia Group product purchased by you accompanied by this document;
 - (d) 'ASR' means Residentia Group authorised service representative;
 - (e) 'Residentia Group' means Residentia Group Pty Ltd of 118 Campbell St, Collingwood VIC, ACN 600 546 656 in respect of Appliances purchased in Australia;
 - (f) 'major failure' as referred to in clause 10 of this warranty has the same meaning referred to in the ACL and includes a situation when an Appliance cannot be repaired or it is uneconomic for Residentia Group, at its discretion, to repair an Appliance during the Warranty Period;
 - (g) 'Warranty Period' means:
 - (i) where the Appliance is used for personal, domestic or household use (i.e. normal single family use) as set out in the instruction manual, the Appliance is warranted against manufacturing defects for 24 months, following the date of original purchase of the Appliance;
 - (h) 'you' means the purchaser of the Appliance not having purchased the Appliance for re-sale, and 'your' has a corresponding meaning.
2. This warranty only applies to Appliances purchased and used in Australia and is in addition to (and does not exclude, restrict, or modify in any way) any non-excludable statutory warranties in Australia.
 3. During the Warranty Period Residentia Group or its ASR will, at no extra charge if your Appliance is readily accessible for service, without special equipment and subject to these terms and conditions, repair or replace any parts which it considers to be defective. Residentia Group or its ASR may use remanufactured parts to repair your Appliance. You agree that any replaced Appliances or parts become the property of Residentia Group. This warranty does not apply to light globes, batteries, filters or similar perishable parts.
 4. Parts and Appliances not supplied by Residentia Group are not covered by this warranty.

5. You will bear the cost of transportation, travel and delivery of the Appliance to and from Residentia Group or its ASR. If you reside outside of the service area, you will bear the cost of:
- travel of an authorised representative;
 - transportation and delivery of the Appliance to and from Residentia Group or its ASR, in all instances, unless the Appliance is transported by Residentia Group or its ASR, the Appliance is transported at the owner's cost and risk while in transit to and from Residentia Group or its ASR.
6. Proof of purchase is required before you can make a claim under this warranty.
7. You may not make a claim under this warranty unless the defect claimed is due to faulty or defective parts or workmanship. Residentia Group is not liable in the following situations (which are not exhaustive):
- the Appliance is damaged by:
 - accident
 - misuse or abuse, including failure to properly maintain or service
 - normal wear and tear
 - power surges, electrical storm damage or incorrect power supply
 - incomplete or improper installation
 - incorrect, improper or inappropriate operation
 - insect or vermin infestation
 - failure to comply with any additional instructions supplied with the Appliance;
 - the Appliance is modified without authority from Residentia Group in writing;
 - the Appliance's serial number or warranty seal has been removed or defaced;
 - the Appliance was serviced or repaired by anyone other than Residentia Group, an authorised repairer or ASR.
8. This warranty, the contract to which it relates and the relationship between you and Residentia Group are governed by the law applicable where the Appliance was purchased.
9. To the extent permitted by law, Residentia Group excludes all warranties and liabilities (other than as contained in this document) including liability for any loss or damage whether direct or indirect arising from your purchase, use or non use of the Appliance.
10. For Appliances and services provided by Residentia Group in Australia, the Appliances come with a guarantee by Residentia Group that cannot be excluded under the Australian Consumer Law. You are entitled to a replacement or refund for a major failure and for compensation for any other reasonably foreseeable loss or damage. You are also entitled to have the Appliance repaired or replaced if the Appliance fails to be of acceptable quality and the failure does not amount to a major failure. The benefits to you given by this warranty are in addition to your other rights and remedies under a law in relation to the Appliances or services to which the warranty relates.
11. At all times during the Warranty Period, Residentia Group shall, at its discretion, determine whether repair, replacement or refund will apply if an Appliance has a valid warranty claim applicable to it.
12. To enquire about claiming under this warranty, please follow these steps:
- carefully check the operating instructions, user manual and the terms of this warranty;
 - have the model and serial number of the Appliance available;
 - have the proof of purchase (e.g. an invoice) available;
 - telephone the numbers shown below.
13. You accept that if you make a warranty claim, Residentia Group and its ASR may exchange information in relation to you to enable Residentia Group to meet its obligations under this warranty.

IMPORTANT

Before calling for service, please ensure that the steps in point 12 have been followed.

Telephone contact

- Service: Please call 1300 11 HELP (4357)

The Australian Consumer Law requires the inclusion of the following statement with this warranty: Our goods come with guarantees that cannot be excluded under the Australian Consumer Law. You are entitled to a replacement or refund for a major failure and for compensation for any other reasonably foreseeable loss or damage. You are also entitled to have the goods repaired or replaced if the goods fail to be of acceptable quality and the failure does not amount to a major failure.

Warranty Information

NEW ZEALAND WARRANTY TERMS & CONDITIONS DISHWASHER DRAWERS

To help care for your investment, be sure to register your appliance online. Registration will help you if you need to arrange service in the future, and serves as a record of your purchase - including critical information like model number and serial number - that you can refer to at any time.

Simply visit the below website, or ask your retailer for help: <https://inalto.house/nz/registration>

WARRANTY:

These products are covered by a warranty for a period of 24 months from the date of purchase, subject to the following conditions*. The warranty covers rectification free of charge of any fault arising from defective materials or components, or faulty workmanship or assembly.

* The conditions above mentioned are:

1. That the purchaser carefully follows all instructions packed with the product;
2. That the purchaser and/or installer carefully follows the installation instructions provided and complies with electrical wiring regulations, gas and/or plumbing codes;
3. That the purchaser carefully follows instructions provided in the owner's handbook relating to the proper use and care of the product and does not use the product for any purpose other than the domestic use for which it has been designed;
4. Commercial use of the product for professional or industrial purposes will void this warranty.;
5. That the product was purchased and installed in New Zealand;
6. That this warranty does not extend to:
 - a. optional glass lids for hobs apart from claims which relate to mechanical or physical damage thereof at the date of purchase;
 - b. 'consumable' parts such as light bulbs or filters;
 - c. damage to ceramic glass caused by liquid or solid spill-overs, lack of maintenance, or impact;
 - d. damage to surface coatings caused by cleaning or maintenance using products not recommended by the owner's handbook;
 - e. defects caused by normal wear and tear, accident, negligence, alteration, misuse or incorrect installations;
 - f. a product dismantled, repaired or serviced by any serviceman other than an authorised service agent;
 - g. a product not in possession of the original purchaser;
 - h. damage caused by power outages or surges

- i. damage caused by pests (eg. rats, cockroaches etc.)
7. That if the product is a freestanding microwave oven or small appliance it must be returned to the dealer/ retailer for servicing. These products, unless stated otherwise, have a 12 month warranty from original date of purchase with 24 months on the microwave magnetron; Waste disposers have a 12 month warranty.
8. The provision of service under this warranty is limited by a 25km boundary from the retailer where the product was purchased except for microwaves. Such travelling outside of these limits will incur commercial cost to be paid by you, regulated by the number of kilometres travelled beyond the 25km limit (50km return trip). Microwaves are to be delivered to the nearest authorised service agent by the customer.

Please refer to your user manual for any further conditions that may apply to your specific model.

Nothing herein contained shall be construed in any way as excluding or limiting your rights under the Consumer Guarantees Acts 1993.

For Service please visit www.applico.co.nz/service or contact the dealer/retailer from whom you purchased the product from or call the 0800 number listed below. If you are unable to establish the date of purchase, or the fault is not covered by this warranty, or if the product is found to be in working order, you will be required to bear all service call charges.

Registration of this warranty constitutes acceptance of the terms and conditions of this warranty.

Should you require any assistance, please call Customer Services on 0800 763 448.

Distributed by Applico Ltd.
www.applico.co.nz
July 2019

After registering your appliance online, we recommend you fill out the below information for your reference and keep this warranty card in a safe place.

THIS WARRANTY IS VALID IN NEW ZEALAND ONLY.



THIS PAGE IS INTENTIONALLY LEFT BLANK

A HIGHER LEVEL

INALTO?

OF WASHING

A RESIDENTIA
GROUP INITIATIVE



VERSION
1.0