

# Quick User Manual

## HWFV8012/HWVF8012S/HWVF8012T/ HWFM8012/HWFM8012S/HWFM8012T

This washing machine is equipped with automatic safety functions which detect and diagnose at an early stage and react appropriately.

- A. "Start/Pause" button
- B. "Options" button
- C. "Delay End" button
- D. "Spin" button
- E. "Temp." button

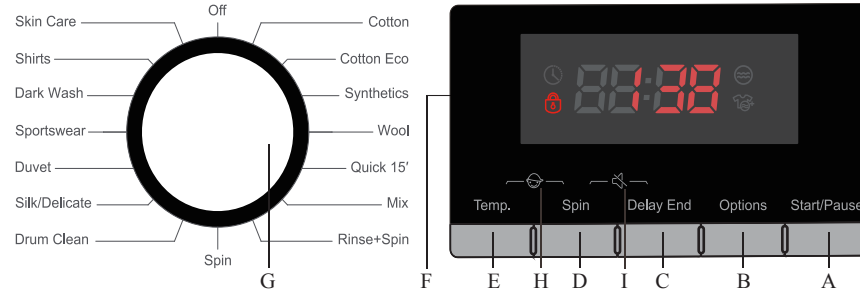

# Hisense

- F. Program and function status display window
- G. Program selector
- H. Child Lock Function
- I. Mute Function

Program	Care Label	Material / Level of Soiling	Maximum Wash Load kg	Detergent Compartmentt			Wash Program Functions					Maximum spin speed rpm	
				Prewash	Main wash	Softener	Delay End	Prewash	Extra rinse	Default rinse times	Spin		Temp.
-Washing temperature selected as per the Care Label instruction.													
Cotton --,20°C, 30°C, 40°C, 60°C, 95°C		Heavily and moderately soiled cotton, or linen. For very heavily soiled items select the "Prewash" function.	8.0	*	Yes	*	*	*	*	2	*	*	1200
Cotton Eco (1) --,20°C, 30°C, 40°C, 60°C, 95°C		Eco wash for cotton and linen. Can reduce washing time and power consumption.	8.0	*	Yes	*	*	—	*	2	*	*	1200
Skin Care --,20°C, 30°C, 40°C		Extra rinse time. Making sure no residual detergent on textiles to protect skin form irritability.	4.0	*	Yes	*	*	*	*	4	*	*	1200
Synthetics --,20°C, 30°C, 40°C, 60°C		Moderately soiled synthetics, cotton blended fabrics.	4.0	*	Yes	*	*	*	*	2	*	*	1200
Wool --,20°C, 30°C, 40°C		Machine washable wool. (Refer to the washing label attached to the clothing).	2.0	—	Yes	*	*	—	*	2	*	*	600
Shirts --,20°C, 30°C, 40°C, 60°C		Non-iron shirts or blouses made of cotton, linen, synthetic fibres or blended fabrics.	4.0	—	Yes	*	*	—	*	2	*	*	800
Dark Wash --,20°C, 30°C, 40°C, 60°C		Dark textiles made of cotton and dark easy-care textiles	4.0	*	Yes	*	*	*	*	2	*	*	1000
Quick 15' --,20°C, 30°C, 40°C		Cotton, mixed fabrics. Items worn for a short time or newly bought.	1.0	—	Yes	*	*	—	*	1	*	*	800
Mix --,20°C, 30°C, 40°C		Mixed loads of moderately soiled cotton and synthetic fabrics.	4.0	*	Yes	*	*	*	*	2	*	*	1200
Sportswear --,20°C, 30°C, 40°C		Sportswear and leisure wear made from microfibre fabrics.	4.0	*	Yes	*	*	*	*	2	*	*	1000
Duvet --,20°C, 30°C, 40°C		Machine-washable items stuffed with synthetic fibres, such as pillows, quilts and bedspreads; also suitable for items stuffed with down.	4.0	—	Yes	*	*	—	*	2	*	*	600
Silk/Delicate --,20°C, 30°C, 40°C		Soft delicate fabrics and machine washable silk. (Refer to the washing label attached to the clothing).	2.0	—	Yes	*	*	—	*	3	*	*	600
Drum Clean 95°C	—	Program to remove dirt and bacterial residue that can breed in the machine after it has been used for a period, especially when low temperature washes are used regularly.	—	—	Yes	—	*	—	—	1	—	—	600
Rinse +Spin	—	This program is defaulted to two rinses and spin.	8.0	—	—	*	*	—	*	2	*	—	1200
Spin	—	Select the length, and speed, of the spin manually.	8.0	—	—	—	—	—	—	0	*	—	1200

\* : Optional Functions      Yes : Detergent Required      : Cannot be selected    -- : Temperature of unheated water

(1) Wash performance test programs are: cotton eco 40°C, maximum speed.

PARAMETER	
Model	HWFV8012/HWFFV8012S/ HWFV8012T/HWFM8012/ HWFM8012S/HWFM8012T
Washing Capacity	8.0kg
Max.spin speed	1200rpm
Net Weight	60kg
Dimension(WXDXH)	595X595X850mm
Rated Voltage	220-240V~
Heating Power	1600W
Washing Power	200W

### Add Detergent, Close the Door and Set the Program

Load the clothes to be washed in the drum and close the door. Add the detergent into the relevant compartments for the type of program you are going to select, Add detergent as described in **Detergent and Additives** section of **User's Operation Manual**.

1. Turn on the power.
2. Spin program selection button to required program, start up.
3. Select washing temperature, spin speed and delay time by pressing "Temp.", "Spin" and "Delay End" buttons.
4. Press "Options" button to select additional functions.
5. After starting the program, display window displays program length (hours: minutes) and additional function options in sequence.

### Addition function selection

At standby state, press "Options" button to select additional function for current program. Select only one function for each press, and then corresponding icon flashes. After starting up, program cannot be changed.

#### Pre-wash

Select the function to conduct pre-wash so as to enhance washing effects and better remove stains. This function is suitable for heavy dirt clothes.

Before inflowing, laundry detergent/ washing powder can be added to pre-wash box, and washing powder must be added to main wash box.

#### Extra Rinse

After set the function of rinsing adding, the program runs the rinsing process once again before running the softening, and the total running time of the program increases accordingly.

### Door Lock Icon

After the program starts the Door Lock icon will light up and the door will be locked.

- After completing program, door lock unlocks automatically. During pause, if door opening condition can be met halfway, the door lock will unlock and its indicator light will go out.
- When door lock indicator light flashes, door shall not be opened forcibly so as to avoid personal injury.

### Delay End Function

Delay function allows to run the machine at the consumers' convenience, for example, at night when electricity is cheaper.

- Only under the standby mode, this button is valid for selecting the reservation time.
- After the reservation function is selected, the time will increase 1h when each time the reservation button is pressed. Before reservation, if the program time does not satisfy the integral multiple of 1h, it shall be completed by pressing the reservation key for the first time, and then the time increases 1h when each time the reservation button is pressed. If the reservation is selected, before the program runs, the current reservation can be canceled by turning the button to select other programs.

• The delay time must be longer than the wash program length as the delay time is the time program will finish. For example: if the selected program time is 02:28, the delay time selected must be between 03:00 and 24:00.

- When the reservation process is operated, the icon of 'reservation time' will be on. When the reservation process is finished, the icon of 'reservation time' will be off, while the icon of the 'remaining time' will be on.

### Mute Function

• Press "Spin" and "Delay End" button simultaneously for 2 seconds, the screen will show "bEEP OFF". The Mute state will be set. In this state, all the beep will be disabled, except for the error alarm.

- Repeat the same process, Mute state will be disabled, the screen will show "bEEP On".
- The Mute function will continue to take effect before you turn it down manually.

### Child Lock

To strengthen the safety of children, this machine is equipped with Child Lock function.

- When the programme starts, press "Temp.+Spin" button for 2 seconds. The machine will beep once. Scree will show "SAFE On". After 2 seconds, the screen will show the program left time. Repeat this operation, the machine will beep once. The screen will show "SAFE OFF", the Child Lock will be released.
- When the Child Lock is set, all function buttons except "Off" will be shielded. Once any function except "Off" is chosen, the machine will beep. The screen will show "SAFE On" for 2 seconds. After the program ends, Child lock function will release automatically. Any error alarm will release the Child Lock function. Turn off and on the machine manually will reset the machine.
- Child Lock function cannot be set when the machine is in standby state.

### To Start the Program

After you have selected your options and placed detergent with in the detergent dispenser, turn on the water tap and press the "Start / Pause" button. It also displays the remaining program time.

### To Cancel the Program or Reselect the Options

1. Rotate the program to "Off" for 3 seconds to turn off the machine.
2. Select the new program and options.
3. Press "Start / Pause" button to turn on the machine without adding any extra detergent.

### End of the Program

When programme finished its running, it will display "End". The machine will not turn off automatically.

1. Rotate the program to "Off" to turn off the machine;
2. Close the tap;
3. Open the door and take the washed clothes out;
4. Slightly open the door to remove moisture in the pump.

### Reload in Process

If you want to reload clothes in the process of washing, please press "Start/Pause" button.

- If the door can be opened in the process, remaining time and the Door Lock icon in display will flash. Then the Door Lock icon will go out, and the door can be opened.
- If the Door Lock icon doesn't flash, it indicates that current temperature is over 50 C or you have passed the time for reloading in the process, namely no clothes allowed to load into the machine.

# Hisense



## INSTALLATION GUIDE



**NOISE, EXCESSIVE VIBRATIONS AND WATER LEAKAGES CAN BE CAUSED BY INCORRECT INSTALLATION.**

**NEVER MOVE THE APPLIANCE BY LIFTING IT BY THE WORKTOP.**

- Read this “INSTALLATION GUIDE” before operating.
- Keep this “INSTALLATION GUIDE” for future reference.
- Read the general recommendations about disposing of packaging in the INSTRUCTION FOR USE.

## PARTS SUPPLIED

- Package with small items



Instruction for use, installation guide, warranty card  
(depends on model)

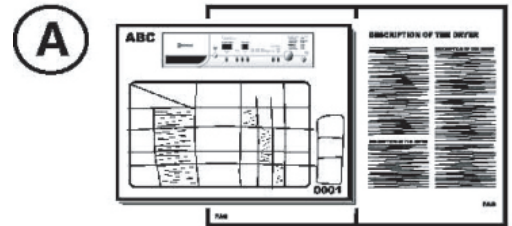

4 plastic caps

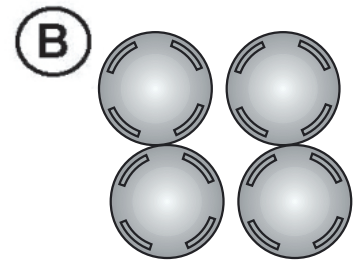

Wrench(depends on model)

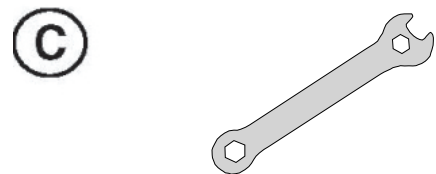

Inlet hose (inside the machine or already installed)

Cold inlet hose

Hot inlet hose (if available, depending on models)

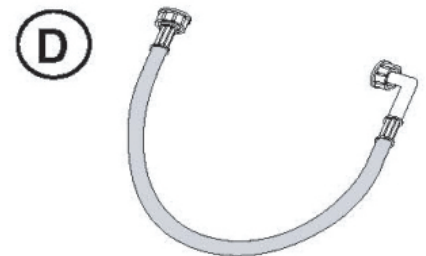

“U”-bend (inside the machine or already installed)

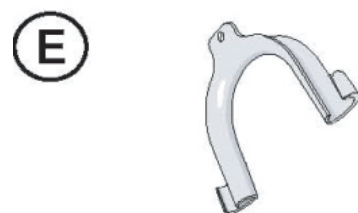

## BEFORE USING THE WASHER, PLEASE REMOVE TRANSPORT BOLTS!

**Important:** Transport bolts which are not removed can cause damage to the appliance.

- 1 Screw off all transportation bolts for approx. 30mm with wrench following the direction of arrow shown (not fully screw it off).

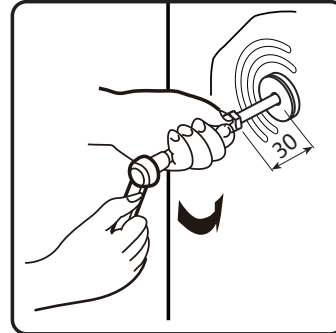
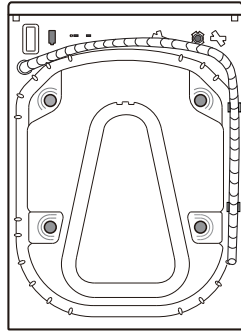

- 2 Push two transportation bolts on horizontal direction inward and loose transportation bolt.

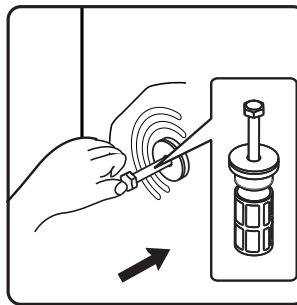

- 3 Pull out transportation bolt together with rubber part and plastic part.

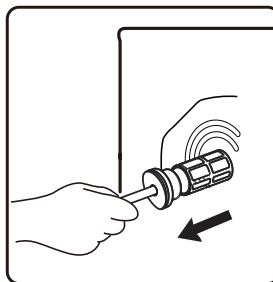

- 4 To ensure safety and reduce noise, you should install the transportation bolt cover supplied with the unit (see the annex accompanying the unit). Lean and place the transportation bolt into hole and press it following the shown direction until it clicks.

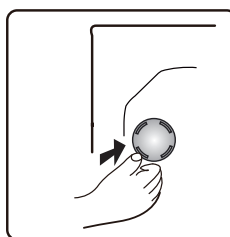

**Important:** Keep the transport bolts and the wrench for future transporting of the appliance and in this case refit the transport bolts in reverse order.

## ADJUSTMENT OF THE FEET

The appliance must be installed on a solid and level floor surface (if necessary use a spirit level). If the appliance is to be installed on a wooden floor, distribute the weight by placing it on a 60 x 60 cm sheet of plywood at least 3 cm in thickness and secure it to the floor. If the floor is uneven, adjust the 4 leveling feet as required; do not insert pieces of wood etc. under the feet.

- ⑤ Slacken the locknut clockwise (see arrow) using the wrench .



- ⑥ Lift the machine slightly and adjust the height of the foot by revolving it.

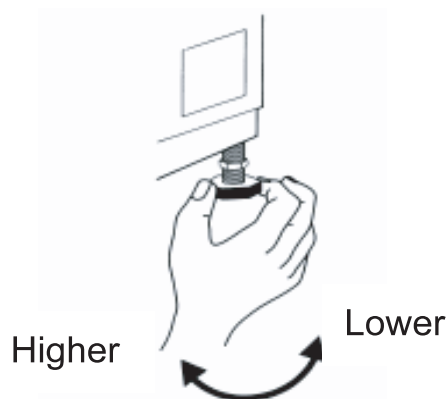

- ⑦ **Important:** tighten the locknut by turning it anti-clockwise towards the appliance casing.

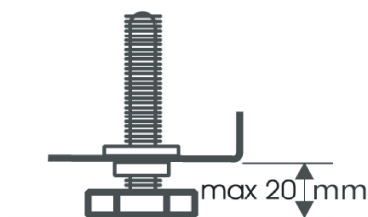
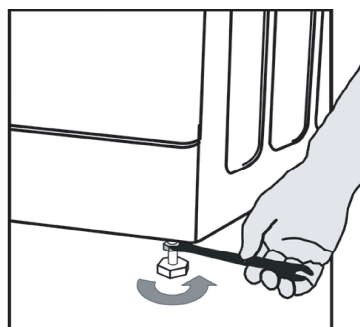

## CONNECT THE WATER SUPPLY INLET HOSE

8

If the water inlet hose is not already installed, it must be screwed to the appliance. The blue marked hose is only for cold water. Depending on the model, the hot water hose marked with red should also be connected, for models having Dual Inlets.

Hot (Depending on models)      Cold

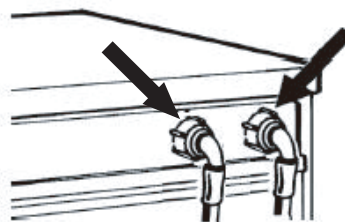

9

Screw by hand the inlet hose onto the tap, tightening the nut.

### Attention:

- no kinks in the hose!
- The appliance **must not** be connected to the mixing tap of an un-pressurized water heater.
- Check water-tightness of connections by turning the tap completely on.
- If the hose is too short, replace it with a suitable length of pressure resistant hose (1000 kPa min, EN 50084 approved type).
- Check the inlet hose regularly for brittleness and cracks and replace if necessary.
- The washing machine can be connected without a non-return valve.

## FILL INSTRUCTION

10

### For Models with Dual Inlets

If you wish to connect hot and cold water supply (Fig.1):

1. Fix the red marked inlet hose to the hot water tap and to the inlet valve with the red filter on the rear side of machine.
2. Fix the other inlet hose to the cold water tap and to the inlet valve with the blue filter on the rear side of the machine.

**Make sure:**

- a) The connections are tightly fixed
- b) Do not invert their position (for example: cold fill into hot inlet valve and vice versa).

If you wish to connect only the cold fill follow the below instructions (Fig. 2):

1. You need a Y-piece connector. This can be purchased from local hardware or plumbing supplier.
2. Fix the Y-piece connector to the cold fill tap.
3. Connect the two inlet valves present on the rear part of the machine to the Y-piece connector using the hoses provided.

### For Models with Single Inlet

Fix the inlet hose to the cold water tap and to the inlet valve on the rear side of the machine as Fig. 3

**Ensure that:**

**All connections are tightly fixed.**

**Do not allow children to operate, crawl on, be near or inside your washer.**

**Note that during the wash cycles, the surface temperature of the porthole door may increase.**

**Close supervision of children is necessary when the appliance is used near children.**

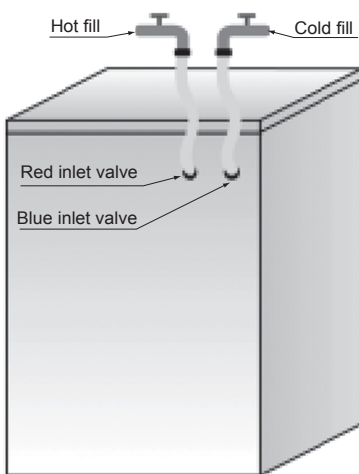

Fig.1

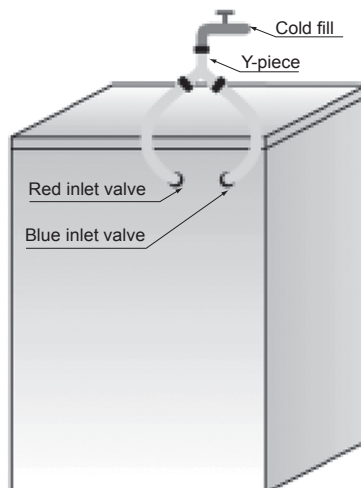

Fig.2

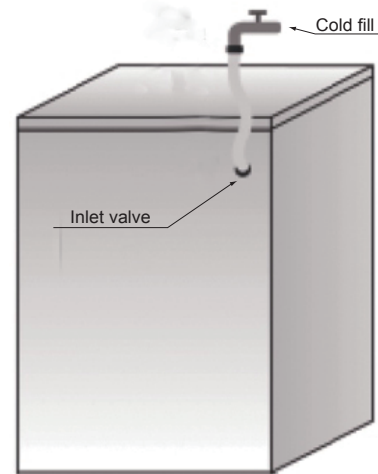

Fig.3



## CONNECT THE DRAIN HOSE

11

*In case the drain hose is installed as shown below:*

Unhook it only from the right clip (see arrow)

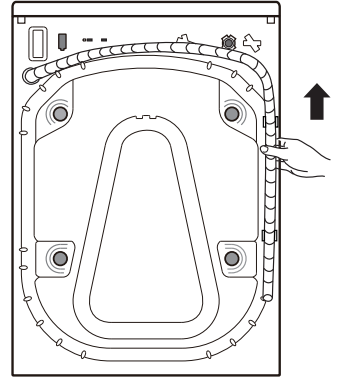

12

Connect the drain hose to the siphon or hook it over the edge of a sink by means of the "U" bend.

Fit the "U" bend E, if not already installed, at the end of the drain hose.

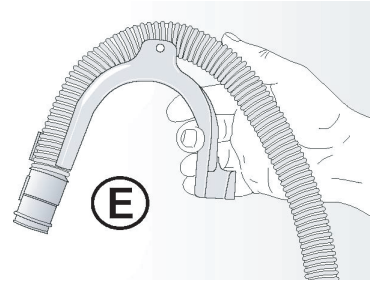

### Notes:

- Ensure that there are no kinks in the drain hose.
- Secure the hose so that it cannot fall down. After wash phase, machine will drain out hot water.
- Small hand basins are not suitable.
- To make an extension use a hose of the same type and secure the connections with clips.
- Max. Overall drain hose length: 2.50 m.

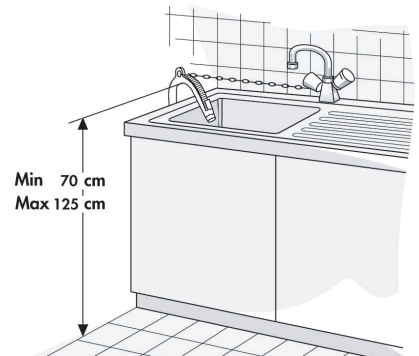

## ELECTRICAL CONNECTION



**Only use a socket with an earth connection.**

Do not use extension leads or multi sockets.

Electrical supply must be adequate for the machine's 10A Current Rating.

The electrical power cable must be replaced exclusively by a licensed electrician.

Electrical connections must be made in accordance with local regulations.



**Hisense**

**Hisense**

USER'S OPERATION MANUAL

Hisense

X08060287B

Before operating this unit, please read this manual thoroughly,  
and retain for future reference

# **INSTRUCTIONS FOR USE**

**BEFORE USING THE WASHING MACHINE**

**PRECAUTIONS AND GENERAL  
RECOMMENDATIONS**

**DESCRIPTION OF THE WASHING MACHINE**

**OPENING / CLOSING DOOR**

**CHILD SAFETY (IF AVAILABLE)**

**BEFORE THE FIRST WASH CYCLE**

**PREPARATION OF THE WASHING**

**DETERGENTS AND ADDITIVES**

**REMOVING THE FILTER**

**DRAINING RESIDUAL WATER**

**CARE AND MAINTENANCE**

**TROUBLESHOOTING GUIDE**

**AFTER-SALES SERVICE**

**TRANSPORT / HANDLING**

**ELECTRICAL CONNECTION**

## SAFETY INFORMATION

1. The manufacturer reserves the right for any modifications on the product which might be deemed necessary or useful without informing about it in this IFU.
2. Before operating your new washing machine, please read this instruction carefully, and keep it for future reference. If you have lost it accidentally, ask customer service for e-copy or hard copy.
3. Please make sure the socket is grounded securely, the water source connection is reliable.
4. This appliance is not to be used by persons (including children) with reduced physical, sensory or mental capabilities, or lack of experience and knowledge, unless they have been given supervision or instruction concerning use of the appliance by a person responsible for their safety.
5. This appliance can be used by children aged from 8 years and above and persons with reduced physical, sensory or mental capabilities or lack of experience and knowledge if they have been given supervision or instruction concerning use of the appliance in a safe way and understand the hazards involved. Children shall not play with the appliance. Cleaning and user maintenance shall not be made by children without supervision.
6. Children should be supervised to ensure that they do not play with the appliance.
7. If the supply cord is damaged, it must be replaced by the manufacturer, its service agent or similarly qualified persons in order to avoid a hazard.
8. The new hose-sets supplied with the appliance are to be used and that old hose-sets should not be reused.
9. For appliances with ventilation openings in the base, that a carpet must not obstruct the openings.
10. Children of less than 3 years should be kept away unless continuously supervised.
11. The maximum permissible inlet water pressure, 1 MPa, for appliances intended to be connected to the water mains. The minimum permissible inlet water pressure, 0.1 MPa, if this is necessary for the correct operation of the appliance.
12. Remove all objects from pockets such as lighters and matches.
13. The maximum washing capacity is 9 kg.
14. For private domestic use only.
15. This appliance is intended to be used in household and similar applications such as:
  - staff kitchen areas in shops, offices and other working environments;
  - farm houses;
  - by clients in hotels, motels and other residential type environments;
  - bed and breakfast type environments;
  - areas for communal use in blocks of flats or in launderettes.

## **BEFORE USING THE WASHING MACHINE**

### **1. Removing the packaging and inspection**

- After unpacking, ensure that the washing machine is undamaged. If in doubt, do not use the washing machine. Contact After-Sales Service or your local retailer.
- Check that the accessories and supplied parts are all present.
- Keep the packaging materials (plastic bags, polystyrene parts, etc.) out of reach of children, as they are potentially dangerous.

### **2. Remove the transport bolts**

- The washing machine is fitted with transport bolts to avoid any possible damage to the interior during transport. Before using the machine, it is imperative that the transport bolts are removed.
- After their removal, cover the openings with the 4 enclosed plastic caps.

### **3. Install the washing machine**

- Move the appliance without lifting it by the worktop.
- Install the appliance on a solid and level floor surface, preferably in a corner of the room.
- Ensure that all four feet are stable and resting on the floor and then check that the washing machine is perfectly level (use a spirit level).
- Ensure that the ventilation openings in the base of the washing machine (if available on your model) are not obstructed by a carpet or other material.

### **4. Water inlet**

- Connect the water supply inlet hose in accordance with the regulations of your local water company.
- Water inlet - Depending on models:
  - Single inlet - Cold water only
  - Dual inlet - Hot and cold water
- Water tap:            3/4"    threaded hose connector

## 5. Drain

- Connect the drain hose to the siphon or hook it over the edge of a sink by means of the “U” bend supplied.
- If the washing machine is connected to an integrated drainage system, ensure that the latter is equipped with a vent to avoid simultaneous loading and draining of water (siphoning effect).
- Fix the drain hose securely to prevent scalding during machine drainage.

## 6. Electrical connection

- Electrical connections must be carried out by a qualified technician in compliance with the manufacturer’s instructions and current standard safety regulations.
- Data regarding voltage, power consumption and protection requirements is given on the inside of the door.
- The appliance must be connected to the mains by means of a socket with an earth connection in accordance with current regulations. The washing machine must be earthed by law. The manufacturer declines all liability for damage to property or injury to persons or animals due to non-compliance with the directions given above.
- Do not use extension leads or multiple sockets. Make sure the capacity of the socket is powerful enough to drive the machine during heating.
- Before any maintenance on the washing machine disconnect it from the mains supply.
- After installation, access to the mains plug or to disconnection from the mains supply must be ensured at all times via a double-pole switch.
- Do not operate the washing machine if it has been damaged during transport. Inform After-Sales Service.
- Mains cable replacement is only to be carried out by After-Sales Service.
- The appliance must only be used in the household for the prescribed uses.

### Minimum housing dimensions:

Width: 600 mm

Height: 850 mm

Depth: refer to programme chart

## PRECAUTIONS AND GENERAL RECOMMENDATIONS

### 1. Packaging

- The packaging material is entirely recyclable, and marked with the recycling symbol . Adhere to current local regulations when disposing of packaging material.

### 2. Disposing of packaging and scrapping old washing machines

- The washing machine is built from reusable materials. It must be disposed of in compliance with current local waste disposal regulations.
- Before scrapping, remove all detergent residues, break the door hook, and cut off the power cable so that the washing machine is made unusable.

-  This appliance is marked according to the European directive on Waste Electrical and Electronic Equipment (WEEE). By ensuring that this product is disposed of correctly, you will help prevent potential negative consequences for the environment and human health, which could otherwise be caused by inappropriate waste handling of this product.

The symbol on the product, or on the documents accompanying the product, indicates that this appliance may not be treated as household waste. Instead it shall be handed over to the applicable collection point for the recycling of electrical and electronic equipment. Disposal must be carried out in accordance with local environmental regulations for waste disposal. For more detailed information about treatment, recovery and recycling of this product, please contact your local city office, your household waste disposal service or the shop where you purchased the product.

### 3. Location and surroundings

- The washing machine must only be installed in enclosed spaces. Installation in the bathroom or other places where air is humid is not recommended.
- Do not store flammable fluids near the appliance.

### 4. Safety

- Do not leave the appliance plugged in when not in use. Never plug or unplug the power from the mains supply, if your hands are wet.
- Turn off the tap.
- Before any cleaning and maintenance, switch off the machine or disconnect it from the mains.

- Clean the outside of the washing machine with a damp cloth. Do not use abrasive detergents.
- Never open the door forcibly or use it as a step.

## DESCRIPTION OF THE WASHING MACHINE

- 1 Worktop
- 2 Control panel
- 3 Detergent dispenser
- 4 Door
- 5 Child safety device (if provided, inside the door)
- 6 Plinth covering pump access
- 7 Adjustable feet

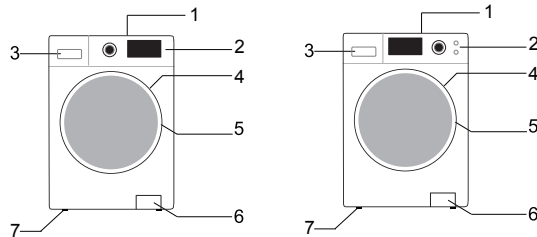

Control panel layout and appearance will depend on the model.

## OPENING/CLOSING DOOR

Only when the door opening light in green on control panel is lit, can the door be opened. Never open the door forcibly while the machine is running, otherwise you can damage the door lock. If you must open the door while the machine is running, first, turn off the power, or pause the cycle, then wait for at least 2 minutes for the door lock to be released.

To open the door, hold the door handle, press the inside handle and pull the door. Close the door by pressing it without excessive force until it clicks shut.

## CHILD SAFETY (IF AVAILABLE)

To protect the appliance against improper use, turn the plastic screw on the interior of the door. To do this, use a coin or similar objects.

- Slot vertical: the door will not lock.
- Slot horizontal - normal position: the door can be locked again



## BEFORE THE FIRST WASH CYCLE

To remove any residual water used during testing by the manufacturer, we recommend that you carry out a short wash cycle without laundry.

- 1 Open the tap.
- 2 Close the door.
- 3 Pour a little detergent (about 30 ml) into the main wash chamber (U) of the detergent dispenser .
4. Select and start a short programme (see separate quick reference guide).

## PREPARATION OF THE WASHING

### 1. Sort the laundry according to...

#### • Type of fabric / care label symbol

Cottons, mixed fibres, easy care/synthetics, wool, handwash items.

The wool wash cycle of this machine has been tested and approved by The Woolmark Company for the washing of Woolmark garments labelled as "machine wash" provided that the garments are washed according to the instructions on the garment label and those issued by the manufacturer of this washing machine.

#### • Colour

Separate coloured and white items. Wash new coloured articles separately.

#### • Loading

Wash items of different sizes in the same load to improve washing efficiency and distribution in the drum.

#### • Delicates

Wash small items (e.g. nylon stockings, belts etc.) and items with hooks (e.g. bras) in a cloth bag or pillow case with zip. Always remove curtain rings or wash curtains with the rings inside a cotton bag.

### 2. Empty all pockets

Coins, safety pins etc. can damage your laundry as well as the appliance drum and tub.

### 3. Fasteners

Close zips and fasten buttons or hooks; loose belts or ribbons should be tied together.

#### • Stain removal

Blood, milk, eggs etc. are generally removed by the automatic enzyme phase of the programme.



- To remove red wine, coffee, tea, grass and fruit stains etc. add a stain remover to the main wash chamber  of the detergent dispenser.
- Pre-treat heavily-soiled areas with stain remover if necessary.

### Dyeing

- Only use dyes that are suitable for washing machines.
- Follow the Manufacturer's instructions.
- Plastic and rubber parts of the washing machine can be stained by dyes.

### Loading the laundry

- 1 Open the door.
- 2 Load the articles one at a time loosely into the drum, without overfilling. Observe the load sizes given in the quick reference guide.  
**Note:** Overloading the machine will result in unsatisfactory washing results and creased laundry.
- 3 Close the door.

## DETERGENTS AND ADDITIVES

Always use high efficiency, low foam detergent for a front load machine.

The choice of detergent depends on:

- type of fabric (cottons, easy care/synthetics, delicate items, wool).  
Note: Use only specific detergents for washing wool
- colour
- the wash temperature
- degree and type of soiling

### Remarks:

Any whitish residues on dark fabrics are caused by insoluble compounds used in modern phosphate-free powder detergents. If this occurs, shake or brush out the fabric or use liquid detergents. Use only detergents and additives specifically produced for domestic washing machines. When using descaling agents, dyes or bleaches for the pre-wash, make sure that they are suitable for use in domestic washing machines. Descalers could contain products which could damage your washing machine. Do not use any solvents (e.g. turpentine, benzene). Do not machine wash fabrics that have been treated with solvents or flammable liquids.

### Dosage

Follow the dosage recommendations on the detergent pack. They depend

on:

- degree and type of soiling
- size of wash
- follow the detergent manufacturer's instructions for a full load;
- half load: 3/4 the amount used for a full load;
- minimum load (about 1 kg): 1/2 the amount used for a full load;
- water hardness in your area (ask for information from your water company).  
Soft water requires less detergent than hard water.

### Notes:

Too much detergent can result in excess foam formation, which reduces washing efficiency. If the washing machine detects too much foam, it may prevent spinning.

Insufficient detergent may result in grey laundry in time and also calcifies the heating system, drum and hoses.

### Where to put detergent and additives

The detergent drawer has three chambers (fig. "A" )

### Prewash chamber

- Detergent for the prewash / soak

### Mainwash chamber

- Detergent for the main wash
- Stain remover
- Water softener (water hardness class 4)

### Softener chamber

- Fabric softener
- Liquid starch

Pour additives only up to the "MAX" mark.

### How to position the separator in the main wash chamber for powder or liquid detergent

For use with powder detergent: Place the separator in the higher position. Lift the separator until its top can be reclined. Place its hooks on the upper end of the back guide rails and slightly push the separator down to fix it

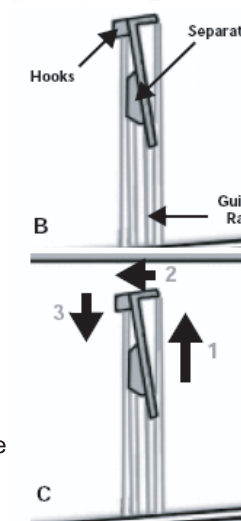
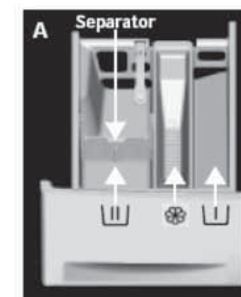

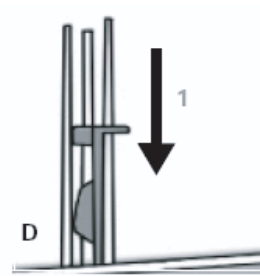

(fig. "B" and "C") .

A gap should remain between the separator and the bottom of the main wash chamber. If the separator has been correctly installed (fig. "B" and "C") . ;  
For use with liquid detergent: place the separator in the lower position. Secure the separator in the chamber using the front guide rails. Position the separator so that it touches the bottom of the main wash chamber  (fig. "D")



#### Notes:

- Keep detergents and additives in a safe, dry place out of the reach of children.
- Liquid detergents can be used for programmes with prewash. However, in this case a powder detergent must be used for the main wash.
- Do not use liquid detergents when activating the "Start Delay" function (if available on your washing machine).
- To prevent dispensing problems when using highly concentrated powder and liquid detergents, use the special detergent ball or bag supplied with the detergent and place it directly inside the drum.
- When using descaling agents, bleaches or dyes, make sure that they are suitable for washing machines. Descalers could contain compounds that can damage parts of your washing machine.
- Do not use any solvents in the washing machine (e.g. turpentine, benzene).
- If you use starch powder, proceed as follows:
  1. Wash your laundry using the desired wash programme.
  2. Prepare the starch solution according to the starch manufacturer's instructions.
  3. Select the "Rinse and Spin" programme, reduce the speed to 800 rpm and start the programme.
  4. Pull out the detergent drawer until you can see about 3 cm of the main wash chamber .
  5. Pour the starch solution into the main wash chamber  while the water is running into the detergent drawer.
  6. If there are starch residues in the detergent drawer when the programme has finished, clean the main wash chamber.

## REMOVING THE FILTER

We recommend that you check and clean the filter regularly, at least two or three times a year.

#### Especially:

- If the appliance is not draining properly or if it fails to perform spin cycles.
- If the pump is blocked by a foreign body (e.g. buttons, coins or safety pins).

**IMPORTANT: Ensure that the water has cooled before draining the appliance.**

- 1 Stop the appliance and unplug it.
- 2 Depending on the model, Insert removal tool like slotted screwdriver into the small opening of bottom baffle, press the bottom baffle downward with much strength and open it. Or, push down on the tabs provided on both the sides and remove it.
- 3 Place a container beneath it.
- 4 Open the filter but do not remove it completely. Slowly turn the filter counterclockwise until the water begins to drain out.
- 5 Wait until all the water has drained.
- 6 Now unscrew the filter completely and remove it.
- 7 Clean the filter and the filter chamber.
- 8 Check that the pump rotor moves freely.
- 9 Re-insert the filter and screw it in clockwise as far as it will go.
- 10 Pour about 1 litre of water into the detergent drawer to reactivate the "Eco system". Check that the filter is inserted properly and securely.
- 11 Reinstall the plinth.
- 12 Plug in the appliance once again.
- 13 Select a programme and start it.



## DRAINING RESIDUAL WATER

**Before emptying the residual water, switch the appliance off and unplug it from the mains socket. Remove the plinth. Place a container beneath it.**

1. Open the filter but do not remove it completely. Slowly turn the filter counterclockwise until the water begins to drain out.
2. Wait until all the water has drained.
3. Now unscrew the filter completely and remove it.
4. Tilt the appliance forward carefully to allow the water to flow out.
5. Refit the filter and screw it in clockwise as far as it will go.
6. Refit the plinth.

**Before using the washing machine again:**

1. Pour approx. 1 litre of water into the detergent drawer to reactivate the "Eco system".
2. Plug in the appliance once again.

## CARE AND MAINTENANCE

**Appliance exterior and control panel**

- Can be washed down with a soft, damp cloth.
- A little neutral detergent (non abrasive) can also be used.
- Dry with a soft cloth.

**Door seal**

- Clean with a damp cloth when necessary.
- Check the condition of the door seal periodically.

**Filter**

- Check and clean the filter regularly, at least two or three times a year (see "Removing the filter").

**Do not use flammable fluids for cleaning the appliance.**

**Detergent dispenser**

1. Press the release lever in the main wash compartment downward and remove the drawer (fig. "A").
2. Remove the cover grid from the fabric softener compartment. Remove the separator from the main wash compartment by pulling it upward (fig. "B").
3. Wash all the parts under running water.
4. Refit the separator and the grid in the detergent drawer and fit the drawer back inside its housing.



**Water supply hose**

Check the supply hose regularly for brittleness and cracks and replace it if necessary using a new hose of the same type (available from After-Sales Service or specialist dealer).

**Mesh filter for water connection**

Check and clean regularly.

For washing machines with an inlet hose as shown on pictures "A",

1. Close the tap and loosen the inlet hose on the tap.
2. Clean the internal mesh filter and screw the water inlet hose back onto the tap.
3. Now unscrew the inlet hose on the rear of the washing machine.
4. Pull off the mesh filter from the washing machine connection with universal pliers and clean it.
5. Refit the mesh filter and screw the inlet hose on again.
6. Turn on the tap and ensure that the connections are completely water-tight.



## TROUBLESHOOTING GUIDE

Depending on the model, your washing machine is equipped with various automatic safety functions. This enables faults to be detected in good time and the safety system can then react appropriately. These faults are frequently so minor that they can be resolved within a few minutes.

### **The washing machine will not start, no screen are off.**

Check whether:

- the mains plug is inserted into the socket and Choose the desired programme to start the machine.
- the wall socket is functioning correctly (use a table lamp or similar appliance to test it).

### **The washing machine will not start, and the screen flashes.**

Check whether:

- the door is properly closed (child safety);
- the “**Start/Pause**” button has been pressed;
- Check if the water tap is closed. Open the water tap and press the “**Start/Pause**” button.

### **The appliance stops during the programme** (varies depending on model)

Check whether:

- the “Rinse Hold” indicator lamp lights up; terminate this option by pressing the “**Start/Pause**” button or by choosing and starting the “**Drain**” programme;
- the screen is flashing. Press the “**Start/Pause**” button.
- the door has been opened and the screen is flashing. Close the door and press the “Start/Pause” button again.
- Check if there is too much foam inside, machine enters kill-foam routine. The machine will run again automatically after a period.
- the washing machine’s safety system has been activated (see “Fault description table”).

### **Residue from detergent and additives left in the detergent drawer at end of wash.**

Check whether:

- the cover grid of the softener chamber and the separator of the main wash chamber are correctly installed in the detergent dispenser and all parts are

clean (see “Care And Maintenance”);

- sufficient water is entering. The mesh filters of the water supply could be blocked (see “Care and Maintenance”);
- the position of the separator in the main wash chamber is adapted to the use of powder or liquid detergent (see “Detergent and Additives”).

### **Machine vibrates during spin cycle.**

Check whether:

- the washing machine is level and standing firmly on all four feet;
- the transport bolts have been removed. Before using the machine, it is imperative that the transport bolts are removed.

### **Final spin results are poor.**

The washing machine has an imbalance detection and correction system. If individual heavy items are loaded (e.g. bathrobes), this system may reduce the spin speed automatically or even interrupt the spin completely if it detects too great an imbalance even after several spin starts, in order to protect the washing machine.

- If the laundry is still too wet at the end of the cycle, remove some articles of laundry and repeat the spin cycle.
- Excessive foam formation may prevent spinning. Use the correct amount of detergent.
- Check that the spin speed selector has not been set to “0”.

### **If your washing machine has a time display: the programme time initially displayed is lengthened / shortened by a period of time:**

This is a normal capacity of the washing machine to adapt to factors that can have an effect on the wash programme time, e.g.:

- excess foam formation;
- load imbalance due to heavy items of laundry;
- prolonged heating time due to reduced inlet water temperature;

Because of influences like these, the time remaining in the programme run is recalculated, and updated if necessary. In addition, during the filling phase, the washing machine determines the load and if necessary adjusts the initial programme time displayed accordingly. During such update periods, an animation appears on the time display.

## Hot / Cold fill fault - For Models with Dual Inlets

### If you wish to connect hot and cold water supply (Fig.1):

1. Fix the red marked inlet hose to the hot water tap and to the inlet valve with the red filter on the rear side of machine.
2. Fix the other inlet hose to the cold water tap and to the inlet valve with the blue filter on the rear side of the machine.

### Make sure:

- a) The connections are tightly fixed
- b) Do not invert their position (for example: cold fill into hot inlet valve and vice versa).

### If you wish to connect only the cold fill follow the below instructions (Fig. 2):

1. You will need a Y-piece connector. This can be purchased from local hardware or plumbing supplier.
2. Fix the Y-piece connector to the cold fill tap.
3. Connect the two inlet valves present on the rear part of the machine to the Y-piece connector using the hoses provided.

### Ensure that:

All connections are tightly fixed.

Do not allow children to operate, crawl on, be near or inside your washer.

Note that during the wash cycles, the surface temperature of the porthole door may increase.

Close supervision of children is necessary when the appliance is used near children.

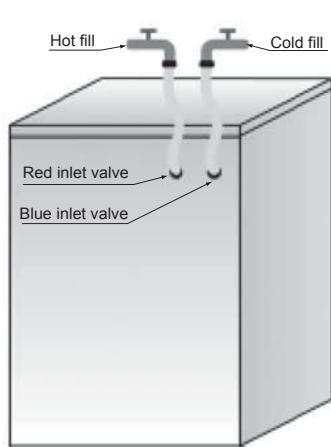

Fig.1

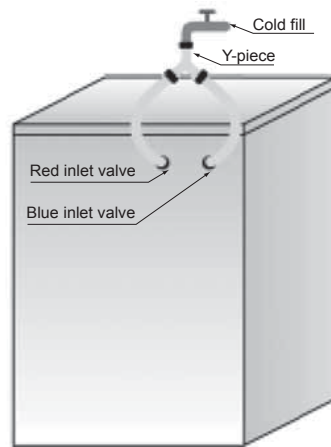

Fig.2

Fault Code List	
Displayed on Display Window	Fault Description
"F01"	Water inflow fault
"F03"	Drainage fault
"F04", "F05", "F06", "F07", "F23" and "F02/F24"	Electronic module fault, overflow or too much foam.
"F13"	Door lock fault
"F14"	Door unlock fault
"Unb"	Unbalance alarm

### a. "F01" displayed on screen

The machine is not fed with water or insufficient water. Check:

- Faucet is fully open and has enough water pressure.
- Water inlet pipe is knotted or not.
- Filtering net of water inlet pipe is blocked or not (refer to maintenance and repair).
- Water pipe is frozen or not.

Press "Start/Pause" key after fault is removed.

If fault occurs again, please contact with after-sale service (refer to after-sale service.).

### b. "F03" displayed on screen

The washer is not emptied. The washer stops the program being executed. Shut down the machine and disconnect power supply. Check:

- Drain pipe is knotted or not.
- Filter in drain pump is blocked or not (refer to the cleaning of filter in drain pump)

**IMPORTANT:** Ensure that the water has cooled before draining the appliance.

- the drain hose is frozen up.

Plug in the appliance again.

Select and start the "Drain" programme or restart the desired programme.

If the fault occurs again, please contact After-Sales Service (see "After-Sales Service").

## C. Fault code

The washer stops when the program is running. The display window shows fault code "F02/F24", fault codes from "F04" to "F07", "F13", "F14", "F23" or "Unb".

### If fault code "F02/F24" is shown

Water level reaches overflow level.

Remove it by pressing "Start/Pause" key and feed water.

Select and start required program. If fault occurs again, disconnect power supply and contact with after-sale service.

### If fault code "F04" to "F07", "F23" shown

Electronic module fails.

Turn the nub to Off for 3 seconds to turn off the machine.

After fault is removed, press "Start/Pause" key. If fault occurs again, disconnect power supply and contact with after-sale service.

### If fault code "F13" is shown

Door lock is abnormal. Start program for 20 sec and unlock the washer door (PTC) to check whether the door is closed.

Open and close it again.

After fault is removed, press "Start/Pause" key. If fault occurs again, disconnect power supply and contact with after-sale service.

### If fault code "F14" is shown

Door open fault..

Action: Press "Start/Pause" button. The washing machine will try to open the door. The alarm will be removed until the door is unlocked. Or, turn the nub to Off for 3 seconds to turn off the machine. Choose the desired programme to start the machine. The alarm will be removed.

### If fault code "Unb" is shown

Unbalance alarm.

Turn the nub to Off for 3 seconds to turn off the machine. Open the door and re-tidy clothes and then rotate program knob to single dehydration mode. Spin clothes to dry again.

If fault occurs again, disconnect power supply and contact with after-sale service.

## AFTER-SALES SERVICE

### Before contacting After-Sales Service:

- 1 Try to remedy the problem yourself (see "Troubleshooting Guide").
- 2 Restart the programme to check whether the problem has solved itself.
- 3 If the washing machine continues to function incorrectly, call After-Sales Service.

## TRANSPORT/HANDLING

### Never lift the appliance by the worktop when transporting.

- 1 Pull out the mains plug.
- 2 Turn off the tap.
- 3 Disconnect the inlet and drain hoses.
- 4 Eliminate all water from the hoses and from the appliance (see "Removing the Filter", "Draining Residual Water").
- 5 Fit the transport bolts (obligatory).
- 6 The machine is over 55 kg in weight, two persons are needed to move it.

## ELECTRICAL CONNECTION

### Only use a socket with an earth connection.

- Do not use extension leads or multi sockets.
- Electric supply must be adequate for the machine's 10 A Current Rating.
- Electrical connections must be made in accordance with local regulations.
- The electrical power cable must be replaced exclusively by a licensed electrician.