

FOTILE

USER'S HANDBOOK

Please read this instruction manual carefully before using

BUILT-IN GAS COOKTOP

GLG86322 GLS90303 GLG60409

Every effort has been made to ensure that the information given in this manual is correct at the time of printing. However, due to the continuous product improvement, FOTILE reserves the right to make changes to the products and technical data without prior notice.

NINGBO FOTILE KITCHENWARE CO., LTD.
NO. 218 BINHAI 2 ROAD, HANGZHOU BAY DISTRICT, CIXI, NINGBO, P. R. China
Tel: 0086-574-23456666
Website:WWW.FOTILE.COM
E-mail:overseas@fotile.com

110200250296E/20201031

CONTENT

SPECIFICATION	1
WARNING AND SAFETY INSTRUCTIONS	2
USAGE PRECAUTIONS	5
INSTALLATION PRECAUTIONS	6
PACKAGE DISPOSAL INSTRUCTIONS - ENVIRONMENT POLICY	8
INSTRUCTIONS FOR THE INSTALLER	8
PACKING LIST	8
INSTRUCTIONS FOR THE USER	10
CLEANING AND MAINTENANCE	12
TROUBLESHOOTING	14
WIRING DIAGRAM	16
CONVERTING THE COOKTOP FROM NG TO ULPG	17

SPECIFICATION

Notice: Please read this specification carefully before using, which is important for you.

Gas Type	Burner	Heat Input (MJ/h)	Nozzle diameter (mm)	Model		
				GLG86322	GLS90303	GLG60409
ULPG 2.75kPa	Large	16.5	0.92&0.45*2	2	2	1
	Small	7.2	0.72	1	1	0
	Semi-rapid	5.6	0.65	0	0	2
	Auxiliary	2.6	0.45	0	0	1
	Total Heat Input(MJ/h)			40.2	40.2	30.3
NG 1.0kPa	Large	16.5	1.74&0.6*2	2	2	1
	Small	7.2	1.25	1	1	0
	Semi-rapid	6.4	1.15	0	0	2
	Auxiliary	2.8	0.78	0	0	1
	Total Heat Input(MJ/h)			40.2	40.2	32.1

THESE INSTRUCTIONS ARE VALID ONLY FOR END USER COUNTRIES WHOSE IDENTIFICATION SYMBOLS(THESE COUNTRIES' ABBREVIATION CODE)APPEAR ON THE CARTON LABEL.THE INSTRUCTIONS MUST BE TRANSLATED INTO OFFICIAL LANGUAGE OF END USER COUNTRIES.



INSTRUCTIONS FOR THE USER: these provide recommendations for use, a description of the controls and the correct procedures for cleaning and maintaining the appliance.



INSTRUCTIONS FOR THE INSTALLER: these are intended for the qualified engineer who install, commission and test the appliance.

WARNING AND SAFETY INSTRUCTIONS

Special version:

Please properly use the appliance, strictly complying with the user manual. FOTILE company will not bear responsibility for property loss and personal injury due to improper use.

Warning: It may cause people danger, serious injury or fire, if you ignore the following contents and improperly operate.

If the supply cord is damaged, it must be replaced by the manufacturer or its service agent or a similarly qualified person in order to avoid a hazard.





This appliance is not intended for use by persons (including children) with reduced physical, sensory or mental capabilities, or lack of experience and knowledge, unless they have been given supervision or instruction concerning use of the appliance by a person responsible for their safety.

Children should be supervised to ensure that they do not play with the appliance.



Warning: Servicing shall be carried out only by authorized personnel, and that the appliance shall not be modified!

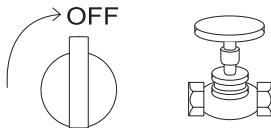





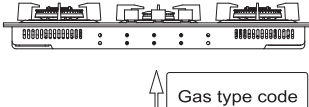

Strictly Execute

	The gas cooktop can be used only in domestic kitchen. Please do not install it in the bath room, bed room, basement or places that are flammable, explosive and corrosive.
	Such works as gas cooktop installation, refitting, removal, dismantle, repair should be done installed by authorized installers certificated companies and operated by professional people.
	Some gas suppliers provide " Gas Usage Safety Manual " You must ask gas operating agency for "Gas Usage Safety Manual " , and comply with it. The appliance must be installed in accordance with AS5601, local gas authority regulations, the gas cooktop will go wrong due to gas pressure abnormality.
	To prevent asphyxiation, after installation and before usage, please check you cannot smell gas. Keep the room ventilated when daily use.
	If there is gas leak, please turn off the switch knob and appliance isolating gas valve soon, open the window, contact FOTILE service center to repair it. At this time, don't touch the power switch or ignite, and don't use mobile phone, fixed-line telephone etc, to prevent explosion.

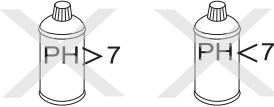
	Please don't let the gas cooktop work at strong wind disturbing environment, because it will influence the normal burning, even failed to work.
	If there happens burning due to over high oil temperature, please cover the source of fire with large size metal items, like iron pot cover (please don't use water), and close the general gas valve.
	Please periodically replace grease resistant gas rubber hose. Suggest the hose should not be used for more than one and half year. Don't place the hose on the cooktop or near the cooktop panel.
	Please don't go out or go to bed when gas cooktop is working. Please turn off the knobs and general gas valve after usage and repeatedly check whether they are turned off before you sleep or go out.
	Please keep the product plastic package away from the infants, to avoid suffocation, etc.

⚠ Forbidden

	Do not modify this appliance.
	Please confirm the gas type is the same with nameplate indicate before using. It is forbidden to change into other gas type, especially the man-made gas which produces CO.
	This gas cooktop is for heating cook utensil, don't use it for drying towels, clothes, etc. DO NOT USE THIS APPLIANCE AS A SPACE HEATER.
	Please don't turn on the gas cooktop for heating when there is no pan or there is no food in the pan. It may damage the range hood which is above the stove, even will burn the grease inside of the range hood and cause fire accident.

	Please don't touch the cooktop that is off work for a short while, to avoid scalding.
	Do not use or store flammable materials in the appliance storage drawer or near this appliance.
	Please don't place any acidic or alkaline substance on the cooktop (vinegar, lemon juice, etc).
	Do not place anything, e.g. flame tamer, asbestos mat, between pan and pan support as serious damage to the appliance may result.
	Do not remove the pan support and enclose the burner with a wok stand as this will concentrate and deflect heat onto the hotplate.
	Do not use large pots or heavy weights which can bend the pan support or deflect flame onto the hotplate.
	Locate pan centrally over the burner so that it is stable and does not overhang the appliance.
	Use only a wok support supplied or recommended by the manufacturer of the appliance.
	Do not spray aerosols in the vicinity of this appliance while it is in operation.

 The glass used in FOTILE products is tempered glass, and the tempering mechanism of glass decides that there is extremely small probability for tempered glass self explosion. Once it happens self explosion do not due to improper use, we promise to replace the tempered glass for free.

USAGE PRECAUTIONS



This manual is an integral part of the appliance. Take good care of it and keep it on hand throughout the hob's lifecycle.

We urge you to read this manual and all the information it contains carefully before using the appliance.

The manufacturer declines all liability for uses other than those stated above.



This appliance is not connected to a combustion products exhaust system device. It shall be installed and connected in accordance with current installation regulations. Particular attention shall be paid to the relevant requirements regarding ventilation.



Before installation, please ensure that the local distribution conditions (Type of the gas and gas pressure) and the adjustment of the appliance are compatible.

The appliance are designed for using gases of Natural Gas and Universal LPG.



Never use this appliance for heating rooms.



Never use packaging residues unattended in the house. Separate the various waste packaging materials by type and consign them to the nearest separate disposal centre.



This appliance is marked according to the European directive 2002/96/ec on Waste Electrical and Electronic Equipment (WEEE). This guideline is the frame of European-wide validity of return and recycling on waste electrical and electronic equipment.



Never obstruct the openings and slits provided for ventilation and heat dispersal.



The nameplate with the technical data, serial number and mark are in a visible position underneath the casing. The nameplate must never be removed where the data plate cannot be easily seen at installation. The 'duplicate data plate must be fitted in a adjacent position where it can be seen by the operator.



Poisoning Hazard.

Never use this appliance as a space heater to heat or warm the room.

Doing so may result in carbon monoxide poisoning and overheating of the appliance.

Failure to follow this advice may result in poisoning or death.



Hot Surface Hazard

This appliance becomes hot during use.

Do not touch the cooktop components, burners, pan supports or the ceramic glass when hot.



Fire Hazard

Never leave the appliance unattended when in use. Boilover causes smoking and greasy spillovers that may ignite.

Failure to follow this advice may result in serious injury.



Explosion Hazard

Do not use cooktop where flammable materials such as gasoline near this appliance.

Do not spray aerosols in the vicinity of this appliance while it is in operation.

Failure to follow this advice may result in death or serious injury.



Electrical Shock Hazard

If the glass should break or crack, turn off the gas supply and switch the appliance off immediately at the mains power supply (wall switch) and contact a qualified technician.

Failure to follow this advice may result in death or electrical shock.



The appliance is intended for use by adults. Keep children at a safe distance and never allow them to play with it.



Always check that the control knobs are turned off after each use.



The manufacturer declines all responsibility for injury or damage caused by failure to comply with the above regulations or deriving from tampering with even just one part of the appliance and the use of non-original spare parts.

INSTALLATION PRECAUTIONS



Electrical shock hazard

Failure to do so could result in electrical shock or death.



Cut hazard

Take care-panel edges are sharp.

Failure to use caution could result in injury or cuts .

■ Important safety precautions

- Particular attention shall be given to the relevant requirements regarding ventilation.
- Please make this information available to the person installing the appliance as it could reduce your installation costs.
- This appliance is to be installed and connected and gas supply only by an authorised person.
- Installation must comply with your local building and local gas authority codes and electricity regulations.
- Failure to install the appliance correctly could invalidate any warranty or liability claims.
- This gas appliance is suitable for connection to natural gas or LP gas only .If in doubt, refer to the local gas network operator or gas supplier to confirm gas type at installation site.

Before you install the appliance, please make sure that

- The local distribution conditions (nature of gas and pressure) and the adjustment of the appliance are compatible. For adjustment conditions for this appliance check data plate for relevant gas information.
- This appliance uses 220-240V 50Hz power supply.
- The supply connection point (gas shut-valve) is accessible after installation. The regulator supplied with Natural gas appliances must be fitted to the appliance inlet.
- The benchtop is made of a heat resistant material. the installation complies with all the requirements of Australian and New Zealand Gas Installation Standards (AS5601), including that the product has to be installed so that the surface temperature of any nearby combustible surface will not exceed 65°C above ambient. See page 9 'Attachment to support structure, traditional built-in model'.

When you install the appliance

- We do not recommend the use of a down-draught extractor fan with the appliance, as it may distort the flame pattern, causing uneven heating and reduced cooking performance.
- Where this appliance is installed in marine craft or in caravans, it shall not be used as a space heater. Only models fitted with the flame failure device can be fitted in marine craft. No combustible material or products should be placed on this appliance at any time.
- Do not spray aerosols in the vicinity of this appliance while it is in operation.
- If, after following the instructions given, the appliance cannot be adjusted to perform correctly, please refer to the Service & Warranty book for warranty details and your nearest Authorised Service Centre,
- Customer Care, or contact our local distributors.

PACKAGE DISPOSAL INSTRUCTIONS - ENVIRONMENT POLICY

Our products are only packaged using non-pollutant, environment-friendly, recyclable materials. We urge you to cooperate by disposing of the packaging properly. Contact your local dealer or the competent local organizations for the addresses of collection, recycling and disposal facilities. Never leave all or part of the packaging lying around. Packaging parts, and especially plastic bags, may represent a suffocation hazard for children. Your old appliance must also be disposed of properly. Important: deliver the appliance to your local organization authorized to collect scrapped appliances. Proper disposal allows the intelligent recovery of valuable materials.



Never leave packaging residues unattended in the house. Separate waste packaging materials by type and consign them to the nearest separate disposal centre.



The inside of the appliance should be cleaned to remove all manufacturing residues. For further information, see point "CLEANING AND MAINTENANCE".

INSTRUCTIONS FOR THE INSTALLER



The following operation requires building and/or carpentry work, so it must be carried out by a qualified person. Installation can be carried out with various materials such as masonry, metal, solid wood or plastic laminated wood, as long as they are heat-resistant (T90°C)

PACKING LIST

Please pay attention to the amount of accessories, and make sure there is no scarcity or shatters

- (1) Please contact with the dealer when our company or the dealer is responsible for the above carelessness.
- (2) Please contact the nearest service center engaged by special arrangement if the user should undertake the responsibility.

	Complete Appliance	1		Regulator	1
	User Manual & Warranty Card & Needle				

■ **Attachment to support structure, traditional built-in model**

If it's GLS90303 or GLG86322, create an opening with the dimensions 816mm(L)×460mm(W) (if it's GLG60409, create an opening with the dimensions 561mm(L)×481mm(W)) shown in the figure 1. On the work surface, observing a minimum distance of 50mm from the rear edge. This appliance can be installed next to walls that are higher than the work surface, as long as the distance "X" is kept between the appliance and the wall, as shown in the figure 2, to avoid damage from overheating. Make sure there is a minimum of 600mm between the work surface and the range hood that may be installed directly above them (figure 2).

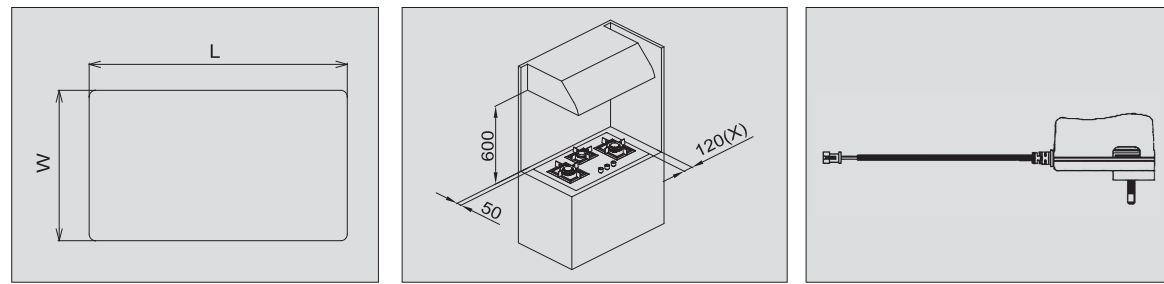

figure 1

figure 2

figure 3

■ **Electrical connection**

Make sure that using alternating current (AC) as power supply connect the product with the power supply and operate rightly.

The cooker is powered by adaptor.

- Please use the adapter in the package or purchased from the FOTILE service center.
- Connection of AC.



Make sure that the voltage and capacity of the power supply cable conform to the data shown on the plate located under the protective cover.

The adaptor and the wall socket must be of the same type and conform to the current electrical system regulations. Make sure that the power line is adequately earthed.

On the power line, install an all-pole disconnect switch with minimum contact gap of 3mm located at an easily accessible position near the appliance.

Do not use reducers or shunts.

■ **Gas connection**

Important: figure 4

Insure the Elbow and NG regulator are connected by PTFE.

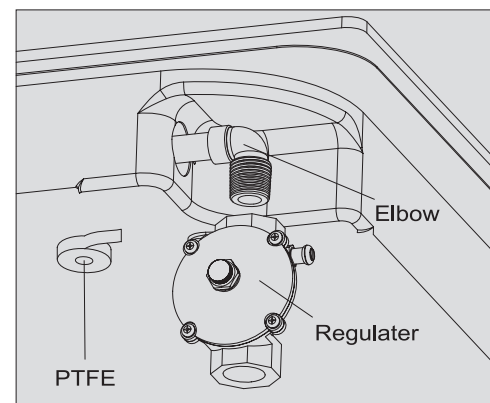

figure 4

■ **This appliance is suitable for use with a flexible hose assembly**

Hose assembly must comply with AS/NZS 1869, 10mm ID, Class B or D, maximum length 1.0m, and installed in accordance with AS/NSZ 5601.1. It should be suitable for connection to a fixed consumer piping outlet located at the region shown in figure 5, and should be suitable for connection to the inlet connection behind the appliance shown in figure 6. The supply connection point can be accessible with the appliance installed.

⚠ **Warning:** Ensure hose assembly is restrained from accidental contact with the flue outlet of an under bench oven.

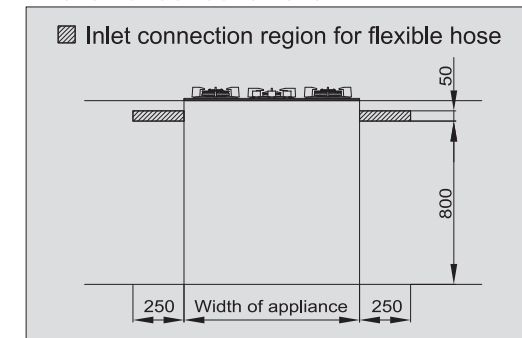

figure 5

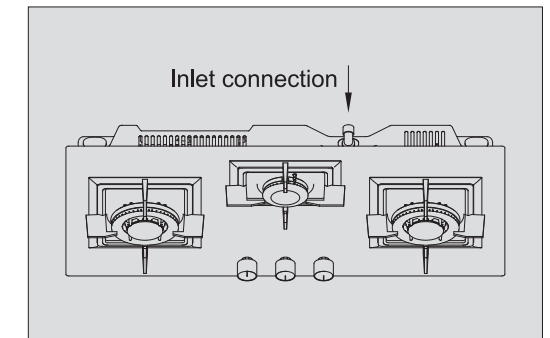

figure 6

INSTRUCTIONS FOR THE USER

■ **About your new cooktop**

The control knobs can be removed for cleaning by just pulling.

■ **Safety feature: flame failure device**

Your cooktop is equipped with flame failure device: the gas supply will automatically be cut off to a burner that is accidentally blown out by a draught or extinguished by a spill.

■ **Specifications and structure**

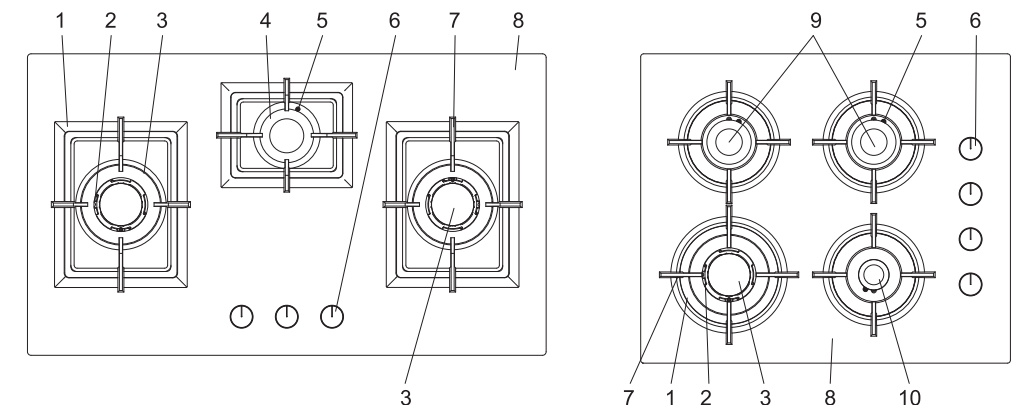

- 1: Liquid Tray 2: Ignition Pin 3: Large Burner 4: Small Burner 5: Thermocouple
- 6: Knob 7: Pan Support 8: Panel 9: Semi-rapid Burner 10: Auxiliary Burner

- a. Be careful the pot (pan) is too heat to cause fire when cooking with vegetable oil and animal fat oil. When cooking with such kind of oil, please don't leave it alone after you put the food into the pot (pan).
- b. The stove will heat when using, please keep it off heating items. Such metal objects as knife, fork, spoon and cover, should not be placed on the stove to prevent heat conduction.

■ Using the gas hob

First of all ,check whether knobs is in the ☉ position (refer to (1)). Then turn on the gas switch, press the stove knobs, contra rotate 90 degrees (refer to (3)), to confirm the flame is lighting up. If the flame extinguishes after your hand off the knobs, then please return the knobs to ☉ position, and repeat the above operation.

After the flame burning, please comply with (2) (3) (4) (5) (6) method to turn knob. You can adjust big or small fire according to the demands. And for the small burner you can get the smallest fire when the knob rotate to the position show in (6).

If you need to stop stove working, please clock wisely turn to ☉ position, then the fire will extinguished (refer to (1)). Then close the general gas valve.

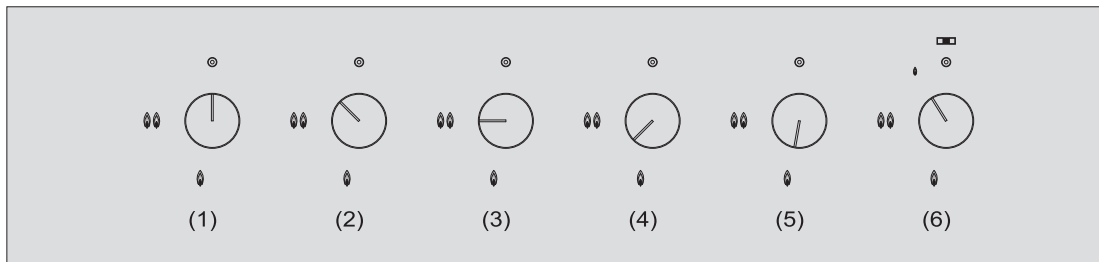

If the flame goes out accidentally a safety device will be tripped about 20 seconds later, and cut off the gas supply even if the gas tap is open. In this case, to turn the knob back to the off position and wait at least 60 seconds before trying to relight the burner.

■ Selection of pans

Please choose the proper pan, and you will enjoy better cooking experience.

1. Please make sure the diameter of the pan used is equal to or more than cook area.
2. To avoid rubbing the surface,using clean and bottom-slick pan.
3. To get best cooking results, the bottom of porcelain enamel steel pan shall be 2-3mm thick, the bottom of stainless steel filled pan shall be 4-6mm thick.

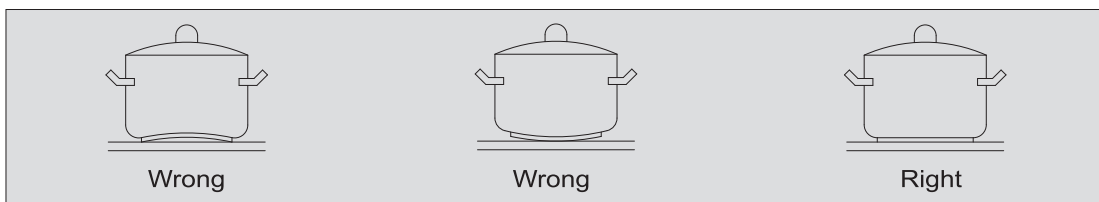

Burner	Minimum	Maximum
Small	N/A	20cm
Large	N/A	27cm

■ Use of mini-pan support

To ensure that the small pan can be stabilized on a pan support, this product is equipped with an additional mini-pan support. Please refer to the installation method on the right to install it.

Notice: GLG60409 does not have mini-pan support.

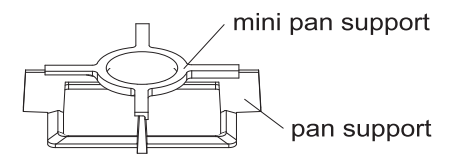

CLEANING AND MAINTENANCE

⚠ Notice

<p>Before cleaning and maintaining the stove, switch off the general gas valve and wait for it cooling down thoroughly.</p>	<p>When you maintain the following, make sure not disassembly the safety device or gas duct parts.</p>	<p>Please contact FOTILE service center if there is abnormality.</p>
---	--	--

■ Check

<p>If the hose is damaged or the emergence of small hole. Please stop using at once and replace it in time.</p>	<p>Never let the spilth block the burner. Make sure there is no food residua, foreign matter and water touch the ignition and thermocouple head.</p>
<p>Please don't stack the inflammable around the gas stove.</p>	<p>The flame should not be irregular.</p>
<p>Burners, flame caps and pan supports shall be correctly positioned.</p>	<p>Check the interfaces with suds frequently to avoid gas leak.</p>



Please don't wipe the stainless steel panel with sharp material like steel wire ball, etc. It will greatly shorten the cooktop lifespan.







Every three months, carry out maintenance on the stove:

1. Clean burner, an ignition needle, thermocouple;
2. Check the connection stove hose is damaged, loose connections;
3. For deep cleansing of the stove panel, remove surface oil.

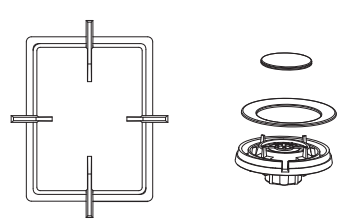
Warning: Service to be carried out only by an authorised person.

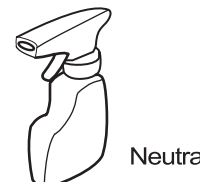
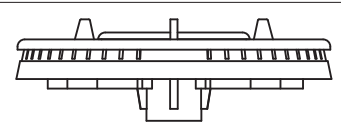
■ Maintenance

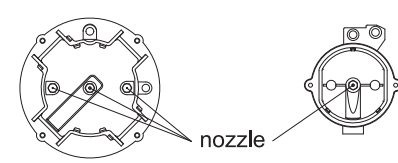
 <p>1. Before cleaning, please take remove pan supports and flame caps.</p>	 <p>Warm water Neutral</p> <p>2. Movable parts of burner like copper flame cap must be washed with warm water and neutral cleanser frequently. Remove the nugget and dry it, then use the stove.</p>
 <p>Neutral</p> <p>3. Please use neutral cleanser which is without corrosiveness, to clean the stainless steel panel and burner. Never use chlorine-base cleanser to clean glass.</p>	 <p>4. Make sure that there is no carbon in the firehole, and no jam.</p>
 <p>Graininess Cleanser Aculeated Articles (Knife etc.) Clean Ball</p> <p>5. Please don't use such aculeated articles as graininess abluent (putty-powder), clean ball, knife, etc. to clean the residual stubborn besmirch in the burners. Otherwise, it will make the kitchen countertop go wrong or fray the assembly surface, then influence cooktop lifespan.</p>	 <p>6. After cleaning, dry them well and install them correctly.</p>  <p>nozzle</p> <p>7. If the flame is abnormal, please check whether the nozzle is blocked, if yes, clean it with the needle. (The needle placed in attachment package)</p>

TROUBLESHOOTING

■ Troubleshooting for gas burner Servicing / repairs must only be carried out by an authorized person

Problems	The cause of problem	Settlements for the problems
It won't fire	It is forgotten to open the general gas valve	Firstly turn off the knob, and then open the general gas valve
	Air is mixed into the gas pipe	Ignite repeatedly until the air is absolutely discharged
	The rubber tube bends or flattens	Unfold or change the rubber tube
	Ignition device and insulation point is dirty and damp	Clean it with a dried cloth
	Safety valve doesn't open	Press and turn the knob to intense fire, make sure the hob is fired and keep on pressing for 3 to 4 seconds
	There's problem with the ignition device or the ignition pin is not in the right position	Ask the professional maintenance man for maintaining
Gas leak	No electricity; Not plug or Plug loose	Reinsert the plug
	The rubber tube cracks or breaks	Change the rubber tube by authorised person
Unstable flame	The rubber tube joint doesn't connect well with rubber tube or other tube	Replace hose
	Whether the LPG is used up	Change into a new bottle of LPG
Soft and yellow flame	The throttle is not properly adjusted, and the air is insufficient	Gradually enlarge the throttle until the flame turns normal blue
The flame escapes from the dire hole or flameout is with fulmination	The throttle is not properly adjusted, and the air is insufficient	Gradually enlarge the throttle until the flame turns normal blue
The flame isn't in uniform length and the flame is yellow	Fire lid is not properly covered, and there's charcoal or other dirt stuffing the fire hole	Make sure that the fire lid is on the right position; get rid of the dirt in the fire hole
The flame accidentally goes red	Under a certain climate, the gas is with much humidity	The flame turns red because there's calcium in water, so don't worry about it

WIRING DIAGRAM

GLG86322 & GLS90303

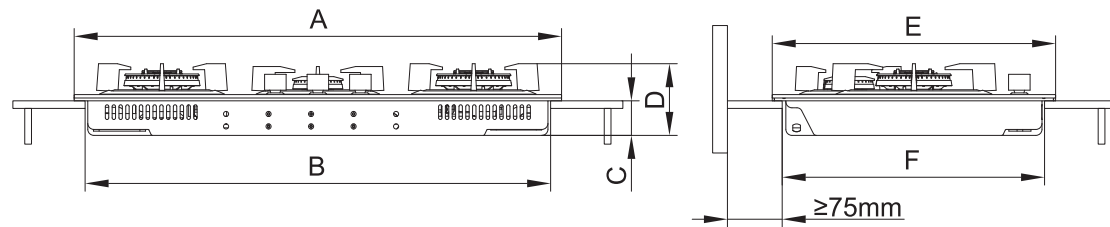

Model	Parameter	A(mm)	B(mm)	C(mm)	D(mm)	E(mm)	F(mm)
GLG86322	220-240V,50Hz	860	816	65	125	500	460
GLS90303	220-240V,50Hz	900	816	65	118	500	460
GLG60409	220-240V,50Hz	613	561	61	126.5	513	481

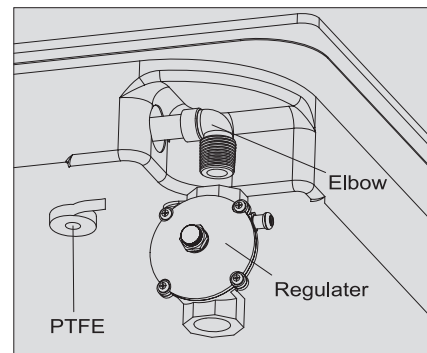

NG/LPG gas inlet connection

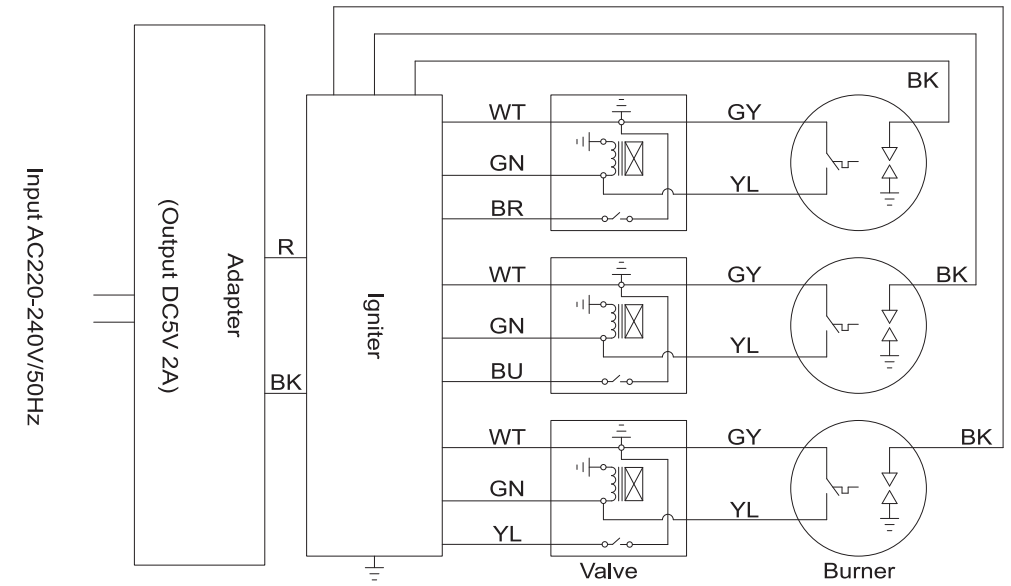

GLG60409

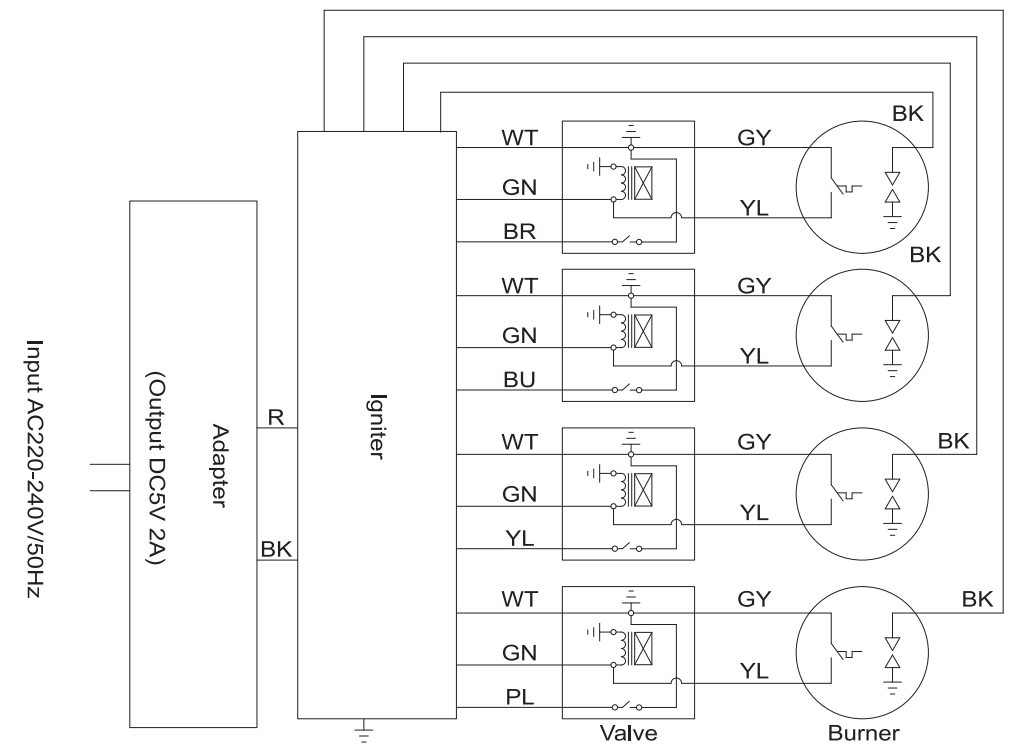

CONVERTING THE COOKTOP FROM NG TO ULPG

All work involved in installation, setting and adaptation to a different gas type must be carried out by authorised personnel from our Service Centre and must comply with current regulations and the conditions laid down by the local gas company. Contact the Distributor to get the parts needed for the conversion. All parts used for the conversion must be the manufacturer's original parts. Before conversion the cooktop must be disconnected from the electricity and gas valves must be turned to the OFF position.

Important : After finishing, stick the sticker, indicating the new gas type, close to the specifications plate.

Replacing the injectors

1. Remove all pan supports, burner caps and distributors.
2. Use a wrench to unscrew the injectors then Replace them. It is important to make sure that the injector does not become detached during removal or fastening. They must be properly tightened to ensure that there are no leaks.

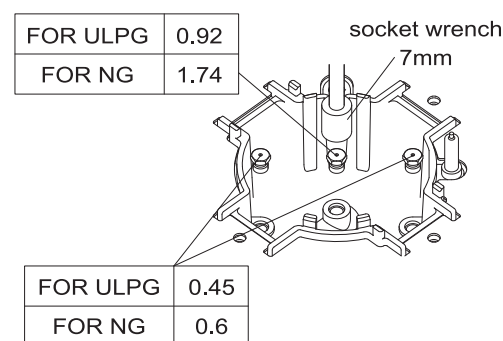

Large Burner

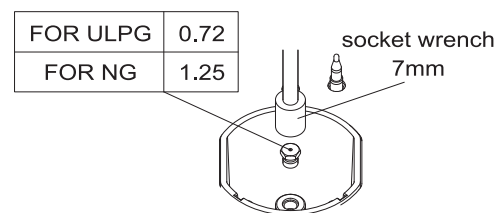

Small Burner

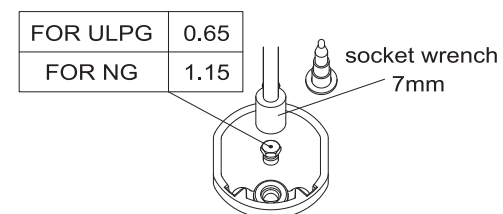

Semi-rapid Burner

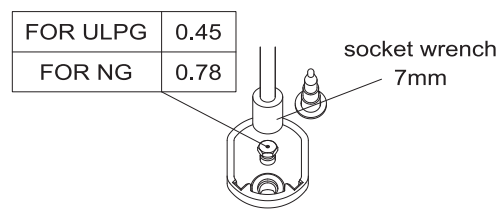

Auxiliary Burner

Adjusting the gas valves

1. Dismantle the removable components of the burners. Remove the panel, all the knobs.
2. Use a screwdriver to adjust the bypass screws. Make sure that the flame does not go out and that there are no flashbacks when you turn the put the burners, the panel and all the knobs back into place correctly.

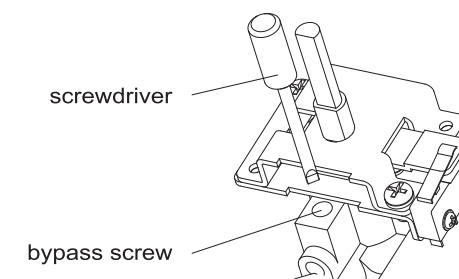

Replacing burner caps

For the bigger burner, the inner ring cap need to be changed from NG to ULPG (For ULPG, it consists of two parts(p1,p2), which is a whole for NG.)

1. When reinstalling the burner, please match the slot S on P4 to the component W on P5 to complete the placement.
2. Put the P3、P2、P1 in turn, and please rotate the P3 360° to ensure it is in the right place.

Note : The picture on the right is the demonstration of correct installation.

