



euro
appliances

Laundry

USAGE AND
CARE GUIDE





PRODUCT
CODE:
EFWD845W



Thank you for choosing this product.

This User Manual contains important safety information and instructions on the operation and maintenance of your appliance.

Please take the time to read this User Manual before using your appliance and keep this book for future reference.

Icon	Type	Meaning
	WARNING	Serious injury or death risk
	RISK OF ELECTRIC SHOCK	Dangerous voltage risk
	FIRE	Warning; Risk of fire / flammable materials
	CAUTION	Injury or property damage risk
	IMPORTANT / NOTE	Operating the system correctly

CONTENTS

1.SAFETY INSTRUCTIONS	1
1.1. General Safety Warnings	2
1.2. During Use	7
1.3. Packaging and Environment.....	8
1.4. Savings Information.....	8
2.TECHNICAL SPETECHNICAL SPECIFICATIONS	10
3.OVERVIEW OF YOUR MACHINE	11
3.1. General Appearance.....	11
4.SETTING UP YOUR MACHINE	11
4.1. Remove the Transit Screws.....	11
4.2. Placing the Machine and Adjusting the Feet	12
4.3. Electrical Connection.....	12
4.4. Water Inlet Connection	13
4.5. Water Draining Connection	13
5.CONTROL PANEL OVERVIEW	14
5.1. Detergent Drawer General View	14
5.2. Sections	15
5.3. Programme Dial.....	15
6.WASHING OPERATION	15
6.1. Sorting Laundry	15
6.2. Explanation of Washing Symbols	16
6.3. Placing Laundry Into the Machine	16
6.4. Choice of Detergent and Placing Into the Machine	16
6.5. Programme Selection	17
7.Additional Functions	17
7.1. Half-Load Detection System.....	18
7.2. Cancelling Programme	21
7.3. Finishing Programme	22
8.PROGRAMME TABLE	23
9.MAINTENANCE AND CLEANING OF YOUR MACHINE	24
9.1. Warning	24
9.2. Water Inlet Filters	24
9.3. Detergent Drawer	24
9.4. Pump Filter	25
10.FLUSH STOPPER / BODY / DRUM	26
11.TROUBLESHOOTING	27
12.AUTOMATIC FAULT WARNINGS AND WHAT NEEDS TO BE DONE	28
13.DESCRIBING THE ENERGY LABEL AND SAVING ENERGY	29

1. SAFETY INSTRUCTIONS

Operating voltage / frequency	(V/Hz) (220-240) V~/50Hz
Total current (A)	10
Water pressure (Mpa)	Maximum 1 Mpa / Minimum 0.1Mpa
Total power (W)	2200
Maximum washing capacity (dry laundry) (kg)	8.0
Maximum drying capacity (kg)	4.5

- Do not install your machine on a carpet or such grounds that would prevent the ventilation of its base.
- The appliance is not intended for use by people (including children) with reduced physical, sensory or mental capabilities, or lack of experience and knowledge unless they have been given supervision or instruction concerning use of the appliance by a person responsible for their safety.
- Children should be supervised to ensure that they do not play with the appliance.
- Call the nearest authorized service centre for a replacement if the power cord malfunctions.
- Use only the new water inlet hose coming with your machine when making water inlet connections to your machine. Never use old, used or damaged water inlet hoses.
- Children should not play with the appliance. Cleaning and user maintenance should not be made by children.

 **NOTE:** For a softcopy of this user manual, please contact the following address: “washingmachine@standardtest.info”. In your e-mail, please provide the model name and serial number (20 digits) which you can find on the appliance door.

To ensure your safety and the safety of others, please read the following safety precautions before using or installing your Washer Dryer.

Your machine is for domestic use only. Using it for commercial purposes will void your warranty.

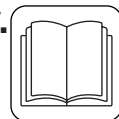

This manual has been prepared for more than one model therefore your appliance may not have some of the features described within. For this reason, it is important to pay particular attention to any figures whilst reading the operating manual.

1.1. General Safety Warnings

Before setting up your Washer Dryer, remove the four transit bolts and the rubber washers from the rear of the machine.

- Your warranty does not cover damage caused by external factors such as fire, flooding and other sources of damage.
- Retain this user manual for future use and pass it on to the next user.
- The necessary ambient temperature for operation of your Washer Dryer is 15-25 °C.
- Where the temperature is below 0 °C, hoses may split or the electronic card may not operate correctly.
- Please ensure that garments loaded into your Washer Dryer are free from foreign objects such as

- nails, needles, lighters and coins.
- Lints must not to be allowed to accumulate around the washer dryer.
 - Residue may build up on detergent and softeners exposed to air for a long period of time. Only put softener or detergent in the drawer at the beginning of each wash.
 - Unplug your Washer Dryer and switch off the water supply if the Washer Dryer is left unused for a long time. We also recommend that you leave the door open to prevent build up of humidity inside the Washer Dryer.
 - Some water may be left in your Washer Dryer as a result of quality checks during production. This will not affect the operation of your Washer Dryer.
 - Keep the document bag that was supplied inside your Washer Dryer and contained this user manual out of the reach of children and babies to prevent the risk of suffocation.
 - The packaging of the machine could be hazardous to children. Do not allow children to play with the packaging or small parts from the Washer Dryer.
 - Only use pre-wash programmes for very dirty laundry.
 - Do not exceed the maximum load for the washing or drying programme you have chosen.
 - In the event of a fault, unplug your Washer Dryer and switch off the water supply. Do not attempt to repair your Washer Dryer yourself. Repairs should only be undertaken by an approved service agent.
 - Never open the detergent drawer while your Washer Dryer is running.
 - Never force the door open when your Washer Dryer is running.

- Please follow the manufacturers' instructions on the use of fabric conditioner or any similar products that you intend to use in your Washer Dryer.
- Do not stop your Washer Dryer before the drying phase of a programme has been completed. If you have to do so, quickly remove all of your laundry and immediately spread the items on an appropriate surface to allow them to cool.
- The appliance must not be supplied through an external switching device, such as a timer, or connected to a circuit that is regularly switched on and off by a utility.
- This appliance must not be installed behind a lockable door, a sliding door or a door with a hinge on the opposite side to that of the washer dryer, in such a way that a full opening of the washer dryer door is restricted.
- Install your Washer Dryer in a location that can be ventilated and has constant air circulation.

SAFETY WARNINGS

- You must read these warnings. Ignoring these warnings may put you or others at risk of fatal injuries.

RISK OF BURNS

- Do not touch the door, drain hose or any discharged water while your Washer Dryer is running. The high temperatures involved pose a burn risk.
- Open the door fully after the drying process. Do not touch the door glass. It will reach high temperatures and pose a burn risk.

ELECTROCUTION RISK

Do not connect your Washer Dryer to the mains electricity supply using an extension lead.

- A damaged power cord/plug can cause fire or give you an electric shock. When damaged it must be replaced, this should only be done by qualified personnel.
- Never remove the plug from the socket by pulling the cord. Always hold the plug.
- Never touch the power cord/plug with wet hands as this could cause a short circuit or electric shock.
- If the supply cord is damaged, it must be replaced by the manufacturer, its service agent or similarly qualified persons in order to avoid a hazard.
- Do not touch your Washer Dryer if your hands or feet are wet.
- Call the nearest authorised service company for assistance if the power cord malfunctions.

Explosion Risk

- Thoroughly rinse off any chemicals, such as stain remover, from your garments before beginning a washing and drying programme. Failure to do so may cause a risk of explosion when the drying function is used.

Fire Risk

- Do not keep flammable or explosive liquids near your machine.
- Items that have been soiled with substances such as cooking oil, acetone, alcohol, petrol, kerosene, spot removers, turpentine, waxes and wax removers should be washed in hot water with an extra amount of detergent before being dried in the tumble dryer.

- Do not use a detergent ball/device if you have selected a washing and drying programme as this may cause a fire hazard.
- Do not dry your laundry under the conditions specified below as they present a fire risk:
 - If the laundry is not washed.
 - If oil based stains are not pre-treated before beginning a washing or drying programme.
 - Laundry which has been cleaned with industrial chemicals.
 - Laundry that has a high amount of sponge, foam, rubber or rubber-like parts and accessories.
 - Items such as foam rubber (latex foam), shower caps, waterproof textiles, rubber backed articles and clothes or pillows fitted with foam rubber pads should not be dried in the drying process of the appliance.
 - Stuffed or damaged items (such as pillows or jackets). The rubber sponge presents a fire risk during the drying process.
- Never use products that contain solvents in your machine.
- Please ensure that garments loaded into your Washer Dryer are free from foreign objects such as nails, needles, lighters, matches and coins.

Fall and Injury Risk

- Do not climb on your Washer Dryer.
- Make sure hoses and cables do not cause a trip hazard.
- Do not turn your Washer Dryer upside down or on its side.
- Do not lift your Washer Dryer using the door or detergent drawer.



- Make sure hoses and cables do not cause a trip hazard.

⚠ To avoid risk of injury, please take care when moving your Washer Dryer. It is heavy and we recommend that a minimum of two people move your Washer Dryer.

⚠ Child Safety

- Do not allow children to play with the machine.
- Do not leave children unattended near the machine. They might lock themselves in the machine.
- The door glass and machine surface can become extremely hot during operation. Do not allow children to touch the machine; it may damage their skin.
- The packaging of the machine could be hazardous to children. Do not allow children to play with the packaging or small parts from the Washer Dryer.
- Poisoning and irritation may occur if detergent or other washing aids are consumed or come into contact with skin or eyes. Keep cleaning materials out of reach of children.

1.2. During Use

- Do not allow pets near the machine.
- Please ensure that you have removed all of the packaging materials and protective tape from the outside of your Washer Dryer, inside the drum and inside the detergent drawer before using. Check for any external visible damage. Do not install or use your Washer Dryer if it is damaged.
- Your Washer Dryer is for domestic use only and is only intended to wash and dry items which are specified by the manufacturer to be machine

washable and dryable on the label and textiles composed of hand washable wool or wool blend fabrics as well as satin, lace, silk and other hand-washable garments. Do not use your Washer Dryer for any purpose not expressly specified in this user guide.

- Installation of your machine must only be carried out by an authorised service agent. Installation by anyone other than an authorised agent will void your warranty.
- Fabric softeners, or similar products, should be used as specified by the fabric softener instructions.

 **WARNING**

- Never stop a tumble dryer before the end of the drying cycle unless all items are quickly removed and spread out so that heat is dissipated.

1.3. Packaging and Environment

DISPOSE OF PACKAGING AND YOUR OLD MACHINE RESPONSIBLY

Removal of packaging materials

Packaging materials protect your machine from any damage that may occur during transportation. Please recycle the packaging materials.

Recycled material reduces raw material consumption and lowers waste production.

1.4. Savings Information

Some important information to get the most efficient use out of your machine:

- The amount of laundry you put in your Washer Dryer should not exceed the maximum amount indicated.

Avoid overloading to allow your machine to run more efficiently.

- Not using the pre-wash feature for normal and lightly soiled laundry will save electricity and water consumption.

CE Declaration of conformity

We declare that our products meet the applicable European Directives, Decisions and Regulations and the requirements listed in the standards referenced.

Disposal of your old machine



The symbol on the product or on its packaging indicates that this product may not be treated as household waste. Instead it shall be handed over to the applicable collection point for the recycling of electrical and electronic equipment. By ensuring this product is disposed of correctly, you will help prevent potential negative consequences for the environment and human health, which could otherwise be caused by inappropriate waste handling of this product. For more detailed information about recycling of this product, please contact your local city office, your household waste disposal service or the shop where you purchased the product.

2. TECHNICAL SPECIFICATIONS

Maximum washing capacity (dry laundry) (kg)	8.0
* Maximum drying capacity (kg)	4.5
Spin speed (rpm)	1400
Number of programmes	15
Operation voltage / Frequency (v/hz)	220-240 / 50
Water pressure (mpa)	Maximum: 1 Minimum: 0.1
Dimensions (HxWxD) (mm)	845x597x582
* You should not put dry laundry in your machine for drying.	
AS/NZS.2040 standard-compliant control programmes	
Washing programme:	
2. Programme "Cotton Eco", temperature 40°C, maximum spinning speed 1400 rpm.	
Drying Programmes:	
1. Drying : 13. Programme "Cotton dry"	
Drying option additional function selection: Drying Option 3 (🌀)	

3. OVERVIEW OF YOUR MACHINE

3.1. General Appearance

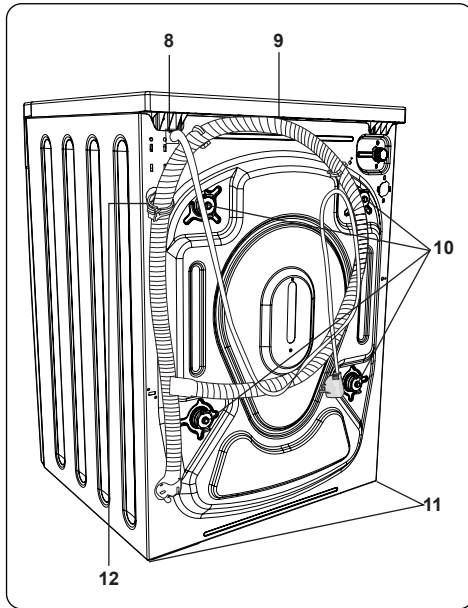
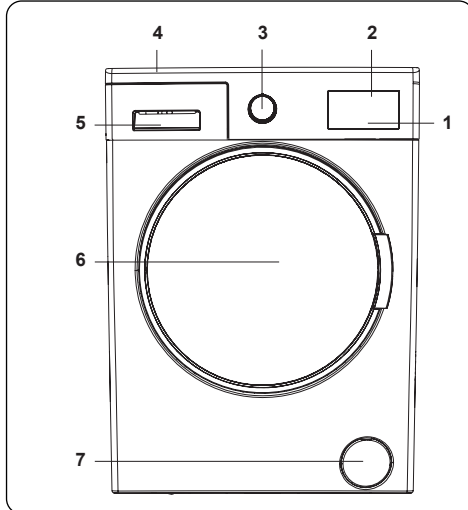

1. Touch buttons
2. High-resolution LCD display
3. Programme Button
4. Upper Tray
5. Detergent Drawer

6. Door
7. Pump Filter Cover
8. Power Cord
9. Drain Hose
10. Transport Screws
11. Adjustable Feet
12. Plastic Drain Hose Holder: (Do not remove the holder; the operation of the machine will be affected).
- 13.

4. SETTING UP YOUR MACHINE

Your machine must only be installed by an authorised service company.

4.1. Remove the Transit Screws

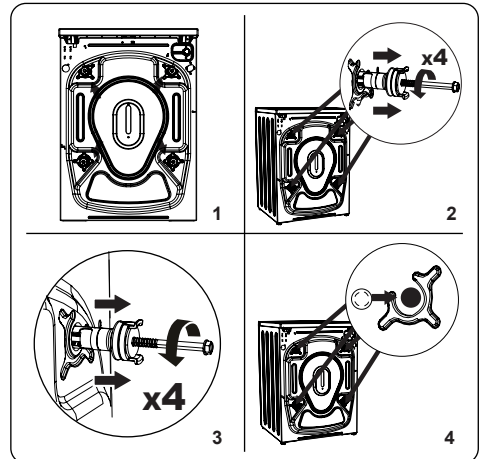

1. Before operating your machine, you must remove the transit screws from the rear of the machine.
2. Loosen the transit screws by rotating anti-clockwise with an appropriate spanner.
3. The transit screws can then be removed with a straight pull. The removed transit screws should be stored in case you need to transport your Washer Dryer in the future.

NOTE: You must remove the transit screws from your machine before first use. Faults occurring in machines operated with transit screws still fitted are outside the scope of the warranty. Fit the plastic blanking caps supplied in the accessories bag into the gaps left by

the removal of the transport screws. The transport screws should be stored for future use.

4. Insert the plastic blanking caps from the accessories bag into the gaps left by the transit screws.

4.2. Placing the Machine and Adjusting the Feet

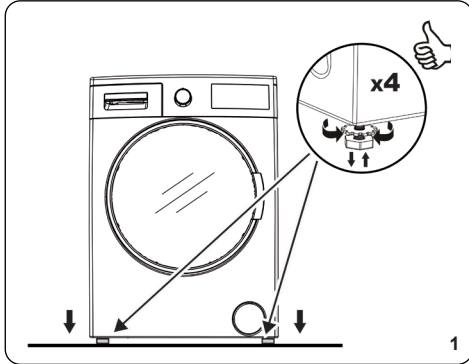

1. Do not install your machine on a carpet or surface that will block ventilation at the base.
2. To ensure silent and vibration-free operation of your machine, install it on a firm surface.

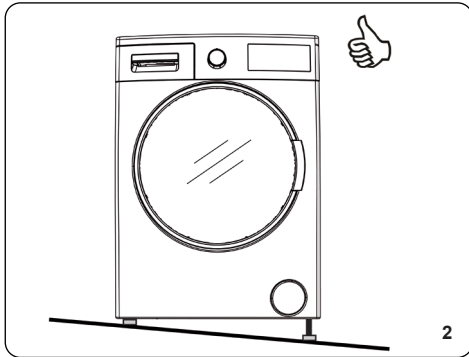

3. You can adjust the level of your machine by using the gauge at the top.

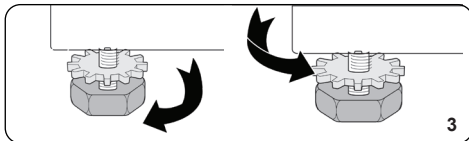

4. You can level your Washer Dryer by using the adjustable feet:
 - Loosen the plastic adjustment nut.

- Turn the feet clockwise to increase the height of the machine. Turn the feet anti-clockwise to decrease the height of the machine.
- Once the machine is level, tighten the plastic adjustment nut.

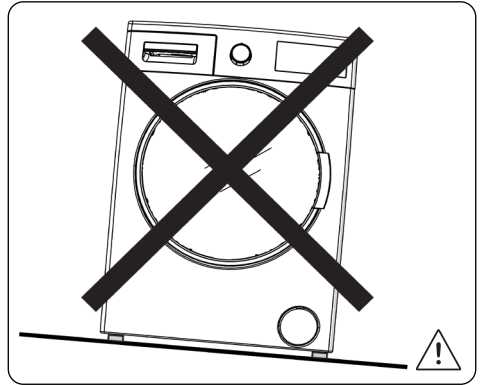

- Never insert cardboard, wood or other similar materials under the machine to level it.
- When cleaning the ground on which the machine is located, take care not to disturb the level of the machine.

4.3. Electrical Connection

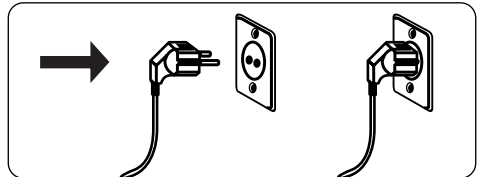

- Your Washer Dryer requires a 220-240V, 50Hz mains supply.
- The mains cord of your machine is fitted with a grounded plug.
- The plug should always be inserted to a grounded socket of 10 amperes. The fuse rating of the plug should also be 10 amperes.
- If you do not have a suitable socket and fuse conforming with this, please ensure the work is carried out by a qualified electrician.
- We do not take responsibility for damage that occurs due to the use of ungrounded equipment.

NOTE: Operating your machine with low voltage will cause the life cycle of your machine to be reduced and its performance to be restricted.

4.4. Water Inlet Connection

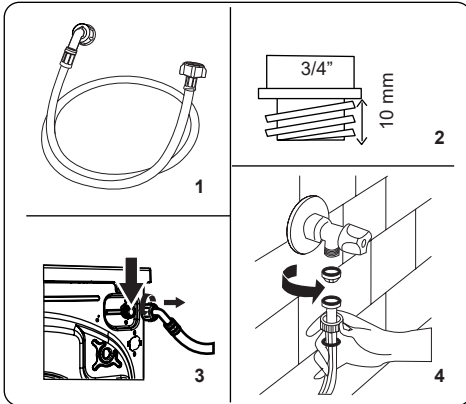

- Connect your Washer Dryer to your cold water supply only.
- Only use the water inlet hose supplied with your machine or one purchased through an authorised dealer.
- A gasket is included in the hose packaging to prevent water leaks from connections. Fit this gasket to the end of the water inlet hose that will be connected to the tap.
- Connect the angled end of the water inlet hose to the cold water inlet on the rear of the machine and hand-tighten.
- Screw the other end of the water inlet hose onto a 3/4" water tap and hand-tighten.

- If in any doubt, consult a qualified plumber.
- Turn the cold water supply on and check for any leaks.
- Water flow with pressure of 0.1-1 Mpa will allow your machine to operate at optimum efficiency (pressure of 0.1 Mpa means that more than 8 litres of water per minute will flow through a fully opened tap).
- Ensure that the the hose is not trapped, kinked, twisted, folded or crushed.

NOTE: Only use the water inlet hose supplied with your machine when making connections. Never use old, used or damaged water inlet hoses.

4.5. Water Draining Connection

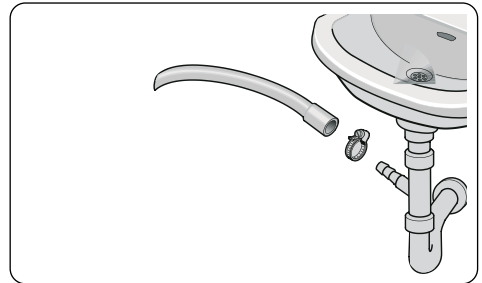

- Connect the water drain hose to a standpipe or to the outlet elbow of a household sink, using additional equipment. The hose must be placed between 0 cm and 80 cm from the ground.
- Never attempt to extend the water drain hose.
- Do not put the water drain hose from

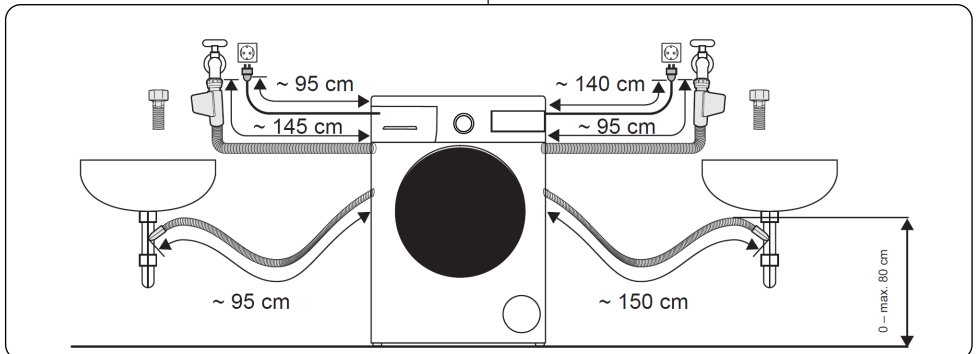

your machine into a container, bucket or bathtub.

- Make sure that the water drain hose is not bent, buckled, crushed or extended.

5. CONTROL PANEL OVERVIEW

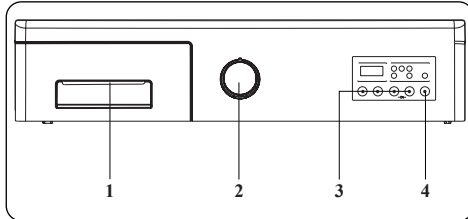

1. Detergent drawer

2. Programme Dial / On-Off button:

Use the programme dial to select the washing / drying programme for your laundry. Turn the programme dial clockwise or anticlockwise to select the required programme. Make sure that the dial is pointing exactly at the selected programme. To turn the appliance on or off, press the on / off button.

3. Additional Function Buttons: Use these buttons to select additional functions for the laundry programme. See Additional Functions for more information.

4. Start/Pause button: Start or pause the selected programme.

5.1. Detergent Drawer General View

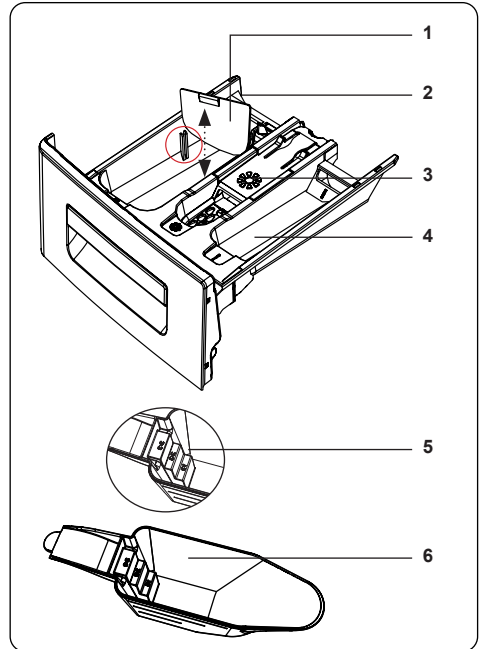
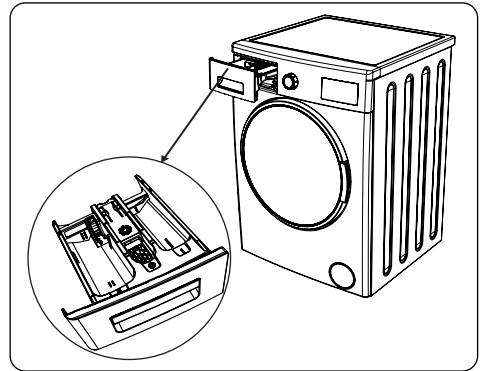

1. Liquid Detergent Attachments (*)

2. Main Wash Detergent Compartment

3. Softener Compartment

4. Pre-Wash Detergent Compartment

5. Powder Detergent Levels

6. Powder Detergent Scoop (*)

(*) Specifications may vary depending on the machine purchased.

5.2. Sections

Main wash detergent compartment:

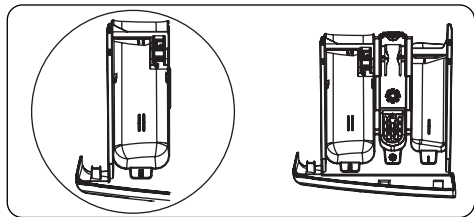

This compartment is for liquid or powder detergents or limescale remover. The fluid detergent level plate is supplied inside your machine. (*)

(*) Specifications may vary depending on the machine purchased.

Fabric conditioner, starch, detergent compartment:

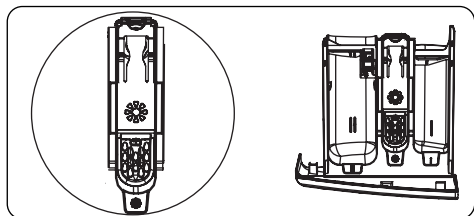

This compartment is for softeners, conditioners or starch. Follow the instructions on the packaging. If softeners leave residue after use, try diluting them or using a liquid softener.

Pre-wash detergent compartment:

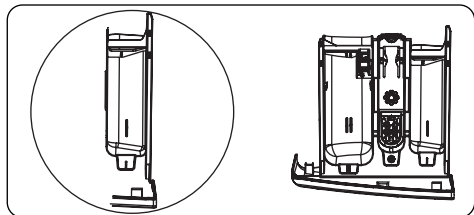

This compartment should be used only when the pre-wash feature is selected. We recommend that the pre-wash feature is used only for very dirty laundry.

5.3. Programme Dial

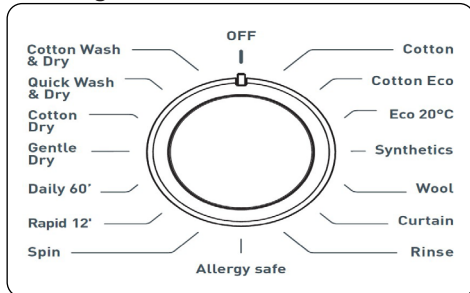

- To select the desired programme, turn the programme dial either clockwise or anti-clockwise until the marker on the programme dial points to the chosen programme.
- To turn the appliance on or off, press the on / off button.

6. WASHING OPERATION

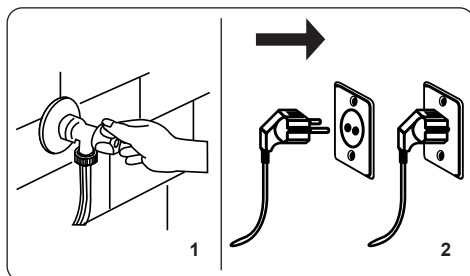

1. Turn on the water supply.
2. Plug in your machine

6.1. Sorting Laundry

! Your laundry contains product labels which specify the appropriate washing instructions. Wash or dry your laundry according to the instructions on the product labels.

- Sort your laundry according to their type (cotton, synthetic, delicates, wool, etc.), washing temperature (cold, 30°C, 40°C, 60°C, 90°C) and the level of dirtiness (less dirty, dirty, very dirty).
- Never wash coloured and white laundry together.
- Dark textiles may contain excess dye and should be washed separately several times before being included in a mixed load.

- Ensure that there are no metallic materials on your laundry or in the pockets; if so, remove them.

! WARNING: Any malfunction occurring due to foreign materials damaging your machine are not covered by the warranty.

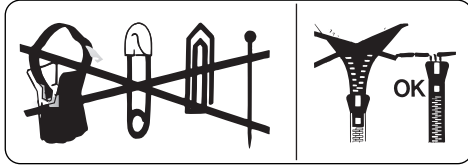

- Close zips and fasten any hooks and eyes.
- Remove the metallic or plastic hooks of curtains or place them in a washing net or bag.
- Reverse textiles such as pants, knitwear, t-shirts and sweat shirts.
- Wash socks, handkerchiefs and other small items in a washing net.

6.2. Explanation of Washing Symbols

	Machine wash		Maximum ironing temperature 110°C
	Machine wash, permanent press		Do not iron
	Maximum washing temperature 95°C		Can be dry cleaned with any solvents
	Maximum washing water temperature 60°C		Can only be cleaned with perchloride, lighter gas, alcohol or R113.
	Maximum washing water temperature 40°C		Can only be cleaned with perchloride, lighter gas, alcohol or R113.
	Maximum washing water temperature 30°C		Do not dry cleaning
	Hand wash		Dry flat
	Do not wash		Drip dry
	Can be bleached in cold water		Line dry
	Do not use bleach.		Tumble dry
	Maximum ironing temperature 200°C		Tumble dry high
	Maximum ironing temperature 150°C		Do not tumble dry

6.3. Placing Laundry Into the Machine

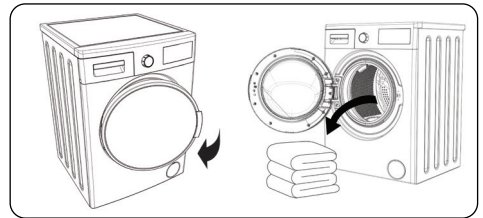

- Open the loading door of your machine.
- Check inside the drum. There may be laundry left inside from previous washes. If there is, empty your machine before selecting a programme.
- Load your laundry into the drum, ensuring it is loosely packed. Fold large objects like quilts and blankets into the drum as shown below.

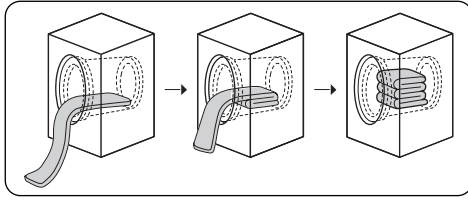

- Place each item of laundry in separately.
- Check that no items of laundry are trapped between the rubber seal and the door.
- Make sure that the door is completely closed or the machine won't start the washing operation.

6.4. Choice of Detergent and Placing Into the Machine

The amount of detergent to use will depend on the dirtiness of your clothes and the hardness of your water supply; guidelines will be on the packaging of your detergent.

- If your clothes are only slightly soiled, do not do a pre-wash. Put a small amount of detergent (as specified by the manufacturer) into compartment II of the detergent drawer.
- If your clothes are excessively soiled, select a programme with pre-wash and put $\frac{1}{4}$ of the detergent to be used into compartment I of the detergent drawer and the rest in compartment II.
- Use detergents produced for automatic washing machines in your machine. Follow the instructions on the detergent packaging when determining the amount of detergent to use for your laundry.
- The higher the degree of hardness of the water, the more detergent you will need.
- The amount of the detergent you will use will increase as the amount of your laundry increases.
- Put the softener in the softener compartment in the detergent drawer. Do not exceed the MAX level, otherwise the softener may flow into the washing water.
- Softeners with high density must be thinned before being put in the drawer. High-density softener will clog the flush and block the flow of the softener.

- You can use liquid detergent in all programmes without pre-washing. Insert the liquid detergent apparatus in compartment II of the detergent drawer and adjust the liquid detergent amount (follow the instructions on the liquid detergent packaging). Do not exceed the MAX level..

6.5. Programme Selection

Turn the dial to select the desired washing programme.

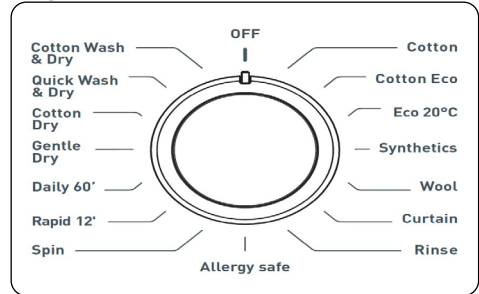

7. Additional Functions

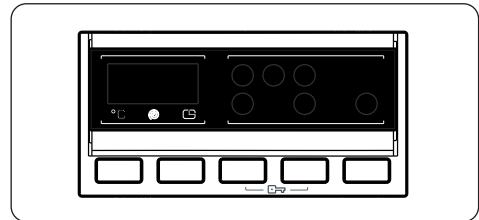

To allow you to get the best washing results possible, your machine offers the following additional functions to complement the selected programme. To select an additional function before starting a programme:

- Press the button on the Control Panel below the symbol of the additional function you wish to select.
- If the symbol of the additional function flashes continuously, the function has been activated.
- If the symbol of the additional function blinks, the function has not been selected.
- Reason for non-activation:
 - The additional function is not compatible with the selected washing programme.

- Your machine has progressed too far into the selected programme for the additional function to be possible.
- The additional function you have chosen is not compatible with another additional function you have already selected.

7.1. Half-Load Detection System

Your machine features a half-load detection system.

If you put less than half the maximum load of laundry into your machine it will automatically set the half-load function, regardless of the programme you selected. This means that the selected programme will take less time to complete and will use less water and energy.

1. Temperature selection

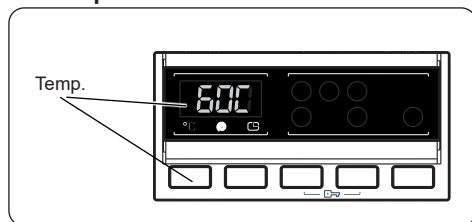

When you select a programme the maximum temperature for that programme is automatically selected.

To adjust the temperature, press the water temperature adjustment button until the desired temperature is displayed on the digital display.

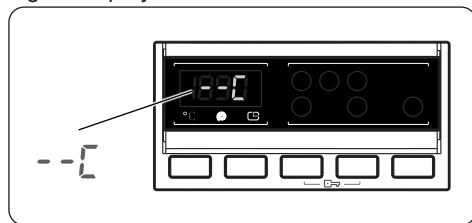

You can gradually reduce the washing water temperature between the maximum temperature and cold washing (--) by pressing the water temperature adjustment button.

If you have skipped the water temperature you want to set, keep pressing the water temperature adjustment button until the desired temperature is displayed again.

2. Spin speed selection

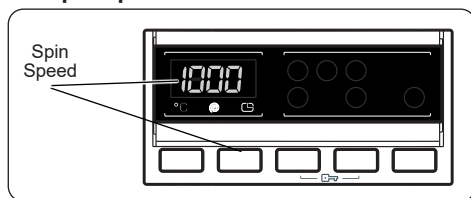

When you select a programme the maximum spin speed for that programme is automatically selected.

To adjust the spin speed, press the spin speed adjustment button until the desired spin speed is displayed on the digital display.

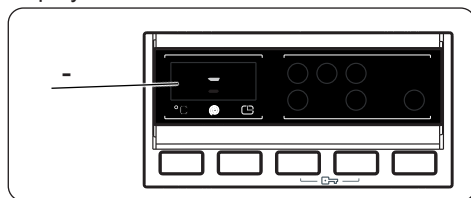

You can gradually reduce the revolution speed between the maximum spin speed and cancel spinning (-) options by pressing the spin speed adjustment button.

If you have skipped the spin speed you want to set, keep pressing the spin speed adjustment button until the desired spin speed is displayed again.

3. Drying option selection:

If you would like your laundry dried at the end of a washing programme, press the drying option button to select the desired drying setting.

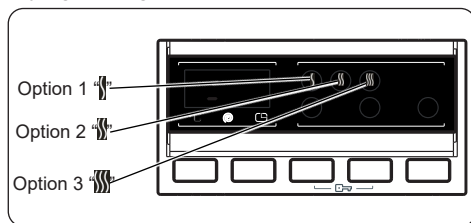

- When you press the drying option button, the option 1 "☼", option 2 "☼☼" and option 3 "☼☼☼" symbols will be shown on the display.
- Option 1 "☼": 100 min. : Recommended for laundry that will be ironed before

using. To select the “☰” drying option, press the drying option button until the “☰” symbol is displayed.

- Option 2 “☱”: 135 min. : Recommended for laundry that requires hanging. To select the “☱” drying option, press the drying option button until the “☱” symbol is displayed.
- Option 3 “☲”: 305 min. : Recommended for laundry that will be folded and put into a wardrobe at the end of the programme. To select the “☲” drying option, press the drying option button until the “☲” symbol is displayed.

NOTE: If one of the above drying option symbols is not displayed when you press the Dry Option button, that drying option is not available for the selected programme.

If you want your laundry dried for a fixed period of time at the end of the washing cycle:

- Press the drying option button to select the desired drying duration.
- When you press the drying option button, the option 1 “☰”, option 2 “☱” and option 3 “☲” symbols will be shown on the display.

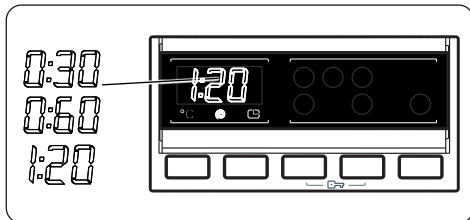
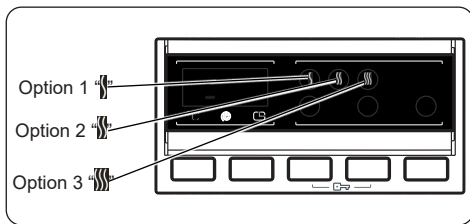

If you continue pressing, duration options (0:30, 0:60, 120 minutes) will be displayed. You can select the drying duration you want.

NOTE: If one of the above drying duration options is not displayed when

you press the Dry Option button, it is not available for the selected programme.

Table: Recommended drying durations for load amounts:

	1 - 2 kg	3 - 4 kg	5 kg
Option 1	✓	✓	X
Option 2	X	✓	✓
Option 3	X	✓	✓

4. Drying option selection:

PROGRAMME	SELECTABLE/ NOT SELECTABLE	DRYING PROFILE	FACTORY PRESET	SELECTABLE OPTIONS		
				Option 1	Option 2	Option 3
Cotton	S	Cotton dry	-	Option 1	Option 2	Option 3
Cotton eco	S	Cotton dry	-	Option 1	Option 2	Option 3
Eco 20°C	S	Cotton dry	-	Option 1	Option 2	-
Synthetics	S	Gentle dry	-	Option 1	Option 2	Option 3
Wool	NS	-	-	-	-	-
Curtain	NS	-	-	-	-	-
Rinse	S	Cotton dry	-	Option 1	Option 2	Option 3
Anti allergic	S	Cotton dry	-	Option 1	Option 2	-
Spin	S	Cotton dry	-	Option 1	Option 2	Option 3
Super Rapid 12'	S	Cotton dry	-	Option 1	-	-
Daily 60'/60°	S	Cotton dry	-	Option 1	Option 2	-
Gentle dry	S	Gentle dry	Option 2	Option 1	-	Option 3
Cotton Dry	S	Cotton dry	Option 2	Option 1	-	Option 3
Quick Wash & Dry	NS	Cotton dry	Option 1	-	-	-
Cotton Wash & Dry	S	Cotton dry	Option 2	Option 1	-	Option 3
S: Selectable NS: No Selection						

Selectable drying duration levels			
Cotton	30	60	120
Cotton eco	30	60	120
Eco 20°C	30	60	120
Synthetics	30	60	120
Wool	-	-	-
Curtain	-	-	-
Rinse	30	60	120
Anti allergic	30	60	120
Spin	30	60	120
Super Rapid 12'	30	60	120
Daily 60'/60°	30	60	120
Gentle dry	30	60	120
Cotton Dry	30	60	120
Quick Wash & Dry	-	-	-
Cotton Wash & Dry	30	60	120

5. Delayed Start

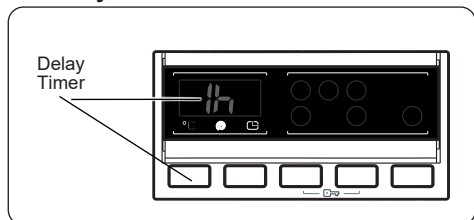

- Press the Delay button once.
- “1 h” will appear on the display.
- The **CL** symbol will flash on the electronic display.
- Press the Delay button until the desired delayed time appears on the display.
- If you have skipped the delay time you wanted to set, keep pressing the Delay button until the desired delay time is displayed again.
- For the delay timer function to work, you must press Start/Pause button.
- To activate the time delay, press “Start/Pause” button.
- To cancel the time delay once it has been set, press the Delay button once. The **CL** symbol will no longer flash on the electronic display.
- In order to add/remove laundry while delay timer function is working, you must press Start/Pause button. After adding/removing laundry, you must press Start/Pause button again to activate delay timer function.

6. Start/Pause button

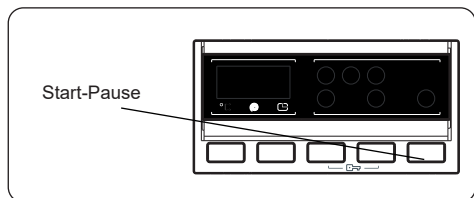

To start the selected programme, press the Start button.

If you switch your machine to standby mode, the Start/Pause indicator on the electronic display will blink.

7. Child Lock

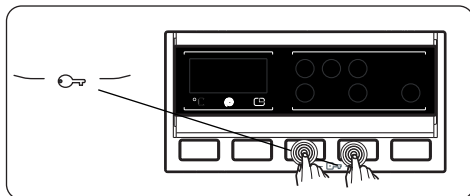

The Child Lock function allows you to lock the buttons so that the wash cycle you have chosen cannot be changed unintentionally.

To activate child lock, press and hold button 3 and 4 simultaneously for at least 3 seconds. “CL” will flash on the electronic display for 2 seconds when the child lock is activated.

If any button is pressed or selected programme is changed by the programme dial while the child lock is active, the “CL” symbol will flash on the electronic display for 2 seconds.

If the child lock function is active and a programme is running, when the programme dial is turned to the CANCEL position and another programme is selected the previously selected programme continues from where it was left.

To deactivate the child lock, press and hold button 3 and 4 simultaneously for at least 3 seconds until the “CL” symbol on the electronic display disappears.

7.2. Cancelling Programme

To cancel a running programme at any time:

1. Turn the programme dial to the “CANCEL” position.
2. Your machine will stop the washing operation and the programme will be cancelled.
3. Turn the programme dial to any other programme to drain the machine.
4. Your machine will perform the necessary draining operation and cancel the programme.

You can now select and run a new programme.

7.3. Finishing Programme

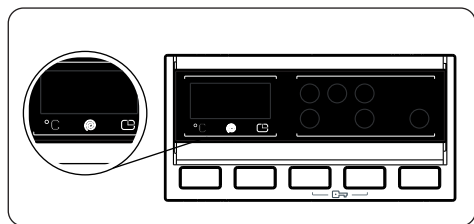

Your machine will stop by itself as soon as the programme you have selected finishes.

- "END" will flash on the electronic display.
- You can open the machine's door and remove the laundry.
- Leave the door of your machine open to allow the inner part of your machine to dry.
- Switch the programme dial to STOP position.
- Unplug your machine.
- Turn the water tap off.

8. PROGRAMME TABLE

Programme	Washing temperature (°C)	Maximum washing / drying capacity (kg)	Detergent compartment	Programme duration (Min.)	Laundry type / Descriptions
COTTON 90° C	90°	8 / 4,5	2	201	Heat resistant, cotton and linen textiles. (Underwear, bed sheets, tablecloths (towels, max. 4.5 kg)
COTTON ECO	40°e	8 / 4,5	2	240	Normally soiled cotton laundry (Underwear, bed sheets, tablecloths (towels, max. 4 kg)
ECO 20°	20°	4.0 / 4.0	2	112	Lightly soiled, cottons and linen textiles (underwear, bed sheets, tablecloth (towel max. 2 kg.) (Bedding, etc.)
SYNTHETICS	60°	3.5 / 3.5	2	120	Synthetics and synthetic blended textiles (synthetic blended shirts, blouses, socks etc.)
WOOLLENS	30°	2.5	2	54	Woolen and wool blended textiles with a machine washable label
CURTAIN	40°	2.5	2	112	Use this programme to wash curtains only.
RINSE	-	8 / 4,5	-	52	Provides an additional rinse to any type of laundry after the washing cycle.
ALLERGY SAFE	60°	4.5 / 4.5	2	248	Baby clothes with a machine washable label.
SPIN	-	8 / 4,5	-	24	Provides an additional spin cycle to any type of laundry after the washing cycle.
SUPER RAPID 12'	30°	2.0 / 2.0	2	12	Lightly soiled, cotton, colored and linen textiles. Due to the short washing time of this programme, we recommend that less detergent is used than with other programmes. The programme may last longer than 12 minutes if your Washing Machine detects an uneven load.
DAILY FAST 60 MIN.	60°	4.5 / 4.5	2	60	Soiled, cotton, colored and linen textiles.
GENTLE DRY	-	3.5	2	100	Delicate laundry bearing the suitable for machine dry label.
COTTON DRY	-	4,5	2	135	Cotton laundry bearing the "suitable for machine dry" label.
QUICK WASH & DRY	30°	0.5 kg, 29 min (3 shirts) (29 minutes)	2	29	Cotton, colored and linen laundry bearing "suitable for machine dry" label Note: Your machine determines the programme duration based on the amount of laundry loaded.
COTTON WASH & DRY	60°	6.0 / 6.0	2	270	Cotton and linen textiles (Underwear, bed sheets, tablecloth, (towel max. 3.0 kg)

! **NOTE:** PROGRAMME DURATION MAY VARY DEPENDING ON THE AMOUNT OF LAUNDRY, TAP WATER, AMBIENT TEMPERATURE AND SELECTED ADDITIONAL FUNCTIONS.

If you select more than one additional function, the functions you select may be incompatible.

Do not dry towels, cotton and linen textiles, synthetic and synthetic blended laundry together. To dry your laundry, select the most appropriate drying programme for the type of the laundry.

9. MAINTENANCE AND CLEANING OF YOUR MACHINE

9.1. Warning

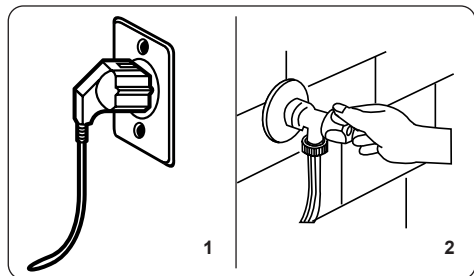

Turn your mains power supply off and remove the plug from the socket before carrying out maintenance and cleaning your machine.

Turn off the cold water supply before starting maintenance and cleaning your machine.

⚠ CAUTION: Do not use solvents, abrasive cleaners, glass cleaners or all-purpose cleaning agents to clean your Washer Dryer. They may damage the plastic surfaces and other components with the chemicals they contain.

9.2. Water Inlet Filters

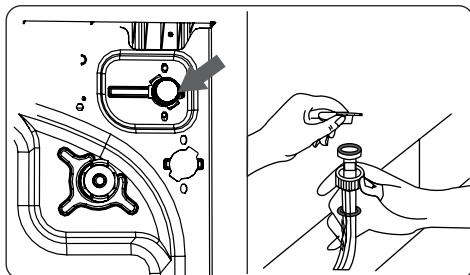

Water inlet filters prevent dirt and foreign materials from entering your machine. We recommend that these filters are cleaned when your machine is unable to receive sufficient water, although your water supply is on and the tap is open. We recommend that you clean your water inlet filters every 2 months.

- Unscrew the water inlet hose from the Washer Dryer.
- To remove the water inlet filter from the water inlet valve, use a pair of long-nosed pliers to gently pull on the plastic bar in the filter.
- A second water inlet filter is located in the tap end of the water inlet hose. To remove the second water inlet filter, use a pair of long-nosed pliers to gently pull on the plastic bar in the filter.
- Clean the filter thoroughly with a soft brush and wash with soapy water and rinse thoroughly. Re-insert the filter by gently pushing it back into place.

⚠ CAUTION: The water inlet filters can become clogged due to water quality or lack of required maintenance and may break down. This may cause a water leak. Any such breakdowns are out of the scope of the warranty.

9.3. Detergent Drawer

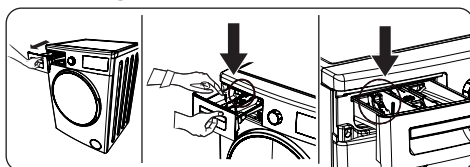

The use of detergent may cause residual build up in the detergent drawer over time. We recommend that you remove the drawer every 2 months to clean the

accumulated residue.

To remove the detergent drawer:

- Pull the drawer forwards until it is fully extended.
- Gently press down on the detergent drawer (as shown above) and pull the drawer from its housing.
- Clean the drawer with water and a soft brush.
- If there is any residue in the drawer housing, remove with a soft brush. Take care to prevent any residue from dropping into the machine.
- Dry the drawer thoroughly and slide it back into the housing.



Do not wash your detergent drawer in dishwasher.

Fluid detergent level plate (*)

Remove the fluid detergent level plate for cleaning and maintenance purposes, as shown and wash off any detergent residue. Slide the fluid detergent level plate back into the guides. Make sure that there is no remaining detergent residue.

(*) Specifications may vary depending on the product purchased.

9.4. Pump Filter

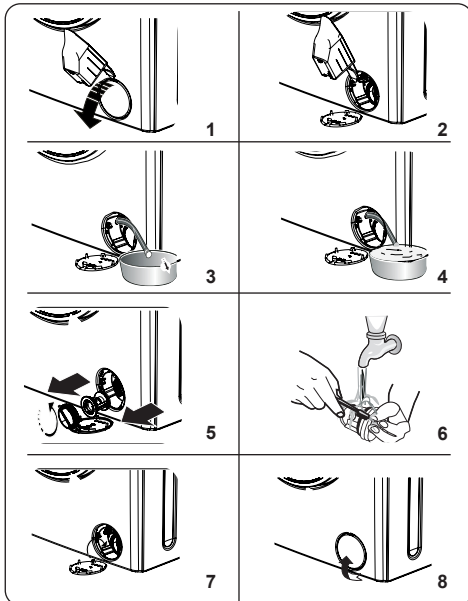

The pump filter system in your Washer Dryer prolongs the life of the pump by preventing lint from entering your machine. We recommend that you clean the pump filter every 2 months.

The pump filter is located behind the cover on the front-lower right corner.

To clean the pump filter:

1. You may use the washing powder spade (*) supplied with your machine or liquid detergent level plate to open the pump cover.
2. Lodge the end of the powder spade or liquid detergent level plate in the opening of the cover and gently press backwards. The cover will open.
3. Pull the black rubber hose forward and detach it from its clamp, place a container under it and remove the plug from the hose.
4. Collect the water drained from your machine in a container.



NOTE: Depending on the amount of water inside the machine, you may have to empty the water collection container a few times.

- Once the water has fully drained, fit the plug back on the hose.
 - Fit the hose back into the clamp.
5. Loosen the filter cover by turning it anticlockwise and remove by pulling.
 6. Remove any foreign materials from the filter with a soft brush.
 7. After cleaning the filter replace the filter cover and tighten by turning clockwise.
 - Please note that the filter cover may leak water unless re-fitted properly.
 8. Close the filter cover.
 - When closing the pump cover, ensure that the mountings inside the cover meet the holes on the front panel of the machine.

10. FLUSH STOPPER / BODY / DRUM

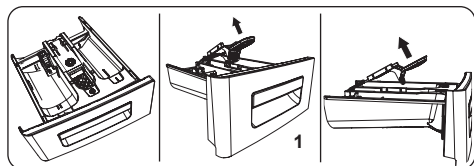

1. Flush stopper

Remove the detergent drawer and disassemble the flush stopper. Clean thoroughly to completely remove any softener residue. Refit the flush stopper after cleaning and check that it is seated properly.

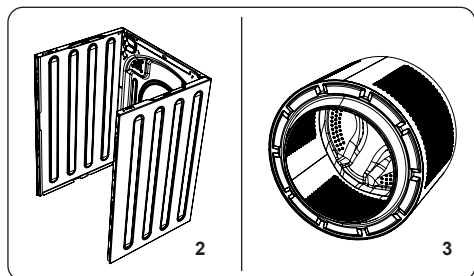

2. Body

Use a mild, non-abrasive cleaning agent, or soap and water, to clean the external casing. Wipe dry with a soft cloth.

3. Drum

Do not leave metallic objects such as needles, paper clips, coins etc. in your machine. These objects lead to the formation of rust stains in the drum. To clean such rust stains, use a non-chlorine cleaning agent and follow the instructions of manufacturer of the cleaning agent. Never use wire wool or similar hard objects for cleaning rust stains.

11. TROUBLESHOOTING

Repair of your machine should be carried out by an authorised service company. If your machine requires repair or if you cannot solve an issue with the information provided below, then you should:

- Unplug your machine from the mains power supply.
- Turn off the water supply.
- Contact the nearest authorised service company.

FAULT	POSSIBLE CAUSE	TROUBLESHOOTING
Your machine will not start.	It is not plugged in.	Insert the plug into the socket.
	The fuse is faulty.	Replace the fuse.
	Mains supply is cut off.	Check the mains supply.
	Start/Pause button is not pressed.	Press the Start/Pause button.
	The programme dial is in the Stop (off) position.	Turn the program dial to the desired position.
	The door of your machine is not closed properly.	Close the door of your machine.
Your machine does not discharge	Drain hose is clogged or twisted.	Check the drain hose.
	Pump filter clogged.	Clean the pump filter.
Your machine vibrates.	The feet have not been adjusted.	Adjust the feet.
	Transit bolts have not been removed.	Remove the transit bolts from your machine
	Your machine only has a small amount of laundry inside.	This will not prevent the operation of your machine.
	Your machine is overloaded with laundry or the laundry is not distributed evenly.	Do not overload your machine. Make sure the laundry is spread out.
	Your machine is located on a hard surface.	Avoid installing your machine on a hard surface. When installing your machine, leave a 2 cm gap between walls or hard surfaces.
Excessive foam is formed in the detergent drawer.	Too much detergent has been used	Press the Start/Pause button. To stop the foam, dilute one tablespoon of softener into 1/2 litre of water and pour into the detergent drawer. Press the Start/Pause button after 5-10 mins
	Wrong detergent used.	Use detergents produced only for automatic washing machines in your machine.
Unsatisfactory washing result.	The laundry is too dirty for the programme you have selected.	Select programmes appropriate for your laundry's level of dirtiness. (See page 21 programme table)
	Not enough detergent used.	Use the amount of detergent as instructed on the packaging
	There is too much laundry in your machine.	Check that the maximum capacity of your Washer Dryer is not exceeded.
As soon as the machine is loaded with water, water discharges.	The end of the water drain hose is too low for the machine.	Set the water drain hose to an appropriate height.
No water appears in the drum during washing.	No fault. Water is in the unseen part of the drum.	- .

FAULT	POSSIBLE CAUSE	TROUBLESHOOTING
There is detergent residue on your laundry after washing	Non-dissolving particles of some detergents may appear on your laundry as white spots.	Perform an extra rinse, or clean your laundry with a brush after it dries
There is detergent residue on your laundry after washing	There is untreated oil, cream or laundry	Use the amount of detergent as instructed on the packaging in the next wash
Spinning operation is not performed or runs late.	No fault. The Unbalanced load control system has been activated.	The Unbalanced load control system will try to spread your laundry evenly. The spinning operation will begin once your laundry is evenly spread. Place the laundry in the machine in a balanced fashion next time.
Laundry remains damp after the drying operation.	Appropriate drying programme is not selected. The maximum load capacity for the selected programme might be exceeded.	Select a drying programme appropriate for your laundry (see page 21 for the programme table)

12. AUTOMATIC FAULT WARNINGS AND WHAT NEEDS TO BE DONE

Your machine is equipped with a built-in fault detection system, indicated by a combination of flashing wash operation lights. The failure codes are shown below.

TROUBLE CODE	POSSIBLE FAULT	WHAT TO DO
E01	The door of your machine is left open.	Shut the door properly until you hear the click. If the fault persists, turn off your machine, unplug it and contact the nearest authorised service immediately.
E02	The water pressure or the water level inside the machine is low.	Check that the cold water tap is fully turned on and that mains water is not cut-off. If the fault persists, your machine will stop automatically. Unplug the machine, turn off the cold water tap and contact the nearest authorised service.
E03	The pump is faulty or pump filter is clogged or electrical connection of the pump is faulty.	Clean the pump filter. If the problem persists, contact the nearest authorised service. (*)
E04	Your machine has excessive amount of water.	Your machine will automatically drain the water. Turn off your machine and unplug it. Turn off the cold water tap and contact the nearest authorised service.

(*) See the chapter regarding maintenance and cleaning of your machine.

13. DESCRIBING THE ENERGY LABEL AND SAVING ENERGY

Energy and water consumption may vary based on water pressure, water hardness, water temperature, ambient temperature, amount of laundry, additional function selection and/or voltage fluctuations.

To reduce energy and water consumption, do not exceed the maximum laundry amounts for the selected programme, wash your laundry when it is lightly soiled or wash your daily laundry in short programmes. Make sure you clean your machine and perform maintenance periodically and use your machine at lower-cost times as specified by your electricity vendor.

A series of horizontal dotted lines for writing or drawing.



Pronto Service + Support: 1800 440 335
Email: service@eurostylegroup.com.au

HEAD OFFICE

65 Glynburn Road, Glynde SA 5070
Ph: 08 8165 1012

www.euroappliances.com.au