



euro
appliances

rangehoods

USAGE AND
CARE GUIDE

PRODUCT
CODE:
EP900UMS2



CONTENTS

Notice	2
Installation	3
Use	3
Notice of Installation	4
Safety Warning	4
Maintenance	5
Abnormity & Solution	7

NOTICE

1. Thank you for choosing our cooker hood. Please read the instruction manual carefully before use.
2. The installation work must be undertaken by a qualified and competent fitter.
3. The manufacturer disclaims all liability for any damage or injury caused as a result of not following instructions for installation contained in the following text.

The cooker hood is used on 220/240V, 50Hz.

Contents

- 1X Rangehood**
- 1X Packet of Screws**
- 1X Operating Instructions**

(1) INSTALLATION

1. The cooker hood should be placed at a distance of 65-75cm (26-30inch) from the cooking surface for the best effect.
2. Drill a hole in the cupboard, with hole wide 490*265 (mm). Make sure it's at least 35mm from the edge of the hole to the cupboard edge.
3. Take down the filter and remove the 2 (M4 x 10mm)screws on the panel.
4. Use random accessory tighten 8 screws (ST4 x 18mm) fix the hood into cabinet.
5. Use 2 screws(M4 x 10mm) fix the panel into body and equip the filter.
6. Install one-way valve: put the one-way valve into air outlet, Put on the one-way valve with air outlet.

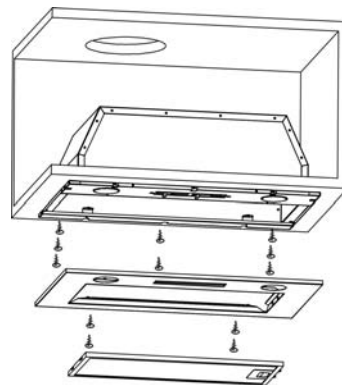
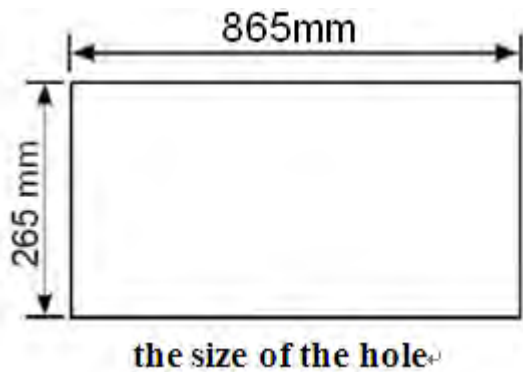
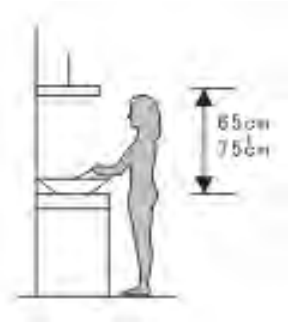

1. Push stop button, and the motor will stop.
2. Push the Low button, the motor runs at low speed.
3. Push the Mid button, the motor runs at mid speed.
4. Push the High button, the motor runs at high speed.
5. Push the light button and the two lights will come on.
6. Push it again and the light will turn off.

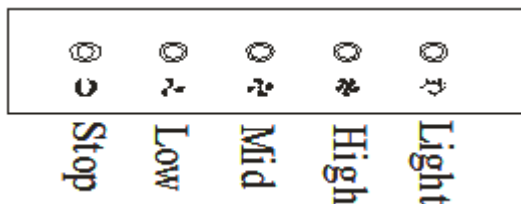

Explain the Instructions:

- a. Connection of the appliance to the supply mains.
- b. Necessity to allow disconnection of the appliance from the supply after installation. Disconnection may be achieved by having the plug accessible or by incorporating a switch in the fixed wiring in accordance with the wiring rules.

Warning: Failure to install the screws or fixing device in accordance with these instructions may result in electrical hazards.

(3) NOTICE OF INSTALLATION

1. Before installation, please ensure the area is clean to avoid suction of the remaining bits of broken wood and dust.
2. The air must not be discharged into a flue that is used for exhausting fumes from appliances burning gas or other fuels.
3. The bending of ventilation tube should be $\geq 120^\circ$, parallel or above the start point and should be connected to the external wall.
4. After installation, make sure that the extractor is level to avoid grease collection at one end.

Installation warnings

- a. There shall be adequate ventilation of the room when the range hood is used at the same time as appliances burning gas or other fuels.
- b. Regulations concerning the discharge of air have to be fulfilled.

(4) SAFETY WARNING

1. Never let the children operate the machine
2. The cooker hood is for home use only, not suitable for barbecue, Roast shop and other commercial purpose.
3. Please ask the technical person to do the assembling.
4. The cooker hood and its filter mesh should be clean regularly in order to keep in good working order.
5. Before cleaning, please switch the power off at the main supply.
6. Clean the cooker hood according to the instruction manual and keep the cooker hood from the danger of burning.
7. If there is any fault with the appliance, please call the service department to arrange a service engineer.
8. There is a fire risk if cleaning is not carried out in accordance with the instructions.
9. Do not flambé under the range hood.

CAUTION:

Accessible parts may become hot when used with cooking appliances. This appliance is not intended for use by persons (including children) with reduced physical, sensory or mental capabilities, or lack of experience and knowledge, unless they have been given supervision or instruction concerning use of the appliance by a person responsible for their safety. Children should be supervised to ensure that they do not play with the appliance. If the supply cord is damaged, it must be replaced by the manufacturer, its service agent or similarly qualified persons in order to avoid a hazard.

(5) MAINTENANCE

1. The cooker hood and its filter mesh should be cleaned regularly in order to keep in good working order. Because the grease filters are made of metal, do not clean the filters with detergents that will corrode metal products.
2. Clean the filters as below:
 - a) Method one:
Put the filter in the water(40°C-50°C), pour in some grease-loosening detergent, soak it for about 2-3 minutes and then clean it with a soft brush. Do not brush too hard, in case to damage the filter.
 - b) Method tow:
User can put the filter into a dishwasher with detergent for cleaning. Set the temperature at around 60°C.
3. To protect the main body from corrosion over a long period of time, the cooker hood should be cleaned with hot water plus soap or non corrosive detergent once a week. Do not use grinding detergent, or it will damage the body.
4. Keep the motor and other spare parts free from water, as this will cause damage to the appliance.
5. Disassembly and assembly the filter:

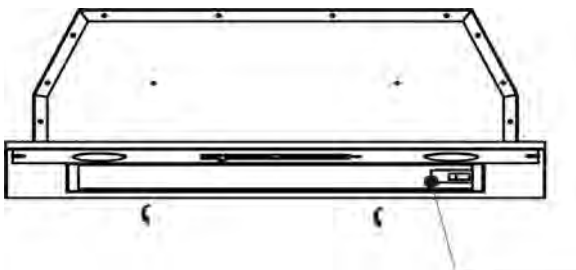

6. Activated carbon filter can be used to trap odors. In order to install the activated carbon filter, user have to unscrew and take down the front panel. Then plug the activated carbon filter into the unit and turn it in anti-clockwise direction. Repeat the same on the other side.

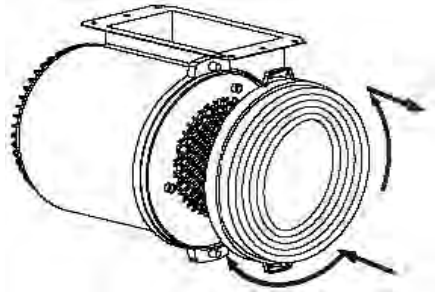

NOTE:

Make sure the filter is securely locked. Otherwise, it could loosen and cause damage to the unit. When activated carbon filter attached, the suction power will be lowered.

7. To change the bulb, press the lamp cup, take out the bulb in the counter-clockwise.

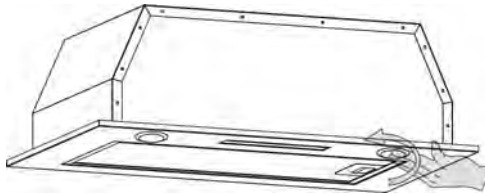

(6) ABNORMITY AND SOLUTION

Fault	Cause	Solution
Light does not work, but motor work	The bulb damaged	Change bulb
	Bulb contact lamp cap bad	Fix or change
	Light panel switch damage	Fix or change
Light work, but motor does not work	Bulb contact lamp cap	Restart later
	Motor bearings damage	Change motor
	Motor burn out	Change motor
	Motor control switch damage	Fix or change
Light does not work, motor does not work	Plug contact outlet bad	Fix or change
	Power wire cut off	Change power wire
	Switch damage	Fix or change
Shake of the body	Wind leaves damage	Change leaves
	Motor screw loosen	Screw it tight
	Combination screw loosen	Screw it tight
	Body hang unfixable	Tight the body
Insufficient suction	The distance between the body and the gas top too long	Readjust the distance
	Cross-ventilation too strong or too closed in the kitchen	Reduce cross-ventilation or open the window
	Exhaust pipe too long	Adjust the length of pipe
	Air outlet valve not open	Check the valve if flexible
	The outside wind is too strong	No the technical problem



Pronto Service + Support: 1800 440 335
Email: service@eurostylegroup.com.au

HEAD OFFICE

65 Glynburn Road, Glynde SA 5070
Ph: 08 8165 1012

www.euroappliances.com.au