

The logo for CHI Q, featuring the letters 'CHI' in a bold, sans-serif font followed by 'Q' in a smaller, regular weight, all in white. The logo is set against a solid black rectangular background.

CHI Q

▶ **USER MANUAL**









MODEL

WTL80W

WTL79B

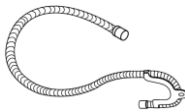

PACKING LIST

Automatic washing machine	User's manual	Water inlet hose set (Cold water)	Water inlet hose set (Hot water)	Bottom plate
1set	1copy	1pcs	1 pcs	1pcs
				
screw	Drain hose		Hose clamp	
1pcs	1pcs	1pcs		
				

SPECIFICATIONS

Model	WTL79B	WTL80W
Rated washing capacity (kg)	8.0	8.0
Rated spinning capacity (kg)	8.0	8.0
Rated voltage / frequency	220~240V/50Hz	220~240V/50Hz
Rated washing power (W)	300	300
Washing container rated capacity (L)	74	74
Net weight (kg)	38.0	38.0
Noise level (washing) (db A)	62	62
Noise level (spinning) (db A)	72	72
Water inlet pressure (Mpa)	0.03~0.8	0.03~0.8
Degree of waterproof	IPX4	IPX4
Unit dimensions (W*D*H mm)	580X625X960	580X625X960

AUTOMATIC WASHING MACHINE

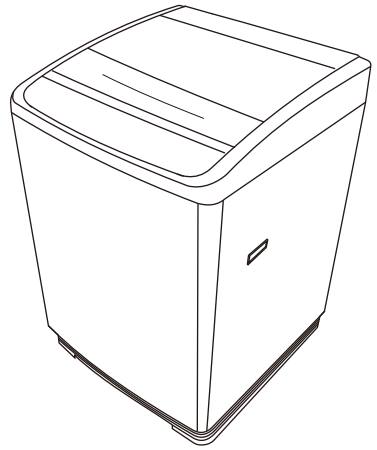

TABLE OF CONTENTS

▪ SAFETY INSTRUCTIONS -----	1
▪ DESCRIPTION OF PARTS-----	2
▪ INSTALLATION-----	3-4
▪ WATER CONNECTION-----	5
▪ DRAIN HOSE SETTING-----	6
▪ CHECKING BEFORE WASHING AND CARE FOR GARMENTS-----	7-9
▪ CONTROL PANEL-----	10-11
▪ HOW TO WASH AUTOMATICALLY DEPENDS ON THE LAUNDRY-----	12
▪ WASHING PROCEDURE-----	13-14
▪ MANUAL FUNCTION -----	14
▪ MAINTENANCE-----	15-16
▪ ERROR CODES-----	17
▪ TROUBLE SHOOTING -----	17-18

**PLEASE READ CAREFULLY THIS USER'S
MANUAL BEFORE USING YOUR WASHER
AND SAVE THIS FOR FUTURE REFERENCE.**

SAFETY INSTRUCTIONS

Please note that the following precautions for safety intend to prevent unpredictable danger and damage by helping the proper use in safety.

When using hot water in washing, please make sure that the water should not exceed 50°C.

☞ Plastic parts may be deformed or damaged, and an electric shock or a fire may take place.

WARNING

There might be serious injury or fatal accident when you violate those instructions.

If the power supply cord or plug is damaged or loosened, do not use.

☞ An electric shock or a fire may take place.

Do not pull the cord off or touch it with moist hands.

☞ An electric shock or a fire may take place.

Do not bend the power supply cord by force or press it with heavy things.

☞ An electric shock or a fire may take place.

Do not install the washer nearby electric implement or don't put a candle light or cigarette light on the washer.

☞ A fire may take place.

Do not disassemble, repair or remodel it recklessly. When you need to repair it, please call service agent.

☞ An electric shock or a fire may take place.

During operation, do not put your hands or metal materials under the washer.

☞ You may be hurt by spinning board beneath the washer.

Stay away from the washer when the bottom of the washer sinks into the water.

☞ There might be an electric shock. Please wait until the water drains out completely.

Do not put laundry stained with gasoline, benzene, or alcohol in the washer, and keep the materials away from the washer.

☞ An explosion or a fire may take place.

During spinning, don't put your hand in the spinning tub.

☞ It may hurt your hand. If it does not stop within 15 seconds after you open the lid, call service agent immediately.

CAUTIONS

There might be a slight injury or damage when you violate those instructions.

Do not install it in the area with moisture or outdoor where it has rain or snow.

☞ An electric shock or a fire may take place.

Please unplug the power supply cord when you do not use it.

☞ An electric shock or a fire may take place.

If there is dust or water on the power supply plug and its connected part, please remove it completely.

☞ An electric shock or a fire may take place.

Do not make your kids look into the inside of the washer.

☞ If your kid falls into the washer, his life could be in danger.

Ventilate immediately without touching the power plug if gas is leaking.

☞ An exploding or a fire may take place if gas catches flame.

If the washer makes strange noise, smell or smoke, unplug it promptly and call service agent.

☞ An electric shock and a fire may take place.

When cleaning, do not spray water to the parts of the washer directly.

☞ It may make its life span shorten.

☞ Also an electric shock or a fire may take place.

Do not use several appliances together with an outlet.

☞ A fire may take place due to unusual heat.

Do not press the button with an awl or pin.

☞ An electric shock or a fire may take place.

Use the new water inlet hose-sets and old hose sets should not be reused.

If the damage is found on the power cord in use, it should be replaced by manufacturer, service agent or authorized person.

☞ An electric shock may take place.

The power receptacle must be grounded properly.

☞ An electric shock or a fire may take place.

DESCRIPTION OF PARTS

The User's Manual is for common use.

Make use of the User's Manual depending upon your washing machine model.

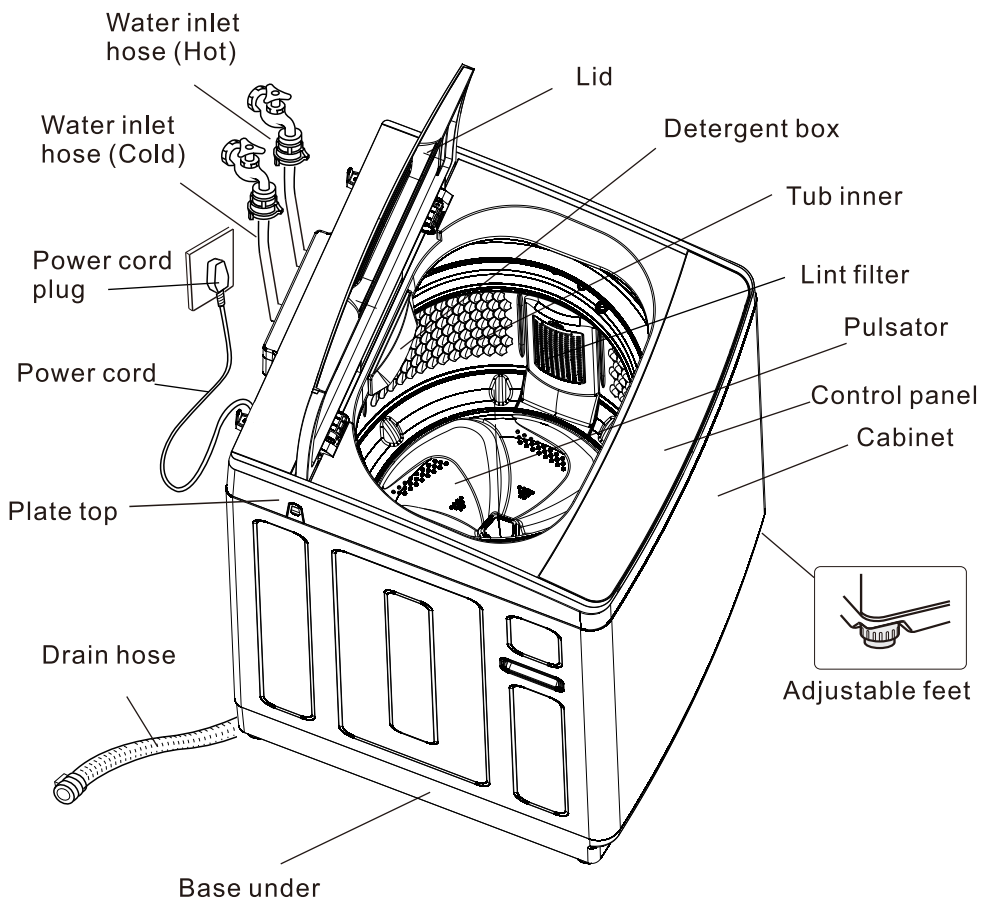

INSTALLATION

The User's Manual is for common use.

Make use of the User's Manual depending upon your washing machine model.

➤ ENVIRONMENT

Leave some space

Maintain at least 10cm between the washer and the wall.

Place the washer on a sturdy flat surface

If the washer is placed on an uneven or weak surface, noise or vibration occurs. (Max. tilt angle on the supporting surface: 2°)

Adjust the legs for even placement

Never install the washer near water

Do not place the washer in steamy rooms or where the washer is directly exposed to rain. Moisture may destroy the electrical insulation causing an electrical shock hazard.

Avoid direct sunlight or heater

As plastic and electrical components are affected by direct heat, never place the washer near furnaces, boilers, etc. Do not place the washer under direct sunlight.

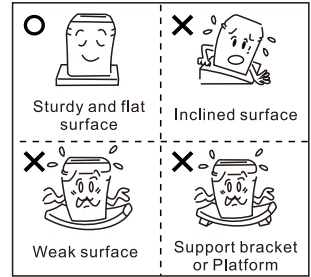

➤ ASSEMBLING THE BOTTOM PLATE

1. Place the washing machine on the soft laying cloth, the front side of the machine is towards the upper.
2. Insert the bottom plate into the slots on the base under, and then tighten it with screw.

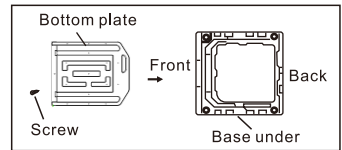

➤ LEVELING THE WASHER

- If the washer is not leveled with the ground, it makes the machine tremble more or be out of order. So, make sure that the washer is leveled properly.

■ SEE IF THE MACHINE IS PLACED LEVEL BY CHECK THE POSITION OF THE WASHING TUB

- Open the lid of the machine, pour water into the tub up to the level just below the pulsator, and adjust the adjustable feet so that the pulsator is positioned at the center of the water as shown in the figure.

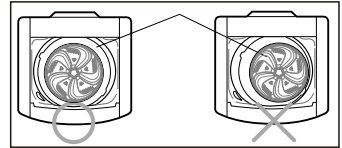

■ ADJUST THE INSTALLATION POSITION

If the floor is uneven, adjust the adjustable feet of the washing machine to level position.

Lift the adjustable feet up slightly and turn the feet to level position.

- The distance between the washing machine and wall: at least 10cm.
- Max. tilt angle on the supporting surface: 2°.

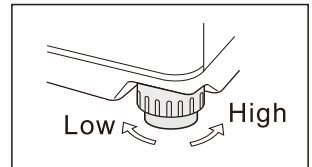

➤ ATTENTION

- When installing the machine, it is need to remove two of the packing parts, include base packing and tub support as shown in the figure . Otherwise, the washing machine will not run normally.
- During the installing the washer or in the first using the washer, there may be some water flow out of the drain hose, which is the residual water at the step of inspection by the factory.
- After washing, be sure to pull off the power plug, close the water faucet, avoid an electric shock or a fire to take place, avoid water leakage to take place.

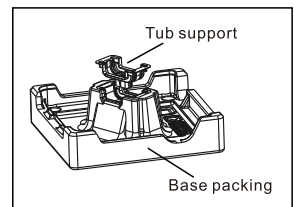

INSTALLATION

The User's Manual is for common use.

Make use of the User's Manual depending upon your washing machine model.

➤ POWER SUPPLY

Before plugging the power cord plug into the wall receptacle, check the voltage rating is in the range of rating, marked on the label at the back side of the washer.

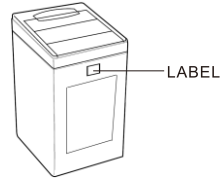

➤ GROUNDING

- If your water faucet or water pipe is not made of metal, connect the ground wire to a copper plate or a metal rod and bury it in the earth.

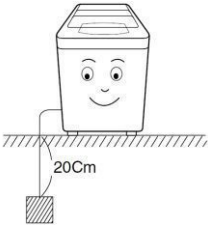

- If both your water faucet and water pipe are made of metal, connect the ground wire to the base of the water faucet.

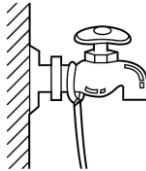

- It is of no use connecting the ground wire to the water pipe made of plastic.

- In case of using 3-core cord, there is no need for grounding.

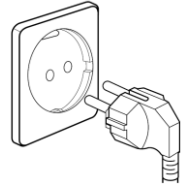

➤ NEVER CONNECT THE GROUND WIRE TO SUCH A THING

- Never connect it to a gas pipe because of danger of an explosion.

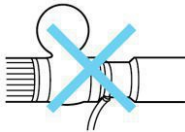

Gas Pipe

- Never connect it to a telephone wire or a lightning rod because of very dangerous at a thunderbolt.



Telephone Wire

WATER CONNECTION

The User's Manual is for common use.

Make use of the User's Manual depending upon your washing machine model.

Be careful not to confuse hot water inlet (pink color) and cold water inlet (blue color), if your washer is provided with dual water inlets. Also if you have only one water tap, connect the inlet hose with cold water inlet (blue color).

➤ CONFIRMING THE WATER FAUCET

Water faucet type, as shown in the right figure:

Type A: This type is suitable. It is a special faucet for washer using.

Type B: This type is suitable. It is required that the front end of the faucet shall be longer than 10mm. The exit end surface of the faucet must be flat and smooth. Otherwise it may leak water. Please file the end surface to avoid leakage.

Type C: This type faucet is not suitable, there may be leakage in the place shown in the figure.

If the water faucet is not suitable, it is needed to replace a suitable water faucet before connecting the water supply hose.

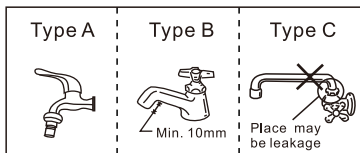

➤ CONNECTION THE WATER SUPPLY HOSE

Connect the other end of the water supply hose to the inlet water valve at the back of the washer. Screw the hose clockwise all the way in.

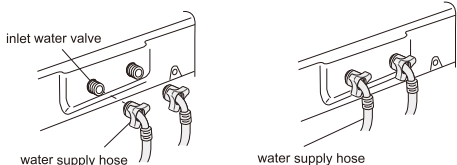

plan B

1. Remove the adaptor from the water supply hose
2. First, using a "+" type screw driver to loosen the four screws on the adaptor. Next, take the adaptor and turn part (b) following the arrow for gap about 5mm between them.
3. Connect adaptor to the water tap by tightening the screws firmly. Then, turn part (b) following the arrow and put part (a) and part (b) together.
4. Connect the water supply hose to the adaptor. Pull down the part (c) of the water supply hose. When the part (c) is released, the hose is automatically connected to the adaptor making a 'click' sound.

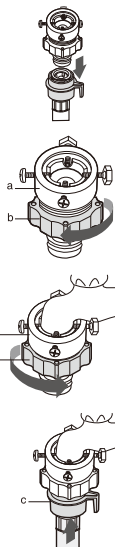

plan A

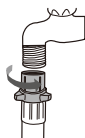

If the water tap is a screw type, assembly a water supply hose that fit to the tap as shown.

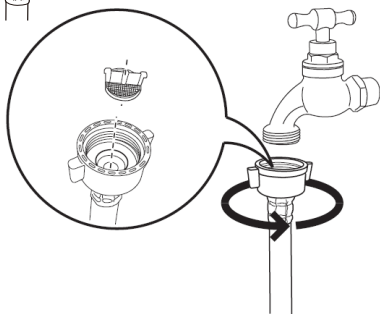

NOTICE:

- After completing connection, if water leakage from the hose, then repeat the same step.
- Use the most suitable type of faucet for water supply.
- If the end of the faucet is square or too big, please loosen the four screws and take out the bushing in the adaptor before inserting the end of the faucet into the adaptor.

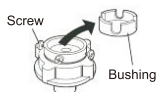

➤ LEAK TEST

Turn on the water completely to check for any leakage. If there are any leakage, turn off the water supply, try again as the above procedures.

For the special tap, call a qualified plumber for the installation.

DRAIN HOSE SETTING

The User's Manual is for common use.

Make use of the User's Manual depending upon your washing machine model.

- Connect the drain hose to the drain outlet at the side of the washer, and fasten it tightly with the hose clamp supplied.

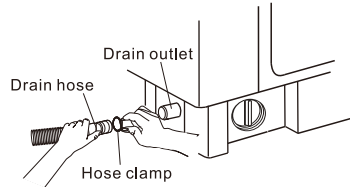

- The washer should be installed in its final position such that the drain hose is not kinked or trapped.
- The corrugated drain hose should be inserted into suitable drain pipe of between 50cm and 85cm height above the floor using the curved drain hose support, the minimum inner wide or diameter of drain pipe should be 4cm.
- If an under sink connection is used the drain hose must be routed above the sink overflow vent to prevent siphoning.
- The drain hose should not be submerged in the water to prevent siphoning.
- Care must be taken to avoid kinking or trapping the drain hose.
- The drain hose must be fixed reliably to avoid leaks or spills .

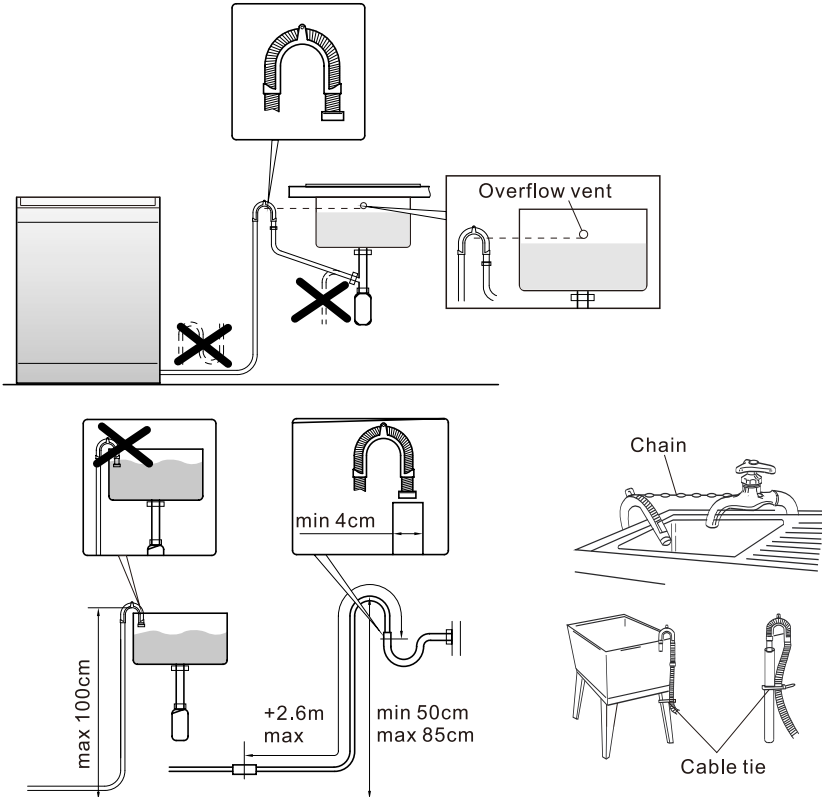

CHECKING BEFORE WASHING AND CARE FOR GARMENTS

Must follow the checkpoints in order to avoid machine problem or damage on garments

☞ If the below problems are caused by customer's faults, separate service fee will be charged.

Checkpoints Before Starting Washing

Check if the clothes are bleaching or not.

- ☞ Add liquid detergent to a white towel and the garment where you can't notice well. Then, rub together strongly. Check if the color transferred to towel.
- ☞ Be careful for scarves and imported clothes since they are easily discoloring.
- ☞ Check for stains or partial dirt.
- ☞ If stains are found, use the towel wet with detergents to rub on in a single direction.
- ☞ Before washing, the sleeves, collar, dress hem and pockets are pre-treated by brushing with detergents.

The wrinkle-processed clothes made of wool are specially treated by fixing them with threads before washing. The threads shall be removed after the clothes are dried.

Not Washable Laundry

Clothes those are easily transformable even by soaking in water.

- ☞ Even by soaking in water, neckties, brassieres, jackets, suits and coats can be easily transformed like shrinking and discoloring on the garment surfaces because they are mostly made of rayon, polynosic, cuff and their blend fabrics.
- ☞ The wrinkle-processed, embossed, or resin processed products are easy to transform even by soaking in water.
- ☞ Easily discoloring products made of cotton and wool, wrinkled silk, leather products, leather accessory, leather ornamented clothes and its accessory.
- ☞ Do not wash those clothes without handling guideline or material indication tag.

About Detergent

- ☞ When detergents are not dissolving well, use warm water (about 40°C) to dissolving the detergent.

Caution

- ☞ Use an appropriate amount.
- ☞ Even if excess amount of detergent is used, there is not much more difference in washing result. It may cause damage to the garments because rinsing is not enough.
- ☞ The bleaching agent may cause damages to garments since it is strong alkali.
- ☞ Do sufficient rinsing because the powder detergent is easily remained on the garments causing bad odors.
- ☞ If too much detergent is used or cold water is used, it doesn't dissolve completely and remain on the garments, hose or inner tub, causing contamination on clothes.
- ☞ In case of reserved washing, detergents must be put in the detergent box. If the powder detergents are spread on laundry directly, it may cause discoloration.

CARING FOR CLOTHES BEFORE WASHING

- ☞ Must follow the checkpoints in order to avoid machine problem or damages on garments.
- ☞ If the below problems are caused by customer's faults, separate service fee will be charged.

Take out personal belongings from pockets.

- ☞ **Caution.** Check the pockets! Hairpins and coins may cause damages to clothes and washing machine. They may make noise and problems to the machine. Must check the pocket.



CHECKING BEFORE WASHING AND CARE FOR GARMENTS

If pants zippers are open while washing, the inner tub may be damaged. The zipper should be closed and fixed with a string before washing.

- ☞ If blue jeans and working uniforms zippers or hooks are made of steel, they must be closed before washing.
- ☞ Wash winter jumpers, working uniforms, bed cover sheets, and blue jeans separately.
- ☞ Fold clothes well into the inner tub. Must remove the curtain hooks before washing.
- ☞ Turn inside out the button decorated and embroidered clothes before washing.
- ☞ Be careful those metal decorations because they may cause heavy damages while washing.
- ☞ The long stringed clothes may tangle with other clothes. Must fix the strings before washing.
- ☞ The metal strings from brassieres may stick out and damage other clothes or the inner tub. Must use the commercial laundry net for washing brassieres. (Use a laundry net of fine mesh.)

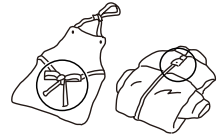

Waterproof clothes (Ski Wear, Diaper Covers, Footboards) are not allowed for washing.

- ☞ The waterproof sheet, clothes, and non water permeable fabrics shouldn't be washed, rinsed, or put in the inner tub. The laundry may pop out and cause severe vibration so that a person may get damaged and the machine, wall, and floor may break out in addition to clothes. (Examples are diaper cover, waterproof wear, raincoat, umbrella cover, ski wears, car sheet, and sleeping bags.)

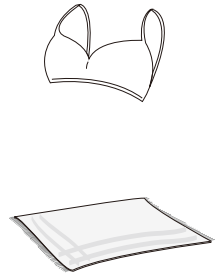

Cautions During Spinning

- ☞ Spinning of regular garments
 - The water from garments is drained out through the inner tub holes.
- ☞ Spinning of waterproof clothes and fabrics
 - Even if the inner tub spins, water can't drain out from the waterproof clothes and fabrics. Therefore, water gathers to one side and this causes a severe vibration. If the inner tub spins at a high speed, water still can't drain out from the waterproof clothes and fabrics. As a result, garments move up and pop out with a big vibration.

Shake the dirt or soils from clothes.

- ☞ Soil and sands may rub delicate garments to cause damages and the washing result may be unsatisfactory.



For protection of baby skin

- ☞ Wash diapers and baby wears (baby clothes, baby towels, etc) separately. Dirt may get to baby's clothes from adult's clothes if washing them together.

Do pre-washing for white socks, sleeves, and collars before the main washing

- ☞ Use powder and liquid detergents.
- ☞ Do not use soap. It may leave dirt to the inner tub.



CHECKING BEFORE WASHING AND CARE FOR GARMENTS

Turn inside out for those nappy clothes before washing.

- ☞ If clothes have too much foreign matter, separate them for washing. Other clothes may pick up those dirty matters (diet, thread).
- ☞ Wash black colored clothes and cotton towels separately. If they are washing together, towel may pick up dirty matters. Check before washing.

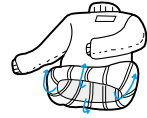

Cashmilon and those garments having big volume and lightweight(eg. lace-decorated clothes, ligerie, nylon stocking, synthetic fabrics etc.) may rise and cause damages to the clothes and problems to the machine. Use the laundry net or wash them separately.

- ☞ Must put those long stringed clothes, lace-decorated clothes, bed cover sheet, wool clothes into a laundry net before washing.
- ☞ Put delicate clothes in the laundry net.
- ☞ Use only those commercial laundry net for washing

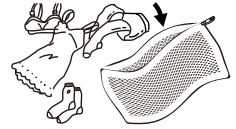

Curtains, floating garments or blue jeans shall be pressed not to float on the water

- ☞ If they are floated on the water, press Start/Pause button to stop and press them to sink in the water. If the washing goes on with clothes floating on the water, it may cause damages to the clothes and washing machine as well as unsatisfactory washing result.

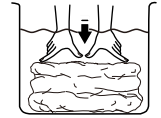

CONTROL PANEL

For more details, see the control panel of your washing machine

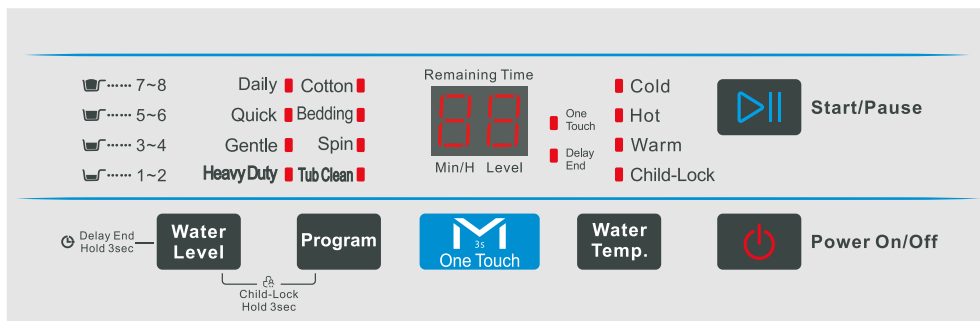

1. POWER BUTTON

Press this button once operate.
Press once again to turn the power off.



2. START/PAUSE BUTTON

It is used to pause and restart the operation.



3. WATER TEMPERATURE SELECT BUTTON

As you press this button, the type of water is selected as follow: COLD→HOT→WARM→COLD, select the needed one of the water temperature conditions (cold, warm, hot), correspond water temperature light will shine.



4. ONE TOUCH BUTTON

- When POWER Button is not pressed, continue press this button over 3 seconds, the washer run ONE TOUCH program, the ONE TOUCH light shines at the same time.
- Firstly press the POWER button, then continue press this button over 3 seconds, the washer start to run ONE TOUCH program, the ONE TOUCH light twinkles at the same time.
- Firstly press the POWER button, secondly press this button, select ONE TOUCH program, then press START/ PAUSE button, the washer start to run ONE TOUCH program, the ONE TOUCH light shines at the same time.



5. PROGRAM BUTTON

With every press of this button, the washing program changes.
Daily-Quick-Gentle-Heavy Duty-Cotton-Bedding-Spin-Tub Clean



6. WATER LEVEL SELECT BUTTON

• According to the wash-load, with every press of this button, select the water level, the correspond water level date shows in the digital tub:

1→2→3→4→5→6→7→8→□→1

• Continue press this button over 3 seconds, you can set the washer delay start time, with every press this button, set the delay start time.



CONTROL PANEL

For more details, see the control panel of your washing machine

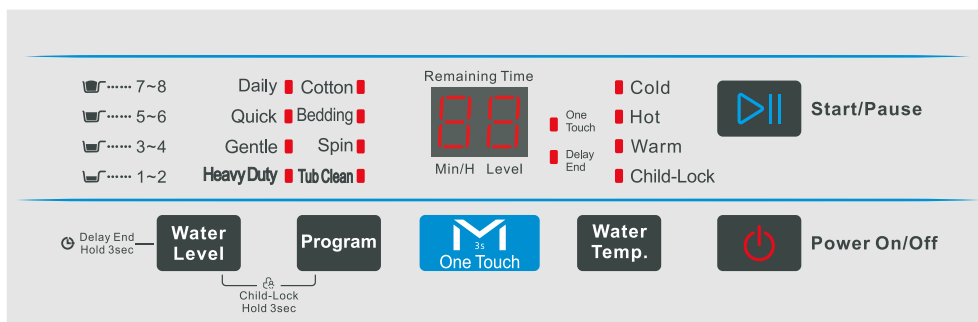

7. DIGITAL TUB

- When the washer starts to run, the digital tub shows the remaining time (in minutes) of each wash cycle.

For example: The residual time is 18 minutes, the digital tub shows: **18**

- When the washer has some faults, the digital tub shows the Failure Codes.

For example: Spinning does not work, the digital tub shows: **E1**

- When having set the washer delay start time, the digital tub shows the date of selecting delay start time.

For example: Delay start time is 4 hours. the digital tub shows: **4H.**

8. WATER TEMPERATURE AND FUNCTION INDICATOR LIGHT

- Shows three water temperature conditions. After pressing the WATER TEMP. button to select the water temperature condition, the corresponding light shines.
- Shows washer on CHILD-LOCK condition. After selecting CHILD-LOCK function, the CHILD-LOCK light shines.

9. PROGRAM INDICATOR LIGHT

After selecting the wash program, the corresponding program light shines.

HOW TO WASH AUTOMATICALLY DEPENDS ON THE LAUNDRY

➤ BEFORE STARTING WASHING, CHECK THE FOLLOWING:

- Connect the water supply hose to the water tap. Leave a tap open. Plug the power cord in. Make sure to set the drain hose well.

➤ WASHING FOR THE FIRST TIME

Before washing clothes for the first time, you must run a complete cycle without clothes. To do this:

1. Press the POWER button.
2. Pour a little detergent into detergent box or the inner tub.
3. Turn on the water supply faucet to the washing machine.
4. Press the PROGRAM button, select TUB CLEAN program.
5. Press the START/PAUSE button.

➤ PUT IN THE LAUNDRY

- The capacity of washing and spinning of the washer refers to the largest dry weight of the load that can be washed or spinning in one time. One time washing quantity shall be lower than the rated capacity.
- The thickness, size and type of the clothes will influence the actual capacity. It is suitable for one time washing to put in reasonable amount of laundries and the laundries can be turned round in washing



➤ HOW TO PUT THE DETERGENT IN

1. Open the detergent box by pulling in the direction of the arrow as shown in the figure and then put the powder detergent in the detergent box.
2. Put in one-time amount of detergent evenly so the detergent may not brim over the box.
3. If there is not detergent box in the washing machine, please pour the detergent into the inner tub directly.



➤ SPECIAL NOTES

Automatic Sensing Function

- At every program the amount of laundry is automatically sensed and then appropriate water level, washing time, rinsing cycle, and spinning time are automatically selected for automatic washing.
- After the power is on, a program is selected and START/PAUSE button is pressed. Then, the pulsator starts spinning without water, this action senses how much laundry is in the tub, not a machine problem. After this sensing process, water supplies automatically. Some programs do not have this function.

Adding detergent

- It senses the amount of laundry and indicates the water level. Then, it starts water supply right away.
- During the water supply, it is possible to open the detergent box and add detergent. However, it is better to press START/PAUSE button to stop water supply and add detergent. Close the lid and press START/PAUSE button again. This way is much more convenient.

Put the laundry into the washer and add detergent, too.

- Be careful not to overload. Use right detergent for the laundry you are washing.
- If the lid is open while running, the washing machine will be stopped automatically for safety. (Except, water supply continues while the lid is open.)
- Possible to control the water level at every program during the washing.

WASHING PROCEDURE

Before starting washing, check the following:

Connect the water supply hose to the water faucet. Leave the faucet open. Plug the power cord in. Make sure to set the drain hose well.

Put the laundry into the washing machine and add detergent, too.

Be careful not overload. Use right detergent for the laundry you are washing.

➤ ONE TOUCH PROGRAM

Selects the best washing program automatically.

1. Press the **POWER** button .



2. Press the **ONE TOUCH** button.

The **ONE TOUCH** program light shines.



3. Press the **START/PAUSE** button.

Water level is selected automatically. Washing, rinsing, and spinning follow. If you want to pause, press the **START/PAUSE** button again.



4. Close the lid.

EIGHT PROGRAMS



1. Press the **POWER** button .



2. Press the **PROGRAM** button in turn.

Select one of the eight programs (Daily, Quick, Gentle, HeavyDuty, Cotton, Bedding, Spin, Tub Clean), the corresponding program light shines.



Daily ■ Cotton ■
Quick ■ Bedding ■
Gentle ■ Spin ■
HeavyDuty ■ Tub Clean ■

3. Press the **START/PAUSE** button.

Water level is selected automatically. Washing, rinsing, and spinning follow. If you want to pause, press the **START/PAUSE** button again.



4. Close the lid.



DELAY START function

Select the **DELAY START** function when you have to go out or do something else.

1. Press the **POWER** button.



2. Press the **PROGRAM** button.

Select the needed program.



3. Continue to press the **WATER LEVEL** button over 3 seconds.

Go into the **DELAY START** selecting model, you may change the delay start time with press the **WATER LEVEL** button (from 0 hours to 24 hours), the delay start time shows in the digital tub.



4. Press the **START/PAUSE** button.



5. Close the lid

The washing cycle will start by the time you reserved.

WASHING PROCEDURE

- **CHILD-LOCK function:** *This is a devise to protect children from being accidentally hurt while playing with the washer*

How to start the Child-Lock function:

1. Press the **POWER** button 

2. Press **PROGRAM** button 
To select an initial washing program.

3. Press **START/PAUSE** button 
Start washing program.

4. Close the lid

If Child-Lock function is needed during the laundry.

5. Press both the “Water Level” and “Program” button at same time

Get the Child-Lock function start, the CHILD-LOCK function light shines.

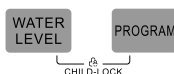

-  COLD
-  HOT
-  WARM
-  CHILD-LOCK

(Note: You can not perform the function without the “Power” button on.)

To release the function of Child-Lock:

- In case the “Child-Lock” is programmed, press both the “Water Level” and “Program” button at the same time to release the function of Child-Lock.

MANUAL FUNCTION

Each washing program can be changed manually. you can change two of the items (the water level and water temperature).

- **WATER LEVEL and WATER TEMPERATURE** function

1. Press the **POWER** button. 

2. Press the **PROGRAM** button. 
To select an initial washing program.

3. Select the water level or water temperature

3.1. Press **WATER LEVEL** button

Select the needed water level, correspond water level date (from 1 to 8 → □ → 1) shows in the digital tub.



3.2. Press the **WATER TEMP** button

Select the needed one of the water temperature conditions (cold, warm, hot), correspond water temperature light shines.



-  COLD
-  HOT
-  WARM
-  CHILD-LOCK

4. Press the **START/PAUSE** button. 

5. Close the lid

The washing program will run based on the functions you have selected.



MAINTENANCE

The User's Manual is for common use.

Make use of the User's Manual depending upon your washing machine model.

Proper care of your washer can extend its life. This section explains how to care for your washer properly and safely.

➤ CLEANING YOUR WASHER

Exterior	Interior
<p>Wipe up detergent, bleach, and other spills with a soft, damp cloth or sponge as they occur. Occasionally wipe the outside of your washer to keep it looking like new. During cleaning your washer.</p> <ul style="list-style-type: none"> • Do not flush it directly with water. • Wipe it with neutral detergent. • Do not wipe it with thinners, petrol, alcohol or other harsh solvents.  	<p>Clean interior with appropriate amount of detergent. Run washer through the "TUB CLEAN" program. Repeat process if necessary.</p>

➤ WINTER STORAGE OR MOVING CARE

Install and store your washer where it will not freeze. Because some of water may stay in the hoses, freeze may damage your washer.

If storing or moving your washer during freezing weather, winterize it.

To winterize washer	To use washer again
<ul style="list-style-type: none"> • Shut off water faucet. • Disconnect water inlet hoses. • Run washer on a DRAIN and SPIN program for 1 minute. • Unplug the power supply cord. 	<ul style="list-style-type: none"> • Flush water pipes and hoses. • Recombination water inlet hoses. • Turn on water faucet. • Recombination power supply cord.

➤ NON-USE OR VACATION

Operate your washer only when you are at home.

If you will be on vacation or not using your washer for an extended period of time, you should:

- Unplug the power supply cord or turn off electrical power to the washer.
- Turn off the water supply to the washer.

This helps avoid accidental flooding (due to a water pressure surge) while you are away.

➤ CLEAN THE LINT FILTER

Clean the lint filter often to keep your washer clean.

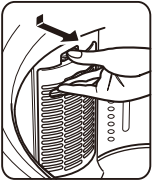
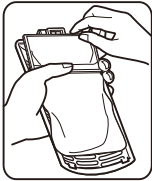
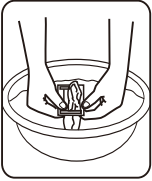
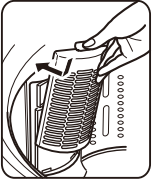
 <p>1. Push the upper part of the filter and pull off the filter.</p>	 <p>2. Put out the filter net from the filter.</p>	 <p>3. Clean the filter net.</p>	 <p>4. Insert the filter net into the filter, then insert the lower part of the filter in the basket first and then push the filter with "click" sound.</p>
---	---	---	--

MAINTENANCE

The User's Manual is for common use.

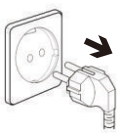
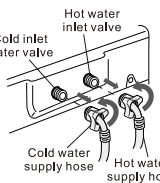
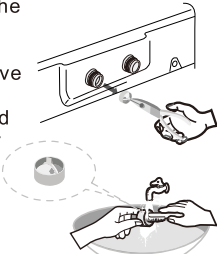
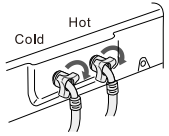

Make use of the User's Manual depending upon your washing machine model.

➤ CLEANING THE WATER INLET FILTER

<p>1. Pull the power cord plug out before cleaning it.</p> 	<p>2. Turn off the water supply to the washer and separate the inlet hoses.</p>  <p>Cold inlet water valve Hot water inlet valve Cold water supply hose Hot water supply hose</p>	<p>3. Pull out the filter, then using small brush remove the dirt on the filter and using water clean the filter well.</p> 	<p>4. Put the filter into the inlet valve and connect the water inlet hose to the water inlet valve tightly.</p>  <p>Cold Hot</p>
---	--	--	--

➤ CLEANING THE DRAIN FILTER

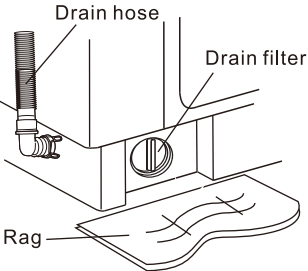
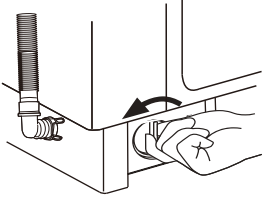
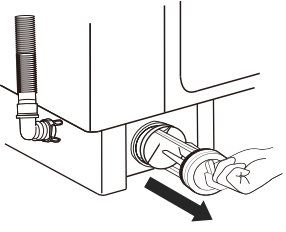
- In case "U" shape drain hose, this drain filter is equipped at the back side of washer.
- This drain filter is to screen the foreign stuffs such as threads, coins, pins, button, etc.
- If the drain filter is not cleaned at proper time (once a month). Drian problem could be caused.
- Do not clean the drain pump filter when there is water in the bucket; if there is a E3 alarm, it is necessary to put down the drain pipe to drain all the water first, and then clean the drain pump filter.

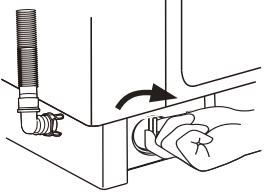
<p>1. Put down the drain hose, let the remained water flow out, and put a rag under the filter not to wet the floor.</p>  <p>Drain hose Drain filter Rag</p>	<p>2. Turn the filter cap anticlockwise.</p> 	<p>3. Pull out the filter assembly off the case of the drain pump.</p> 
<p>4. Removing the foreign stuffs. Clean the drain filter with water.</p> 	<p>5. Turn the filter cap clockwise tightly.</p> 	

ERROR CODES

➤ **Spinning does not work**

Is the laundry spread out evenly in the washer?

Is the washer installed on a sturdy and flat surface?

If the washer does not spin, a buzzer will sound, and the digital tub will show "E1".

E1



➤ **Water is not supply**

Is the water tap opened?

Is the water supply cut off?

Is the water supply hose or hose connection filter clogged?

Is the water supply hose frozen?

Is the pressure of water supply too lower?

Is the water inlet timeout?

If water is not supply, a buzzer will sound, and the digital tub will show "E2".

E2



➤ **Water does not drain**

Is the drain hose down? (No pump)

Is the drain hose frozen?

Is the drain hose clogged?

Is the height of the end of the drain hose over 15cm?(No pump)

If water does not drain, a buzzer will sound, and the digital tub will show "E3".

E3



➤ **Washing machine won't work**

Is the lid open?

If the lid is open, the washer won't work, a buzzer will sound, and the digital tub will show "E4".

E4



➤ **Washing machine won't work or does not drain**

Is the CHILD-LOCK function set and the lid open?

If the CHILD-LOCK function is set and the lid is open, the washer won't work or does not drain, a buzzer will sound, and the digital tub will show "EL".

EL



➤ **Other problem**

If the digital tub shows "EA" or "EC", Please press the POWER button, cut off power, pull off the power plug, call service agency immediately.

EA

EC

TROUBLESHOOTING

Most problems are easily solved if you understand the cause. Check the following list for problems before calling for service.

Before calling for service, check these

➤ **The power is cut off.**

Check1> Is the electric voltage normal?

Check2> Is the power plug of the washer plugged in receptacle?

➔ Insert the power plug into the receptacle.

TROUBLESHOOTING

➤ **The washing machine does not drain?**

- Check 1> Is the drain hose down? (No pump)
➔ Put the drain hose down.
- Check 2> Is the drain hose folded?
➔ Unfold the drain hose.
- Check 3> Is the drain hose outlet clogged?
➔ Remove the clogging matters cleanly.

➤ **The washing machine doesn't work**

- Check 1> Is the washer lid open?
➔ Close the lid.
- Check 2> Has the START/PAUSE button been pressed?
➔ Press the START/PAUSE button one more time and check if the washer starts.
- Check 3> Is enough water filled to the water level?
➔ If the water pressure is low, it takes a long time to start washing.
- Check 4> Is the faucet closed?
➔ Open the faucet to supply water.

➤ **The water leaks at the supply hose connector.**

- Check 1> If the faucet connecting part is loose, water may leak.
➔ Repeat the assembly steps again (Refer to "Connecting the water supply hose).
- Check 2> Check if the rubber packing of water supply hose is in right position.
➔ Screw tightly again.
- Check 3> Is the water supply hose folded?
➔ Unfold the hose.
- Check 4> If the water supply is too strong, water may leak.
➔ Close the faucet a little.
- Check 5> Is water leaking from faucet itself?
➔ Reassembly the faucet again, or replace the faucet.

➤ **Water is not supplied.**

- Check 1> Did you press the START/PAUSE button after selecting the water supply?
➔ If the START/PAUSE button is not pressed, water is not supplied. Press the START/PAUSE button.
- Check 2> Is the faucet closed?
➔ Turn on the faucet.
- Check 3> Is the filter net at the water supply hose connector clogged with dirty matters?
➔ Clean the filter net by brushing with a toothbrush.
- Check 4> Is the water supply cut off?
➔ If the water supply is suspended, turn off the faucet and power off.

➤ **Spinning makes loud noises and vibrations.**

- Check 1> Check if the laundry is spread evenly in the washer.
➔ Spread out the laundry evenly and start again.
- Check 2> Check if the washing machine levels on a sturdy flat floor.
➔ Set the washer at level.
- Check 3> Is around the washing machine filled unnecessary stuffs?
➔ Remove those unnecessary things away from the washing machine.

➤ **These cases are not malfunctions**

- The sound "wing" heard during water supply is the operating sound made by the water inlet valve.
- The sound "sha" heard in stopping step of the inner tub is the sound that comes from the liquid moving in the balance ring in the inner tub.
- the sound "hu-lo" heard during drain cycle is the sound of drain pump operating.

NOTE!

If the power supply cord is damaged, it must only be replaced by a repair shop appointed by manufacture, because special purpose tools are required.



Customer Service

1300 796 688

www.chiq.com.au