



Hood
User Manual

CTB6253 X







Please read this user manual first!

Dear Customer,

Thank you for preferring a Beko product. We hope that you get the best results from your product which has been manufactured with high quality and state-of-the-art technology. Therefore, please read this entire user manual and all other accompanying documents carefully before using the product and keep it as a reference for future use. If you handover the product to someone else, give the user manual as well. Follow all warnings and information in the user manual.

Explanation of symbols

Throughout this user manual the following symbols are used:

	Important information or useful hints about usage.
	Warning for hazardous situations with regard to life and property.
	Warning for electric shock.
	Warning for danger of fire.
	Warning for hot surfaces.



This product has been produced in environmentally friendly, modern facilities.

Complies with the WEEE Regulation.



Does not contain PCB.

Made in: P.R.C

1 Recommendations and Suggestions	4-5
1.1 General	4
1.2 Safety Precaution	4
1.3 Warning	5
2 Characteristics	6
2.1 Technical Specifications	6
3 Installation Instructions	7
4 Operation	10
5 Use and Maintenance	11
5.1 Carbon filter (not supplied)	12
6 Trouble shooting	13

1 Recommendations and Suggestions

1.1 General

- Carefully read the following important information regarding installation safety and maintenance. Keep this information booklet accessible for further consultations.
- The appliance has been designed as a exhausting version (external exhaust) or as a filter version (inter air recycle) cooker hood.

1.2 Safety Precaution

- Take care when the cooker hood is operating simultaneously with an open fireplace or burner that depend on the air from the environment and are supplied by other than electrical energy, as the cooker hood removes the air from the environment which a burner or fireplace need for combustion.
- Provide adequate ventilation in the environment for a safe operation for the cooker hood.
- Follow the local laws applicable for external air evacuation
- Appliance shall only be used with rated voltage and frequency.
- There is a fire risk if cleaning is not carried out in accordance with the instruction.
- There shall be adequate ventilation of the room when the range hood is used at the same time as appliances burning gas or other fuels. (Not applicable to appliances that only discharge the air back into the room).
- There is a risk of fire if cleaning is not carried out in accordance with the instructions.
- Caution: Accessible parts may become hot when used with a cooking appliance.
- The appliance is not intended for use by persons (including children) with reduced physical, sensory or mental capabilities, or lack of experience and knowledge, unless they have been given supervised or instruction concerning use of the appliance by a responsible person for their safety.
- Young children should be supervised to ensure that they do not play with the appliance.

1 Recommendations and Suggestions

- If the supply cord is damaged, it must be replaced by the manufacturer or its service agent or a similarly qualified person in order to avoid a hazard.

The instructions must include details concerning cleaning instructions and frequency of cleaning

1.3 Warning

In certain circumstances electrical appliances may be a danger hazard.

- Do not check the status of the filters while the cooker hood is operating.
- Do not touch the light bulbs after appliance use.
- Do not disconnect the appliance with wet hands and without to force the supply cord..
- Flame cooking is prohibited underneath cooker hood.
- Avoid free flame, as it is damaging for the filters and a fire hazard.
- Constantly check food frying to avoid that the overheated oil may become a fire hazard .
- Disconnect the electrical plug prior to any maintenance.
- Children don't recognize the risks of electrical appliance. Therefore use or keep the appliance only under supervision of adults and out of the reach from children.
- If the power cord is damaged, it must be replaced by the manufacturer or a qualified service engineer in order to avoid a hazard.
- Keep electrical appliances out of reach from Children or infirm persons. Do not let them use the appliances without supervision.
- Indoor use only.
- Do not dispose of electrical appliances as unsorted municipal waste, use separate collection facilities.
- Contact you local government for information regarding the collection systems available.
- If electrical appliances are disposed of in landfills or dumps, hazardous substances can leak into the groundwater and get into the food chain, damaging your health and well-being.
- When the appliance is not in use and before cleaning, unplug the appliance from the outlet.

2 Characteristics

2.1 Technical Specifications

	CTB 6253 X
Width	695 mm
Depth	265 mm
Height	400 mm
Supply voltage	220 - 240 V, 50 Hz
Control	2 positions
Suction power	440 m ³ /h / 260 m ³ /h (with CF)
Motor power	200 W
Lamp power	2 x 28W
Total power	256 W
Net weight	8,1 kg
Gross weight	9,63 kg

Markings on the product or the values stated in other documents supplied with the product are values obtained under laboratory conditions as per relevant standards. These values may vary according to the usage of the product and ambient conditions.

3 Installation Instructions

- The exhaust air must not be discharged into a flue which is used for exhausting fumes from other appliances burning gas or other fuels. (Not applicable for appliances which only discharge air back into the room)
- The minimum distance between the supporting surface for the cooking vessels on the hob and the lowest part of the range hood: When the range hood is located above a gas appliance, this distance shall be 65cm. If the instructions for installation for the gas hob specify a greater distance, this must be taken into account. (The distance of 65cm can be reduced for non combustible parts of range hoods and parts operating at safety extra low voltage provided these parts do not give access to live parts. Distance may be reduced to 60cm to align with the AGA code.)
- Regulations concerning the discharge of air have to be fulfilled
- Warning: Failure to install the screws or fixing device in accordance with the instructions may result in electrical hazards

The cooker hoods should be placed at a distance of 65-75cm from the cooking surface for best effect. (See Pic 1)

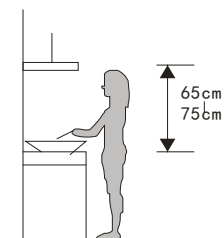

Pic 1

Way one: (See Pic 2A)

- To install onto the wall drill 4 holes of $\varnothing 8\text{mm}$ on a suitable place according with the centre distance of hole in the back of the cooker hood.
- Insert the wall plugs into the holes.
- Insert the screws into the wall plugs and tight the screws.
- Put up the cooker hood onto the fixed screws.
- Put the one air outlet and extensible pipe onto the cooker hood. (the extensible pipe is optional not supplied)

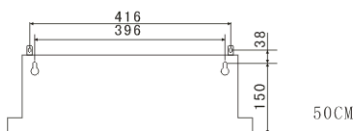

50CM

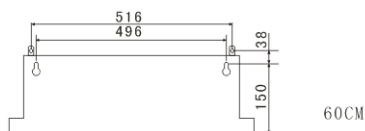

60CM

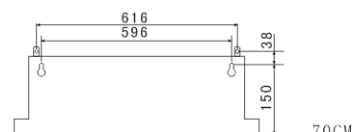

70CM

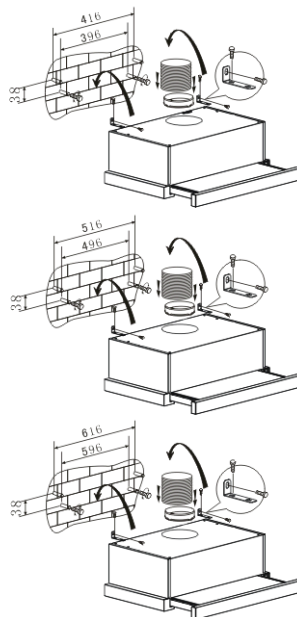

Pic 2A

3 Installation Instructions

Way two: (See Pic 2B)

- Drill 6 holes of 4mm diameter at the bottom of the hanging cupboard
- Put the air outlet on the cooker hood, then install the cooker hood on the bottom of the cupboard, tighten the hood with enclosed 6 screws.
- Install the adjusted board on the bottom of the hood in order to keep out the gap between hood back and cupboard.

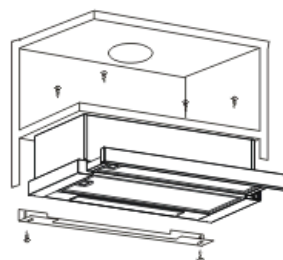
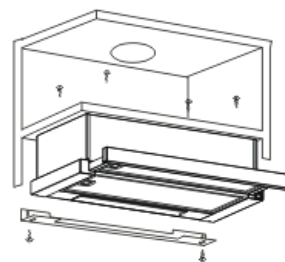
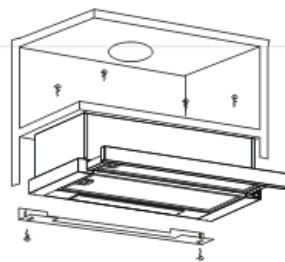
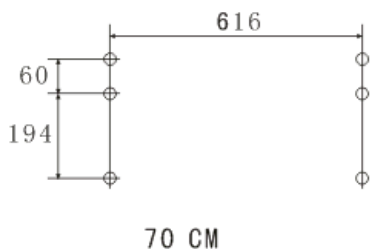
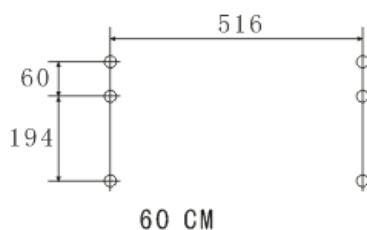
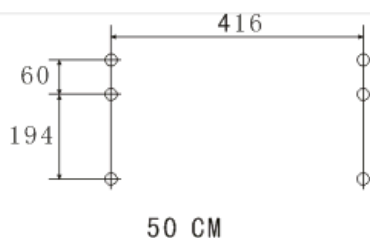

Pic 2B

3 Installation Instructions

7 Replacement for the front panel

Replace the front panel (80mm) is as below:

- Side the front panel of the cooker hood.
- In order to change front panel, the AI anti-grease filter should be detached firstly. Press the lock and pull it downward.
- Remove 4 screws in the back of the front panel (40mm)
- Put the front panel (80mm) on the slider board, adjust position in order to keep balance with the hood body, tighten with enclosed 4 screws.
- Repeat the same way if change to 40mm

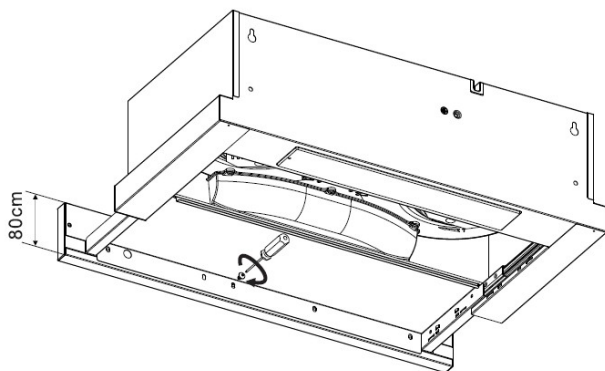
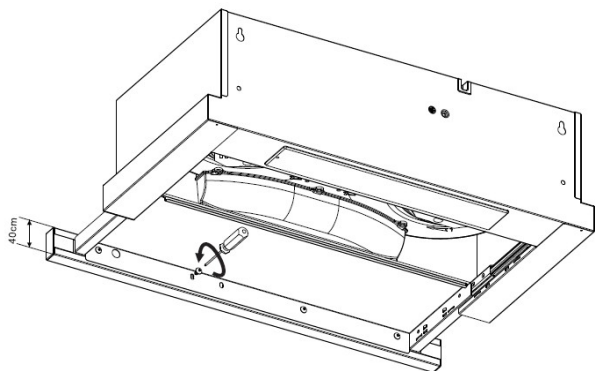

4 Operation

Connect the plug into the power.

Choose the ducting mode or the recirculation mode as you need (for Front- re-circulating models only):

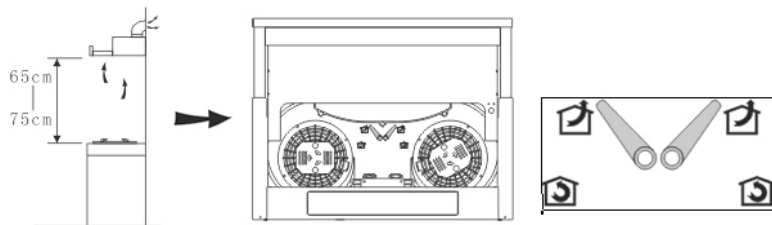

ducting mode

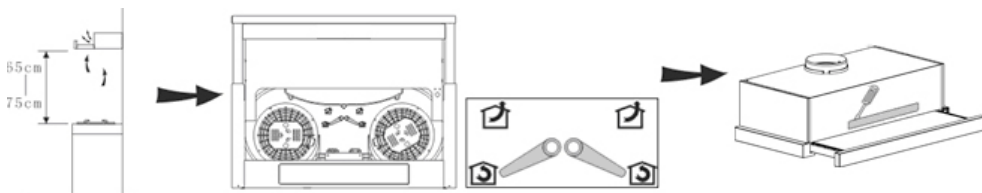

recirculation mode

Push the switch into “”, the lamp be on;
push into “0”, the lamp be off.

Push the switch into “I, II”, the motor will be on
“low, high” two speeds, push into “0”, the motor
will be off.

The cooker hood will working at low or high speed
when pull out the front panel.

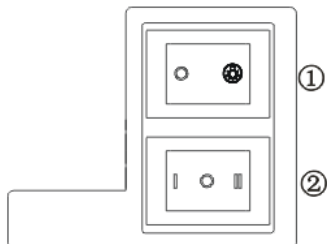

Pic 3

5 Use and Maintenance

- It is recommended to operate the appliance prior to cooking.
- There shall be adequate ventilation of the room when the cooker hood is used at the same time as appliances burning gas or other fuels(not applicable to appliances that only discharge the air back into the room).
- It is recommended to leave the appliance in operation for 15 minutes after cooking is terminated in order to completely eliminate cooking vapours and odours.
- If the appliance is not used, please turn off.
- Don't have flame under the cooker hood.
- Don't use or stop use if the appliance is damaged especially the supply cord and the case.
- If the supply cord is damaged, it must be replaced by the manufacturer, its service agent or similarly qualified persons in order to avoid a hazard.
- Don't immerse the appliance in liquid.
- The exhaust air must not be discharge into a flue which is used for exhausting fumes from appliance burning gas or other fuels.
- Regulations concerning the discharge of air have to be fulfilled.
- The details concerning the method and frequency of cleaning.
- In order to prevent fire hazard, it is recommended to clean the filter at a maximum of 2 months by carrying out the followings:
 - Unplug before cleaning, then remove the filters from the cooker hood and wash them in a solution of water and neutral liquid detergent, leaving to soak.
 - Rinse thoroughly with warm water and leave to dry.
 - The filters may also be washed in the dishwasher.

- The aluminum panels may alter in color after several washes. This is not cause for customer complaint nor replacement of panels.

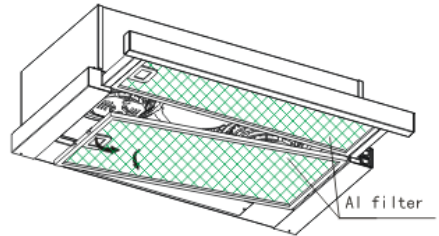

Pic 4

- Clean the surface of the cooker hood regularly using cloth moistened with denatured alcohol or non abrasive liquid detergent. (Remark: There can not clear the motor and inside part.)
- Replace filters approximately every 4 months.
- There is a fire risk if cleaning is not carried out in accordance with the instruction.
- Replace the lamp pls see pic 5.

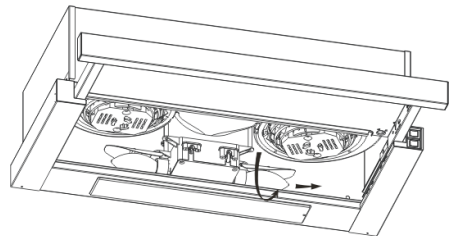

Pic 5

5 Use and Maintenance

5.1 Carbon filter

1. Put the charcoal filter foam on the back of the outer aluminium cassette filter.

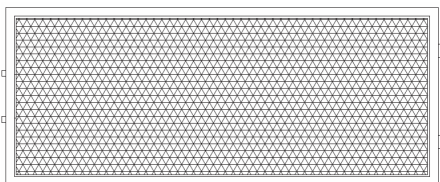

2. Use an iron wire to insert in the side of aluminium filter and press the charcoal filter foam.

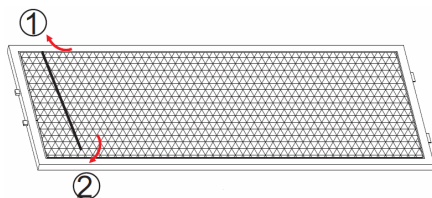

3. Use other three iron wires in the same method to press the charcoal filter foam flat.

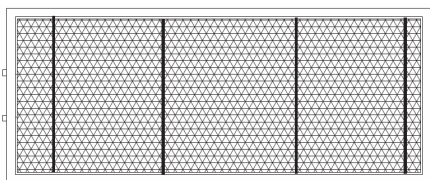

4. The same method is used to install the charcoal filter foam for inner aluminium filter, but it only uses three iron wires.

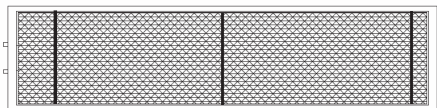

Note:
When the activated carbon filter installed, the suction power will be lowered.

6 Trouble shooting

Problem	Possible cause	Solution
The extractor fan ceases to function.	The kitchen hood feed cable is not connected to the network. There is no electrical current in the network.	Connect feed cable to the network. Check that the network has electrical current.
Insufficient suction power.	Did not set to the right speed and/or air outlet being blocked.	If the kitchen hood is set up for recirculation, check that the charcoal filter is still effective. If the kitchen hood is set up for extraction, check that the ducting and outlets are not blocked. The kitchen is adequately vented to allow the entry of fresh air.
Hood has switched off during operation.	The safety cut-out device has been tripped.	Turn off the hood and then wait for the device to reset. If the hood has been installed below the heights indicated in the installation instructions, the motor will cut-out frequently which may damage the hood.
The lamps do not light up.	The lamps are burnt out. The lamps are loose.	Change the lamps. Tighten the lamps.
Oil leakage.	One-way valve and air ventilation entrance not tightly sealed. Leakage from the connection of U-shaped section and cover.	Seal with glue on the one-way valve. Seal with soap or paint on U-shaped section.
Hood shakes during operation.	Leaf is damage. The body or motor tightly hung.	Replace the leaf as a damaged leaf causes shaking. Lock the motor tightly or fix the body tightly, respectively.



Beko Manufacturers Guarantee

Congratulations on purchasing a quality Beko product. Beko automatically provide you with a 2 year Manufacturers Guarantee, covering parts and labour for servicing within the geographical limits of Australia and New Zealand.

General Terms and Conditions

For Australian Consumers

This guarantee is an extra benefit and does not affect your legal rights. Our goods come with guarantees that cannot be excluded under the Australian Consumer Law. You are entitled to a replacement or refund for a major failure and for compensation for any other reasonably foreseeable loss or damage. You are also entitled to have the goods repaired or replaced if the goods fail to be of acceptable quality and the failure does not amount to a major failure.

For New Zealand Consumers

This guarantee is an extra benefit and does not affect your legal rights. Nothing in this guarantee purports to modify or exclude the conditions, guarantees and undertakings, and other legal rights, under the New Zealand Consumer Guarantees Act and other laws, except in those circumstances contemplated by section 43(2) of the New Zealand Consumer Guarantees Act.

Beko Guarantee

The Beko Manufacturers' Guarantee provides additional protection for your Beko Product, and it identifies a preferred approach to resolving product claims which will allow for a quick and simple process for all parties, subject to our terms and conditions below.

To enable us to assist you in the most expedient way please contact us by phoning the Toll free number (relative to your country of residence) as listed below. Please ensure you refer to your user manual and in particular the section headed "**Recommended Solutions for the problems**" before phoning.

The commencement date of this guarantee starts on the day of purchase and proof of purchase must be supplied to the Beko Service Centre prior to commencement of any guarantee work.

Terms and Conditions

Beko Australia and New Zealand Pty Ltd guarantees to the original purchaser to repair, or at its option replace, without charge to the owner for any part which is not of 'acceptable quality' within two years of date of purchase.

"No Lemon Guarantee" * if the product fails more than 2 times during the Guarantee period due to the same type failure caused by the same part, we will automatically replace the product with an equivalent product free of charge.

Food Spoilage*

If your product is a fridge or freezer, we will reimburse you for food which due to a valid fault as per our guarantee is spoilt; reimburse you as per the benefits below:

Up to 200 Litre	\$100.00
>200 Litre - 400 Litre	\$200.00
>400 Litre - 600 Litre	\$300.00
>600 litre	\$350.00

* Subject to a valid claim under the terms and conditions of this Guarantee

To be eligible for this Guarantee the product must be purchased from an Authorised Reseller in Australia or New Zealand.

What is not covered under this Guarantee

1. Any service calls in which the problem is found not to be caused or related to any defect in the Product. In this instance, the cost of the service call will be charged to you. Examples (but not limited too) of no product fault listed below:
 - a. Correcting the installation, e.g. levelling of product, adjustment of drain crossed or kinked hoses, leakage of hoses if incorrectly fitted, removal of transit bolts (front loading washers), noises due to water hammer and/or power supplies.
 - b. Replacing fuses or correcting house power wiring or house plumbing issues.
 - c. Failure due to incorrect set up or requiring instructions normally covered in user manual.
 - d. Blocked pumps, removal of foreign objects/substances from the washing machine, e.g. socks, bra wires, dirt etc.
 - e. Normal noise or vibration
 - f. Infestation of pests, insects or vermin

2. This Guarantee does not cover damage caused by:
 - a. Misuse or abuse of the Beko Product
 - b. Accidental damage of any kind
 - c. Rust and Corrosion where the product is located within a corrosive environment
 - d. Discolouration of burners or trivets on gas cooktops or chrome surrounds
 - e. Incorrect operation or not following the operation instructions as stated in the user manual.
 - f. Improper installation
 - g. Failure to clean or improper cleaning
 - h. Use of incorrect non – compliant electrical or gas connections
 - i. External sources including but not limited to electrical interference, power surges or voltage fluctuations.
 - j. Any loss caused by civil commotion
 - k. Any loss caused from extreme events of nature including but not limited to, flood, cyclone, severe storm and earthquake
 - l. Use of non genuine/authorised parts
 - m. Any repair or other work carried out on the Beko product other than by an Authorised Beko Service Personnel.

3. This Guarantee does not cover costs associated with replacing and servicing of consumable parts. E.g. lamps & bulbs, filters

This Guarantee has been designed for Products used in normal domestic environment. Our products are not designed for commercial use. Any commercial use may affect this Product's Guarantee.

Service under this Manufacturer's Guarantee is provided by the Beko Australia and New Zealand Authorised Repairer.

The Guarantee is provided by Beko Australia and New Zealand Pty Ltd (ABN: 49 152 055 162) of 55 Blanck Street, Ormeau, QLD Australia 4208, P O Box 354 Ormeau QLD Australia 4208.

In Australia if you need assistance.... Toll Free 1300 282 356

Email: Beko.care@Beko.com

In New Zealand if you need assistance.... Toll Free 0800 69 2356

Email: Beko.care@Beko.com

