

AKAI

HOME



8kg Digital Heat Pump Dryer with Wi-Fi Function

INSTRUCTION MANUAL

MODEL: AK-HPD8S



Contents

- 03 General Safety Instructions**
- 07 Unpacking**
- 08 Product Overview**
- 09 Installation**
- 12 Instructions**
- 22 Wi-Fi Control**
- 26 FAQs and Troubleshooting Guide**
- 28 Other Useful Information**

General Safety Instructions

IMPORTANT SAFETY INSTRUCTIONS READ CAREFULLY AND KEEP FOR FUTURE REFERENCE

Read this manual thoroughly before first use, the safety precautions enclosed herein reduce the risk of fire, electric shock and injury when correctly adhered to. Keep the manual in a safe place for future reference, along with any warranty information and your purchase receipt. If applicable, pass these instructions on to the next owner.

Always follow basic safety precautions and accident prevention measures when using an electrical appliance, including the following:

Electrical safety and cord handling

- **Voltage:** Make sure your outlet voltage and circuit frequency correspond to the voltage indicated on the appliance rating label and your outlet socket is properly earthed. If this is not the case, do not use the dryer.
- **Separate circuit:** We strongly recommend you connect the appliance to a separate circuit serving only this appliance. This provides the best performance and prevents overloading the house wiring circuits that could cause a fire hazard from overheating.
- **Electrical hazard:** Do not insert any objects into the appliance.
- **No extension cord:** Do not use this appliance with a power adaptor or extension cord. **CAUTION:** If such a device must be used, the cord or outlet device must be positioned so that it is not subject to splashing or ingress of moisture.
- **Protect the power cord.** Do not kink or damage the power cord. Position the cord out of the way so no one steps on or places anything on the cord or against it. Do not run the cord under floor coverings. Arrange the cord away from traffic areas where it will not become a trip hazard.
- **Protect from moisture:** Do not touch the plug with wet hands. Clean the plug only with a dry cloth.
- **Damage:** Do not operate the appliance after it malfunctions or has been dropped or damaged. In case of damage, contact our after sales support centre for advice.
- **Damaged cord:** If the power supply cord is damaged, do not attempt to change it yourself. A damaged cord or plug must be replaced by the manufacturer or a qualified person in order to avoid a hazard.
- **Gas leakage:** Do not connect/disconnect the power plug when there is a leakage of gas or other combustible gases.
- **Disconnect:** Unplug the clothes dryer from the power supply after use, before cleaning, servicing or moving the appliance. To disconnect, turn the appliance off, switch off the power outlet and remove the plug from the power outlet. Grip the plug when disconnecting; do not pull on the cord.
- **RCD:** Unless your home is already fitted with a residual current device (safety switch), we recommend installing an RCD with a rated residual operating current not exceeding 30mA to provide additional safety protection when using electrical appliances. See your electrician for professional advice.

General Safety Instructions (Cont.)

Usage conditions and restrictions

- **Domestic use only:** This appliance is intended for household use only. It is not suitable for commercial, industrial or trade use. Do not use it for anything other than its intended purpose (drying domestic quantities of washing), and only use it as described in this manual.
- **Indoor use only:** Do not use the appliance outdoors.
- **Usage restriction:** The appliance is not intended for use by persons (including children) with reduced physical, sensory or mental capabilities, or lack of experience and knowledge, unless they have been given supervision or instruction concerning use of the appliance by a person responsible for their safety.
- **Children:** Supervise children to ensure they do not play with the dryer. Close supervision is necessary when any appliance is used by or near children.
- **Do NOT install the appliance:**
 - near fire sources or heat sources such as radiators, heaters, air ducts or direct sunlight
 - in areas prone to damp or rainfall as water on the electrical components can damage the appliance and/or cause accidents
 - behind a lockable door, sliding door or door with a hinge on the opposite side to that of the clothes dryer, in such a way that a full opening of the clothes dryer door is restricted.
- **Positioning:** Place the clothes dryer in a clean, well ventilated area, away from water, frost and combustible materials. To keep vibration and noise to a minimum, place it on a flat, firm, dry and stable floor. Use the adjustable feet to assist in levelling, if required. Do not place it on any soft material such as foam or plastic.
- **Ventilation:** Do not block any ventilation openings. Ensure that ventilation openings in the base) are not covered by items such as papers, tablecloths, curtains, carpet.
- **Fire hazard:** Do not rest any burning candles or cigarettes on the appliance.
- **Before use:** Make sure to remove transport packaging at the rear of the dryer.
WARNING: Before loading the dryer, always ensure no pet or young child has climbed into it. Do not overload the clothes dryer. Ensure all pockets are empty.
- **Suitability for tumble drying:** Only load suitable items into the clothes dryer. See the box on the opposite page for which items and materials are unsuitable for the clothes dryer and may present a fire risk.
- **Preparation:** Make sure all pockets of clothing to be dried are empty. Hard, sharp objects such as coins, safety pins, bra wires, nails, screws, lighters or matches must be removed as they can cause extensive damage to the dryer.
WARNING: Any damage or malfunction resulting from foreign objects is not covered by your warranty and may lead to expensive repairs.
- **No open flames:** Do not place open flame sources such as candles on the dryer.

General Safety Instructions (Cont.)

- **Hot surface:** Parts of the appliance may be hot after a long drying cycle. Always ensure children are kept away from the machine. Do not store plastic, paper or clothing that may burn or melt on top of the dryer during operation.
- **Cool down:** The final part of a clothes dryer cycle occurs without heat (cooling phase) to ensure that the items are left at a temperature that will not damage them. **WARNING:** Never stop the clothes dryer before the end of the drying cycle unless all items are removed quickly and spread out so the heat is dissipated.
- **Subsequent cycles:** After turning off the power supply to the clothes dryer, wait at least two minutes before turning it back on again.
- **Cleaning:** Do not use water jets on the appliance when cleaning it.
- **Lint filter:** **WARNING!** The lint filter must be in place when drying. It must be cleaned before or after each use.
- **Service/repair:** This appliance contains no user-serviceable parts inside, except for cleaning the parts according to the instructions in this manual. Do not attempt to open, disassemble or repair it yourself; only have it serviced by qualified personnel, call our after sales support centre. The appliance should not be tilted or turned sideways during use or maintenance.
- **Do not attempt to modify** this product in any way. Doing so is dangerous and will void your warranty.
- **No timer:** This appliance must not be supplied through an external switching device such as a timer, or connected to a circuit that is regularly switched on and off by a utility.
- **Misuse:** Improper use or installation may result in the risk of fire, electric shock and/or injury. We accept no liability for any eventual injuries or damages caused by improper use or handling, or by any other noncompliance with the instructions.
- **WARNING!** This appliance contains refrigerant type R134a in a hermetically sealed system. Do not damage the refrigerant circuit. Do not vent gases into the atmosphere.

CAUTION!

- Do not use the heat pump dryer if industrial chemicals have been used for cleaning.
- Do not dry unwashed items in the heat pump dryer.
- Do not allow lint to accumulate around the dryer. Clean the filters after every use.
- Adequate ventilation has to be provided to avoid the backflow of gases into the room from appliances burning other fuels, including open fires.

CAUTION: Hot Surfaces!

- Parts of the appliance can become hot during use and retain heat for some time after turning off. Do not touch hot surfaces. Keep the power cord away from hot parts. Do not cover the appliance.

General Safety Instructions (Cont.)

CAUTION!

The items listed below are UNSUITABLE for clothes drying. They can cause fire in the dryer or extensive damage. DO NOT place them in the clothes dryer.

- ☒ Items containing **foam rubber** (also known as latex foam) or similarly textured rubber-like materials — when heated, these materials can spontaneously combust and cause a fire.
- ☒ Items that have been spotted or soaked with cooking oil, or with highly **flammable substances** — these substances constitute a fire hazard. Highly flammable substances used in domestic environments include acetone, alcohol, petrol, kerosene, some stain removers, dry-cleaning solvents, turpentine, waxes, wax removers and some hair care products. (This also includes items that have previously been cleaned or spotted with dry-cleaning solvents or other flammable or explosive substances.)
- ☒ Undergarments that contain **metal reinforcements** (such as underwire bras), which can come loose during drying and damage the clothes dryer.
- ☒ **Plastic articles** such as shower caps or waterproof baby bibs.
- ☒ **Rubber-backed articles**, clothes fitted with foam rubber pads, pillows, galoshes and rubber coated sports shoes.
- ☒ **Fabric softeners** or similar products, unless specifically recommended by the product manufacturer for use in a clothes dryer to eliminate the effects of static electricity.
- ☒ **Cushions, quilts** and the like, as these items accumulate heat.
- If it is unavoidable that fabrics that have been soiled with certain substances (vegetable or cooking oil, hair care products, acetone, alcohol, petrol, kerosene, spot removers, turpentine, waxes and wax removers) be placed in the heat pump dryer, they should first be washed in hot water with extra detergent — this will reduce, but not eliminate, the hazard. The 'cool down' cycle of a clothes dryer should be used to reduce the temperature of the items. They should not be removed from the clothes dryer or piled or stacked while hot.
- When using **stain remover** on your laundry, ensure you run an extra rinse cycle prior to loading the clothes dryer.



WARNING: Risk of fire

This symbol alerts you to take care as oil-affected items can ignite spontaneously, especially when exposed to heat, such as in a clothes dryer. The items become warm, causing an oxidation reaction in the oil. Oxidation creates heat. If the heat cannot escape, the items can become hot enough to catch fire. Piling, stacking or storing oil-affected items can prevent heat from escaping and so create a fire hazard.

Unpacking

CAUTION: VERY HEAVY!

- A team lift or mechanical aid is required when moving and installing this appliance.
 - Keep the heat pump dryer as upright as possible during transportation.
-
- This product has been packaged to protect it against transportation damage. Remove all packaging materials from inside and around the appliance.
 - Keep the original packaging carton and materials in a safe place. It will help prevent any damage if the product needs to be transported in the future, and you can use it to store the appliance when it is not in use. In the event that the carton is to be disposed of, please recycle all packaging materials where possible.
 - Plastic wrapping can be a suffocation hazard for babies and young children, so ensure all packaging materials are out of their reach and disposed of safely.
 - **CAUTION:** Before using the dryer, you must remove both pieces of packaging foam from the drum (Fig. 1):

Fig. 1: Remove the two pieces of packaging foam.

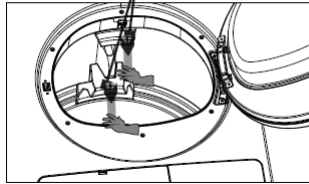

1. Open the loading door.
 2. Pull off the adhesive strips from inside the machine on top of the drum.
 3. Remove the two pieces of packaging foam from the machine.
- Check all parts of the package against the scope of delivery list on the following page and ensure you have received all items.
 - Inspect the cord and plug for damage or wear before each use. Do not use the appliance if the appliance or its cord is damaged or not working properly. In case of damage, contact our after sales support centre.
 - Read this manual to familiarise yourself with all the parts and operating principles of the heat pump dryer. Pay particular attention to the safety instructions on the previous pages.

Product Overview

Scope of delivery



Digital heat pump dryer

- 1 Water container
- 2 Control panel
- 3 Drum
- 4 Door
- 5 Lint filter
- 6 Maintenance cover
- 7 Levelling feet (one under each corner)

Other inclusions (not shown)

Water drain hose

Documentation (not shown)

Instruction manual
BEFORE YOU START leaflet
Warranty certificate

NOTE: Due to continued product improvement, images and illustrations in this manual may vary slightly from the product purchased. All images in this manual are for reference purposes only. Parts are not necessarily pictured to scale.

Installation

Important notes regarding installation

- Do NOT install the appliance:
 - ☒ behind a lockable door, sliding door or a door with a hinge on the opposite side of the dryer, in such a way that a full opening of the tumble dryer door is restricted
 - ☒ in a tight fitting cabinet, the appliance must not be built in
 - ☒ in an area where it will be exposed to temperatures below freezing. At temperatures around freezing point, the dryer may not be able to operate properly, and there is a risk of damage if the condensate water is allowed to freeze in the pump, hoses and/or water container
 - ☒ in an area where it will be exposed to water or weather, which could cause permanent damage
 - ☒ in an area where gas or flammable substances are used
 - ☒ near fire sources or heat sources, or where it is exposed to direct sunshine
 - ☒ directly on top of a washing machine.
- Ensure the dryer is unplugged from the power supply before installation. The plug must be accessible after installation.
- All electrical connections must be made by qualified personnel, and all instructions in this manual as well as local safety regulations must be observed.
- Exhaust air must not be discharged into a flue which is used for exhausting fumes from appliances burning gas or other fuels.
- Move cautiously when moving the dryer. Do not grasp any salient parts of the machine. Do not attempt to lift it by the door.
- After installation, check and ensure that the appliance is not sitting on or pressing against its electrical supply cord or drain hose.

Freestanding, floor level installation

- **The room:** Position the dryer on floor level, in a clean and dry, well ventilated area, away from heat and direct sunlight. Dirt must not be allowed to build up in the area, and air must be able to circulate freely all around the appliance. Do not obstruct any air inlets or ventilation openings.
- **The floor:** To keep vibration and noise to a minimum when the dryer is in use, make sure the floor surface is firm, flat, dry and stable. Do not place the appliance on soft material such as foam, plastic or carpet, as this could block the air intake. Do not restrict the floor clearance through deep pile carpets, strips of wood or similar. This might cause heat build-up, which could interfere with the operation of the appliance.
- **The area:** For your convenience, we recommend you position the dryer near your washing machine. Also ensure there is an appropriate electrical outlet nearby. Leave sufficient room at the back of the appliance for air dissipation.

Installation (Cont.)

Levelling the appliance

The appliance must be installed level, otherwise its operation will be impaired. When you have placed the dryer in its permanent position, press on the top frame (in both directions) to ensure the appliance is level: it should not shake or wobble. Alternatively, use a spirit level to ensure the appliance is level.

If your floor is slightly uneven, adjust one or more of the levelling feet to ensure level installation. The levelling feet are located underneath each corner

Turn the feet anticlockwise to lower the appliance, or clockwise to raise it (Fig. 2).

WARNING: Never remove the feet of the appliance, which would restrict the floor clearance required.

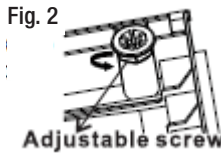

Drain hose installation

The heat pump dryer does not need to be vented, so you do not need to install an air duct. However, the appliance produces condensate water which is by default collected in the in-built water container and needs to be emptied after use.

Alternatively, you can drain the water into a nearby sink using an external drain hose (supplied). If you want to drain the condensate water directly into a sink, install the drain hose as follows:

Pull the water pipe in arrow direction from the hose connector at the back of the appliance, using pliers if necessary (Fig. 3). Install the external drain hose to the hose connector and lead the end into a standpipe or sink.

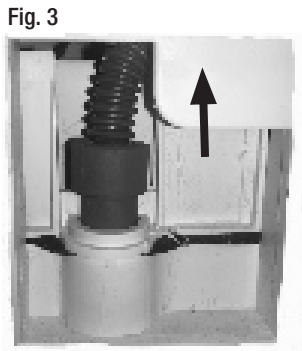

Installation (Cont.)

Earthing

WARNING: This is a Category I electrical product which must be earthed.

In the event of a malfunction or breakdown, earthing will reduce the risk of an electric shock by providing a path of least resistance for the electric current. This appliance is equipped with a cord having an equipment-earthing conductor and an earthing plug. The plug must be plugged into an appropriate outlet that is installed and earthed in accordance with all local requirements.

Ensure the outlet is properly earthed to the ground. If unsure, consult a qualified electrician or a service representative. Do not, under any circumstances, cut or remove the third grounding prong from the power plug. We accept no liability for damage to the appliance or personal injury resulting from failure to observe any electrical connection procedures.

Electrical connection

Before plugging in your new heat pump dryer, check and ensure the power supply system (current, power voltage and wire) at your home can meet the normal loading requirements of electrical appliances. The electrical voltage and circuit frequency are listed on the appliance rating label.

Do not kink or damage the power cord, and position it out of the way so no one steps on or places anything on the cord or against it.

Ensure the dryer is unplugged from the power supply before installation. The plug must be accessible after installation.

CAUTION: Do not use a power adaptor or extension cord.

Unless your home is already fitted with a residual current device (safety switch), we recommend installing an RCD with a rated residual operating current not exceeding 30mA to provide additional safety protection when using electrical appliances. See your electrician for professional advice.

All electrical connections must be made by qualified personnel, and all instructions in this manual as well as local safety regulations must be observed.

Once the heat pump dryer is properly installed, plug the electrical cord into an appropriately earthed three pin wall socket, switch on power at the socket and try the machine (see page 17 for trial usage instructions).

Instructions

Control panel buttons (Fig. 4)

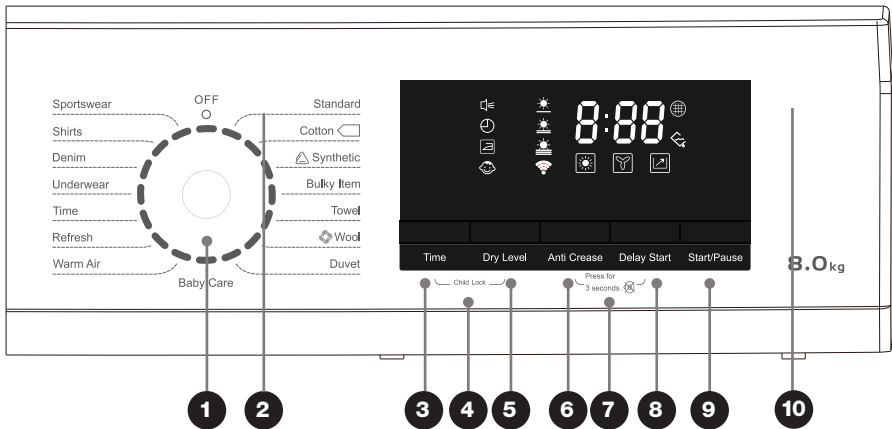

- 1 Program dial:** Turn the program dial (knob) clockwise or anticlockwise to switch on the appliance and select the required drying program (see page 16 for details of the programs).
- 2 OFF [O] position:** At the end of a program, turn the knob to the [O] position to switch the machine off.
- 3 Time button:** Press this button to extend the drying time. The “Time” program has a default drying time of 20 minutes, which can be extended in 10 minute steps.
- 4 Child lock:**
 - To activate the child lock after the drying cycle has started, press and hold the **Time** and **Dry Level** buttons for several seconds. When the child lock  icon lights up on the display, all buttons and knob operations are ineffective except for the off [O] position. (In an emergency you can still power the machine off.)
 - To cancel the child lock, press and hold the **Time** and **Dry Level** buttons for several seconds.
 - The function will be cancelled when you open the door or take out the filter drawer during operation, or when the water container is full and needs to be emptied.
- 5 Dry Level button:** If the program allows, use this button to select the drying level.
- 6 Anti-Crease button:** Use this button to extend the duration of the anti-crease phase.
- 7 Mute Buzzer:** Press and hold the **Anti-Crease** and **Delay Start** buttons for three to five seconds to mute the buzzer.
- 8 Delay Start:** Use this button to set the delay time (from 1 to 24 hours) of the start of a drying program.
- 9 Start/Pause button:** Press this button to start a drying program or to pause it.
- 10 Display screen:** Shows the settings, time remaining, options, codes, etc. (see page 13).

Instructions (Cont.)

Display icons and indicator lights (Fig. 5)



Table 1: Display icons	
	Shows the program duration and remaining time (in hours: minutes counted down), delay time (in hours counted down) and error codes.
	The buzzer light illuminates when the buzzer is set to on. If the symbol is crossed out, the buzzer is muted.
	The delay start light comes on when a delay start has been set.
	The anti-crease light indicates that the appliance is in the anti-crease phase.
	The child lock light indicates that the child lock has been set.
	The drying type lights indicate which drying level has been set.
	The Wi-Fi indicator It flashes rapidly when the unit is ready for configuration with your mobile device. It illuminates steadily when the Wi-Fi function is working.
	The drying light indicates the appliance is in the drying phase.
	The cooling light indicates the appliance is in the cooling phase. (A two minute cooling phase follows the drying phase.)
	The end of program light comes on after the cooling phase.
	The filter light comes on every cycle to remind you that the filter must be cleaned at the end of the program.
	The tank full light comes on after each program (and also when the water tank is full) to remind you to empty the water container. NOTE: Empty the water container after each use to avoid triggering an alarm during the next use.

Instructions (Cont.)

Before each drying

Checking the machine

Make sure you have read all safety precautions in this manual and are aware of the items (listed on page 6) that cause a hazard if placed in the clothes dryer.

The clothes dryer is intended only for drying textile material that has been washed in water and well spin-dried. Thoroughly spin the laundry in your washing machine on a high spin speed, which can reduce the drying time and save energy consumption.

Make sure the lint filters are clean and properly in place.

Can it be tumble dried?

Check and ensure that none of the items to be dried have the following symbols anywhere on them (Fig. 6), which indicate that items are **UNSUITABLE** for tumble drying.

Fig. 6: Unsuitable for clothes drying



Dry flat



Dry in the shade



Do not tumble dry



Hang to dry



Drip dry

Never tumble dry the following: particularly delicate items such as net curtains, woollen or silk fabrics, textiles with metal trim, nylon tights, bulky items such as anoraks, blankets, eiderdown or feather quilts, sleeping bags and any items containing rubber foam or similar materials.

Knitted textiles (knitted underwear) may shrink a little when tumble dried. Please do not over-dry such items. Allow for shrinkage when choosing the size of new purchases.

The following labels (Fig. 7) indicate that items are **SUITABLE** for tumble drying.

Fig. 7: May be tumble dried



May be tumble dried



Normal drying
(high temperature)



Delicate drying
(low temperature)

Instructions (Cont.)









Preparing the drying load

- The laundry must be thoroughly spun before tumble drying. Easy care items such as shirts, should be briefly pre-spun before drying.
- To avoid a static charge when drying is completed, use either a fabric softener when you are washing the laundry or a fabric conditioner specifically for tumble dryers.
- As the dryer heat may permanently set stains, check and ensure your washing is clean and free of stains.
- Sort the laundry according to fabric type and drying program. Separate dark and light coloured items as you would do when washing. Avoid drying dark clothes with light coloured, fluffy items such as towels as they could attract fluff.
- Ensure that the items to be dried do not have combustible materials or foreign objects (such as lighters, hair pins, coins) inside pockets.
- Turn items with zippers inside out, close zippers, press studs, hooks and eyelets, fasten buckles and tie fabric belts and apron strings. This will also help reduce impact noise when the items hit against the turning drum.
- Place small, delicate items in a mesh bag, but do not add too many to one bag. (It is not recommended to dry underwire bras in a clothes dryer.)
- Close pillowcases and quilt covers with fasteners to prevent small laundry items getting tangled inside them.
- To avoid items getting tangled up in the dryer, which results in uneven drying, shake items out thoroughly before placing them into the dryer one at a time.
- When closing the dryer door, ensure that items are not jammed in the door.

Maximum loads

- The recommended maximum drying loads are indicated in the programs table on the next page. As a general rule:
 - **cotton, linen:** drum full but not too tightly packed
 - **synthetics:** drum no more than half full
 - **delicate fabrics and woollens:** drum no more than quarter full.
- Try to load the maximum capacity of the machine as small loads are uneconomical.
- **CAUTION:** Do not overload the dryer: the maximum amount of dry textile material that can be dried in one load is 8kg (see Fig. 8 below for some reference weights).

Fig. 8: Reference weights

 Single bedsheet (about 600g cotton)	 Jeans (about 800g)	 Sleepwear (about 200g)	 Long sleeve shirt (about 300g cotton)
 Short sleeve shirt (about 180g cotton)	 Short pants (about 70g cotton)	 Socks (about 50g mixed-weave)	 Jacket (about 800g cotton)

Instructions (Cont.)

Table 2: Drying programs

Program	Max. load (kg)	Default time (hr:min)	Drying application / properties
Standard	8	4:50 (C)	Everyday clothing and other items made of mixed/ blended fabrics – different drying levels are available
Cotton  (A)	8	3:42 (C)	Cotton clothing and other cotton items – different drying levels are available
Synthetic	4	1:42 (C)	Clothing and other items made of synthetic fibres – different drying levels are available
Bulky Items	8	3:22 (C)	Larger, bulkier items (bedsheets, quilt covers, etc.) – different drying levels are available
Towels (B)	4	3:02 (C)	Towels – different drying levels are available
Wool	2	1:52	Woollen, knitted garments
Duvet	3	1:32	Down jackets, duvets and other down-filled items (with a maximum weight of 3kg)
Baby Care	3	1:32	Baby clothes
Warm Air	4	2:00	Delicate items made of silk or similar fibres – the machine selects the correct drying time depending on the load of delicate items
Refresh	4	0:50	A low-drying program to refresh items that have been kept in closed environments for a long time – the drying time depends on the load
Time	8	0:20	A manual drying program which allows you to set the drying time – recommended for drying thick or multi-layered textiles, individual items or small volumes. The default drying time is 20 minutes, which can be extended in 10 minute steps.
Underwear	2	1:02	Underwear
Denim	4	3:52	Denim jeans or leisure clothes that have been spun at high speed in the washing machine
Shirts	2	2:17	Shirts
Sportswear	2	1:47	Sportswear, thin fabrics or non-iron polyester items

NOTES

- (A) This program was used for energy efficiency testing to the standard. It is the most suitable program for drying a normal cotton load at the rated load capacity.
- (B) When drying particularly large towels or bulky bathrobes, do not exceed 6kg. If items are not completely dry at the end, add an extra drying time using the “Time” program.
- (C) Selecting a drying level will increase the default time by 5–17 minutes, depending on the level.

Instructions (Cont.)

Trial run

In order to remove any dust and grease, which may be in the drum from the manufacture and transportation processes, we recommend you run the dryer with some clean, damp rags before using it for the first time with your laundry.

Make sure the dryer is properly installed, plugged in and power is supplied.

Put some clean, damp rags into the drum.

Turn the **Program** dial to the “Time” program.

Press the **Time** button and set a 30 minute drying time.

Press the **Start/Pause** button and let the program run to the end.

Remove the rags and clean the lint filter (see page 29).

Child lock

The heat pump dryer is equipped with a child lock which locks the buttons to prevent unauthorised access to the controls while the machine is running.

To set the child lock, while the machine is on, press and hold the **Time** and **Dry Level** buttons for several seconds. When the child lock  icon lights up on the display, all buttons and knob operations are ineffective except for the off [O] position. (In an emergency you can still power the machine off.)

To cancel the child lock, press and hold the **Time** and **Dry Level** buttons for several seconds.

NOTE: The function will be cancelled when you open the door or take out the filter drawer during operation, or when the water container is full and needs to be emptied. You can set the child lock again when you restart the machine.

Automatically controlled drying

Choose one of the automatically controlled drying programs if you do not want to set a drying time. An in-built sensor monitors the moisture level in the items to be dried and adjusts the drying time accordingly for optimal results. Automatically controlled drying is NOT available in the “Warm Air”, “Refresh” and “Time” programs.

The program duration is calculated automatically on the basis of the maximum load accepted for each type of fabric and the required drying level. When the program starts, the remaining time (counted down in minutes) is shown on the display.

Time-controlled drying

Choose the “Time” program for drying less common loads, for example, when you require a longer drying time for thick or multilayered textiles or a shorter drying time for individual items or small volumes. The default drying time is 20 minutes, which you can increase in 10 minute steps by pressing the **Time** button.

Instructions (Cont.)

Program options

Depending on the program, you can select a number of options *after* you have selected the program and *before* pressing the Start/Pause button.

Buzzer

The buzzer can be set to ON or OFF; the default setting is ON. Use this function to mute the buzzer.

Press and hold the **Anti-Crease** and **Delay Start** buttons for three to five seconds to mute the buzzer and the corresponding light.

When the buzzer is muted, press and hold the **Anti-Crease** and **Delay Start** buttons to activate the buzzer and corresponding light. A sound will be emitted.

Dry level

For the “Standard”, “Cotton”, “Synthetic”, “Bulky Items” and “Towels” programs you can select one of three drying levels.

Before you start the machine, press the **Dry Level** button and set the drying level to “Heavy”, “Strong” or “Normal”.

NOTE: Selecting a drying level will increase the default drying time by 5 to 17 minutes, depending on the level set.

Anti-crease

The anti-crease function will help minimise creasing of your load. After the selected drying program has finished, the dryer will continue rotating the drum periodically for 10 minutes (default), or until the door is opened. A longer anti-crease time (max. 120 min.) can be selected while the program is in standby or running.

Press the **Anti-Crease** button to extend the anti-crease function for up to 120 minutes. You can remove your laundry during the anti-crease phase.

NOTE: The “Cotton” program has no automatic anti-crease phase, but you can set one using the **Anti-Crease** button.

Delay start

This button allows you to delay the start of the program by up to 24 hours. Each time you press the button, the time is increased by one hour (Fig. 9).



Press the **Delay Start** button after you have selected the required program and before pressing the **Start/Pause** button. The corresponding indicator light starts flashing and the countdown begins. All indicator lights extinguish except the “Delay Start” indicator light. The countdown time is displayed hour by hour.

If you want to check the selected program, press the **Delay Start** button again. The display will show the duration of the previously selected program.

Instructions (Cont.)

Step-by-step guide to using the dryer

(a) Loading

Open the door and load the dryer following the guidelines on page 15. The total weight of the load to be dried depends on the program chosen. All maximum load values are listed in Table 2 on page 16.

Close the door and ensure that no items are caught in the door.

(b) Selecting a program

Turn the **Program** dial to select the desired drying program. The **Start/Pause** light starts flashing. If you do not press any buttons within the next 10 minutes, the program selection will switch off.

(c) Selecting a program option

Depending on the program, you can add one of the speciality functions to customise your drying program.

To select a program option, press the relevant option button (**Dry Level, Anti-Crease, Delay Start**) *after* choosing the desired program and *before* depressing the **Start/Pause** button. The corresponding indicator light comes on; it will extinguish when you press the button again.

(d) Starting a program

Press the **Start/Pause** button to commence drying. The drum will start rotating.

(e) Pausing a program

To pause the drying process, press the **Start/Pause** button or open the door while the program is running. When the machine is suspended, the **Program** dial and buttons are invalid except for the **Start/Pause, Anti-Crease** and **Mute Buzzer** buttons.

To restart the program, press the **Start/Pause** button once again.

(f) Modifying a program

To change a program which is running, first cancel it by turning the **Program** dial to the OFF [O] position.

Then select the new program and then press the **Start/Pause** button.

(g) Cancelling a program

To cancel a program which is running, turn the **Program** dial to the OFF [O] position.

IMPORTANT: If the drying program has to be stopped before it reaches the end, we recommend you turn the **Program** dial to the “Refresh” position and wait until the end of the cooling phase before removing the laundry. This will avoid a build-up of heat inside the appliance. To do this, first turn the dial to the OFF [O] position, then to “Refresh” and then press the **Start/Pause** button.

Instructions (Cont.)

(h) At the end of the program

All drying programs end with a two minute cooling phase. If the laundry is not removed at the end of the cycle, the dryer runs an anti-crease phase (default: 10 minutes, adjustable up to 120 minutes), unless you open the door and remove the load.

If you do not remove the laundry, the dryer will stop automatically at the end of the anti-crease phase. The display shows “End” and the buzzer sounds for 15 seconds (when the buzzer function is on). (If there is no activity within 10 minutes, the appliance will enter a dormant state.)

Turn the **Program** dial to the OFF [O] position to switch the machine off before removing the laundry.

If individual items are still damp after drying, set a brief post-drying time. Please note that at least 30 minutes post-drying time will be required to dry the items completely, especially for multilayered parts such as collars, pockets, etc. Do not over-dry laundry, this avoids creasing and saves energy.

Unplug the dryer from the power supply.

After every use, clean the filter and empty the water container (see pages 29–30 for instructions).

Door opening

While you can open the door during operation to add an item you forgot, we recommend you do NOT open the door until the program has finished to avoid getting scalded, as parts of the machine may get hot during operation. If the door is opened during operation, the dryer will automatically stop. To restart it, you must close the door securely and press the **Start/Pause** button.

CAUTION!

- To avoid scalding and creating a fire risk, do not stop the clothes dryer before the end of the drying cycle, as parts of the appliance may get hot during use.
- If you must remove items during the drying cycle, open the door, remove them quickly, and spread them out so that the heat is dissipated.
- Do not use any combustible substances (for example, spray cans) close to the dryer while it is in operation. If gas has escaped from the can, do not touch the plug or start/pause the appliance.

Instructions (Cont.)

Energy saving tips

Compared with a traditional, vented type of dryer, this heat pump dryer is significantly more energy efficient, boasting a 7 star energy efficiency rating. To further reduce your energy consumption and help protect the environment, we recommend that you follow these hints:

- Try to load the maximum capacity of the machine as small loads are uneconomical.
- When using the “Time” program and determining the drying time yourself, do not over-dry laundry, this avoids creasing and saves energy.
- Select the drying program according to the type of laundry and the required degree of dryness.
- Clean the filters regularly to avoid excessive drying times and high electricity consumption.
- Ventilate the room well.

DRYING TIME

Drying a load takes longer in a heat pump dryer than in a vented dryer.

Table 2 on page 16 gives the default drying times for each program.

Bear in mind that these drying times are indicative only; higher drying levels will increase the actual drying time. But the machine’s in-built moisture sensor ensures that your washing won’t get dried for longer than necessary, so no energy is wasted.

Wi-Fi Control

This **AKAI Home** 8kg Digital Heat Pump Dryer features Wi-Fi technology, which enables you to control the appliance remotely from wherever you are—at work, at play or on the go—so that on your arrival at home your clothes are fully dried, ready for folding.

How it works

Before you leave your home, get your drying load ready, load it in the machine and close the door. You can then control the machine from anywhere using your mobile phone: set the required drying program and program option (e.g., anti-crease or drying level), set or cancel the child lock, start the machine and check the progress: the time remaining will be displayed.

The dryer works in conjunction with your mobile device, using your home Wi-Fi network router to communicate with the machine.

Controlling the dryer remotely is very easy. You will need:

- an Android smartphone or tablet, or an Apple iPhone or iPad
- an internet connection at your home
- a Wi-Fi network router set up at home.

You must also have our **AKAI Home** app installed or updated on your smartphone or mobile device. This app is available from Google Play Store or Apple App Store.

Initial set-up

Upon installation of your new dryer, or when you have changed your mobile device or wireless router, you will have to set up the communication channel between the devices. In order to do this, make sure you have the **AKAI Home** app installed or updated on your mobile device, your Wi-Fi router is switched on and your mobile device connected to your home Wi-Fi network.

On your mobile device, tap on the **AKAI Home** app. It will open and take you to the log in page. Before you log in, please follow the prompts to register your account (using your email account) and set a password.

IMPORTANT!

Before you can control your dryer remotely, you must activate (reset) the Wi-Fi module:

- Turn the program dial to turn on the machine.
- Press and hold the **Delay** and **Anti-Crease** buttons at the same time until the unit emits a beeping sound. On the LED display, the Wi-Fi icon will start flashing rapidly, indicating that the appliance is ready for configuration with your mobile device.
- Follow the app prompts until the Wi-Fi icon illuminates steadily (Fig. WIF1).

Fig. WIF1

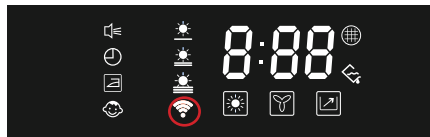

Wi-Fi Control (Cont.)

On the main device list page you can add the dryer from the product list. You may have to confirm your Wi-Fi name and password, then follow the prompts to add the appliance.

While the dryer is being added, the progress will be displayed.

On completion, when your device has been successfully added, follow the prompts to name the device.

You can then enter the device's main control page.

Alternative pairing mode

If the device is not responding you will get a message with a few prompts to check the Wi-Fi details.

If you want to switch the pairing mode, follow the prompts.

After you have confirmed your Wi-Fi network and password, connect your mobile phone to the device's hotspot, then go back to the app and continue to add the device.

Device sharing

The device only recognises ONE registered user. But you can share access to the device with other members of your household if they have the **AKAI Home** app installed and updated on their phone. To share the device, proceed as follows:

On the device's main control page, click the edit symbol in the corner, then select to share the device and follow the prompts.

Using the AKAI Home app

Operating the dryer with the **AKAI Home** app is self-explanatory. You can select the drying program, anti-crease and drying level, start the machine, check the program progress, and set/cancel the child lock. The app will display the remaining time and sound an alarm when the program has finished.

Wi-Fi Control (Cont.)

Adding the AKAI Home app to your Google Home app *

- Open your Google Home app.
(Before you can link your **AKAI Home** app to your Google Home app you will have to have a Google Home account set up.)
- From the home screen of the Google Home app, tap [**Add**].
- Tap [**Set up device**], then tap [**Have something already set up?**] under the “Works with Google” banner.
- Using the magnifying glass icon, search for **AKAI**.
- Tap the **AKAI Home** app and enter your **AKAI Home** account details and password, then tap [**Sign in**].

Adding the AKAI Home app to your Alexa account *

- Before you can link your **AKAI Home** app to your Alexa account you will have to have an Alexa account set up.
- From the home screen of the Alexa app, tap the three bars in the top left hand corner. Tap [**Skills & Games**], then use the magnifying glass icon to search for **AKAI**.
- Select the **AKAI Home** app. Ensure you have followed the steps listed, then select [**Confirmed**] and tap [**Next**]. Enter your **AKAI Home** account details and password, then tap [**Sign in**].

* These instructions for adding the **AKAI Home** app are of a general nature only. Detailed steps or specific messages from your Google Home or Alexa account may vary depending on the version.

Smartphone and Wi-Fi specification requirements

Minimum smartphone specifications

Android 5.0 version or later, IOS 10.0 version or later

Wireless network requirements of the Wi-Fi module

Frequency band	FCC/IC: 2.412 to 2.462 GHz, CE: 2.412 to 2.472 GHz
Wi-Fi standard	IEEE 802.11 b/g/n 2412 to 2472: correspond to channels 1 to 13 2412 to 2462: correspond to channels 1 to 11
Data transmission rate	802.11b: 1, 2, 5.5 or 11 (Mbps) 802.11g: 6, 9, 12, 18, 24, 36, 48 or 54 (Mbps) 802.11n: HT20 MCS0 to MCS7
Antenna type	PCB antenna

Wi-Fi Control (Cont.)

Wi-Fi troubleshooting

Problem	Possible cause and solution
<p>During the set-up, the dryer cannot be configured successfully.</p>	<p>Check and ensure you have internet reception and your mobile phone and the dryer are connected to the same Wi-Fi network.</p>
	<p>Check and ensure your Wi-Fi password is correct.</p>
	<p>Check and ensure that no firewalls or other restrictions are set.</p>
	<p>Check and ensure that the router works normally — check the network requirements.</p>
	<p>Ensure that the dryer, router and mobile are all on the same Wi-Fi network and within the signal range.</p>
<p>I cannot control the dryer with my mobile.</p>	<p>If a message is displayed to alert you to an identification failure, the dryer has been reset and the mobile phone lost control permission. You need to reconnect the phone to the dryer, following the set-up instructions in this manual.</p> <p>If after these steps you still cannot control the dryer with your mobile, please delete the appliance from your device list and reconnect again.</p>
<p>My mobile phone cannot find the dryer.</p>	<p>If a message is displayed to alert you that the device is offline, please check and ensure that your dryer is connected to your mains supply and power is switched on at the outlet.</p> <p>Also ensure that your router is connected to the mains supply and that the router and your mobile phone are properly connected to your Wi-Fi network.</p>

FAQs and Troubleshooting Guide

Troubleshooting guide

If your heat pump dryer has a fault, is not working properly, or you think it should work better, please use the list below to identify and solve any problems.

If you cannot solve the problem, switch off the dryer and unplug it from the power supply. Then contact our after sales support centre for advice. Do not attempt to dismantle or repair the dryer yourself.



Problem	Possible cause	Solution
The dryer does not start, or the display is not on.	Is the power plug inserted firmly? Is the door closed? Is the power switched on at the wall socket? Have you selected a program and pressed the Start/Pause button?	Insert the power plug firmly. Close the door securely. Switch on power at the wall socket. Select a program and press the Start/Pause button.
Clothes shrink.	Are the clothes are unsuitable for drying in the clothes dryer? Have the clothes been dried at too high heat?	Check the clothes labels and hang dry, if recommended. If the clothes may be tumble dried, choose a drying program more suitable for the fabric.
The washing is not thoroughly dried.	Are the filters clogged? Is the water container full? Is the drain hose blocked? Was an inappropriate program chosen? Did you load too much washing? Has the washing been twisted while drying?	Check and clean the lint filters. Empty the water container. Check and remove obstructions. Choose a program with a higher drying intensity. Reduce the amount of washing. Untwist the items and dry them for a little longer.
Drying takes unusually long.	Keep in mind that it is normal if you can still feel a little moisture in your washing at the end of a program (depending on the heat level selected). Any residual moisture is insignificant and will dissipate as soon as you shake the items out.	
	Please note that a heat pump dryer generally takes longer to dry a load. Table 2 on page 16 lists the default drying times for each program; higher drying levels will increase the actual drying time. But the in-built moisture sensor ensures that the washing does not get dried for longer than necessary, so no energy is wasted.	The drying load is too large.

FAQs and Troubleshooting Guide (Cont.)

Table 3: Troubleshooting guide		
Problem	Possible cause	Solution
There are some strange noises.	Heavy, wet clothes tumbling in the drum can cause bumping noises when the drum is turning.	These noises are normal. Make sure your drying load is properly spin dried to limit the noises.
The interior light doesn't come on.	The light bulb is defective.	Call for a service to get the light bulb replaced.
The drying program ends shortly after the start.	The load was too small. The washing load was too dry for the selected program.	Increase the drying load. Select a higher drying level, e.g., Heavy instead of Strong.

Warning indicators and error codes

The heat pump dryer will illuminate the following warning indicators or display the following error codes when it needs maintenance. If your corrective actions do not resolve the issue, please contact our after sales support centre and book a service.

Table 4: Warning indicators and error codes	
	The tank full light comes on after each program (and also when the water tank is full) to remind you to empty the water container. We recommend you empty the water container after each use to avoid triggering an alarm during the next use. If the light remains on, please call for a service.
	The filter light comes on every cycle to remind you that the filter must be cleaned at the end of the program.
[ErS]	The [ErS] message is displayed: – if you try to select an option that is not compatible with the selected program – if you select another program because of incorrect operation while the program is running.
[dop]	The door is open, or the filter is not installed properly. Check the filter installation and ensure the door is closed properly.

Other Useful Information

Cleaning and maintenance

Keeping your heat pump dryer in good, clean condition will prolong its service life.

WARNING!

- Before cleaning or maintaining any part of the dryer, make sure it has cooled down and is unplugged from the power supply.
- Never spray water directly onto the dryer to clean it.
- Never use benzene, thinner, alcohol or acetone to clean any part of the dryer. Doing so may cause discoloration, deformation, damage, electric shock or fire.

Cleaning the control panel

Use a dry, lint-free cloth to remove any moisture that may have accumulated on the control panel or door during the drying cycle. Use a soft, damp cloth for general cleaning. Do not use abrasive substances. Do not spray cleaners directly on the panel. The control panel finish may be damaged by some laundry pretreatment and stain remover products. Always apply such products away from your dryer and wipe up any spills or overspray immediately.

Cleaning the stainless steel drum

Do not use any type of spray cleaner when cleaning the drum. Use a damp cloth only, making sure it is not too wet. If the dryer drum has become stained, clean it with a damp cloth and a mild, non-abrasive cleaner suitable for stainless steel surfaces. Make sure to remove any cleaner residues thoroughly. Dry the drum with a clean cloth. Leave the appliance door open after cleaning to ensure the drum can air dry completely.

Cleaning the door and exterior dryer surfaces

Clean the interior parts of the door periodically to remove any fluff. Accurate cleaning ensures correct drying. The dryer's exterior surfaces have a high-gloss finish. Clean the surfaces with a soft dry or damp cloth. Do not use abrasive substances. Protect the surfaces from sharp objects as they may scratch or damage the finish. Do not place any heavy or sharp objects or a detergent box on the dryer.

Cleaning the humidity sensor

The humidity sensor is an essential part in the automatic drying process. It is located in the door rim, as pictured (Fig. 10). In order to maintain its effectiveness, the sensor must be kept clean and any calcium residues removed which may have accumulated on the surface. Remove any calcium and other water residues from the humidity sensor, if necessary using a nylon scouring pad or similar. Then use a soft cloth to wipe it clean.

Fig. 10

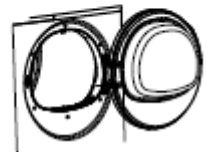
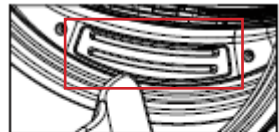

Other Useful Information (Cont.)

Cleaning the lint filter

To remove the filter, open the door to the clothes dryer, grip the lint filter and pull it straight up and out of the drum (Fig. 11).

Remove any lint, fibres and textile threads from the filter by hand or with a soft piece of cloth.

Close the lint filter and place it back into its housing.

A layer can build up on the filter pores that can cause clogging of the filter after using the dryer for a while. Wash the lint filter with warm water to remove the layer that builds up on the lint filter surface. Dry the lint filter completely before reinstalling it.

The lint trap has to be cleaned frequently.

Fig. 11

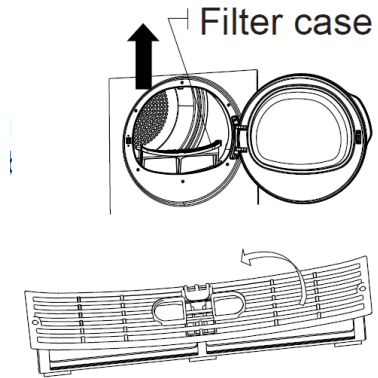

WARNING!

- Do not use the appliance without the filter. The lint filter must be in place when drying.
- Clean the lint filter and the inner surfaces of the loading door after each drying process.

Cleaning the evaporator

The evaporator is located behind the filter drawer. We recommend you clean it at least twice per month. Clean any dust and lint accumulated on the evaporator fins with a vacuum cleaner or a soft brush. You can also clean the fins by hand, provided that you wear protective gloves.

WARNING: Never attempt to clean the evaporator with bare hands (Fig. 12). The fins can injure your hand.

Fig. 12



Other Useful Information (Cont.)

Emptying the water container

The water container collects all the water from the condenser (unless you have the drain hose connected). The water container needs to be emptied after every drying cycle, the tank full  indicator will remind you to do so. This indicator will also illuminate if the water container is full while the dryer is in operation. Should that happen, the program will stop and a buzzer will sound. In order to continue the program, you must empty the water container first.

Holding the water container with two hands, pull it out of the dryer housing, tilt it over a sink and pour out the condensate water (Fig. 13).

Fig. 13

Water-tank

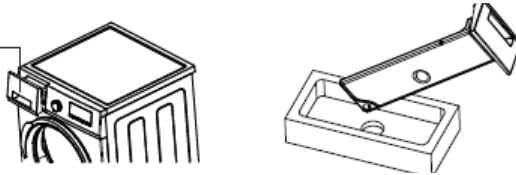

Insert the empty water container back into its space in the dryer housing.

To restart the program, press the **Start/Pause** button.

WARNING: Do not drink the condensate water. Do not use the dryer without the water container.

Cleaning the filter drawer

Lint and fibres that could not be captured by the lint filter are blocked in the filter drawer, which should be cleaned after each drying process. It is located behind the maintenance cover and contains a two-level filter: a filter drawer sponge and a filter cloth.

Place an absorbent cloth under the maintenance cover to catch any residual water.

Push down the locking latch to the maintenance cover. Unlock the fixer. Pull out the filter drawer (Fig. 14).

Fig. 14

Remove any lint, fibres and textile threads from the filter cloth by hand or with a soft brush or cloth (Fig. 15).

When you notice a layer that may lead to clogging of the filter cloth, clean off the layer by washing the filter in warm water. Let the filter cloth dry thoroughly before installing it back in the filter drawer.

Wash the filter drawer sponge by hand to remove any fibres and lint from the surface. After washing the sponge, squeeze it by hand and remove the excess water. Thoroughly dry the sponge before reinstalling it.

Fig. 15

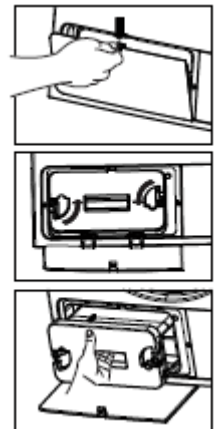
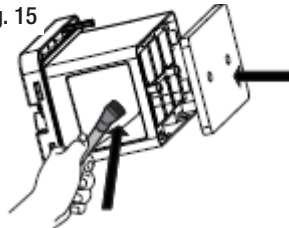

Other Useful Information (Cont.)

Storage

If you are not going to use the appliance for an extended period of time, unplug it and store it upright in the original packaging to protect it from dust. Store the unit in a dry place, out of children's reach.

Service, repair and spare parts

If the appliance is damaged, do not attempt to repair it yourself. If it requires repair or service, please contact our after sales support centre to arrange for examination and repair. Our after sales support centre stocks spare filters and legs for the appliance. To purchase a spare part, contact the centre using the details at the bottom of the page.

Technical specifications

Rated capacity	8kg
Rated Power, Voltage & Frequency	650W, 220-240V~, 50Hz
Ambient temperature range	+5°C to +35°C
Dimensions and net weight	595 (W) x 630 (D) x 850 (H) mm, approx. 46kg
Refrigerant	R134a (310g)

Compliance

This product has been fully tested and meets all requirements as set out by standards AS/NZS 60335.1 and AS/NZS 60335.2.11.



The RCM Mark (Regulatory Compliance Mark) indicates that the product complies with the relevant guidelines of the ACMA as well as corresponding government requirements for the safety of electrical devices.

Responsible disposal

At the end of its working life, do not throw this appliance out with your household waste. Electrical and electronic products contain substances that can have a detrimental effect on the environment and human health if disposed of inappropriately. Observe any local regulations regarding the disposal of electrical consumer goods and dispose of it appropriately for recycling and recovery of the refrigerant. Contact your authorities for advice on local recycling facilities.

Warranty returns

Should you for any reason need to return this product for a warranty claim, make sure to include all accessories with the product.

Product does not work?

If you encounter problems with this product, or if it fails to perform to your expectations, make sure to contact our After Sales Support Centre on 1300 886 649 for advice.