

TOURING ITEMS
TYPES
TERRA PRO™
4" FLOOD LIGHT

WP ITM. LM58280

Care & Use Instructions

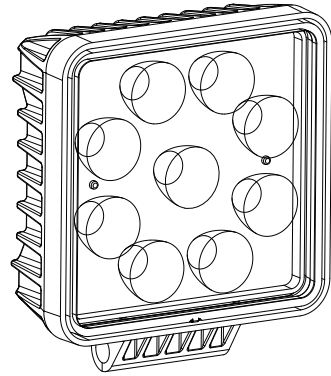

Important, retain for future reference:
Read carefully

RECOMMENDED MOUNTING POSITIONS

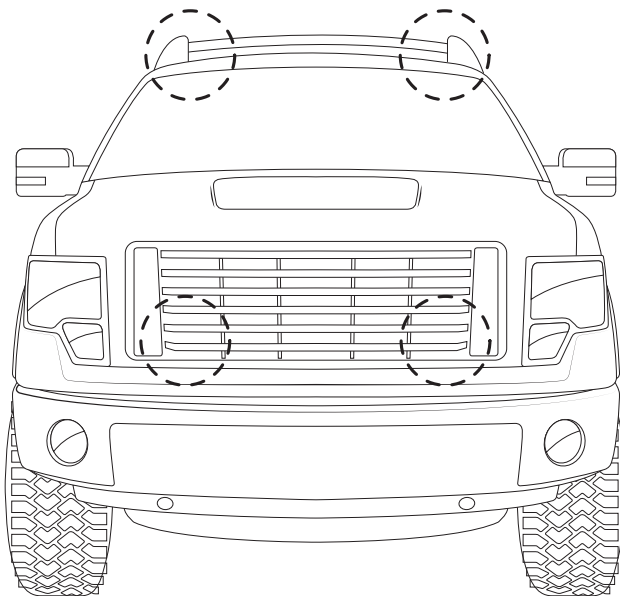

WARNINGS

IMPORTANT SAFETY INSTRUCTIONS

1. SAVE THESE INSTRUCTIONS- This manual contains important safety and operating instructions.
2. Before using this product, read all instructions and cautionary markings.
3. Do not expose the bare wires to rain, moisture, or snow.
4. Use of an attachment not recommended or sold by the manufacturer may result in a risk of fire, electric shock, or injury to persons.
5. Do not operate with damaged Flood Light – replace it immediately.
6. Do not operate Flood Light if it has received a sharp blow, been dropped, or otherwise damaged in any way; take it to a qualified serviceperson.
7. Do not disassemble Flood Light; take it to a qualified serviceperson when service or repair is required. Incorrect reassembly may result in a risk of electric shock or fire.
8. To reduce risk of electric shock, unplug Flood Light before attempting any maintenance or cleaning. Turning off controls will not reduce this risk.

CAUTIONS

Check your state or provincial laws before installing. Vehicle owner must comply with all applicable laws. This product is intended solely for off road purposes. Manufacturer and seller assume no liability for installation or use, which are solely the responsibility of the purchaser. This product is not DOT approved and is designed and intended for off road uses only.

1. Do not install or use product if it, in any way, impairs the safe operation of your vehicle.
2. Follow manufacturer's instructions to ensure the product is properly and safely installed.
3. Check your state or provincial laws before installing. Vehicle

INSTALLATION

Tools Required:

- Power Drill and 8.5mm Drill Bit (not included)
- Wrench (not included)

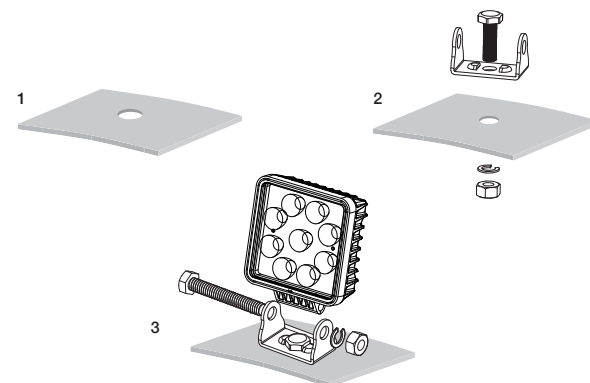

1. Choose a suitable mounting location for the Flood Light. Make sure the location is strong enough to hold the Flood Light.
-Mark one hole for the Mounting Bracket for a precise installation.
-Make sure nothing beneath will be damaged after the hole is drilled.
-Drill the hole with a 8.5mm Drill Bit.

2. Secure the Mounting Bracket to the surface with the short Screw, Spring Washer and Flat Washer.

3. Attach the Flood Light to the Mounting Bracket and secure with the Long Screw, Nut and Spring Washer. Adjust the Flood Light to your desired beam angle and tighten the Long Screw. Be sure not to over-tighten the screw after the adjustment.

*Optional Flat Washers can be inserted inside the Mounting Bracket for better fitting.

NOTE: - Install Flood Light on metal or durable materials only.
- Every install is unique and we provide simple installation information but professional installation is highly recommended.

owner must comply with all applicable laws.

4. This product is intended solely for off road purposes. Manufacturer and Seller assume no liability for installation or use, which are solely the responsibility of the purchaser.
5. This product is not DOT approved and is designed and intended for off road uses only.
6. The Manufacturer and Seller are not responsible or liable for consequential, incidental, or indirect damages, whether to person or property, resulting from the installation or improper use of this product.

⚠ WARNING: This product can expose you to chemicals including DEHP and DINP, which are known to the State of California to cause cancer and birth defects or other reproductive harm. For more information go to www.P65Warnings.ca.gov.

SPECIFICATIONS

Working Voltage:	DC 12-24V
LED Power:	36W
Color Temperature:	5,700K White
Maximum Amperage Draw:	2A (12V) / 1A (24V)
Raw Lumens:	3,600LM
Effective Lumens:	2,290LM
Housing IP Rating:	IP68
Beam Type:	Flood

Wire Connection

Black wire (-) negative, ground connection.
Red wire (+) positive, Flood Light.
Fuse light at power source.
Use 16-14 gage wire.

WARRANTY

TYPE S LIMITED WARRANTY

TYPE S warrants, to the original purchaser, that its products are free from defects in material and workmanship for 1 year from the date of original purchase. Where permitted by law, TYPE S's liability shall be limited to that set forth in this limited express warranty. This limited express warranty shall be the exclusive remedy of the purchaser and TYPE S makes no other warranty of any kind aside from the limited express warranty stated above.

NOTE: Warranty only applies for North American customers of purchases made in North America.

CONDITIONS OF WARRANTY

If during the 1 year warranty period your new product is found to be defective, TYPE S will repair such defect, or replace the product, without charge for parts or labor subject to the following conditions:

1. All repairs must be performed by TYPE S.
2. All warranty claims must be accompanied by a copy of the sales receipt or bill of sale.
3. The equipment must not have been altered or damaged through negligence, accident, improper operation, or failure to follow the product instructions for installation, use, or care.
4. The replacement of parts is excluded from the warranty when replacement is necessary due to normal wear and tear.
5. Repair or replacement parts supplied by TYPE S under this warranty are protected only for the unexpired portion of the original warranty.
6. This is a "repair or replace" warranty only, and does not cover the costs incurred for the installation, removal or reinstallation of the product, or damage to any mobile phone, electronic device or vehicle.

OWNER'S RESPONSIBILITIES:

TYPE S will make every effort to provide warranty service within a reasonable period of time. **SHOULD YOU HAVE ANY QUESTIONS ABOUT SERVICE RECEIVED OR IF YOU WOULD LIKE ASSISTANCE IN OBTAINING SERVICE, PLEASE CALL TOLL FREE 1.866.294.9244 DURING REGULAR BUSINESS HOURS, MONDAY THROUGH FRIDAY 8:00 AM TO 5:00 PM (Pacific Standard Time).** For customer service and technical support, please call us at 1.866.294.9244 or email us at info@typesauto.com. If at that time it is determined that a replacement unit is needed, the support representative will issue a Return Authorization and instruct on how to get a new unit. TYPE S makes no other warranty of any kind aside from the limited express warranty stated herein.

PACKAGE INCLUDES

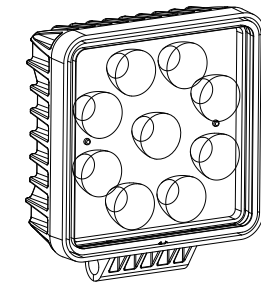

1 x 4" Flood Light

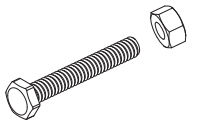

1 x Long Screw and Nut (M8)

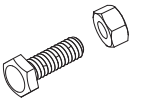

1 x Short Screw and Nut (M8)

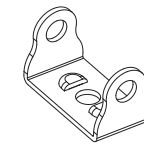

1 x Mounting Bracket



2 x Spring Washers and Flat Washers

TOOLS NEEDED (NOT INCLUDED)

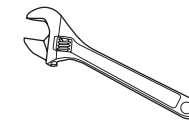

Wrench

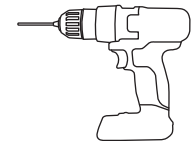

Power Drill

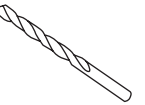

8.5mm Drill Bit

DISCLAIMER OF WARRANTIES, INCLUDING WARRANTY OF MERCHANTABILITY AND WARRANTY OF FITNESS FOR PARTICULAR PURPOSE: EXCEPT AS SPECIFICALLY SET FORTH HEREIN, NO WARRANTY OR REPRESENTATION, EXPRESS OR IMPLIED, IS MADE AS TO THE FLOOD LIGHT. TYPE S AND/OR ITS AFFILIATES EXPRESSLY DISCLAIMS, WITHOUT LIMITATION, ANY STATUTORY WARRANTIES AND ALL IMPLIED WARRANTIES, INCLUDING ANY IMPLIED WARRANTY OF MERCHANTABILITY OR FITNESS FOR A PARTICULAR PURPOSE.

TYPE S and/or its affiliates are not responsible for a user's intended or actual use of the Flood Light. In no event shall TYPE S and/or its affiliates have any liability for any losses (whether direct or indirect, in contract, tort or otherwise) incurred in connection with the Flood Light, including but not limited to damaged property, personal injury and/or loss of life. Neither shall TYPE S and/or its affiliates have any liability for any decision, action taken based on relying on the stability or performance of the Flood Light. TYPE S and/or its affiliates, the manufacturer, distributor and seller shall not be liable for any injury, loss or damage, incidental or consequential, arising out of the use or intended use of the product.

Terra Pro™ 4" Flood Light
LM58280
Responsible Party:
TYPE S
2975 Red Hill Ave., Ste. 100, Costa Mesa,
CA 92626, U.S.A.
Tel: 1.866.294.9244



A Horizon Brands Company
2975 Red Hill Ave., Ste. 100, Costa Mesa,
CA 92626, U.S.A.
1.866.294.9244 | info@typesauto.com
©2021 TYPE S. All rights reserved.
www.typesauto.com

CONNECT WITH US @TypeSAuto

Made in China

ML-58280_V1