

TOURING ITEMS
TYPES

ADJUSTABLE WIRELESS BACKUP CAMERA

Solar Powered 1080P App View

WP ITM. BT534014
Care & Use Instructions



**Important, retain for future reference:
Read carefully**



TABLE OF CONTENTS

1. Introduction	3
2. Package Contents	4
3. Product Specifications	5
4. Product Dimension	5
5. Product Overview	6
6. Before You Install	7
7. Installation Guide	8
8. Downloading and use the TYPE S Drive App	10
9. App Setup	11
10. Safety Information..	14
11. Maintenance & Warranty	16
12. General Information	19

1. INTRODUCTION

Please read all of the installation instructions carefully before installing the product. Improper installation will void the manufacturer's warranty. The installation instructions do not apply to all types of vehicles, and are written as guidelines to assist in installing the product.

Consult an experienced technician if you are not comfortable installing the product. You can also contact TYPE S at **866.294.9244** to speak to one of our installation specialists if you have any specific questions regarding the Backup Camera.

BEFORE using the Backup Camera, please read the safety information provided in this user manual. ALWAYS use the product as outlined in this user manual.

Please make sure to read and understand all local laws and regulations regarding cameras and their use in a vehicle. Laws vary by state.

2. PACKAGE CONTENTS

1

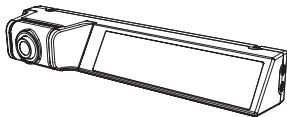

2

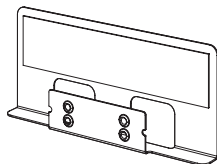

3



4

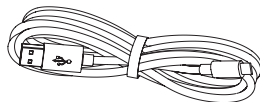

5



6

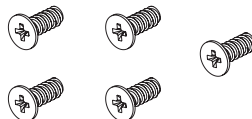

7

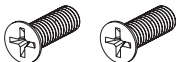

8

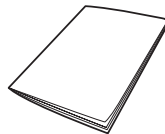

1. 1 x Adjustable Wireless Backup Camera
2. 1 x Universal Mounting Plate
3. 1 x Installation Plate
4. 1 x 33" / 84cm USB-C Cable

5. 2 x Tapping Screw (6.3mm x 30mm) (Silver)
6. 5 x Tapping Screw (3mm x 8mm) (Silver)
7. 2 x Metric Screw (M6 x 18mm) (Silver)
8. 1 x User Manual & Quick Installation Guide

3. PRODUCT SPECIFICATIONS

Frequency:	2.4 GHz
Operating Voltage:	DC 5V (USB-C)
Operating Temperature:	14°F~122°F (-10°C~50°C)
Camera Water Resistance:	IP67 Rating
Battery Capacity:	2,500mAh
Maximum Signal Range:	33 Feet / 10 Meters (without interference or obstruction)

4. PRODUCT DIMENSION

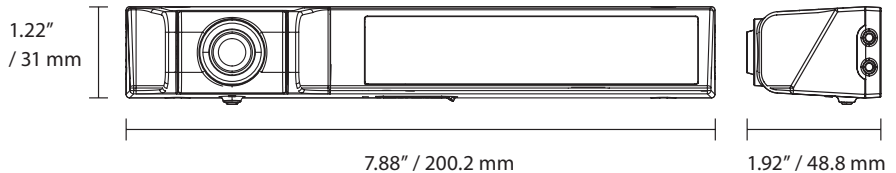

5. PRODUCT OVERVIEW

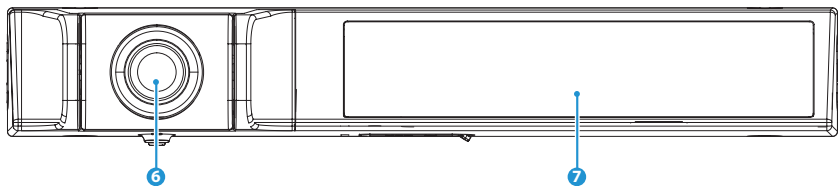
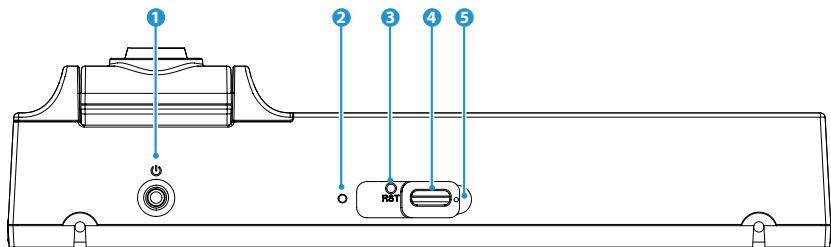

1. Power Button
2. LED Indicator
3. Reset Button
4. USB-C Charging Port

5. Charging Indicator
6. Camera Lens
7. Solar Panel

6. BEFORE YOU INSTALL

1. Fully charge the camera: Flip open the charging port lid and connect it to a power source using the 33" / 84cm USB-C Cable provided.
2. Test the product by powering it on and connecting it to the TYPE S Drive App (page 10).

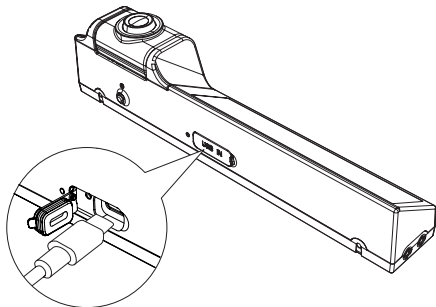

NOTE:

Though the camera already comes with 90% battery charge out of the box, we still recommend charging it for 5-6 hours before installation for the best performance.

In order to reduce the risk of fire or electric shock, an adapter shall be chosen that is suitable for the application and is certified as a Class 2 or LPS power supply or power adapter.

7. INSTALLATION GUIDE

OPTION 1 - MOUNT WITH INSTALLATION PLATE

- 1 Remove the license plate you'd like to install the camera over from your vehicle.



- 2 Attach the Installation Plate onto your license plate and back onto your vehicle using either the M6 x 18mm Metric Screws or the 6.3mm x 30mm Tapping Screws.

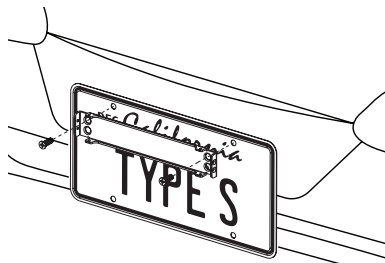

- 3 Attach the camera onto the Installation Plate and secure it using the 3mm x 8mm Tapping Screws (1 extra piece of Tapping Screw for spare).

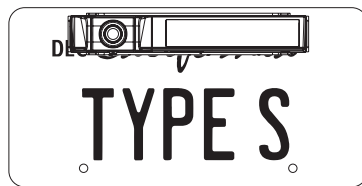
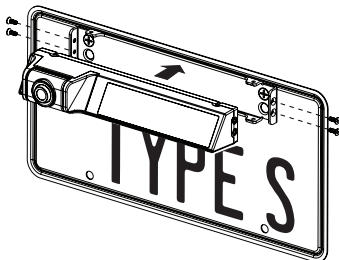

OPTION 2 - MOUNT WITH UNIVERSAL MOUNTING PLATE

- 1 Attach the camera onto the Universal Mounting Plate using the 3mm x 8mm Tapping Screws (1 extra piece of Tapping Screw for spare).

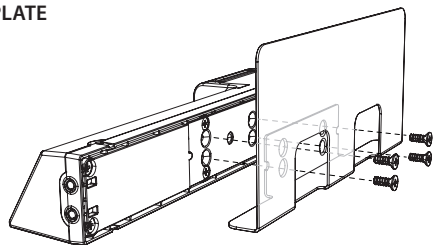

- 2 Peel off the 3M™ VHB Double-sided Tape Backer from the Universal Mounting Plate and attach it onto your license plate.

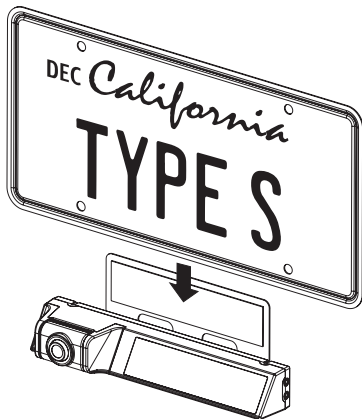

- 3 Install the license plate and the camera back onto your vehicle.



8. DOWNLOADING AND USE THE TYPE S DRIVE APP

Scan below QR code or search "TYPE S Drive" in the App Store or Google Play using your smartphone. Download and install the App.

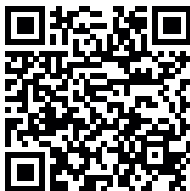

Compatible with iPhone 4s and higher, iPad3, iPad Mini, iPad Air and higher, and iPod touch 5th Generation and higher. Requires iOS 9.0 or higher.



Compatible with phones with Android™ 5.0 or higher.

Once installed, open the App and begin enjoying your TYPE S Drive App.

NOTE: The App is only available on smartphones with Apple iOS 9 or newer, and Android 5.0 or newer. The TYPE S Drive App is not accessible from tablets, browsers, or PCs.



9. APP SETUP

Pairing The Camera

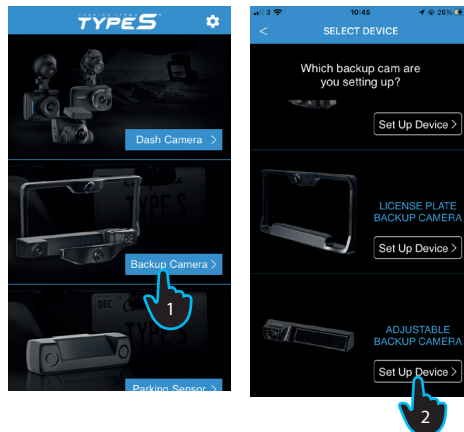
1. Run the TYPE S Drive App and click **Backup Camera**.
2. Scroll down the device list and select **ADJUSTABLE BACKUP CAMERA**. Click **Set Up Device**.





Android Device

3. Click  and select  Pair Camera.
4. When the App finds "TYPE_S_BUC05_1080P_XXXXXX", click **Connect**.
5. Once connected, you will be able to see the Backup Camera's real-time view through the App.



iOS Device (Follow Steps 1-2 from previous instructions)

3. When prompted, please click **Settings** to turn on Bluetooth
4. Click  and select  Pair Camera.
5. When the App finds "TYPE_S_BUC05_1080P_XXXXXX", click **Connect**.
6. Once connected, you will be able to see the Backup Camera's real-time view through the App.

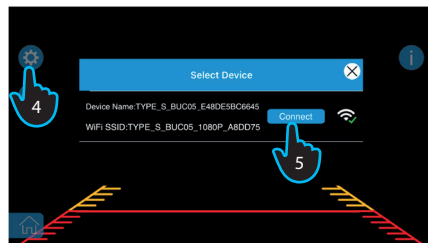
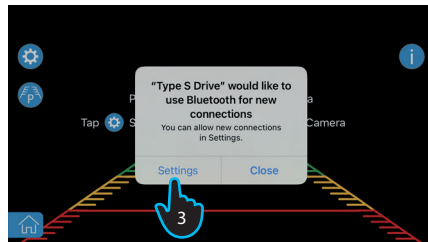

CAMERA STATUS & LED INDICATORS

Power / Mode Status	LED Indicators
Power On Click once on the power button.	Blue LED light flashes twice.
Power Off Press & hold the power button for more than 2 seconds or until you see the red LED light flashes once.	Red LED light flashes once.
Factory Reset While the camera is on, press & hold the power button for more than 5 seconds or until you see the blue LED light flashes 5 times.	Blue LED light flashes 5 times.
Hardware Reset If the camera does not function properly or appears to be unresponsive, insert a paper clip into the power reset hole for a hardware reset.	Red LED light flashes once.
Low Voltage Protection	Red LED light flashes continuously.

10. SAFETY INFORMATION

IMPORTANT SAFETY INSTRUCTIONS

1. SAVE THESE INSTRUCTIONS – This manual contains important safety and operating instructions of Model BT534014.
2. Before using the product, read all instructions and cautionary markings.
3. Do not expose Backup Camera to rain, moisture, or snow.
4. Use of an attachment not recommended or sold by the product manufacturer may result in a risk of fire, electric shock, or injury to persons.
5. To reduce risk of damage to Backup Camera, pull by Backup Camera rather than cable when disconnecting from USB port.
6. Make sure the cable is located so that it will not be stepped on, tripped over, or otherwise subjected to damage or stress.
7. Do not operate the Backup Camera with damaged cable – replace it immediately.
8. Do not operate the Backup Camera if it has received a sharp blow, been dropped, or otherwise damaged in any way; take it to a qualified serviceperson.
9. Do not disassemble the Backup Camera; take it to a qualified serviceperson when service or repair is required. Incorrect reassembly may result in a risk of electric shock or fire.
10. To reduce risk of electric shock, unplug the Backup Camera before attempting any maintenance or cleaning. Turning off controls will not reduce this risk.

WARNING: A failure to read and follow these warnings and instructions may result in a serious accident, including damaged property or a serious injury, including loss of life.

- The Backup Camera is designed as an aid to the driver in detecting large stationary objects to help avoid damaging the vehicle. However, you, the driver, must use it safely and properly. Use of the Backup Camera is not a substitute for safe, proper and legal driving.
- Never back up while looking only at the App screen. You should always check behind and around the vehicle when backing up just as you would if the vehicle did not have the Backup Camera. Always make sure your intended path is clear. If you back up while looking only at the App screen, you may hit a vehicle, pedestrian, bicyclist, child, pet or other object resulting in injury or death. Always back up slowly.
- Never depend on the Backup Camera entirely when backing up. The image on the App screen is different from actual conditions. Objects viewed on the App screen differ from actual distance because a wide-angle lens is used. Objects on the App screen will appear visually opposite than when

viewed in the rear view and outside mirrors. Use the inside mirror or glance over your shoulder to properly judge distances to other objects.

- The area displayed by the Backup Camera is limited. The Backup Camera does not display objects that are close to or below the bumper, underneath the vehicle, or objects out of the camera's field of view. The area displayed on the App screen may vary according to vehicle orientation or road conditions.
- Be sure to check the camera's position and mounting angle before each use.
- Make sure the trunk, hatch, or backdoor is completely and securely closed when backing up.
- If the back of the vehicle is hit, the position and mounting angle of the Backup Camera may change.
- When washing the vehicle with high pressure water, be sure not to spray it around the Backup Camera. Otherwise, water may enter the camera unit causing water condensation on the lens, a malfunction, fire or an electric shock.
- Do not strike the Backup Camera. It is a precision instrument. Otherwise, it may malfunction or cause damage resulting in a fire or an electric shock.
- This product will only provide images of items that are within the field of view of the Backup Camera. Thus, it is imperative that the Backup Camera should be kept clean and unobstructed, and should be mounted so that its field of view includes the entire area behind your vehicle.
- Adhere to all applicable traffic laws and motor vehicle regulations applicable to the device.
- Consult local laws and regulations for any restrictions on installation or use.
- Never allow children to play with the device. Small parts may be a choking hazard.
- If you replace the tires, the area displayed on the App screen may change and you may need to adjust the camera.
- There is a plastic cover over the Backup Camera. Do not scratch the cover when cleaning dirt or snow from the cover.
- The Backup Camera has a water resistant construction. Do not detach, disassemble or modify it. This may cause incorrect operation. Backup Camera is waterproof.
- Do not submerge Backup Camera in water, which can cause internal damage to the camera.
- If the temperature changes rapidly, such as when hot water is poured on the vehicle in cold weather, the system may not operate normally. The Backup Camera can withstand the effects of rain, snow, and inclement weather.
- When strong light directly enters a camera, objects may not be displayed clearly.
- The App screen may flicker under fluorescent light.

- The colors of objects on the App screen may differ somewhat from those of the actual objects.
- If dirt, rain or snow attaches to the Backup Camera, the backup image may not display clearly. If water droplets, snow or mud adhere to the camera lens, rinse with water and wipe with a dry cloth.
- Do not use alcohol or thinner to clean the camera. This will cause discoloration. To clean the camera, wipe with a clean cloth dampened with mild cleaner diluted with water and then wipe with a dry cloth.
- Your mobile device and the Backup Camera will remain connected up to 33 Feet / 10 Meters without any obstacles or interference.
- ALWAYS engage Parking/Emergency/Hand Brakes of the vehicle when testing the system.

SAFETY AROUND AND BEHIND OTHER VEHICLES

Using the Backup Camera is not enough to completely overcome a vehicle's blind spot. Many preventable injuries and deaths occur in driveways or parking lots when drivers do not see children, pets, or others near their vehicles. Here are a few safety tips that will help you to avoid a back-over accident:

- Walk completely around your vehicle before getting in. Check for kids, toys, and pets before entering the vehicle and starting the engine.
- Know where children are. Have children stand in a place where they are in full view.
- Be aware of young children. Young children are small and hard to see.
- Parents, caregivers and all adults need to be vigilant in supervising children, especially when children are in the yard, driveway or parking lot playing near parked cars.
- Roll down your window so you will be able to hear what is happening outside your vehicle.
- Owners of SUVs, trucks, and vans need to take extra care to avoid hitting or running over a child.
- Teach children to move away from a vehicle whenever it is started.

11. MAINTENANCE & WARRANTY

CLEANING

- If dirt, rain or snow attaches to the camera, the backup image may not display clearly. If water droplets, snow or mud adhere to the camera lens, rinse with water and wipe with a dry cloth.
- Do not use alcohol, benzene or thinner to clean the camera. This will cause discoloration. To clean the camera, wipe with a clean cloth dampened with mild cleaner diluted with water and then wipe with a dry cloth.

WARRANTY

• TYPE S

LIMITED WARRANTY

TYPE S warrants, to the original purchaser, that its products are free from defects in material and workmanship for 1 year from the date of original purchase. Where permitted by law, TYPE S liability shall be limited to that set forth in this limited express warranty. This limited express warranty shall be the exclusive remedy of the purchaser and TYPE S makes no other warranty of any kind aside from the limited express warranty stated above.

NOTE: Warranty only applies for North American customers of purchases made in North America.

CONDITIONS OF WARRANTY

If during the 1 year warranty period your new product is found to be defective, TYPE S will repair such defect, or replace the product, without charge for parts or labor subject to the following conditions:

1. All repairs must be performed by TYPE S.
2. All warranty claims must be accompanied by a copy of the sales receipt or bill of sale.
3. The equipment must not have been altered or damaged through negligence, accident, improper operation, or failure to follow the product instructions for installation, use, or care.
4. The replacement of parts is excluded from the warranty when replacement is necessary due to normal wear and tear.
5. Repair or replacement parts supplied by TYPE S under this warranty are protected only for the unexpired portion of the original warranty.
6. This is a "repair or replace" warranty only, and does not cover the costs incurred for the installation, removal or reinstallation of the product, or damage to any mobile phone device or vehicle.

OWNER'S RESPONSIBILITIES:

TYPE S will make every effort to provide warranty service within a reasonable period of time. SHOULD YOU HAVE ANY QUESTIONS ABOUT SERVICE RECEIVED OR IF YOU WOULD LIKE ASSISTANCE IN OBTAINING SERVICE, PLEASE CALL TOLL FREE 1.866.294.9244 DURING REGULAR BUSINESS HOURS MONDAY THROUGH FRIDAY 8:00 AM TO 5:00 PM.

NOTE: Toll Free # is for North America Customers ONLY. See Customer service section for customer contact numbers for other regions/offices.

For customer service and technical support, please call us at 1.866.294.9244. If at that time it is determined that a replacement unit is needed, the support representative will issue a Return Authorization and instruct on how to get a new unit. TYPE S makes no other warranty of any kind aside from the limited express warranty stated herein.

DISCLAIMER OF WARRANTIES, INCLUDING WARRANTY OF MERCHANTABILITY AND WARRANTY OF FITNESS FOR PARTICULAR PURPOSE: EXCEPT AS SPECIFICALLY SET FORTH HEREIN, NO WARRANTY OR REPRESENTATION, EXPRESS OR IMPLIED, IS MADE AS TO THE BACKUP CAMERA. EXCEPT AS EXPRESSLY SET FORTH HEREIN, TYPE S AND/OR ITS AFFILIATES EXPRESSLY DISCLAIMS, WITHOUT LIMITATION, ANY STATUTORY WARRANTIES AND ALL IMPLIED WARRANTIES, INCLUDING ANY IMPLIED WARRANTY OF MERCHANTABILITY OR FITNESS FOR A PARTICULAR PURPOSE.

TYPE S and/or its affiliates do not guarantee or promise that the user of Backup Camera will not be in an accident or otherwise not collide with an object and/or person. Our Backup Camera is not intended in any way to be a substitute for careful and cautious driving or for the consistent adherence to all applicable traffic laws and motor vehicle safety regulations.

TYPE S and/or its affiliates are not responsible for a user's intended or actual use of the Backup Camera. In no event shall TYPE S and/or its affiliates have any liability for any losses (whether direct or indirect, in contract, tort or otherwise) incurred in connection with the Backup Camera, including but not limited to damaged property, personal injury and/or loss of life. Neither shall TYPE S and/or its affiliates have any liability for any decision, action or inaction taken by any person in reliance on the Backup Camera, or for any delays, inaccuracies and/or errors in connection with the Backup Camera and its functioning.

TYPE S and/or its affiliates shall have no responsibility or liability for damage and/or injury resulting from accidents occurring with vehicles having the installed, and TYPE S and/or its affiliates, the manufacturer, distributor and seller shall not be liable for any injury, loss or damage, incidental or consequential, arising out of the use or intended use of the product.

12. GENERAL INFORMATION

CUSTOMER SERVICE/CONTACT

IF YOU ARE EXPERIENCING ANY ISSUES WITH THE PRODUCT DURING OPERATION, DO NOT RETURN THE PRODUCT TO THE STORE. CONTACT TYPE S DIRECTLY FOR INSTRUCTIONS ON HOW TO RETURN/ EXCHANGE THE PRODUCT.

FCC Compliance Statement:

This device complies with Part 15 of the FCC rules. Operation is subject to the following two conditions: (1) This device may not cause harmful interference, and (2) this device must accept any interference received, including interference that may cause undesired operation.

WARNING: Changes or modifications to this unit not expressly approved by the party responsible for compliance could void the user's authority to operate the equipment. The manufacturer is not responsible for any radio or TV interference caused by unauthorized modifications or change to this equipment. Such modifications or change could void the user's authority to operate the equipment.

NOTE: This equipment has been tested and found to comply with the limits for a Class B digital device, pursuant to part 15 of the FCC Rules. These limits are designed to provide reasonable protection against harmful interference in a residential installation. This equipment generates uses and can radiate radio frequency energy and, if not installed and used in accordance with the instructions, may cause harmful interference to radio communications. However, there is no guarantee that interference will not occur in a particular installation. If this equipment does cause harmful interference to radio or television reception, which can be determined by turning the equipment off and on, the user is encouraged to try to correct the interference by one or more of the following measures:

- Reorient or relocate the receiving antenna.
- Increase the separation between the equipment and receiver.
- Connect the equipment into an outlet on a circuit different from that to which the receiver is connected.
- Consult the dealer or an experienced radio/TV technician for help.

This equipment complies with FCC RF radiation exposure limits set forth for an uncontrolled environment. In order to avoid the possibility of exceeding the FCC radio frequency exposure limits, human proximity to the antenna shall not be less than 20cm during normal operation.

Adjustable Wireless Backup Camera

BT534014

Responsible Party:

TYPE S

2975 Red Hill Ave., Ste. 100,
Costa Mesa, CA 92626, U.S.A.

Tel: 1-866-294-9244

iPhone, iPad, Mac and iPod touch are trademarks of Apple Inc.

Android is a trademark of Google Inc.

3M VHB™ is a trademark of 3M Company.

Horizon Brands Company
TYPES

A Horizon Brands Company

2975 Red Hill Ave., Ste. 100, Costa Mesa, CA 92626, U.S.A.

1.866.294.9244 | info@typesauto.com

©2023 TYPE S. All right reserved.