

TOURING ITEMS
TYPES[®]

LC 360 LED VIDEO LIGHT & POWER BANK

WP ITM. LM533425

**Important, retain for future reference:
Read carefully**

PRODUCT IMAGE



LED Video Light



Cold Shoe Mount Adapter



User Guide



USB-C/USB-A Charging Cable



PACKAGE CONTENTS

Warranty Card



Carry Pouch



SPECS

Battery Capacity	27.72Wh 7200mAh 3.85V
USB Type C Input/Output	5V/2.4A
Storage Temperature	-4°F ~ 113°F / -20°C ~ 45°C
Operating Temperature	-4°F ~ 95°F / -20°C ~ 35°C
Charging Temperature	14°F ~ 113°F / -10°C ~ 45°C
CRI	95
RGB Color Gamut	0~360° Full Gamut
Color Temperature	2600~9000K
Color Saturation Adjustment	0~100
Brightness Adjustment	0~100%
Lumen	750lm
High Temp. Protection	When the temperature is high, the display flashes [] high temperature warning. When the ambient temperature is too high or after long, continuous use, a high temperature warning sign will appear. If the user continues use, the lights and power output (USB-C charging) will turn off automatically. Once the heat reduces to a safe temperature, the video light can be restarted.

PRODUCT OVERVIEW

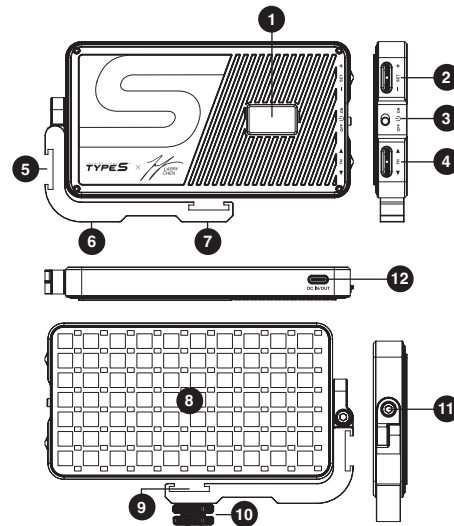

1. High Definition Display Screen
2. SET Menu Adjust Dial Wheel
3. Power Switch
4. FN Adjustment Dial Wheel
5. Cold Shoe Socket
6. 1/4 Screw Hole
7. 1/4 Screw Hole
8. LED Lamp Bead
9. Cold Shoe Socket
10. Cold Shoe Base
11. Universal Foot Screw Hole
12. Type-C Charging Port

MODE SETTINGS CCT MODE

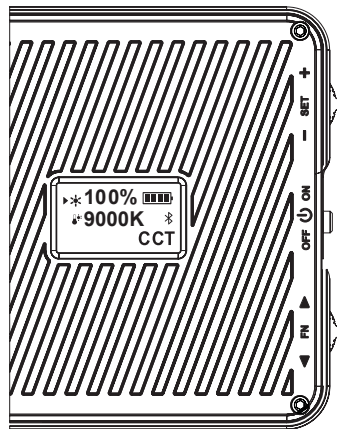

Press the [**SET**] dial wheel until the lower right corner of the screen displays [**CCT**], rotate the [**FN**] dial wheel [**▲**] [**▼**] to adjust the color temperature from 2600K to 9000K; rotate the [**SET**] dial wheel [**+**] [**-**] to adjust the brightness from 0 to 100%.



Brightness Adjustment

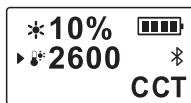

Color Temperature Adjustment

MODE SETTINGS RGB MODE

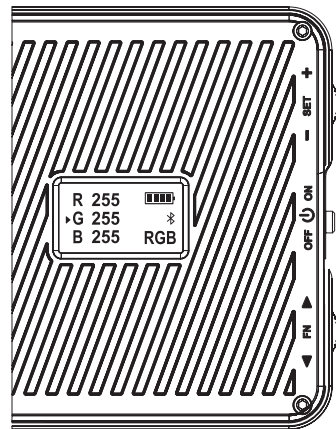

Press the [**SET**] wheel, when the lower right corner of the screen shows [**RGB**], press the [**FN**] wheel to switch the selection, rotate the [**FN**] wheel [**▲**] [**▼**] to adjust the R-red light, G-green light, B-blue light parameter values from 0 to 255.

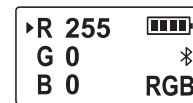

R-Red Light

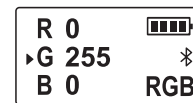

G-Green Light

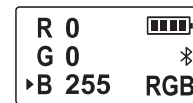

B-Blue Light

MODE SETTINGS HSI MODE

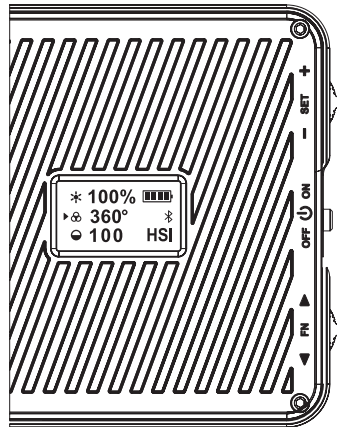

Press the [SET] dial wheel until the lower right corner of the screen displays [HSI], press the [FN] dial to toggle the selection and rotate the [FN] dial wheel [▲] [▼] to adjust the color gamut from 0 to 360° and saturation from 0 to 100; rotate the [SET] dial wheel [+] [-] to adjust the brightness from 0 to 100%.

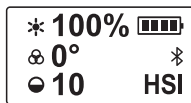

Brightness Adjustment

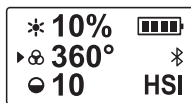

Full Color Gamut Adjustment

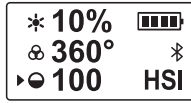

Color Saturation Adjustment

MODE SETTINGS SCN MODE

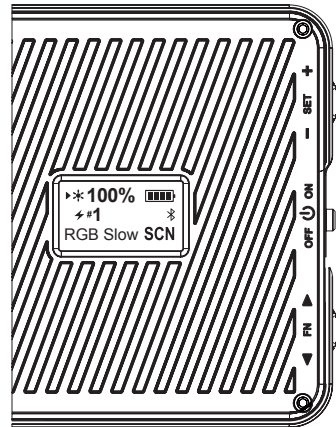

Press the [SET] dial and when [SCN] is displayed in the lower right corner of the screen, rotate the [FN] dial [▲] [▼] to select 1~21 effects and rotate the [SET] dial [+] [-] to adjust the brightness from 0 to 100%.

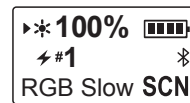

Brightness Adjustment

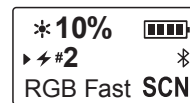

Scene Adjustment

MODE SETTINGS SCN MODE (21 EFFECTS)

#1 RGB Slow

#2 RGB Fast

#3 Laser Show

#4 Fireworks

#5 EMT 1

#6 EMT 2

#7 EMT 3

#8 Police 1

#9 Police 2

#10 Police 3

#11 FireTruck 1

#12 FireTruck 2

#13 FireTruck 3

#14 Fire

#15 Candle

#16 Lightning 1

#17 Lightning 2

#18 Paparazzi

#19 SOS

#20 Bulb Flicker

#21 TV Screen

Install the TYPE S LED APP on your smart device. Scan below QR code or search for the TYPE S LED APP in the APP Store or Google Play.

🔍 Type S LED

Download on the
App Store



Compatible with iPhone 4s & higher, iPad3, iPad Mini, iPad Air & higher, and iPod touch 5th Generation & higher. Requires iOS 9.0 or higher.

GET IT ON
Google Play



Compatible with phones with Android™ 4.3 or higher.
Note: not all Android™ phones are equipped with Bluetooth® v5.3 required for this application.

APPLICATION - ADDING DEVICE

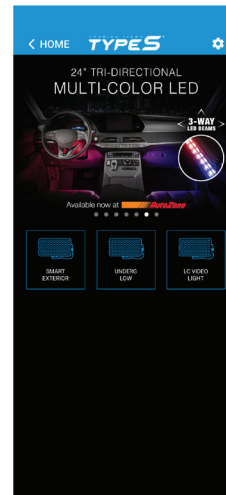

1. Chose the LC video Light

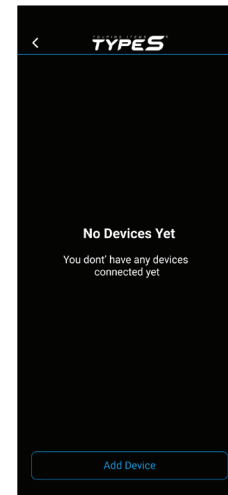

2. Press Add Device

APPLICATION - ADDING DEVICE

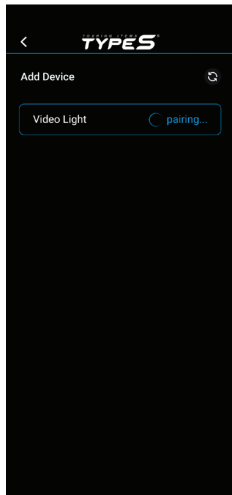

3. Select the Device you wanted.

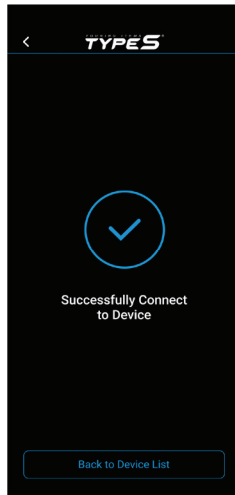

4. When paired, then it will show successful.

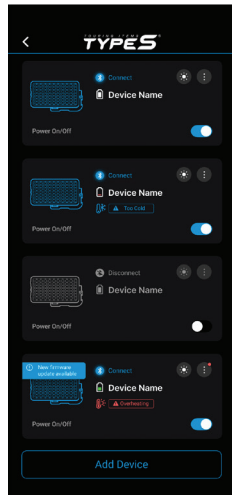

5. After Paired, it will go to main page directly.

INSTALLATION

Use of the Multifunctional Bracket

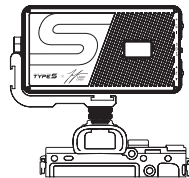

Connect Hot Shoe Base

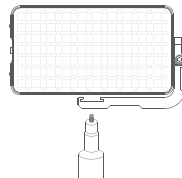

Connect Cold Shoe Base

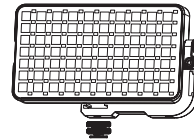

Connect Light Stand

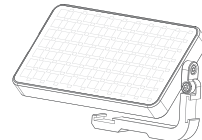

Desktop Stand

NOTE: This product does not include microphone, light stand or camera.

INSTALLATION

WARNINGS

Cold Shoe Bracket Installation

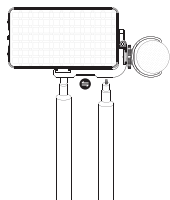

Install When Shooting
Horizontally



Install When Shooting
Vertically

Bracket Rotation Adjustment

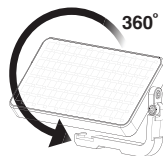

360° Rotation

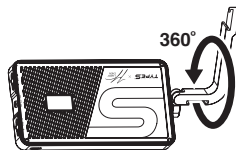

360° Rotation

NOTE: This product does not include microphone, light stand or camera.

INSTRUCTIONS PERTAINING TO RISK OF FIRE, ELECTRIC SHOCK OR INJURY TO PERSONS

- Do not allow this product to become wet. Exposure to excessive moisture will damage the unit.
- Do not immerse the product in water.
- Do not operate the product in explosive atmospheres, such as in the presence of flammable liquid, gas or dust.
- Do not modify or disassemble this product.
- Do not store in locations where the temperature may exceed 104°F (40°C).
- Under extreme heat conditions, battery leakage may occur. Avoid contact with your skin. In case of skin or eye contact, rinse immediately with clean water and seek medical attention.
- If battery leakage occurs, take it to your local battery recycling center for disposal. Do not attempt to use.

WARNINGS

BATTERY DISPOSAL

The battery is self-contained and not consumer replaceable. The battery must be disposed of properly when it no longer holds a charge. Proper charging practices will increase the life of the product. For information on battery recycling, call toll-free 800-822-8837.

For information regarding air travel safety with batteries please check the U.S. Department of Transportation prior to travel at: <http://phmsa.dot.gov/safetravel/batteries> or contact your airline if traveling from a country outside the U.S.

Note: The Power Bank gives 27.72 watt hours of power.

WARNINGS

IMPORTANT SAFETY INSTRUCTIONS

WARNING - When using this product, basic precautions should always be followed, including the following:

- Read all the instructions before using the product.
- To reduce the risk of injury, close supervision is necessary when the product is used near children. Children should not operate this device unless under strict supervision by a person responsible for their safety.
- Do not put fingers or hands into the product.
- Do not use any attachment that is not sold by device manufacturer which may result in a risk of fire, electric shock, or injury to persons.
- To reduce risk of damage to the electric plug and cord, pull the plug rather than the cord when disconnecting the device.
- Do not use an appliance that is damaged or modified. Damaged or modified appliance may exhibit unpredictable behavior resulting in fire, explosion or risk of injury.
- Do not operate the device with a damaged cord or plug, or a damaged output cable.
- Do not disassemble the device; take it to a qualified service person when service or repair is required. Incorrect reassembly may result in a risk of fire or electric shock.
- To reduce the risk of electric shock, unplug the device from the outlet before attempting any instructed servicing.

WARNINGS

WARNING - RISK OF EXPLOSIVE GASES.

- The device shall be stored indoors and protected from the elements;
- The unit shall not be charged outdoors;
- When in use, steps should be taken to reduce the exposure to rain, sleet, snow, and the like.
- Do not overcharge the internal battery.
- This product is suitable for use in home, office, household workshop or garage. Do not operate in rough environment such as repair facility.

WARNING - To reduce the risk of injury, do not stare directly into the flashlight when it is on. Serious eye injury could occur.

- Do not touch or hold the flashlight by the lens or the top of the flashlight. To reduce the risk of injury, only handle the flashlight by the handle and casing.

FCC COMPLIANCE STATEMENT

This device complies with Part 15 of the FCC rules. Operation is subject to the following two conditions:

1. This device may not cause harmful interference, and
2. This device must accept any interference received, including interference that may cause undesired operation.

Warning: Changes or modifications to this unit not expressly approved by the party responsible for compliance could void the user's authority to operate the equipment. The manufacturer is not responsible for any radio or TV interference caused by unauthorized modifications or change to this equipment. Such modifications or change could void the user's authority to operate the equipment.

Note: This equipment has been tested and found to comply with the limits for a Class B digital device, pursuant to part 15 of the FCC Rules. These limits are designed to provide reasonable protection against harmful interference in a residential installation. This equipment generates, uses and can radiate radio frequency energy and, if not installed and used in accordance with the instructions, may cause harmful interference to radio communications. However, there is no guarantee that interference will not occur in a particular installation. If this equipment does cause harmful interference to radio or television reception, which can be determined by turning the equipment off and on, the user is encouraged to try to correct the interference by one or more of the following measures:

- Reorient or relocate the receiving antenna.
- Increase the separation between the equipment and receiver.

- Connect the equipment into an outlet on a circuit different from that to which the receiver is connected.
- Consult the dealer or an experienced radio/TV technician for help.

This equipment complies with FCC RF radiation exposure limits set forth for an uncontrolled environment.

LC 360 LED VIDEO LIGHT & POWER BANK

Model: LM533425

Responsible Party:

TYPE S

2975 Red Hill Ave., Ste. 100, Costa Mesa, CA 92626

Tel: 1-866-294-9244

iPhone, iPad and iPod touch are trademarks of Apple Inc.

Android is a trademark of Google Inc.

The Bluetooth® word mark and logos are registered trademarks owned by the Bluetooth SIG, Inc. and any use of such marks by Horizon

Brands is under license. Other trademarks and trade names are those of their respective owners.

TYPE S

LIMITED WARRANTY

TYPE S warrants, to the original purchaser, that its products are free from defects in material and workmanship for 1 year from the date of original purchase. Where permitted by law, TYPE S liability shall be limited to that set forth in this limited express warranty. This limited express warranty shall be the exclusive remedy of the purchaser and TYPE S makes no other warranty of any kind aside from the limited express warranty stated above.

Note: Warranty only applies for North American customers of purchases made in North America.

CONDITIONS OF WARRANTY

If during the 1 year warranty period your new product is found to be defective, TYPE S will repair such defect, or replace the product, without charge for parts or labor subject to the following conditions:

1. All repairs must be performed by TYPE S.
2. All warranty claims must be accompanied by a copy of the sales receipt or bill of sale.
3. The equipment must not have been altered or damaged through negligence, accident, improper operation, or failure to follow the product instructions for installation, use, or care.
4. The replacement of parts is excluded from the warranty when replacement is necessary due to normal wear and tear.
5. Repair or replacement parts supplied by TYPE S under this warranty are protected only for the unexpired portion of the original warranty.
6. This is a “repair or replace” warranty only, and does not cover the costs incurred for the installation, removal or reinstallation of the product, or damage to any mobile phone device or vehicle.

WARRANTY

OWNER'S RESPONSIBILITIES:

TYPE S will make every effort to provide warranty service within a reasonable period of time. SHOULD YOU HAVE ANY QUESTIONS ABOUT SERVICE RECEIVED OR IF YOU WOULD LIKE ASSISTANCE IN OBTAINING SERVICE, PLEASE CALL TOLL FREE 1.866.294.9244 DURING REGULAR BUSINESS HOURS MONDAY THROUGH FRIDAY 8:00 AM TO 5:00 PM.

Note: Toll Free # is for North America Customers ONLY. See Customer service section for customer contact numbers for other regions/offices.

For customer service and technical support, please call us at 1.866.294.9244. If at that time it is determined that a replacement unit is needed, the support representative will issue a Return Authorization and instruct on how to get a new unit. TYPE S makes no other warranty of any kind aside from the limited express warranty stated herein.

DISCLAIMER OF WARRANTIES, INCLUDING WARRANTY OF MERCHANTABILITY AND WARRANTY OF FITNESS FOR PARTICULAR PURPOSE: EXCEPT AS SPECIFICALLY SET FORTH HEREIN, NO WARRANTY OR REPRESENTATION, EXPRESS OR IMPLIED, IS MADE AS TO THE LED VIDEO LIGHT. EXCEPT AS EXPRESSLY SET FORTH HEREIN, TYPE S AND/OR ITS AFFILIATES EXPRESSLY DISCLAIMS, WITHOUT LIMITATION, ANY STATUTORY WARRANTIES AND ALL IMPLIED WARRANTIES, INCLUDING ANY IMPLIED WARRANTY OF MERCHANTABILITY OR FITNESS FOR A PARTICULAR PURPOSE.

WARRANTY

TYPE S and/or its affiliates do not guarantee or promise that the user of LED VIDEO LIGHT will not be in an accident or otherwise not collide with an object and/or person. Our LED VIDEO LIGHT is not intended in any way to be a substitute for careful and cautious driving or for the consistent adherence to all applicable traffic laws and motor vehicle safety regulations.

The LED VIDEO LIGHT is not intended to be a substitute for rearview mirrors or for any other motor vehicle equipment mandated by law. Even when properly installed, our LED VIDEO LIGHT has a limited field of vision and does not provide a comprehensive view of the rear area of the vehicle.

TYPE S and/or its affiliates are not responsible for a user's intended or actual use of the LED VIDEO LIGHT. In no event shall TYPE S and/or its affiliates have any liability for any losses (whether direct or indirect, in contract, tort or otherwise) incurred in connection with the LED VIDEO LIGHT, including but not limited to damaged property, personal injury and/or loss of life. Neither shall TYPE S and/or its affiliates have any liability for any decision, action or inaction taken by any person in reliance on the LED VIDEO LIGHT, or for any delays, inaccuracies and /or errors in connection with the LED VIDEO LIGHT and its functioning.

TYPE S and/or its affiliates shall have no responsibility or liability for damage and/or injury resulting from accidents occurring with vehicles having the installed, and TYPE S and/or its affiliates, the manufacturer, distributor and seller shall not be liable for any injury, loss or damage, incidental or consequential, arising out of the use or intended use of the product.



A Horizon Brands Company

2975 Red Hill Ave., Ste. 100, Costa Mesa,
CA 92626, U.S.A.

1.866.294.9244 | info@typesauto.com

©2022 TYPE S. All rights reserved.

www.typesauto.com