

TOURING ITEMS
TYPES[®]

SOLAR-POWERED HD BACKUP CAMERA WITH BUILT-IN PARKING SENSOR

6" HD Dashboard Monitor Included

WP ITM. BT532858
Care & Use Instructions



**Important, retain for future reference:
Read carefully**

BC

TABLE OF CONTENTS

- 1. Introduction3
- 2. Package Contents4
- 3. Product Specifications5
- 4. Before You Install.....6
- 5. Installation Guide6
- 6. Parking Sensor Coverage12
- 7. Settings & Operation13
- 8. Safety Information19
- 9. Maintenance & Warranty22
- 10. General Information25

1. INTRODUCTION

Please read all of the installation instructions carefully before installing the product. Improper installation will void the manufacturer's warranty. The installation instructions does not apply to all types of vehicles, and are written as guidelines to assist in installing the system.













Consult an experienced technician if you are not comfortable installing the product. You can also contact TYPE S at **866.294.9244** to speak to one of our installation specialists if you have any specific questions regarding the Backup Camera.

BEFORE using the Solar-Powered HD Backup Camera with Built-In Parking Sensor, please read the safety information provided in this user manual. ALWAYS use the product as outlined in this user manual.

Please make sure to read and understand all local laws and regulations regarding cameras and their use in a vehicle. Laws vary by state.

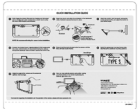
2. PACKAGE CONTENTS

- a. 6" Motion Activated HD Monitor
- b. Solar Powered Parking Sensor Backup Camera
- c. 12V / 24V Power Adapter
- d. 250V 2A Spare Fuse
- e. Windshield Mount
- f. 33" Micro-USB Charging Cable
- g. 2 x License Plate Machine Screw (Optional)
2 x License Plate Self-Tapping Screw (Optional)
- h. 2 x Two-Way Mounting Tab (Optional)
- i. 2 x Mounting Screw & Nut (Optional)
- j. Dash Mount with 3M VHB™ Double Sided Tape
- k. Instruction Manual
- l. Quick Install Guide
- m. Warranty Card

a. 	h. 
b. 	i. 
c. 	j. 
d. 	k. 
e. 	l. 
f. 	m. 
g. 	

3. PRODUCT SPECIFICATIONS

Frequency:	2.4GHz
Operating Voltage:	Monitor - DC 12V/24V, Backup Camera - DC 5V
Operating Temperature:	14°F~122°F (-10°C~50°C)
Camera Water Resistance:	IP65 Rating
Battery Capacity:	5200mAh (Minimum Capacity 5000mAh)
Maximum Signal Range:	33 Feet / 10 Meters (without interference or obstruction)

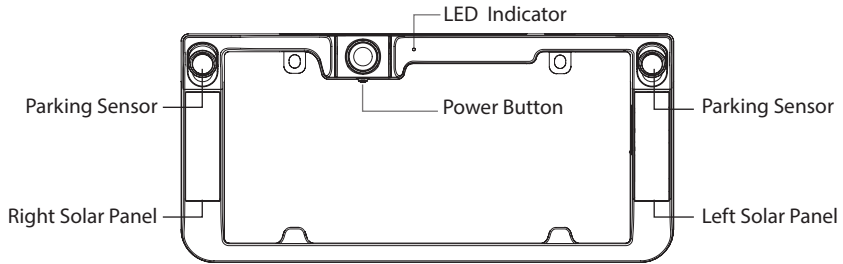

HD Solar-Powered Parking Sensor Backup Camera

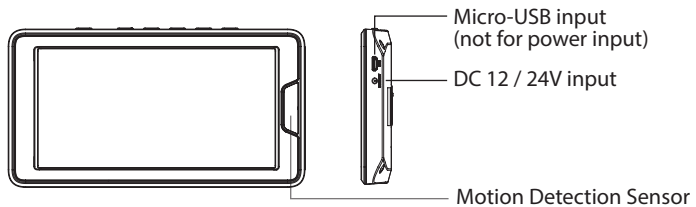

6" Motion Activated HD Monitor

4. BEFORE YOU INSTALL

1. Fully charge the camera: Flip open the charging port lid located next to the left solar panel. Connect it to a power source using the Micro-USB charging cable included.
2. Connect the monitor to power, turn on the camera, and test the connection. (Camera comes pre-paired to the monitor)

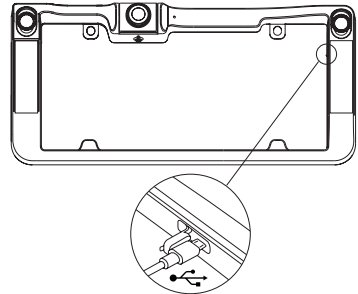

5. INSTALLATION GUIDE

MONITOR INSTALLATION - DASHBOARD MOUNT

1.

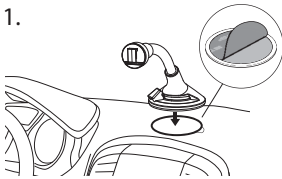

2.

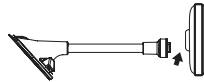

1. Peel off the 3M VHB™ double-sided tape on the Dash Mount and attach the mount onto your dashboard.
2. Attach the monitor onto the Windshield Mount, remove the screen protection film, and adjust it to your desired angle.

NOTE: We recommend placing the bottom of the monitor on the dashboard so the dashboard can help support its weight.

MONITOR INSTALLATION - WINDSHIELD MOUNT

1.

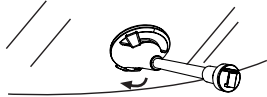

2.

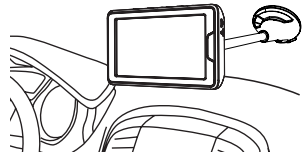
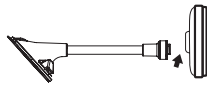

1. Attach the Windshield Mount onto the windshield. Utilize the lever to secure the mount in place.
2. Attach the monitor onto the Windshield Mount, remove the screen protection film, and adjust the monitor to your desired angle.

NOTE: We recommend placing the bottom of the monitor on the dashboard so the dashboard can help support its weight.

POWER UP THE DASH MONITOR

Connect the monitor to your 12/24V outlet (cigarette lighter) using the power cable included. We recommend having the cable go through the passenger side so it doesn't get into the driver's way.

WARNING: Some vehicles continue providing power through 12V/24V outlet even when turned off. If that's the case, please unplug the monitor when it's not in use to avoid draining the battery.

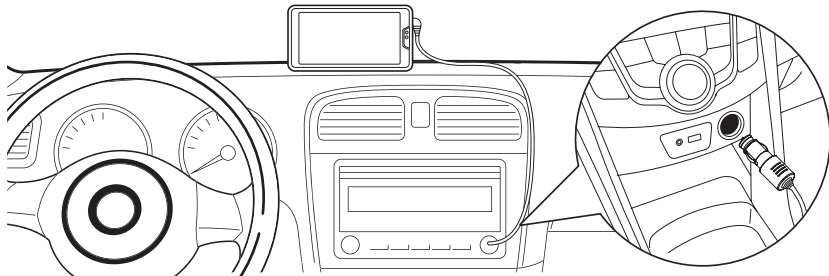

BACKUP CAMERA INSTALLATION

A) STANDARD INSTALLATION:

1. Install the Backup Camera over your rear license plate.

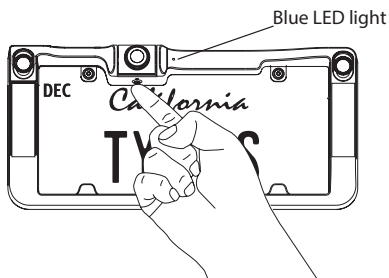

2. Press and hold the button located under the camera until the Blue LED light double flashes.

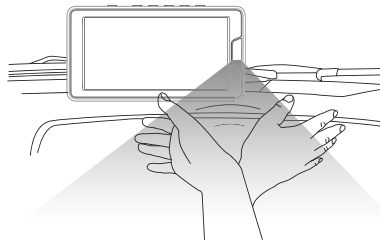

3. Now you may wake the camera up by either waving your hand in front of the monitor or by pressing the  **wake-up** button once.

*For safety measures, please remember to check your surroundings when backing up; do not rely solely on the backup camera.

B) LOWERED INSTALLATION – USE THIS OPTION IF THE STANDARD INSTALLATION BLOCKS THE TRUNK/HATCHBACK RELEASE BUTTON

1. Unscrew and detach the existing mounting tabs from the camera.

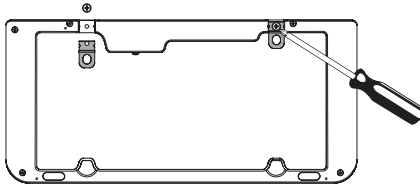

2. Install the Two-Way Mounting Tabs (included) onto the camera.

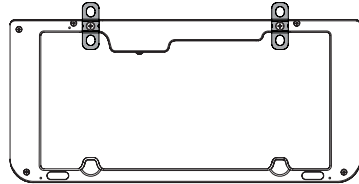

3. Remove the license plate from your vehicle and attach it onto the backup camera using the mounting screw set (i).

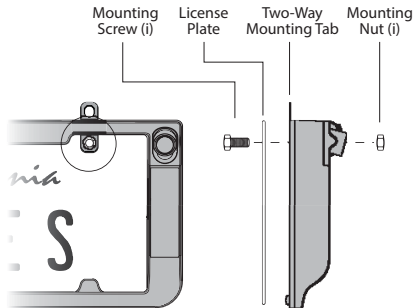

4. Install the backup camera and your license plate back onto your vehicle.

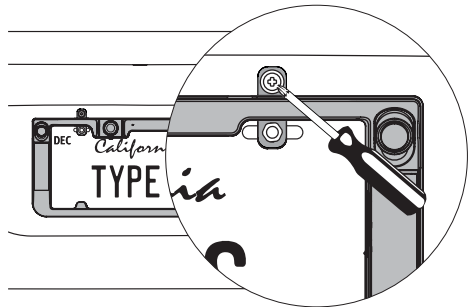

C) RAISED INSTALLATION – FOR TRUCKS & SUV WITH STEP BUMPERS

1. Remove the license plate from your vehicle.



2. Install the Two-Way Mounting Tab onto the drill holes.

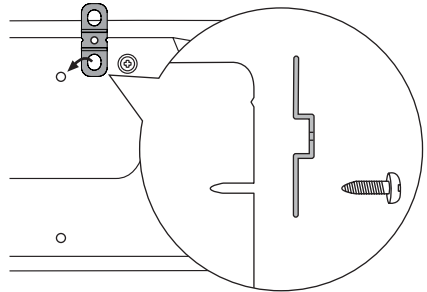

3. Install the backup camera and your license plate back onto your vehicle.

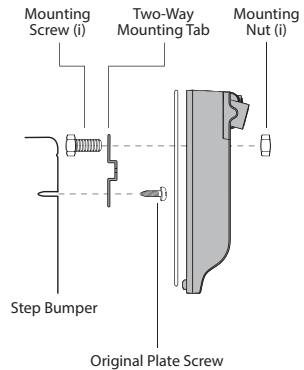
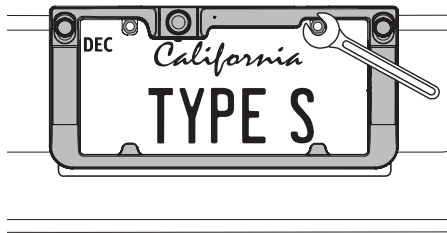

ADJUSTING CAMERA LENS AND PARKING SENSOR ANGLE

Adjust the angle of the camera and the sensors to optimize their coverage.

1 Parking Sensor coverage

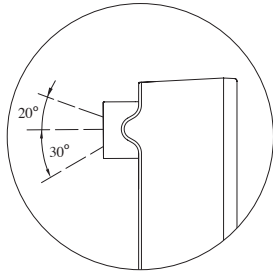

2 Backup Camera viewing angle

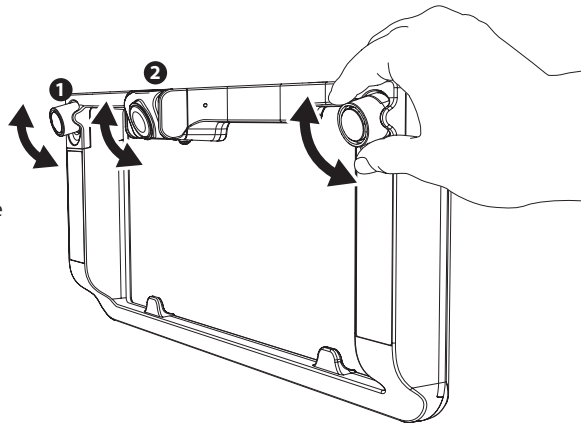
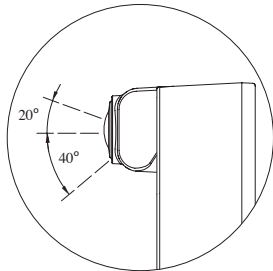

6. PARKING SENSOR COVERAGE

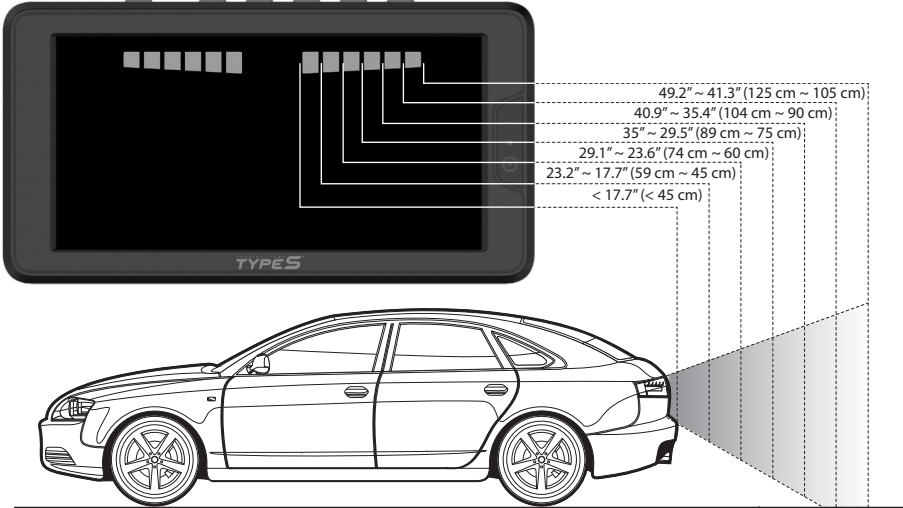

7. SETTINGS & OPERATION



BUTTON CONTROLS

1. / Wake-up / Screen mode
2. / Down
3. / Menu
4. / Power / Back
5. / Parking Aid Grid / Confirm
6. / Up / Sound Alert On/Off

SPLIT SCREEN

Add an extra camera (BT534021, sold separately) and view both front and back in split screen mode. The button can be used to switch between different screen modes once the additional cam has been set up.





BATTERY INDICATOR

The battery indicator shows the battery level of the Backup Camera.

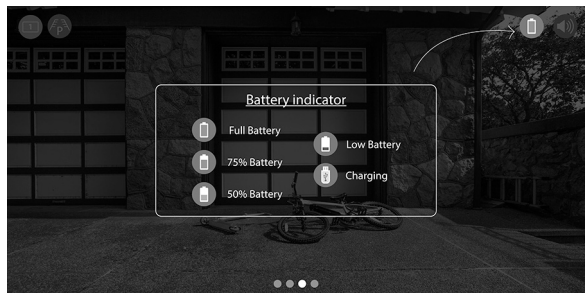
NOTE: Fully charge and test the camera before installation.



PARKING AID GRID

The  button can be used to turn the Parking Aid Grid on/off. The same button can also be used to adjust the line: Press & hold the  button for 3 seconds until the line starts flashing, utilize the + and — buttons to move the line up/down. Once you're done, press  again to confirm.





NOTE: Parking Aid Grid adjustment only available during single camera mode.

PAIRING

The camera is pre-paired to the monitor. Below is the screen that you should be seeing upon powering on the monitor.



In case the image isn't showing up properly, please follow the steps below to pair the camera.

1. Press & hold the power button under the camera for 6 seconds until the LED starts flashing BLUE continuously.
2. On the monitor, press  to enter the  **Settings** page. Press + or — to navigate to the  **Pair Camera** screen.
3. Press + or — to choose **Front Camera** or **Rear Camera** - **Click to pair** and press  to start pairing.

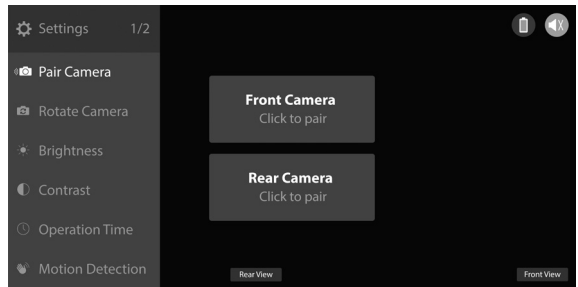
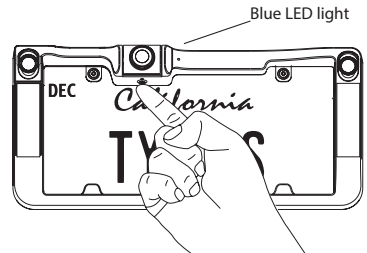

- Once the camera has been successfully paired, the display will show “Pair OK”
- In case the display shows “Pair Fail”, please restart the monitor and try again. If you still can’t get it to work after multiple tries, please contact our technical support for further assistance.

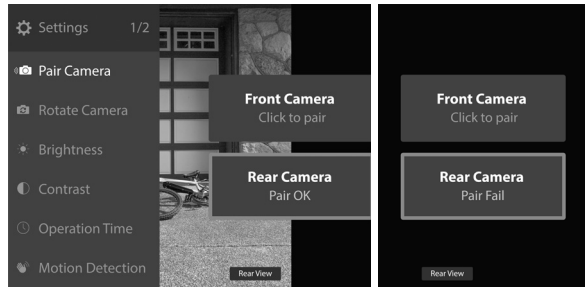

MONITOR SETTINGS

Press to open up the **Settings** tab on the left of the screen. Press or to navigate to each individual setting screen and press to begin. Once the change is made press to return to live view.

NOTE: Settings can only be changed in single camera mode.

ROTATE CAMERA

Press and to reverse camera view and press to confirm.

BRIGHTNESS

Press and to adjust screen brightness and press to confirm.

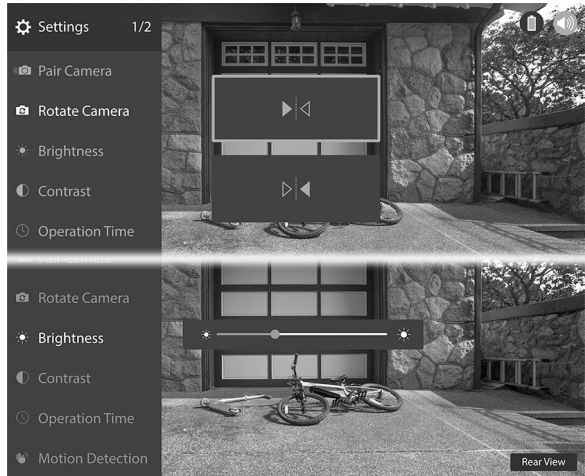

CONTRAST

Press **+** and **-** to adjust screen contrast and press **[Enter]** to confirm.

OPERATION TIME

Press **+** and **-** to adjust different operation time. Press **[Enter]** to confirm. The "operation time" refers to how long the monitor will stay on each time you wake it up before returning into stand-by mode .

MOTION DETECTION

Press **+** or **-** to choose motion detection range. Press **[Enter]** to confirm. Motion detection range can help you adjust the detection distance between you and the monitor when you drive. You can also disable the function by turning it off.

DEFAULT SETTINGS

Press **+** to switch between **OK** or **Cancel**. Press **[Enter]** to confirm. Once confirmed all settings will be reset to their defaults.

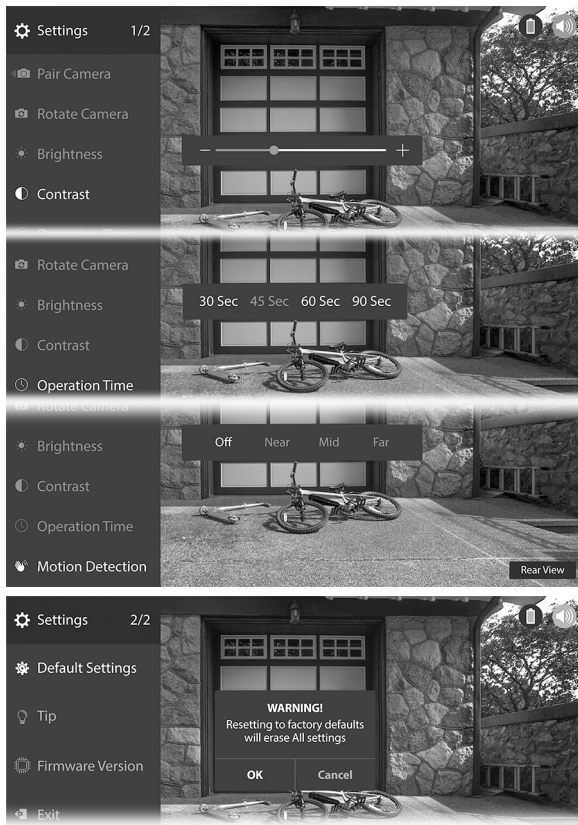

🔊 SOUND ALERT

Press **+** to turn the parking sensor sound alert On/Off.

💡 TIPS

Press **+** or **-** to read through the on-screen instructions. Press **⏪** to return to live view.

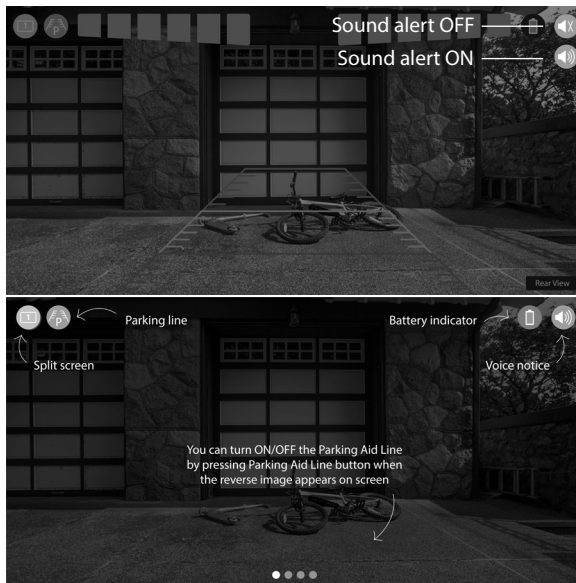

BACKUP CAMERA POWER, MODES & LED INDICATORS	
Power / Mode Status	LED Indicators
Power On Press and hold Power button for 1 second, Camera will power on.	Blue LED light flashes 2 times when Camera is powered on.
Power Off Press and hold Power button for 2 seconds and release, Camera will power off.	Red LED light flashes 1 time when the Camera is powered off.
Pairing Mode To begin Pairing Mode, press the Power button on Camera until blue LED light flashes quickly. Now Camera is in Pairing Mode.	Blue LED light flashes quickly for 1 minute or until pairing success is complete.
Low Battery Power Off Camera will power off when the battery is used up.	Red LED light flashes to indicate low battery.
USB Charging This LED light is next to the Micro-USB port.	While charging, the Red LED light will remain solid. When Camera is fully charged, Red LED light turns off.

MONITOR INDICATOR

If this message appears on the monitor, the battery for the camera is low and needs to be charged. To charge the camera, please connect it to a power source using the charging cable included.

Your backup camera is currently off. Fully charge camera overnight.
Review User Manual or visit typesauto.com for charging instructions.

8. SAFETY INFORMATION

IMPORTANT SAFETY INSTRUCTIONS

1. SAVE THESE INSTRUCTIONS– This manual contains important safety and operating instructions of car charger for Model BT532858.
2. Before using the product, read all instructions and cautionary markings.
3. Do not expose car charger to rain, moisture, or snow.
4. Use of an attachment not recommended or sold by the product manufacturer may result in a risk of fire, electric shock, or injury to persons.
5. To reduce risk of damage to cigarette lighter connector and cord, pull by cigarette lighter connector rather than cord when disconnecting car charger.
6. Make sure cord is located so that it will not be stepped on, tripped over, or otherwise subjected to damage or stress.
7. Do not operate car charger with damaged cord or cigarette lighter connector – replace it immediately.
8. Do not operate car charger if it has received a sharp blow, been dropped, or otherwise damaged in any way; take it to a qualified serviceperson.
9. Do not disassemble car charger; take it to a qualified serviceperson when service or repair is required. Incorrect reassembly may result in a risk of electric shock or fire.
10. To reduce risk of electric shock, unplug charger before attempting any maintenance or cleaning. Turning off controls will not reduce this risk.

WARNING: A failure to read and follow these warnings and instructions may result in a serious accident, including damaged property or a serious injury, including loss of life.

- The Backup Camera is designed as an aid to the driver in detecting large stationary objects to help avoid damaging the vehicle. However, you, the driver, must use it safely and properly. Use of the Backup Camera is not a substitute for safe, proper and legal driving.
- Never back up while looking only at the screen. You should always check behind and around the vehicle when backing up just as you would if the vehicle did not have the Backup Camera. Always make sure your intended path is clear. If you back up while looking only at the Monitor, you may hit a vehicle, pedestrian, bicyclist, child, pet or other object resulting in injury or death. Always back up slowly.
- Never depend on the Backup Camera entirely when backing up. The image on the screen is

different from actual conditions. Objects viewed in the monitor differ from actual distance because a wide-angle lens is used. Objects in the monitor will appear visually opposite than when viewed in the rear view and outside mirrors. Use the inside mirror or glance over your shoulder to properly judge distances to other objects.

- The Backup Camera “night vision” feature that is high performance brightness with colorful image is an aid to a driver but is limited. Always use your own eyes to confirm the vehicle’s surroundings, as the displayed image may be faint or dark, distorted, or not entirely visible. Always check behind and all around the vehicle visually with mirrors before proceeding.
- The area displayed by the Backup Camera is limited. The Backup Camera does not display objects that are close to or below the bumper, underneath the vehicle, or objects out of the Camera’s field of view. The area displayed on the screen may vary according to vehicle orientation or road conditions.
- Be sure to check the Camera’s position and mounting angle before each use.
- Make sure the trunk, hatch, or backdoor is completely and securely closed when backing up.
- If the back of the vehicle is hit, the position and mounting angle of the Backup Camera may change.
- When washing the vehicle with high pressure water, be sure not to spray it around the Backup Camera. Otherwise, water may enter the Camera unit causing water condensation on the lens, a malfunction, fire or an electric shock.
- Do not strike the Backup Camera. It is a precision instrument. Otherwise, it may malfunction or cause damage resulting in a fire or an electric shock.
- This product will only provide images of items that are within the field of view of the Backup Camera. Thus, it is imperative that the Backup Camera should be kept clean and unobstructed, and should be mounted so that its field of view includes the entire area behind your vehicle.
- Adhere to all applicable traffic laws and motor vehicle regulations applicable to the device.
- Consult local laws and regulations for any restrictions on installation or use.
- Never allow children to play with the device. Small parts may be a choking hazard.
- There is a plastic cover over the Backup Camera. Do not scratch the cover when cleaning dirt or snow from the cover.
- The Backup Camera has a water resistant construction. Do not detach, disassemble or modify it. This may cause incorrect operation. Backup Camera is waterproof.

- Do not submerge Backup Camera in water, which can cause internal damage to the Camera.
- If the temperature changes rapidly, such as when hot water is poured on the vehicle in cold weather, the system may not operate normally. The Digital Camera can withstand the effects of rain, snow, and inclement weather.
- When strong light directly enters a camera, objects may not be displayed clearly.
- The screen may flicker under fluorescent light.
- The colors of objects on the monitor may differ somewhat from those of the actual object.
- If dirt, rain or snow attaches to the Camera, the Monitor may not clearly display objects. If water droplets, snow or mud adhere to the Camera lens, rinse with water and wipe with a dry cloth.
- Do not use alcohol or thinner to clean the Camera. This will cause discoloration. To clean the Camera, wipe with a clean cloth dampened with mild cleaner diluted with water and then wipe with a dry cloth.
- Monitor and Camera will remain connected up to 33 feet without any obstacles or interference.
- ALWAYS engage Parking/Emergency/Hand Brakes of the vehicle when testing the system.

SAFETY AROUND AND BEHIND OTHER VEHICLES

Using a Backup Camera is not enough to completely overcome a vehicle's blind spot. Many preventable injuries and deaths occur in driveways or parking lots when drivers do not see children, pets, or others near their vehicles. Here are a few safety tips that will help you to avoid a back-over accident:

- Walk completely around your vehicle before getting in. Check for kids, toys, and pets before entering the vehicle and starting the engine.
- Know where children are. Have children stand in a place where they are in full view.
- Be aware of young children. Young children are small and hard to see.
- Parents, caregivers and all adults need to be vigilant in supervising children, especially when children are in the yard, driveway or parking lot playing near parked cars.
- Roll down your window so you will be able to hear what is happening outside your vehicle.
- Owners of SUVs, trucks, and vans need to take extra care to avoid hitting or running over a child.
- Teach children to move away from a vehicle whenever it is started.

9. MAINTENANCE & WARRANTY

CLEANING

- If dirt, rain or snow attaches to the Camera, the Monitor may not clearly display objects. If water droplets, snow or mud adhere to the Camera lens, rinse with water and wipe with a dry cloth.
- Do not use alcohol, benzene or thinner to clean the Camera. This will cause discoloration. To clean the Camera, wipe with a clean cloth dampened with mild cleaner diluted with water and then wipe with a dry cloth.

WARRANTY

- **TYPE S
LIMITED WARRANTY**

TYPE S warrants, to the original purchaser, that its products are free from defects in material and workmanship for 1 year from the date of original purchase. Where permitted by law, TYPE S's liability shall be limited to that set forth in this limited express warranty. This limited express warranty shall be the exclusive remedy of the purchaser and TYPE S makes no other warranty of any kind aside from the limited express warranty stated above.

NOTE: Warranty only applies for North American customers of purchases made in North America.

CONDITIONS OF WARRANTY

If during the 1 year warranty period your new product is found to be defective, TYPE S will repair such defect, or replace the product, without charge for parts or labor subject to the following conditions:

1. All repairs must be performed by TYPE S.
2. All warranty claims must be accompanied by a copy of the sales receipt or bill of sale.
3. The equipment must not have been altered or damaged through negligence, accident, improper operation, or failure to follow the product instructions for installation, use, or care.
4. The replacement of parts is excluded from the warranty when replacement is necessary due to normal wear and tear.

5. Repair or replacement parts supplied by TYPE S under this warranty are protected only for the unexpired portion of the original warranty.
6. This is a “repair or replace” warranty only, and does not cover the costs incurred for the installation, removal or reinstallation of the product, or damage to any mobile phone device or vehicle.

OWNER’S RESPONSIBILITIES:

TYPE S will make every effort to provide warranty service within a reasonable period of time. SHOULD YOU HAVE ANY QUESTIONS ABOUT SERVICE RECEIVED OR IF YOU WOULD LIKE ASSISTANCE IN OBTAINING SERVICE, PLEASE CALL TOLL FREE 1.866.294.9244 DURING REGULAR BUSINESS HOURS MONDAY THROUGH FRIDAY 8:00 AM TO 5:00PM.

NOTE: Toll Free # is for North America Customers ONLY. See Customer service section for customer contact numbers for other regions/offices.

For customer service and technical support, please call us at 1.866.294.9244. If at that time it is determined that a replacement unit is needed, the support representative will issue a Return Authorization and instruct on how to get a new unit.

TYPE S makes no other warranty of any kind aside from the limited express warranty stated herein.

DISCLAIMER OF WARRANTIES, INCLUDING WARRANTY OF MERCHANTABILITY AND WARRANTY OF FITNESS FOR PARTICULAR PURPOSE: EXCEPT AS SPECIFICALLY SET FORTH HEREIN, NO WARRANTY OR REPRESENTATION, EXPRESS OR IMPLIED, IS MADE AS TO THE BACKUP CAMERA. EXCEPT AS EXPRESSLY SET FORTH HEREIN, TYPE S AND/OR ITS AFFILIATES EXPRESSLY DISCLAIMS, WITHOUT LIMITATION, ANY STATUTORY WARRANTIES AND ALL IMPLIED WARRANTIES, INCLUDING ANY IMPLIED WARRANTY OF MERCHANTABILITY OR FITNESS FOR A PARTICULAR PURPOSE.

TYPE S and/or its affiliates do not guarantee or promise that the user of Backup Camera will not

be in an accident or otherwise not collide with an object and/or person. Our Backup Camera is not intended in any way to be a substitute for careful and cautious driving or for the consistent adherence to all applicable traffic laws and motor vehicle safety regulations.

The Backup Camera is not intended to be a substitute for rearview mirrors or for any other motor vehicle equipment mandated by law. Even when properly installed, our Backup Camera has a limited field of vision and does not provide a comprehensive view of the rear area of the vehicle. You should always look around outside your vehicle and use your mirrors to confirm rearward clearance and that your vehicle can back up safely.

TYPE S and/or its affiliates are not responsible for a user's intended or actual use of the Backup Camera. In no event shall TYPE S and/or its affiliates have any liability for any losses (whether direct or indirect, in contract, tort or otherwise) incurred in connection with the Backup Camera, including but not limited to damaged property, personal injury and/or loss of life. Neither shall TYPE S and/or its affiliates have any liability for any decision, action or inaction taken by any person in reliance on the Backup Camera, or for any delays, inaccuracies and /or errors in connection with the Backup Camera and its functioning.

TYPE S and/or its affiliates shall have no responsibility or liability for damage and/or injury resulting from accidents occurring with vehicles having the installed, and TYPE S and/or its affiliates, the manufacturer, distributor and seller shall not be liable for any injury, loss or damage, incidental or consequential, arising out of the use or intended use of the product.

10. GENERAL INFORMATION

CUSTOMER SERVICE/CONTACT

IF YOU ARE EXPERIENCING ANY ISSUES WITH THE PRODUCT DURING OPERATION, DO NOT RETURN THE PRODUCT TO THE STORE. CONTACT TYPE S DIRECTLY FOR INSTRUCTIONS ON HOW TO RETURN/ EXCHANGE THE PRODUCT.

FCC Compliance Statement:

This device complies with Part 15 of the FCC rules. Operation is subject to the following two conditions: (1) This device may not cause harmful interference, and (2) this device must accept any interference received, including interference that may cause undesired operation.

Warning: Changes or modifications to this unit not expressly approved by the party responsible for compliance could void the user's authority to operate the equipment. The manufacturer is not responsible for any radio or TV interference caused by unauthorized modifications or change to this equipment. Such modifications or change could void the user's authority to operate the equipment.

Note: This equipment has been tested and found to comply with the limits for a Class B digital device, pursuant to part 15 of the FCC Rules. These limits are designed to provide reasonable protection against harmful interference in a residential installation. This equipment generates, uses and can radiate radio frequency energy and, if not installed and used in accordance with the instructions, may cause harmful interference to radio communications. However, there is no guarantee that interference will not occur in a particular installation. If this equipment does cause harmful interference to radio or television reception, which can be determined by turning the equipment off and on, the user is encouraged to try to correct the interference by one or more of the following measures:

- Reorient or relocate the receiving antenna.
- Increase the separation between the equipment and the receiver.
- Connect the equipment into an outlet on a circuit different from that to which the receiver is connected.
- Consult the dealer or an experienced radio/TV technician for help.

This equipment complies with FCC RF radiation exposure limits set forth for an uncontrolled environment. In order to avoid the possibility of exceeding the FCC radio frequency exposure limits, human proximity to the antenna shall not be less than 20cm during normal operation.

Solar-Powered HD Backup Camera with Built-In Parking Sensor

6" HD Dashboard Monitor Included

BT532858

Responsible Party:

TYPE S

2975 Red Hill Ave., Ste. 100,

Costa Mesa, CA 92626, U.S.A.

Tel: 1-866-294-9244

3M VHB™ is a trademark of 3M Company.

REGISTRATION
TYPES

A Horizon Brands Company
2975 Red Hill Ave., Ste. 100, Costa Mesa, CA 92626, U.S.A.
1.866.294.9244 | info@typesauto.com
©2023 TYPE S. All rights reserved.

www.typesauto.com

ML-532858_V1