

TOURING ITEMS
TYPES[®]

Plug & Glow[™]

Automotive
72" Exterior Smart
Lighting Kit



Exterior Kit can also function
as interior lighting

Instruction Manual

PACKAGE CONTENTS

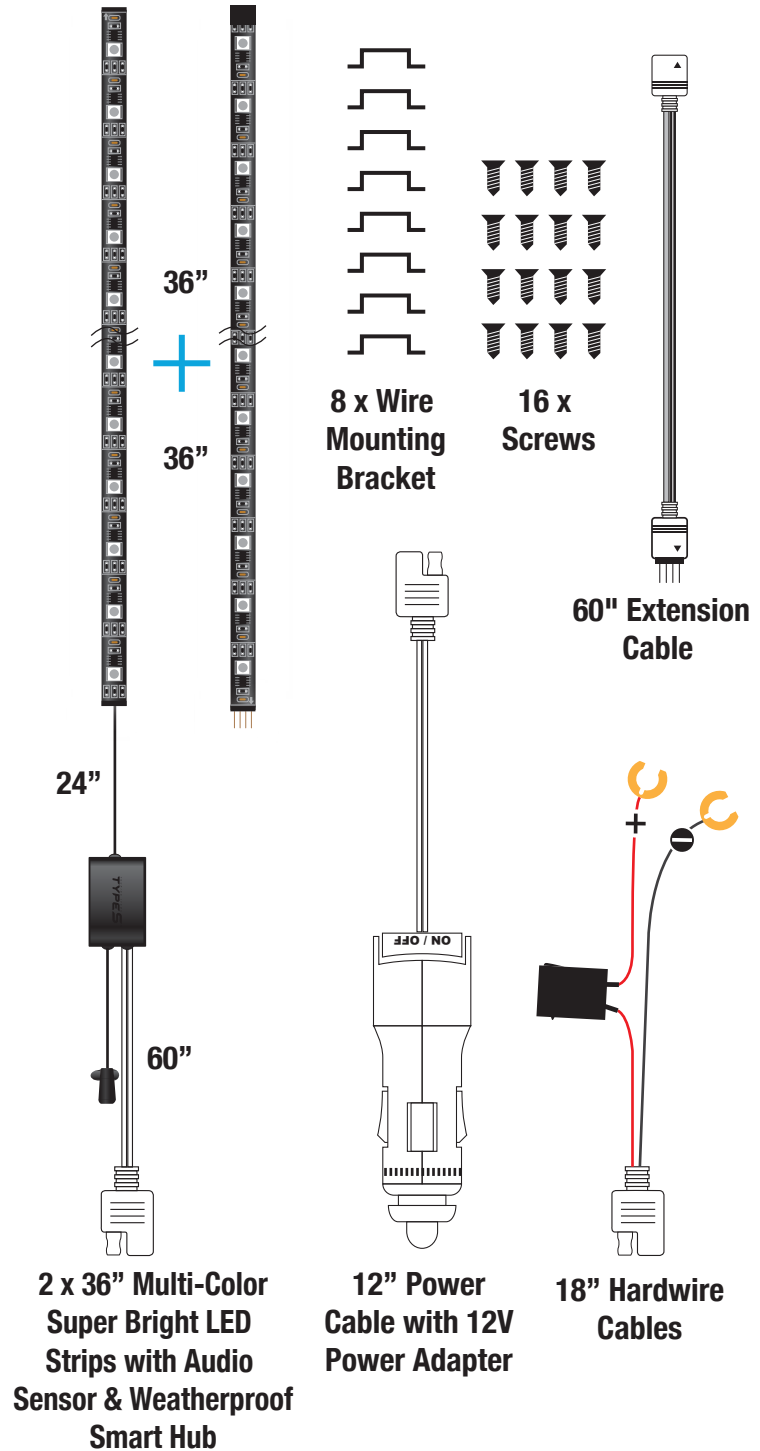

TECHNICAL SPECIFICATIONS

Working voltage: DC 12V Only

Bluetooth distance: 30ft (no obstacle)

Frequency band: 2.4 GHz

Types of LED: 5050 SMD RGB

Maximum amperage draw: 3A

Replacement Fuse: 3A

INSTALLATION

Exterior

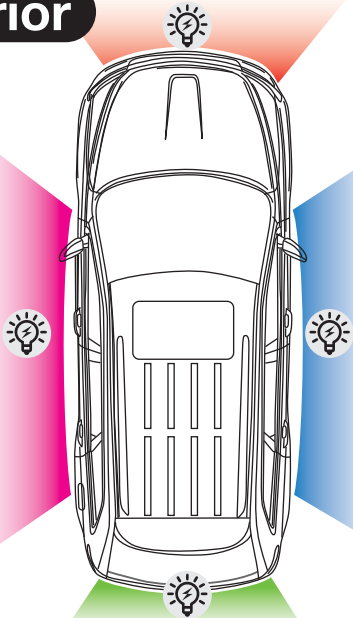

Interior

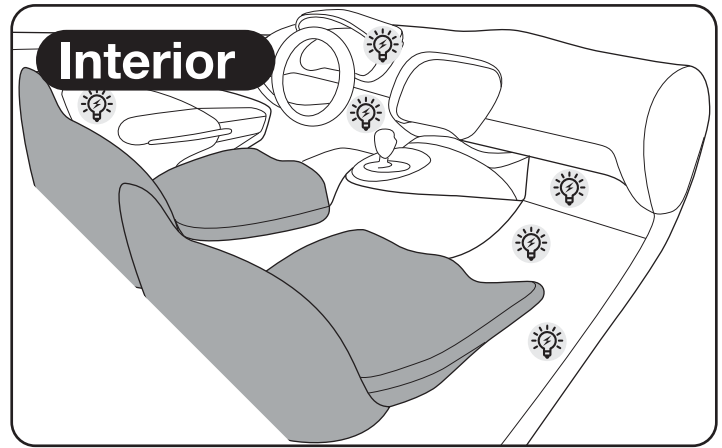

INSTALLING THE LIGHT:

- Choose your desired location.
( – see suggestions as shown)
- Clean surface thoroughly with isopropyl alcohol. Dry completely.
- Peel off the 3M™ tape backer and carefully apply to the desired area.

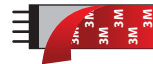

- Use the wire mounting brackets and screws if needed to secure the LED strip or wire as shown below.

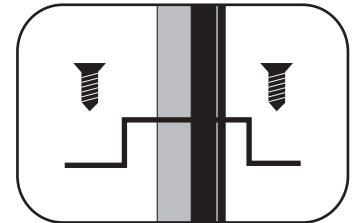
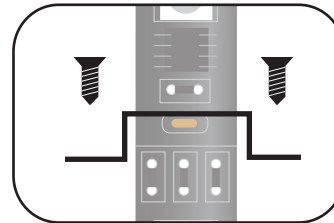

- This kit comes with two 36" LED strips and a 60" extension cable. Match arrows indicated for correct orientation. An incorrect connection will cause lights to malfunction.

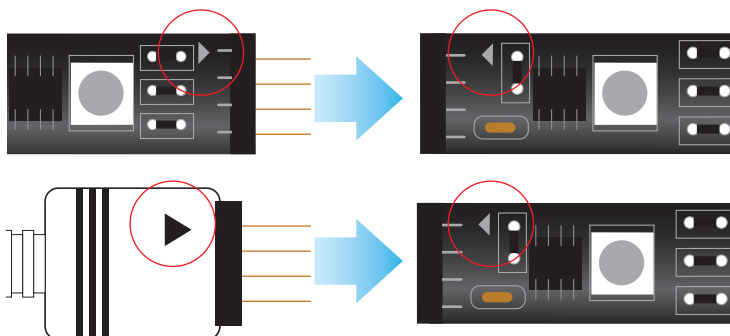

NOTE: If needed, LED strips can be cut every 6 LED chips – ONLY cut where the line marks are shown.

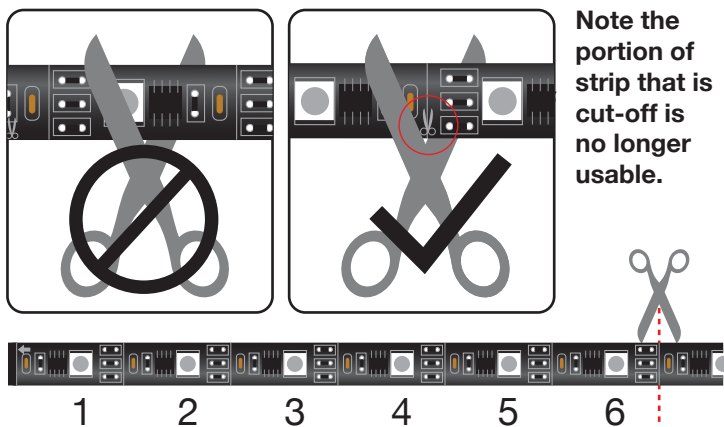

INSTALLING THE AUDIO SENSOR:

Audio sensor is only recommended for interior installation. For external installation, please unplug the audio sensor plug.

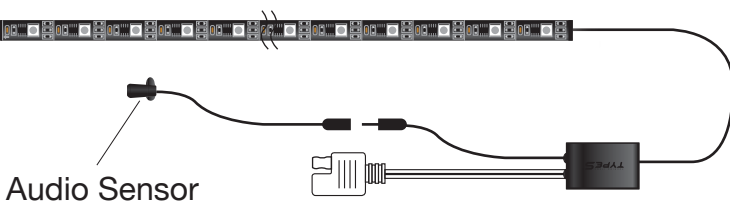

POWER

INSTALLING THE SMART HUB:

- For use with 12V power only
- Choose your desired location for the Smart Hub.
- Clean surface thoroughly with isopropyl alcohol. Dry completely.
- Peel off the 3M™ tape backer at the bottom of the Smart Hub and carefully apply to the desired area.

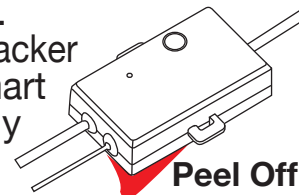

Two Power options available

- Ⓐ 12V Plug-in power adapter (Interior)
- Ⓑ 12V Hardwire (Exterior)

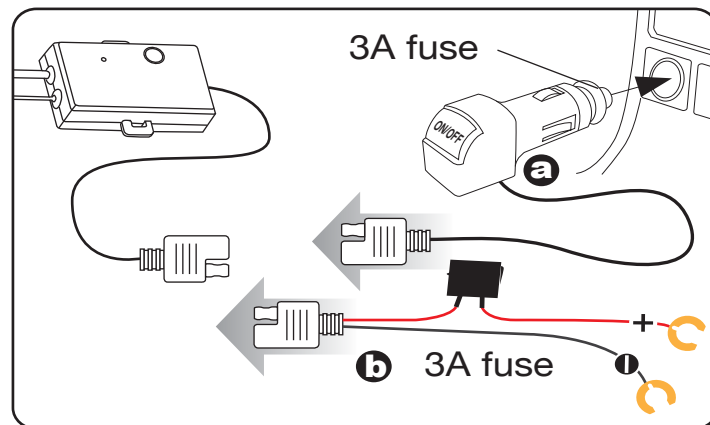

- Select your desired power connection and connect to the Smart Hub two pin connector.
- For exterior installation, we recommend to use Ⓑ 12V Hardwire installation.
- Smart Hub hardwire cables are color coded, **RED** for POSITIVE (+) and **BLACK** for NEGATIVE (-).
- Connect the **RED** cable to the POSITIVE (+) battery clamp as illustrated. The POSITIVE battery post will be slightly larger than the NEGATIVE post, and will be marked with a PLUS (+) sign. There may also be a **RED** protective cover over the positive battery

12V Hardwire installation

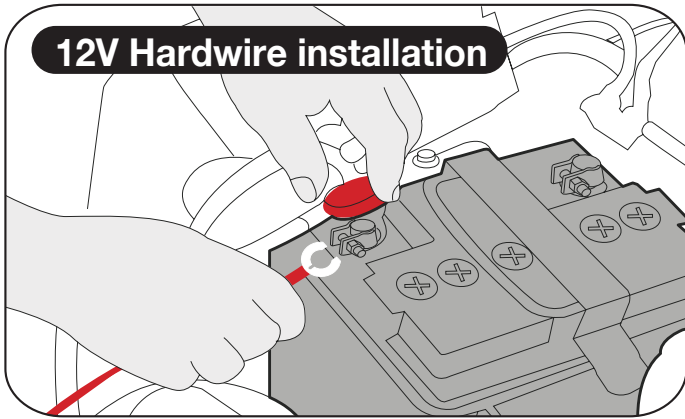

post.

- Connect the **BLACK** cable to the **NEGATIVE (-)** battery clamp as illustrated. The **NEGATIVE** will be marked with a **MINUS (-)** sign. There may also be a **BLACK** plastic protective cover over the negative battery post.

NOTE: After connecting the Smart Hub to the car battery, the LED power indicator will flash Blue. If the LED power indicator does not flash once connected, please recheck your power connections.

The Smart HUB has built-in voltage protection to prevent car battery drain in case the lights are accidentally left on. The lights will automatically turn off and the HUB will be on standby mode when the voltage drops to approximately 12V. Once on standby mode, if the car battery is producing below 12V, do not turn on the LED lights until your next engine start or when power is back to 12V or above.

WARNING: DO NOT mix up the cables or allow the metal ends to touch together because this may damage the battery, charging system and/or electronics on a vehicle. When installing, please make sure your engine is not running.

WARNING

WARNINGS:

1. Do not install or use product if it, in any way, impairs the safe operation of your vehicle.
2. NEVER use the APP while operating your vehicle. Use the APP when vehicle is stationary only.
3. Follow manufacturer's instructions to ensure the product is properly & safely installed.
4. Check your state or provincial laws before installing. Vehicle owner must comply with all applicable laws.
5. This product is intended solely for decorative purposes. Manufacturer and Seller assume no liability for installation or use, which are solely the responsibility of the purchaser.
6. This product is not DOT approved and is designed and intended for off-road use only. Not for use in extreme temperature such as under hood applications.
7. The Manufacturer and Seller are not responsible or liable for consequential, incidental, or indirect damages, whether to person or property, resulting from the installation or improper use of this product.

PROP 65 WARNING: This product contains lead, a chemical known to the state of California to cause cancer, birth defects or other reproductive harm.

Wash hands after handling.

FCC & IC

This device complies with Part 15 of the FCC Rules. Operation is subject to the following two conditions: (1) This device may not cause harmful interference, and (2) This device must accept any interference received, including interference that may cause undesired operation.

The manufacturer is not responsible for any radio or TV interference caused by unauthorized modifications or change to this equipment. Such modifications or change could void the user's authority to operate the equipment.

This equipment has been tested and found to comply with the limits for a Class B digital device, pursuant to Part 15 of the FCC Rules. These limits are designed to provide reasonable protection against harmful interference in a residential installation. This equipment generates, uses and can radiate radio frequency energy, and, if not installed and used in accordance with the instructions, may cause harmful interference to radio communications. However,

there is no guarantee that interference will not occur in a particular installation. If this equipment does cause harmful interference to radio or television reception, which can be determined by turning the equipment off and on, the user is encouraged to try to correct the interference by one of the following measures:

- Reorient or relocate the receiving antenna
- Increase the separation between the equipment and receiver
- Connect the equipment into an outlet on a circuit different from that to which the receiver is connected
- Consult the dealer or an experienced radio/TV technician for help

The device has been evaluated to meet general RF exposure requirement. To maintain compliance with FCC RF exposure guidelines, this equipment should be installed and operated with a minimum distance of 20cm between the radiator and your body.

CAN ICES-3(B) / NMB-3(B)

This radio transmitter (identify the device by certification number or model number if Category II) has been approved by Industry Canada to operate with the antenna types listed below with the maximum permissible gain indicated. Antenna types not included in this list, having a gain greater than the maximum gain indicated for that type, are strictly prohibited for use with this device.

Antenna Type	Max. Antenna Gain (dBi)
PCB printed antenna	0



Have a comment or question?

Email us at: info@winplususa.com

or visit us online at: www.winplususa.com

Winplus North America, Inc.

820 South Wanamaker Avenue, Ontario, CA 91761 USA

Tel: 866-294-9244

© 2016 Winplus North America, Inc.

All rights reserved.

3M™ is a trademark of 3M Company.

Apple, the Apple logo, iPhone, iPad and iPod touch are trademarks of Apple Inc. App Store is a service mark of Apple Inc. Android, Google Play, and the Google Play logo are trademarks of Google Inc.

APP INSTALLATION

- Install the Smart Lighting APP on your device. Search for the APP through the APP Store or Google Play under:



WINPLUS TYPE S LED

- Or scan the QR code below to find the compatible APP for iOS or Android.

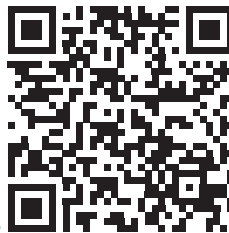

Scan to download APP

Compatible with iPhone 4s & higher, iPad3, iPad Mini, iPad Air & higher, and iPod touch 5th Generation & higher.
Requires iOS 7.0 or higher.

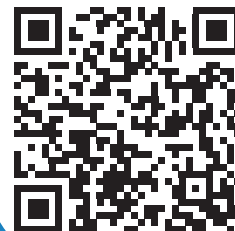

Scan to download APP

Compatible with phones with Android™ 4.3 or higher.

Note: not all Android™ phones are equipped with Bluetooth® Smart v4.0 required for this application.

- Once installed, open the APP and begin enjoying your Plug & Glow™ experience.



USING THE APP

Home Page

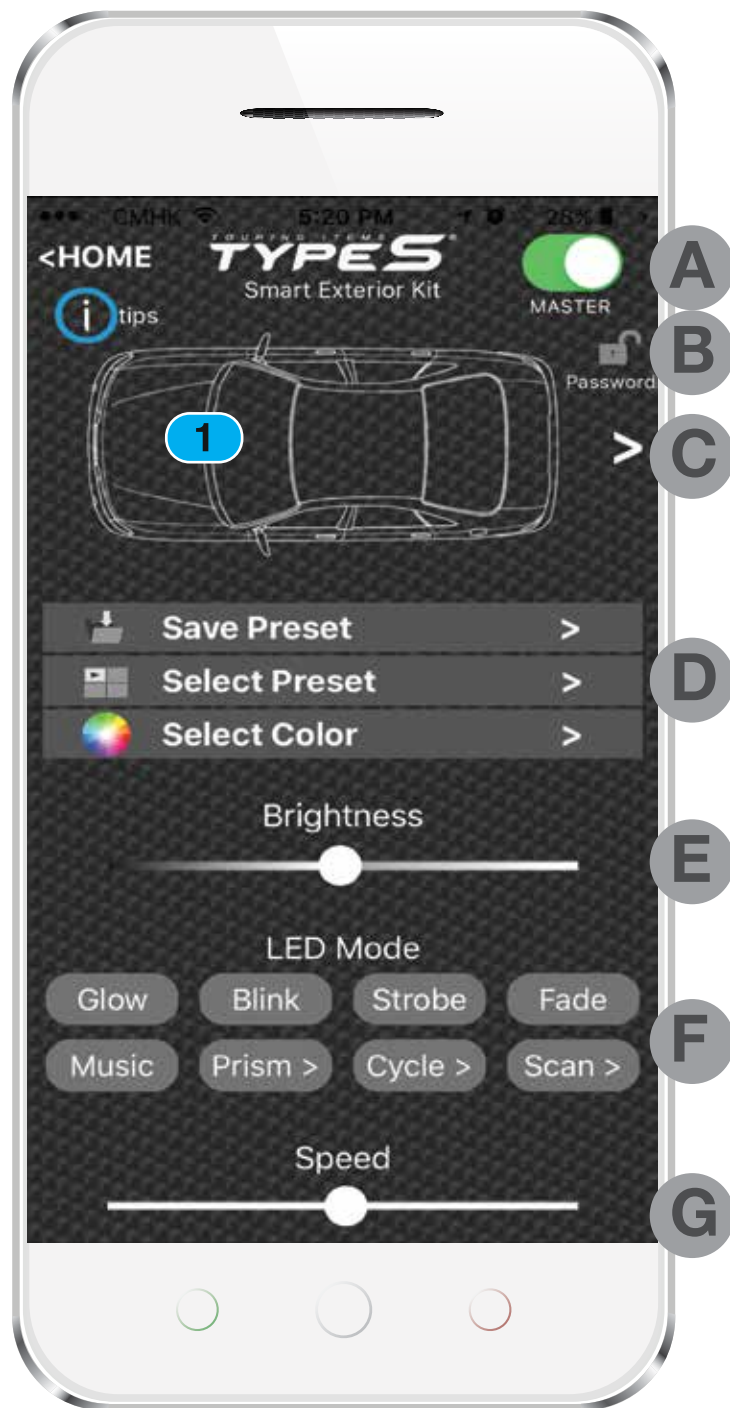

Tap “Smart Exterior Kit” Icon to start

APP will automatically pair to the Hub when both are powered on (including Bluetooth) and within 30ft

A Master On/Off Switch

B Password:

You can set up a password to prevent other devices from controlling your lights. Once you have entered your password, it will be saved in the APP and the Smart Hub Controller.



NOTE: To set or change the password, your device must be connected to the Smart Hub and simply follow on-screen instructions. Changing the password without connecting to the Smart Hub may cause an invalid password the next time your App and Smart Hub are activated. If you forget your password, simply reset by pressing the Smart Hub Controller reset button for 3 seconds or disconnect the power from the car battery.

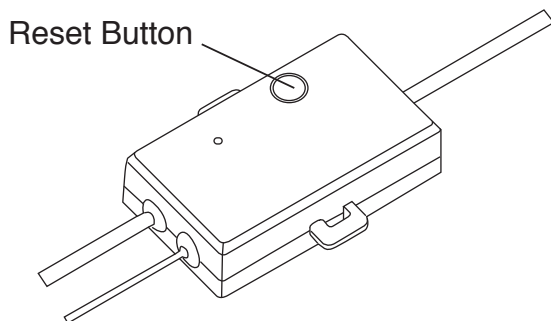

C LED Zone Functions:

1 Connect and control up to four separate Smart Exterior Kits.

Zone On/Off: Press each zone icon to turn LED On or Off.

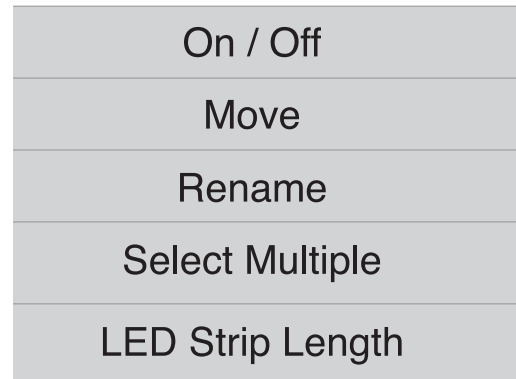

Move Zone Icon:

Press and hold zone icon, select **“Move”** to position each zone icon at your desired location.

Rename Zone Icon:

Press and hold zone icon, select **“Rename”** to rename each icon. (Note: Maximum 4 characters).

Select Multiple:

You can select and control multiple zones at once. Press and hold zone icon, select **“Select Multiple”** then select your desired zones by pressing **“Confirm”**. To ungroup your selection, press and hold zone icon and select **“Ungroup”**.

C LED Strip Length:

The Exterior Smart LED Kit includes 72" total LED strip length. Select the LED strip length for each zone to properly display scan effects on Scan Mode. Press and hold zone icon, select "LED Strip Length" to set the LED length. Default setting is 36" and the LED will scan within the 36" distance. To have the LED move the entire 72" distance, please select 72". Please refer to (figure 1) for example.

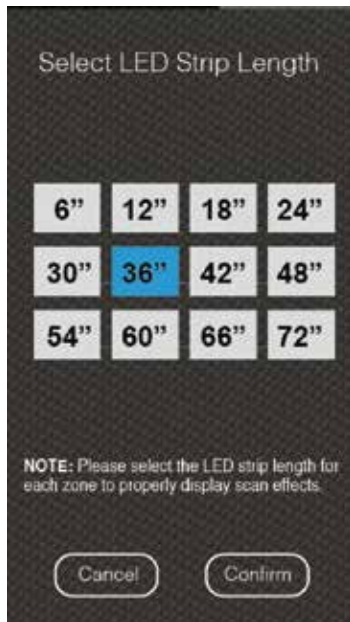

Select Vehicle Schematic:

Press >, select your desired vehicle schematic.

Figure 1 (Scan/Strip Length Examples)

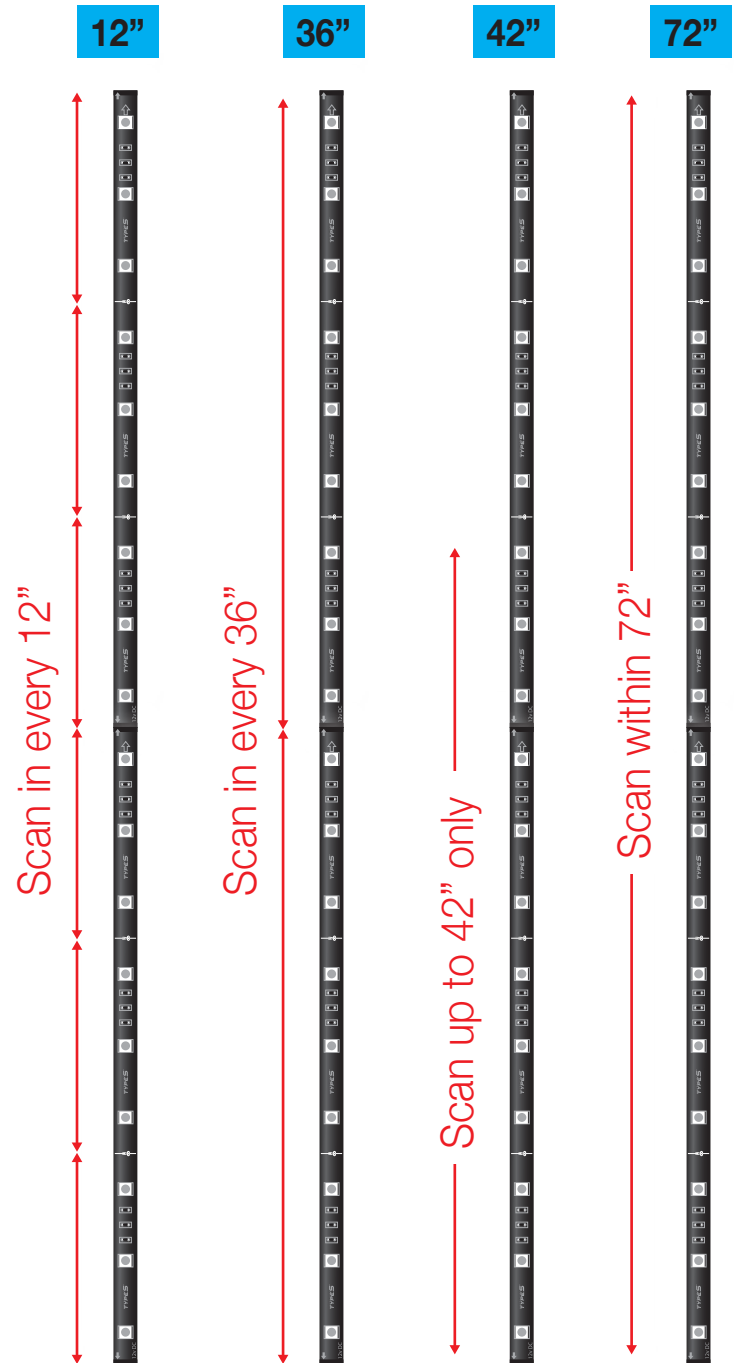

D Save Preset:

You can save your favorite settings. After creating your setting, press "Save Preset" and enter your preset name. You can save up to 10 preset settings.

Select Preset:

You can select your previously saved preset setting, press "Select Preset" and choose your saved setting.

Delete Saved Preset Setting:

To delete a saved preset setting, press "Select Preset" and press and hold the preset setting that you wish to delete. Press "Yes" to delete.

Select Color:

Choose from up to 49 different colors. Press "Select Color", select your desired color and press "Confirm".

E Brightness:

Slide bar to adjust brightness setting.

F LED Mode:

Choose up to 22 different modes including unique scan effects and Preset color themes.

Note: Music Mode is sound activated and sensor must be installed in car interior for proper use.

G Speed:

Slide bar to adjust the speed of the movement from each LED Mode.

OPTIONAL ACCESSORIES

TOURING ITEMS
TYPES **PLUG & GLOW™**
**ACCESSORIES AVAILABLE TO
TAKE YOUR EXPERIENCE TO
THE NEXT LEVEL**

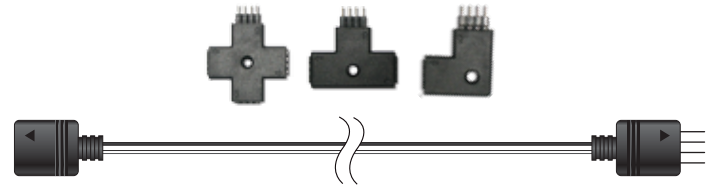

SPLITTERS & EXTENSION CABLES

For more product and installation ideas and videos visit us at:
www.winplususa.com