

TOURING ITEMS
TYPES[®]

720P SOLAR POWERED MIRROR BACKUP CAMERA

with **Smart Button**

WP ITM. BT530034
Care & Use Instructions



**Important, retain for future reference:
Read carefully**

BC

TABLE OF CONTENTS

1. Introduction	3
2. Package Contents	4
3. Product Specifications	5
4. Product Overview	5
5. Before You Install	7
6. Installation Guide	8
7. Smart Button Control Scheme	14
8. Settings and Operation	15
9. Safety Information	20
10. Maintenance & Warranty	23
11. General Information	26

1. INTRODUCTION

Please read all of the installation instructions carefully before installing the product. Improper installation will void manufacturer's warranty. The installation instructions do not apply to all types of vehicles, and are written as guidelines to assist in installing the system.

Consult an experienced technician if you are not comfortable installing the product. You can also contact TYPE S at **866.294.9244** to speak to one of our installation specialists if you have any specific questions regarding the Wireless Backup Camera.

BEFORE using the 720P Solar Powered Mirror Backup Camera with Smart Button, please read the safety information provided in this user manual. ALWAYS use the product as outlined in this user manual.

Please make sure to read and understand all local laws and regulations regarding cameras and their use in a vehicle. Laws vary by state.

2. PACKAGE CONTENTS

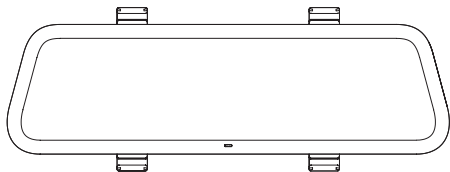

9.35" Touch Panel Mirror Monitor

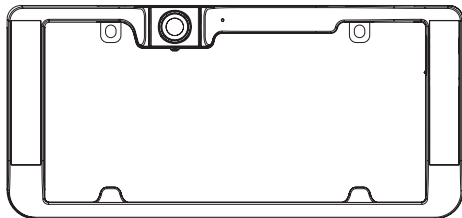

Solar Powered Wireless Backup Camera

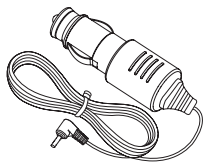

12V / 24V Power Adapter

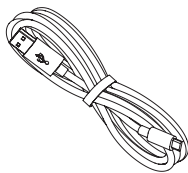

33" MicroUSB Charging /
Data Cable

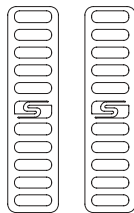

1 x Mounting Kit



250V 2A Spare Fuse

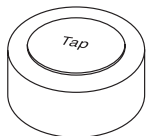

Smart Button

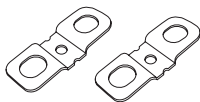

2 x Two-Way Mounting Tab
(Optional)

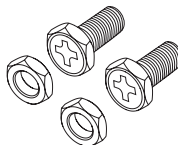

2 x Mounting Screw & Nut
(Optional)

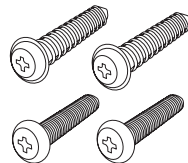

2 x License Plate
Machine Screw
2 x License Plate
Self-Tapping Screw
(Optional)

3. PRODUCT SPECIFICATIONS

Frequency:	2.4GHz
Operating Voltage:	Backup Camera - DC 5V Touch Panel Mirror Monitor - DC 12V/24V Smart Button - DC 3V (Operates with 1 pc CR2032 coin cell)
Operating Temperature:	14°F~122°F (-10°C~50°C)
Camera Water Resistance:	IP65 Rating
Rechargeable	Backup Camera - 5200mAh (Minimum Capacity 5000mAh)
Battery Capacity:	Touch Panel Mirror Monitor - 2000mAh
Maximum Signal Range:	33 Feet / 10 Meters (without interference or obstruction)

4. PRODUCT OVERVIEW

Solar Powered Wireless Backup Camera

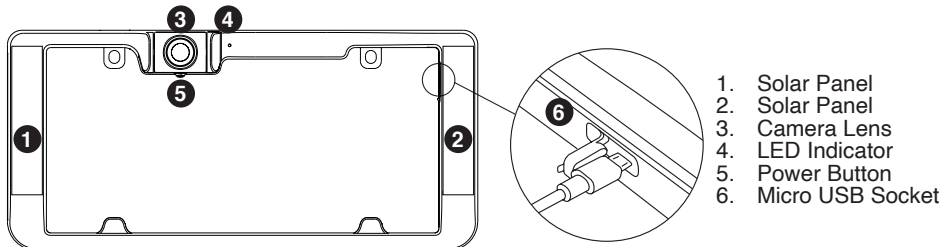

9.35" Touch Panel Mirror Monitor

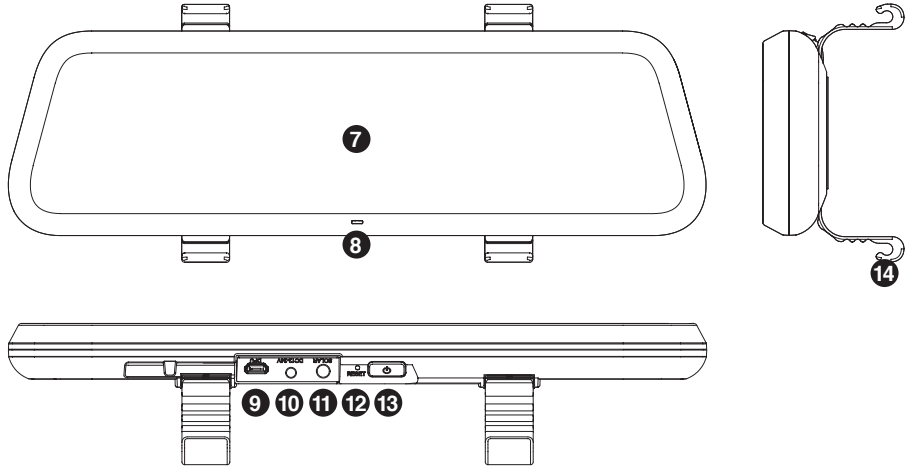

- 7. 9.35" Touch Panel
- 8. LED Indicator
- 9. MicroUSB input
(not for power input)
- 10. DC 12/24V Power Port
- 11. Power Jack for Portable Solar Panel
(Portable Solar Panel not Included)
* Sold Separately
- 12. Power Reset Hole
- 13. Power Button
- 14. Mounting Strap Fixing Anchors

Smart Button

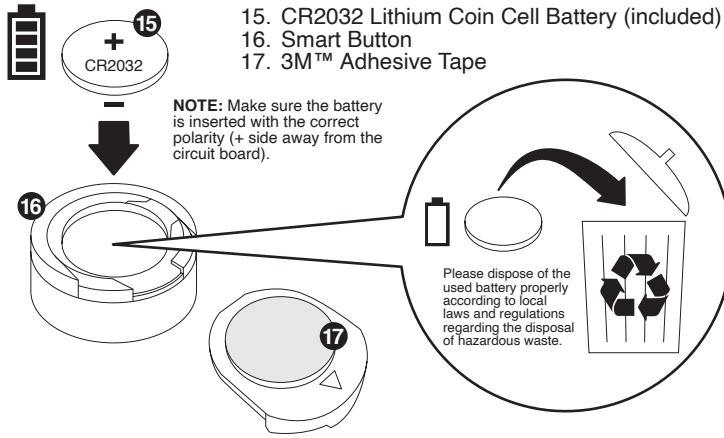

5. BEFORE YOU INSTALL

Please charge and test the Camera / Monitor before you install on your vehicle.

1. Fully charge camera. Fold back camera power port plug and insert included charging cable. Most AC wall adapters will work with the USB charging cable.
2. Plug in the Touch Panel Mirror Monitor, power on the Camera, and test connection. (Camera and Monitor come pre-paired)

6. INSTALLATION GUIDE

MOUNTING THE TOUCH PANEL MIRROR MONITOR

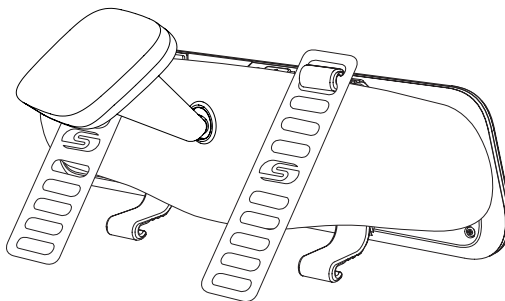

1. Place the Touch Panel Mirror Monitor in front of your existing rear view mirror and attach the rubber mounting straps to the top anchors of the Monitor.

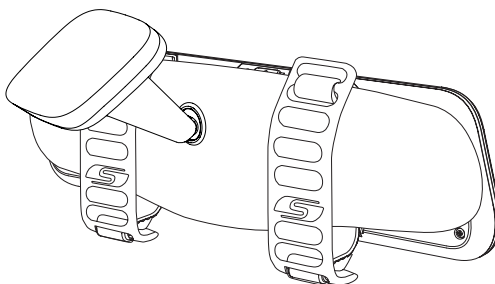

2. Reattach the rubber mounting straps to the bottom anchors to secure the Monitor in place.

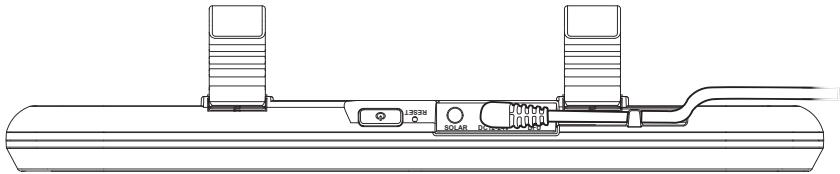

3. Plug the power cable into the DC 12/24V power port of the Mirror Monitor.

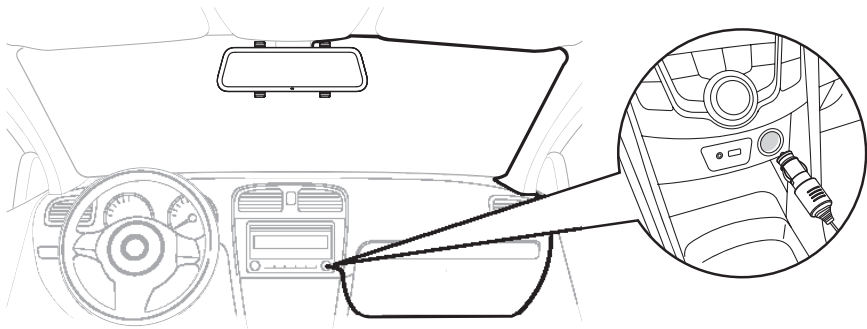

4. Route and hide the power cable in the headliner and pillars in your vehicle. Plug the power adapter into your vehicle's 12/24V DC outlet.

MOUNTING THE SMART BUTTON

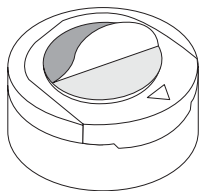

Peel off the tape backing from the back of the Smart Button and stick it to any flat surface of your dashboard that is easy to reach.

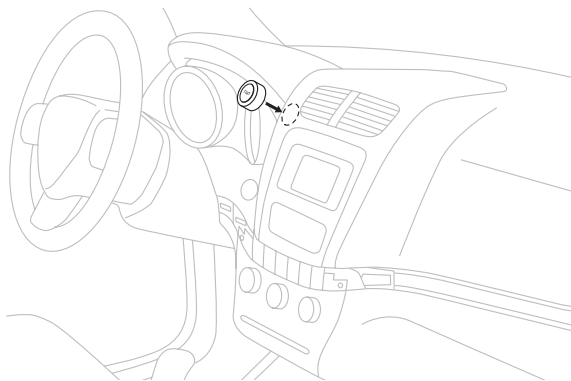

CHARGING THE WIRELESS BACKUP CAMERA

WARNING: Many vehicles provide constant power to the 12V outlet. If your outlet provides constant power, please remember to unplug the Touch Panel Mirror Monitor when not in use to avoid draining the vehicle battery.

CHARGING THE SOLAR POWERED WIRELESS BACKUP CAMERA

Fold back camera power port plug and insert included charging cable. Most AC wall adapters will work with the USB charging cable.

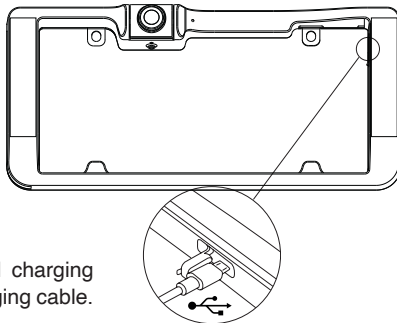

INSTALLING THE SOLAR POWERED WIRELESS BACKUP CAMERA

A) STANDARD INSTALLATION:



1. Unscrew your license plate.



2. Secure the Solar Powered Wireless Backup Camera and license plate with screws back onto the rear of your vehicle.

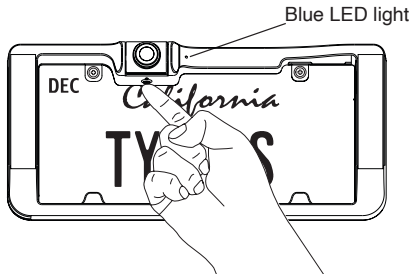

3. Push and hold the power button of the Solar Powered Wireless Backup Camera for 1 second, the blue LED light will flash 2 times.
4. Power on the Monitor with the 12V/24V adapter and you should see the parking view. You can do a variety of controls by pressing the Smart Button. (For more controls of the Smart Button refer to page 14)

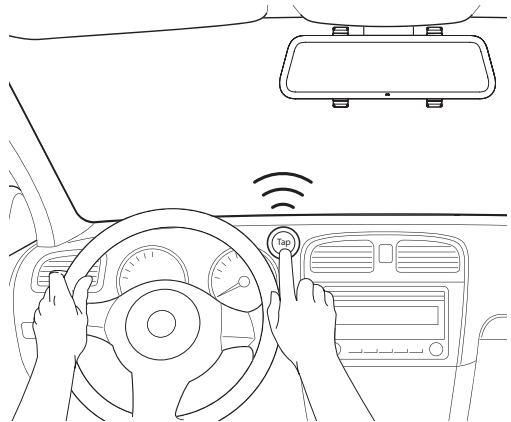

B) LOWERING INSTALLATION – FOR VEHICLES WITH TRUNK OR HATCH DOOR RELEASE
(This allows more clearance for finger tips to release door latch)

1. Unscrew and remove your license plate.

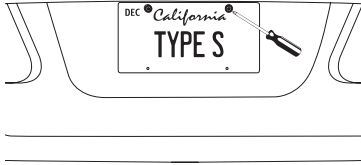

3. Install the license plate onto the Wireless Backup Camera with the Mounting Screws & Nuts.



- 2a. Unscrew and detach the original Mounting Tabs from the back of the Solar Powered Wireless Backup Camera.

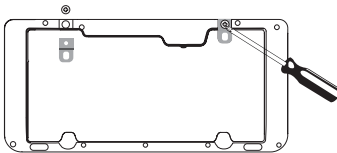

4. Secure the Solar Powered Wireless Backup Camera with the license plate back onto the rear of your vehicle.

- 2b. Install the Two-Way Mounting Tabs onto the Solar Powered Wireless Backup Camera.

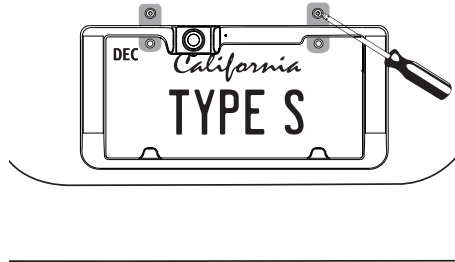
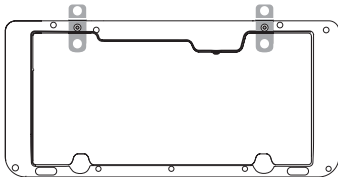

C) RAISED INSTALLATION – FOR TRUCKS & SUV WITH STEP BUMPERS (This will raise the camera frame out of the cavity of the step bumper)

1. Unscrew and remove your license plate.
2. Install the Two-Way Mounting Tabs using original Plates Screws and Mounting Screws.

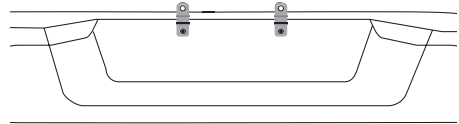

3. Finally, install the Wireless Backup Camera and license plate onto the rear of your vehicle and tighten the Mounting Nuts with a wrench.

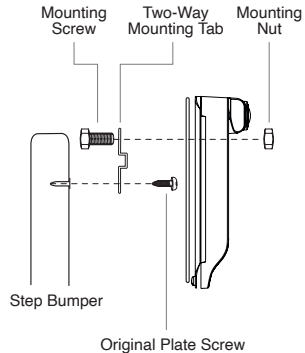

Warning: Lower tailgate on pickup trucks slowly and check for minimum ¼ inch clearance between gate and top of camera frame. This check is because some bumpers are installed higher than others.

ADJUSTING CAMERA LENS ANGLE

The camera's viewing angle can be adjusted to provide improved visibility, especially for large SUVs, or lifted trucks. Tilt the camera up or down for preferred viewing angle.

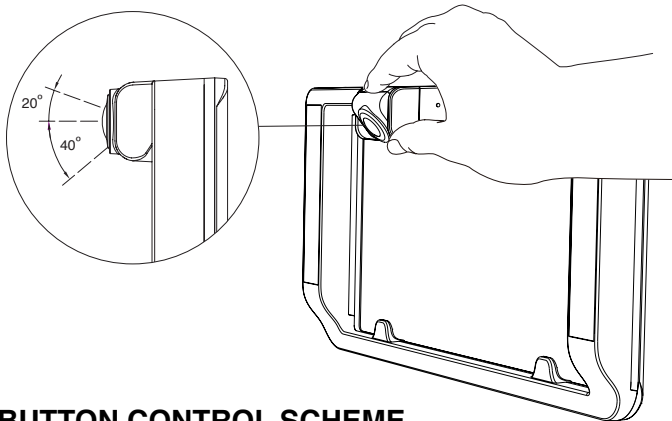

7. SMART BUTTON CONTROL SCHEME

VARIETY OF CONTROLS OF THE SMART BUTTON

Operation	Function
Press once during stand-by mode	Wakes up from stand-by mode.
Each press when the camera view is on	Cycle through Front View > Rear View > Dual Camera View.
Press twice when the camera view is on	Activates stand-by mode.
Press and hold for 5 seconds when the camera view is on	Activates pairing mode.

8. SETTINGS AND OPERATION

The monitor screen contains touch panel; all the operations can be done by tapping and swiping on the monitor screen. Tap on the **Tips** icon for on-screen instructions.

NOTE: Please remember to tap  to go back to camera view once you are done viewing the tips.

SPLIT SCREEN

If you purchase one set of 720P Solar Powered Mirror Backup Camera with Smart Button (BT530034) and extra Solar Powered Backup Camera (BT56780), you can tap on the  **Split Screen** icon to switch between different screen modes after you pair the extra camera with the Mirror Monitor.

NOTE: Other than BT530034, BT532629, BT530033, BT57132 and BT56780, DO NOT pair this monitor with other TYPE S backup cameras.

BATTERY INDICATORS

- The battery indicator with the letter C shows the battery level of the Wireless Backup Camera.
- The battery indicator with the letter M shows the battery level of the Mirror Monitor.

NOTE: Fully charge and test the camera before operation.

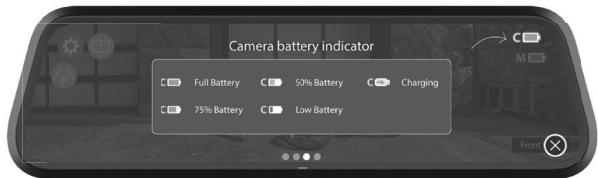
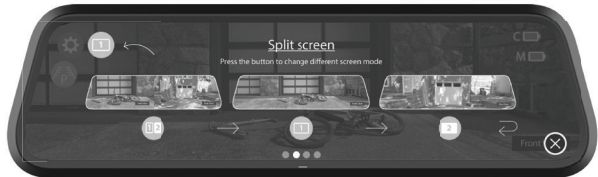
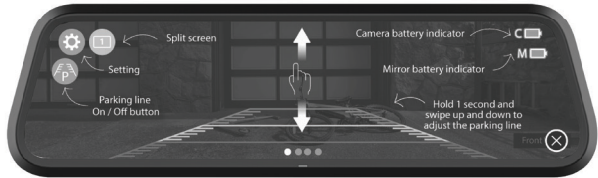

PAIRING CAMERA

The Solar Powered Wireless Backup Camera is pre-paired with the Touch Panel Mirror Monitor, and it is set as rear camera as default. You should see the following screen that shows the rear view if the Touch Panel Mirror Monitor is powered and the Solar Powered Wireless Backup Camera is fully charged.



If you can not see camera image showing on the Touch Panel Mirror Monitor, pair the Camera with the following steps:

1. Press and hold the Power Button under the camera for 6 seconds, or until the LED flashes Blue continuously. The camera will be turned on and enter Pairing Mode for one minute.
2. Or press and hold the Power Button for 5 seconds to enter Pairing Mode if the camera is already on.
3. On the Touch Panel Mirror Monitor, tap the  **Settings** icon and then tap  **Pair Camera** to enter the pairing screen. Tap **Front/Rear Camera - Click to pair**.

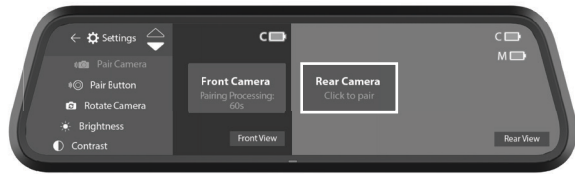
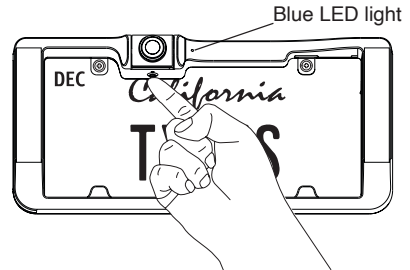

- The camera should be paired within 60 seconds. If the pairing is successful, the display will show “Pair OK”.
- If no camera is found, then the display will show “Pair Fail”. In this case, cut off power and reboot the Monitor. If you keep receiving the “Pair Fail” message after several attempts, please call our technical support to assist in troubleshooting.

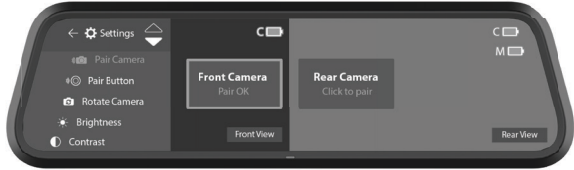
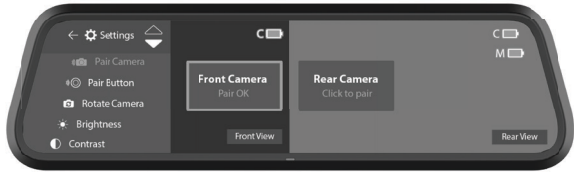

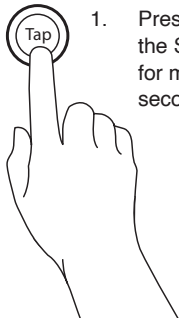

PAIRING THE SMART BUTTON WITH THE MIRROR MONITOR

The Touch Panel Mirror Monitor is already paired with the Smart Button. Follow these steps to repeat the pairing procedure if you have replaced the battery of the Smart Button:

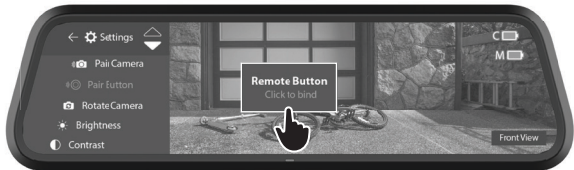

- Press and hold the Smart Button for more than 5 seconds.



- On the Settings page, tap the  **Pair Button** icon to enter the Pair Button screen, and then tap **Remote Button - Click to bind**. The Smart Button should be paired within 30 seconds.

ROTATE CAMERA

Tap on the setting to reverse the camera view.

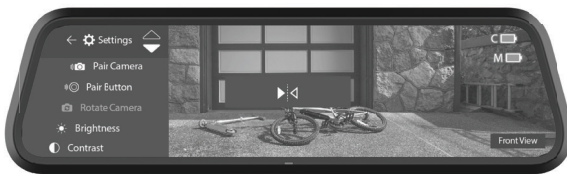

BRIGHTNESS

Swipe to adjust screen brightness.



CONTRAST

Swipe to adjust screen contrast.



OPERATION TIME

Tap to choose different operation time. The Monitor's parking view operation time will start to count down when you press the Smart Button. When the timer runs out, the parking view will automatically switch to stand-by mode.



PARKING AID LINE

You can turn ON/OFF the parking aid line by tapping the  icon.



ADJUST CAMERA VIEW

Swipe up and down to adjust view.

NOTE: You cannot adjust the parking aid line and camera view in the split screen mode.

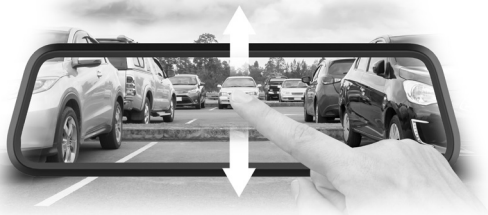

BACKUP CAMERA POWER, MODES & LED INDICATORS	
Power / Mode Status	LED Indicators
Power On Press and hold Power button for 1 second, Camera will power on.	Blue LED light flashes 2 times when Camera is powered on.
Power Off Press and hold Power button for 2 seconds and release, Camera will power off.	Red LED light flashes 1 time when the Camera is powered off.
Pairing Mode To begin Pairing Mode, press the Power button on Camera until blue LED light flashes quickly. Now Camera is in Pairing Mode.	Blue LED light flashes quickly for 1 minute or until pairing success is complete.
Low Battery Power Off Camera will power off when the battery is used up.	Red LED light flashes to indicate low battery.
USB Charging This LED light is next to the MicroUSB port.	While charging, the Red LED light will remain solid. When Camera is fully charged, Red LED light turns off.
TOUCH PANEL MIRROR MONITOR POWER, MODES & LED INDICATORS	
Low Battery Power Off Monitor will power off when the battery is used up.	Red LED light flashes to indicate low battery.
Charging Monitor is charged by the DC 12V/24V Power Source.	While charging, the Red LED light will remain solid. When Monitor is fully charged, Red LED light turns off.

TOUCH PANEL MIRROR MONITOR INDICATOR

If you see this message on the Monitor, that means the battery of the Solar Powered Wireless Backup Camera is lower than working voltage. Please fully charge the camera.

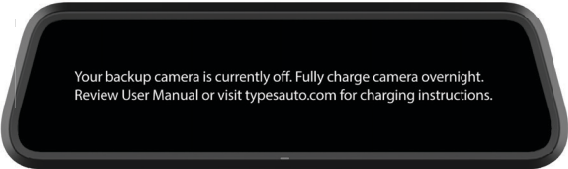

Your backup camera is currently off. Fully charge camera overnight.
Review User Manual or visit typesauto.com for charging instructions.

9. SAFETY INFORMATION

IMPORTANT SAFETY INSTRUCTIONS

1. SAVE THESE INSTRUCTIONS– This manual contains important safety and operating instructions of car charger for Model BT530034.
2. Before using the product, read all instructions and cautionary markings.
3. Do not expose car charger to rain, moisture, or snow.
4. Use of an attachment not recommended or sold by the product manufacturer may result in a risk of fire, electric shock, or injury to persons.
5. To reduce risk of damage to cigarette lighter connector and cord, pull by cigarette lighter connector rather than cord when disconnecting car charger.
6. Make sure cord is located so that it will not be stepped on, tripped over, or otherwise subjected to damage or stress.
7. Do not operate car charger with damaged cord or cigarette lighter connector – replace it immediately.
8. Do not operate car charger if it has received a sharp blow, been dropped, or otherwise damaged in any way; take it to a qualified serviceperson.
9. Do not disassemble car charger; take it to a qualified serviceperson when service or repair is required. Incorrect reassembly may result in a risk of electric shock or fire.
10. To reduce risk of electric shock, unplug charger before attempting any maintenance or cleaning. Turning off controls will not reduce this risk.

BATTERY SAFETY INSTRUCTIONS

1. Swallowing the batteries may lead to serious injury or death. If swallowed go straight to a medical emergency room.
2. Clean batteries and the battery contacts before inserting if necessary with a clean, dry cloth.
3. Always purchase the correct size and grade of batteries that are most suitable for the intended use.
4. Ensure the batteries are installed correctly with regard to polarity (+ and -). Wrongly inserted batteries may cause battery leakage and cause damage to the device or other harmful.
5. Remove batteries when they are not used for an extended period of time.
6. Remove used batteries promptly.
7. Keep batteries out of children's reach.
8. Do not charge, dismantle, throw into fire, or short-circuit the batteries.
9. If a battery has leaked, avoid contact with skin, eyes, and mucous membranes. Promptly rinse any affected area with water and seek medical assistance.

WARNING: A failure to read and follow these warnings and instructions may result in a serious accident, including damaged property or a serious injury, including loss of life.

- The 720P Solar Powered Mirror Backup Camera is designed as an aid to the driver in detecting large stationary objects to help avoid damaging the vehicle. However, you, the driver, must use it safely and properly. Use of the 720P Solar Powered Mirror Backup Camera is not a substitute for safe, proper and legal driving.
- Never back up while looking only at the screen. You should always check behind and around the vehicle when backing up just as you would if the vehicle did not have the Solar Powered Wireless Backup Camera. Always make sure your intended path is clear. If you back up while looking only at the Mirror Monitor, you may hit a vehicle, pedestrian, bicyclist, child, pet or other object resulting in injury or death. Always back up slowly.
- Never depend on the 720P Solar Powered Mirror Backup Camera entirely when backing up. The image on the screen is different from actual conditions. Objects viewed in the Mirror Monitor may differ from actual distance because a wide-angle lens is used. Objects in the Mirror Monitor will appear visually opposite than when viewed in the rear view and outside mirrors.
- The 720P Solar Powered Mirror Backup Camera “night vision” feature that is high performance brightness with colorful image is an aid to a driver but is limited. Always use your own eyes to confirm the vehicle’s surroundings, as the displayed image may be faint or dark, distorted, or not entirely visible. Always check behind and all around the vehicle visually with mirrors before proceeding.
- The area displayed by the 720P Solar Powered Mirror Backup Camera is limited. The 720P Solar Powered Mirror Backup Camera does not display objects that are close to or below the bumper, underneath the vehicle, or objects out of the camera’s field of view. The area displayed on the Mirror Monitor may vary according to vehicle orientation or road conditions.
- Be sure to check the Camera’s position and mounting angle before each use.
- Make sure the trunk, hatch, or backdoor is completely and securely closed when backing up.
- If the back of the vehicle is hit, the position and mounting angle of the 720P Solar Powered Mirror Backup Camera may change.

- When washing the vehicle with high pressure water, be sure not to spray it around the 720P Solar Powered Mirror Backup Camera. Otherwise, water may enter the camera unit causing water condensation on the lens, a malfunction, fire or an electric shock.
- Do not strike the 720P Solar Powered Mirror Backup Camera. It is a precision instrument. Otherwise, it may malfunction or cause damage resulting in a fire or an electric shock.
- This product will only provide images of items that are within the field of view of the 720P Solar Powered Mirror Backup Camera. Thus, it is imperative that the 720P Solar Powered Mirror Backup Camera should be kept clean and unobstructed, and should be mounted so that its field of view includes the entire area behind your vehicle.
- Adhere to all applicable traffic laws and motor vehicle regulations applicable to the device.
- Consult local laws and regulations for any restrictions on installation or use.
- Never allow children to play with the device. Small parts may be a choking hazard.
- The 720P Solar Powered Mirror Backup Camera has a water resistant construction. Do not detach, disassemble or modify it. This may cause incorrect operation.
- Do not submerge 720P Solar Powered Mirror Backup Camera in water, which can cause internal damage to the camera.
- If the temperature changes rapidly, such as when hot water is poured on the vehicle in cold weather, the system may not operate normally. The Digital Camera can withstand the effects of rain, snow, and inclement weather.
- When strong light directly enters a camera, objects may not be displayed clearly.
- The Mirror Monitor screen may flicker under fluorescent light.
- The colors of objects on the Mirror Monitor may differ somewhat from those of the actual object.
- If dirt, rain or snow attaches to the camera, the Mirror Monitor may not clearly display objects. If water droplets, snow or mud adhere to the camera lens, rinse with water and wipe with a dry cloth.
- Do not use alcohol or thinner to clean the camera. This will cause discoloration. To clean the camera, wipe with a clean cloth dampened with mild cleaner diluted with water and then wipe with a dry cloth.
- Will work up to 33 feet.

- ALWAYS engage Parking/Emergency/Hand Brakes of the vehicle when testing the system.

SAFETY AROUND AND BEHIND OTHER VEHICLES

Using a 720P Solar Powered Mirror Backup Camera is not enough to completely overcome a vehicle's blind spot. Many preventable injuries and deaths occur in driveways or parking lots when drivers do not see children, pets, or others near their vehicles. Here are a few safety tips that will help you to avoid a back-over accident:

- Walk completely around your vehicle before getting in. Check for kids, toys, and pets before entering the vehicle and starting the engine.
- Know where children are. Have children stand in a place where they are in full view.
- Be aware of young children. Young children are small and hard to see.
- Parents, caregivers and all adults need to be vigilant in supervising children, especially when children are in the yard, driveway or parking lot playing near parked cars.
- Roll down your window so you will be able to hear what is happening outside your vehicle.
- Owners of SUVs, trucks, and vans need to take extra care to avoid hitting or running over a child.
- Teach children to move away from a vehicle whenever it is started.

10. MAINTENANCE & WARRANTY

CLEANING

- If dirt, rain or snow attaches to the camera, the Mirror Monitor may not clearly display objects. If water droplets, snow or mud adhere to the camera lens, rinse with water and wipe with a dry cloth.
- Do not use alcohol, benzene or thinner to clean the camera. This will cause discoloration. To clean the camera, wipe with a clean cloth dampened with mild cleaner diluted with water and then wipe with a dry cloth.

WARRANTY

- **TYPE S LIMITED WARRANTY**

TYPE S warrants, to the original purchaser, that its products are free from defects in

material and workmanship for 1 year from the date of original purchase. Where permitted by law, TYPE S's liability shall be limited to that set forth in this limited express warranty. This limited express warranty shall be the exclusive remedy of the purchaser and TYPE S makes no other warranty of any kind aside from the limited express warranty stated above.

NOTE: Warranty only applies for North American customers of purchases made in North America.

- **CONDITIONS OF WARRANTY**

If during the 1 year warranty period your new product is found to be defective, TYPE S will repair such defect, or replace the product, without charge for parts or labor subject to the following conditions:

1. All repairs must be performed by TYPE S.
2. All warranty claims must be accompanied by a copy of the sales receipt or bill of sale.
3. The equipment must not have been altered or damaged through negligence, accident, improper operation, or failure to follow the product instructions for installation, use, or care.
4. The replacement of parts is excluded from the warranty when replacement is necessary due to normal wear and tear.
5. Repair or replacement parts supplied by TYPE S under this warranty are protected only for the unexpired portion of the original warranty.
6. This is a "repair or replace" warranty only, and does not cover the costs incurred for the installation, removal or reinstallation of the product, or damage to any mobile phone device or vehicle.

- **OWNER'S RESPONSIBILITIES:**

TYPE S will make every effort to provide warranty service within a reasonable period of time. SHOULD YOU HAVE ANY QUESTIONS ABOUT SERVICE RECEIVED OR IF YOU WOULD LIKE ASSISTANCE IN OBTAINING SERVICE, PLEASE CALL TOLL FREE 1.866.294.9244 DURING REGULAR BUSINESS HOURS MONDAY THROUGH FRIDAY 8:00 AM TO 5:00PM.

NOTE: Toll Free # is for North America Customers ONLY. See Customer service section for customer contact numbers for other regions/offices.

For customer service and technical support, please call us at 1.866.294.9244. If at that time it is determined that a replacement unit is needed, the support representative will issue a Return Authorization and instruct on how to get a new unit.

TYPE S makes no other warranty of any kind aside from the limited express warranty stated herein.

DISCLAIMER OF WARRANTIES, INCLUDING WARRANTY OF MERCHANTABILITY AND WARRANTY OF FITNESS FOR PARTICULAR PURPOSE: EXCEPT AS SPECIFICALLY SET FORTH HEREIN, NO WARRANTY OR REPRESENTATION, EXPRESS OR IMPLIED, IS MADE AS TO THE 720P SOLAR POWERED MIRROR BACKUP CAMERA. EXCEPT AS EXPRESSLY SET FORTH HEREIN, TYPE S AND/OR ITS AFFILIATES EXPRESSLY DISCLAIMS, WITHOUT LIMITATION, ANY STATUTORY WARRANTIES AND ALL IMPLIED WARRANTIES, INCLUDING ANY IMPLIED WARRANTY OF MERCHANTABILITY OR FITNESS FOR A PARTICULAR PURPOSE.

TYPE S and/or its affiliates do not guarantee or promise that the user of 720P Solar Powered Mirror Backup Camera will not be in an accident or otherwise not collide with an object and/or person. Our 720P Solar Powered Mirror Backup Camera is not intended in any way to be a substitute for careful and cautious driving or for the consistent adherence to all applicable traffic laws and motor vehicle safety regulations.

The 720P Solar Powered Mirror Backup Camera is not intended to be a substitute for rearview mirrors or for any other motor vehicle equipment mandated by law. Even when properly installed, our 720P Solar Powered Mirror Backup Camera has a limited field of vision and does not provide a comprehensive view of the rear area of the vehicle. You should always look around outside your vehicle and use your mirrors to confirm rearward clearance and that your vehicle can back up safely.

TYPE S and/or its affiliates are not responsible for a user's intended or actual use of the 720P Solar Powered Mirror Backup Camera. In no event shall TYPE S and/or its affiliates have any liability for any losses (whether direct or indirect, in contract, tort or otherwise) incurred in connection with the 720P Solar Powered Mirror Backup Camera, including but not limited to damaged property, personal injury and/or loss of life. Neither shall TYPE S and/or its affiliates have any liability for any decision, action or inaction taken by any person in reliance on the 720P Solar Powered Mirror Backup Camera, or for any delays, inaccuracies and /or errors in connection with the 720P Solar Powered Mirror Backup Camera and its functioning.

TYPE S and/or its affiliates shall have no responsibility or liability for damage and/or injury resulting from accidents occurring with vehicles having the installed, and TYPE S and/or its affiliates, the manufacturer, distributor and seller shall not be liable for any injury, loss or damage, incidental or consequential, arising out of the use or intended use of the product.

CAUTIONS

Check your state or provincial laws before installing. Vehicle owner must comply with all applicable laws. This product is intended solely for parking aid purposes. Manufacturer and Seller assume no liability for installation or use, which are solely the responsibility of the purchaser. This product is not DOT approved and is designed and intended for parking aid uses only. Do not install or use product if it, in any way, impairs the safe operation of your vehicle.

11. GENERAL INFORMATION

CUSTOMER SERVICE/CONTACT

IF YOU ARE EXPERIENCING ANY ISSUES WITH THE PRODUCT DURING OPERATION, DO NOT RETURN THE PRODUCT TO THE STORE. CONTACT TYPE S DIRECTLY FOR INSTRUCTIONS ON HOW TO RETURN/EXCHANGE THE PRODUCT.

FCC / IC Compliance Statement:

This device contains licence-exempt transmitter(s) that comply with Innovation, Science and Economic Development Canada's licence-exempt RSS(s) and Part 15 of the FCC rules.

Operation is subject to the following two conditions: (1) This device may not cause harmful interference, and (2) this device must accept any interference received, including interference that may cause undesired operation.

Warning: Changes or modifications to this unit not expressly approved by the party responsible for compliance could void the user's authority to operate the equipment. The manufacturer is not responsible for any radio or TV interference caused by unauthorized modifications or change to this equipment. Such modifications or change could void the user's authority to operate the equipment.

NOTE: This equipment has been tested and found to comply with the limits for Class B digital device, pursuant to part 15 of the FCC Rules. These limits are designed to provide reasonable protection against harmful interference in a residential installation. This equipment generates, uses and can radiate radio frequency energy and, if not installed and used in accordance with the instructions, may cause harmful interference to radio or television reception, which can be determined by turning the equipment off and on, the user is encouraged to try to correct the interference by one or more of the following measures:

- Reorient or relocate the receiving antenna.
- Increase the separation between the equipment and the receiver.
- Connect the equipment into an outlet on a circuit different from that to which the receiver is connected.
- Consult the dealer or an experienced radio/TV technician for help.

This equipment complies with FCC RF radiation exposure limits set forth for an uncontrolled environment.

CAN ICES-3 (B)/NMB-3(B)

720P Solar Powered Mirror Backup Camera

with Smart Button

BT530034

Responsible Party:

TYPE S

2975 Red Hill Ave., Ste. 100, Costa Mesa, CA 92626, U.S.A.

Tel: 866-294-9244

TYPES[®]

A Horizon Brands Company
2975 Red Hill Ave., Ste. 100, Costa Mesa, CA 92626, U.S.A.
1.866.294.9244 | info@typesauto.com
©2021 TYPE S. All rights reserved.

www.typesauto.com

ML-530034_V1