

TOURING ITEMS
TYPES[®]

2K 360 DASH CAM PRO

WITH HDR

WP ITM. BT530025
Care & Use Instructions



**Important, retain for future reference:
Read carefully**

TABLE OF CONTENTS

1. Introduction	1
2. Package Contents	2
3. Product Specifications	3
4. Product Dimension	3
5. Product Overview	4
6. Installation	5
7. Connect to Power	7
8. Dash Cam Modes & LED Indicators	8
9. Initial Setup	8
10. Recording Time	9
11. Technical Specifications	9
12. Download the APP	10
13. Pair the Dash Cam with the APP	11
14. Using the APP	13
15. Live Streaming	18
16. Dash Cam Configuration & Menu Settings	22
17. Viewing and managing media files using a computer	27
18. Safety Information	28
19. Maintenance & Warranty	30
20. General Information	33

1. INTRODUCTION

Please read all of the installation instructions carefully before installing the product. Improper installation will void manufacturer's warranty. The installation instructions do not apply to all types of vehicles, and are written as guidelines to assist in installing the system.









Consult an experienced technician if you are not comfortable installing the product. You can also contact Type S at **1.866.294.9244** to speak to one of our installation specialists if you have any specific questions regarding the 2K 360 Dash Cam Pro.

BEFORE using the 2K 360 Dash Cam Pro, please read the safety information provided in this user manual. ALWAYS use the product as outlined in this user manual.

Please make sure to read and understand all local laws and regulations regarding cameras and their use in a vehicle. Laws vary by state.

2. PACKAGE CONTENTS

1. 1 x 2K 360 Dash Cam Pro
2. 1 x 12V Hardwire Cable
3. 1 x 12V Cigarette Charger Cable
4. 1 x Mount with 3M VHB™ Double-sided Tape
5. 2 x Cable Ties
6. 2 x Snap Locks
7. 1 x 3M VHB™ Double-sided Tape (Spare)
8. 1 x 32GB MicroSD Card (Class 10) maximum support 128GB MicroSD

1. 	5. 
2. 	6. 
3. 	7. 
4. 	8. 

3. PRODUCT SPECIFICATIONS

Screen:	2.4" IPS
Resolution:	2K
Frequency:	2.4 GHz
Operating Voltage:	Hardwire - DC 12V only, Cigarette Charger - DC 12V / DC 5V (USB-A)
Operating Temperature:	14°F~140°F (-10°C~60°C)
Viewing Angle:	240° (Fisheye FOV)
Image Sensor:	5MP
Maximum Signal Range:	9.84 Feet / 3 Meters (without interference or obstruction)

4. PRODUCT DIMENSION

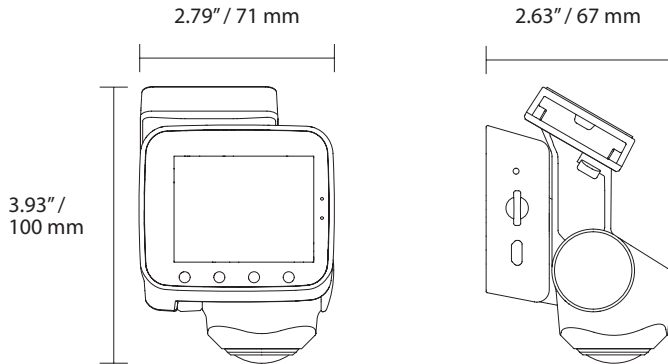

5. PRODUCT OVERVIEW

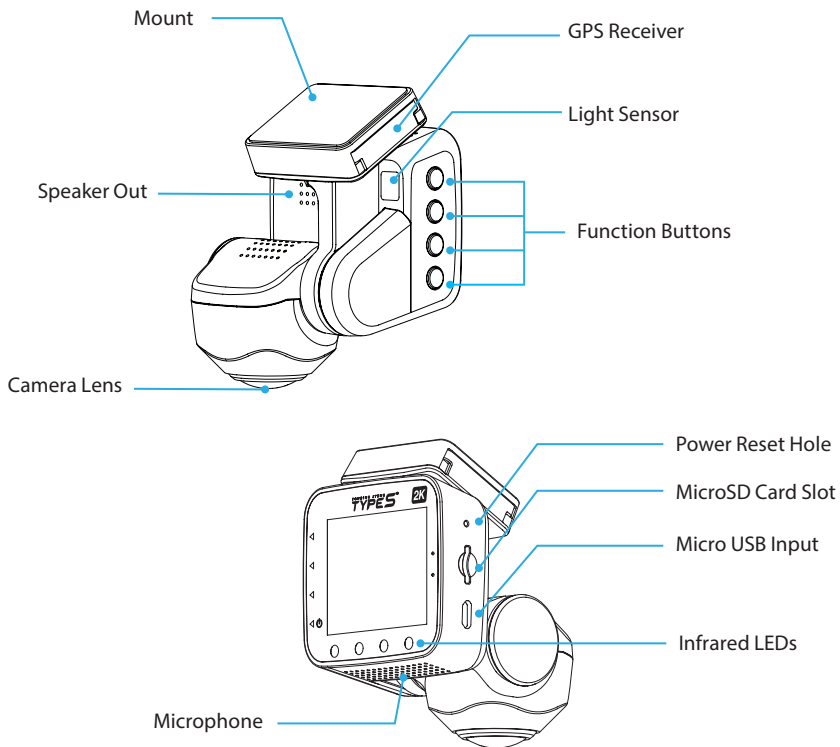

6. INSTALLATION

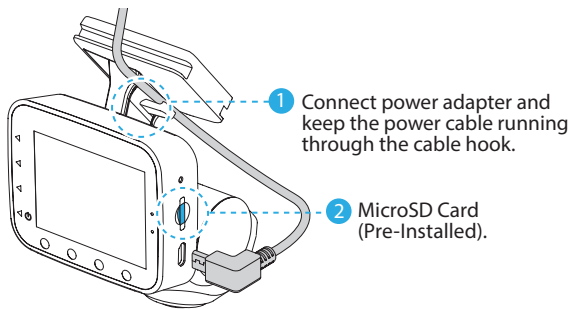

- 3 Check the live screen in Type S Drive APP and determine the most suitable mounting position. (See page 10-22 on using the APP.)

Warning: Do not install the product in a location where it can obstruct the driver's field of vision.

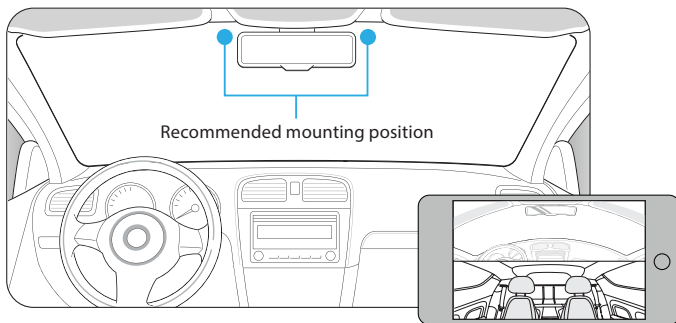

- 4 Connect mount to the 2K 360 Dash Cam Pro from left or right.

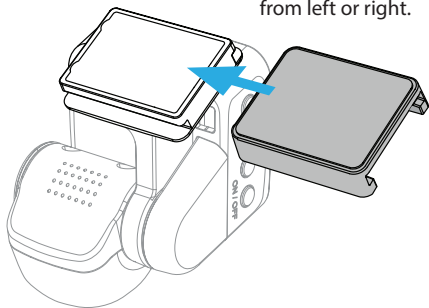

- 5 Attach the mount with cam to the windshield.

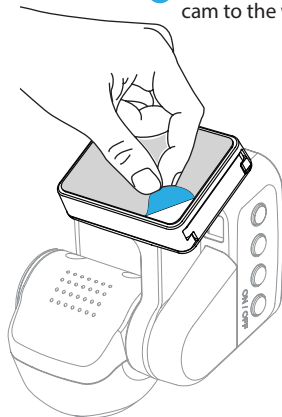

- 6 Route and hide the power cable in the headliner and pillars in your vehicle.

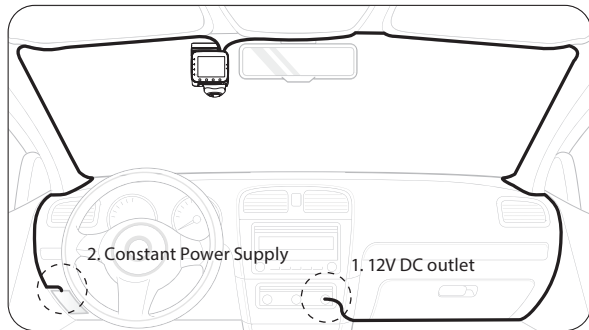

Option 1 - Plug the Cigarette Charger Cable into the 12V DC outlet.

OR

Option 2 - Connect the Hardwire Cable into a 12V DC constant power supply.

7. CONNECT TO POWER

Option 1 - Connect to 12V or 5V DC outlet

Plug the Cigarette Charger Cable into a 12V DC outlet and turn on the engine, the Dash Cam will start recording.

- Notes:**
- 12V DC outlet does not provide constant power, the 2K 360 Dash Cam Pro will not be able to record in Park & Record Mode when the vehicle's engine is turned off.
 - 2K 360 Dash Cam Pro can be used as a handheld action cam when connected to a 5V DC power source such as a power bank, with a Micro USB Cable (not included).

Option 2 - Hardwire to a constant power supply

In order to enable the Park & Record Mode user must hardwire the 2K 360 Dash Cam Pro to the vehicle's fuse panel using the hardwire cable provided.

Refer to your vehicle owner's manual/handbook, identify a place in your vehicle that has constant power source and connect the DC 12V hardwire cable to it. Connect the **BLACK** cable to negative (-) terminal, and then Connect the **RED** cable to positive (+) terminal.

Note: Constant power supply means power is supplied to the Dash Cam even when the vehicle's engine is turned off.

Caution: Park & Record Mode and low voltage power cut-off function will be disabled if the hardwire connection is done without the use of the DC 12V hardwire cable that comes with the package.

Note: The 2K 360 Dash Cam Pro has two recording modes: 1) Normal Mode and 2) Park & Record Mode. The Dash Cam starts recording in Normal Mode, and switches to Park & Record Mode when the engine is off. A low voltage power cut-off function protects your vehicle battery from over-drain.

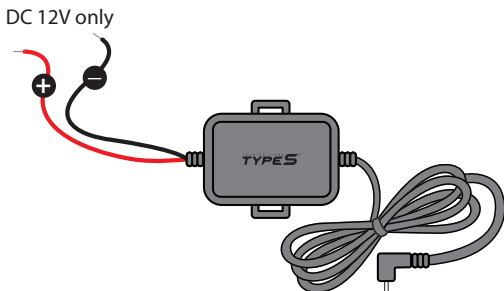

8. DASH CAM MODES & LED INDICATORS

Power / Mode Status	LED Indicators
Power On Dash Cam powers ON when the engine is turned on. Alternatively, press and hold the power button for more than 3 seconds to power on the Dash Cam.	Red LED light stays on when Dash Cam is powering on.
Power Off Dash Cam powers OFF when the engine is turned off. Alternatively, press and hold the power button for more than 3 seconds to power OFF the Dash Cam.	Red LED light flashes 1 time when the Dash Cam is powering off.
Normal Mode	Red LED light flashes.
Park & Record Mode	Blue LED light flashes.
Live Stream	Red LED light stays on during a live stream section.
Firmware Upgrade	Red and blue LED lights flash together.
Default Setting	Red and blue LED lights flash together.

9. INITIAL SETUP

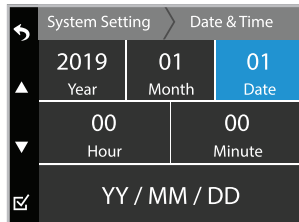

This menu will appear when The 2K 360 Dash Cam Pro is first turned on. Set the date and time before using the 2K 360 Dash Cam Pro as this will affect the time stamp on all recorded media files.

10. RECORDING TIME

Memory Card Capacity	Total Recording Time
16GB	At least 73 minutes
32GB	At least 146 minutes
64GB	At least 292 minutes
128GB	At least 584 minutes

Note: If you use your own MicroSD card please insert it into the Dash Cam and use the format function under system setting page (refer to page 26) before first use.

11. TECHNICAL SPECIFICATIONS

Memory Management

Memory Card Capacity	System Reserve	Event	Photo	Video
16GB	1GB	30% = 4.6GB	5% = 0.75GB	65% = 9.75GB
32GB	1GB	30% = 9.3GB	5% = 1.55GB	65% = 20.15GB
64GB	1GB	30% = 18.9GB	5% = 3.15GB	65% = 40.95GB
128GB	1GB	30% = 38.1GB	5% = 6.35GB	65% = 82.55GB

Park & Record Mode

The Dash Cam will switch into Park & Record Mode 10 minutes after the vehicle engine is off and the vehicle is not moving. WiFi and LCD screen will be off during Park & Record Mode. Dash Cam switches back to Normal Mode when engine starts. This feature is only available when the Dash Cam is connected through hardwiring.

Low voltage power cut-off

When the Dash Cam is connected to the vehicle's constant power source through hardwiring, it will monitor vehicle battery's voltage. Dash Cam will perform low voltage cut-off when 1) voltage drops below 12V for 30 minutes, or 2) voltage drops below 11.6V for 10 minutes.

High temperature power cut-off

This function prevents the Dash Cam from overheating. The Dash Cam will shut down automatically if its temperature reaches around 90 °C (194 °F) in Park & Record Mode, or 100 °C (212 °F) in Normal Mode. Dash Cam will resume operation when temperature drops to 80 °C (176 °F).

12. DOWNLOAD THE APP

The 2K 360 Dash Cam Pro auto sync function enables you to control and play back recorded media files using your smartphone with the Type S Drive APP. Scan below QR code or search "Type S Drive" in the APP Store or Google Play. Download and install the APP.



Compatible with iPhone 4s and higher, iPad3, iPad Mini, iPad Air and higher, and iPod touch 5th Generation and higher.
Requires iOS 9.0 or higher.



Compatible with phones with Android™ 5.0 or higher.

Once installed, open the APP and begin enjoying your Type S Drive APP.

Note: The APP is only available on smartphones with Apple iOS 9 or newer, and Android 5.0 or newer. The Type S Drive APP is not accessible from tablets, browsers, or PCs.

Tip: Check out the installation video at www.typesauto.com to help familiarize yourself with the installation process before starting.

13. PAIR THE DASH CAM WITH THE APP

Auto sync with the Dash Cam

WiFi icon will appear on LCD screen 10 seconds after Dash Cam is powered on.

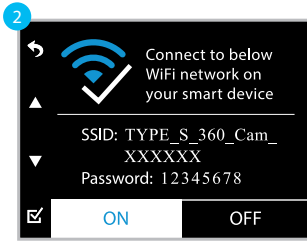
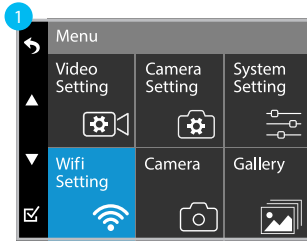

Android Device

1. Open the 2K 360 Dash Cam Pro's main menu and navigate to **WiFi Setting**.
2. Go to **WiFi Setting** and turn it on.
Note: Default WiFi is set as ON.
3. Open the Type S Drive APP and tap the Dash Camera category.
4. Select 360 Dash Cam from the list of Dash Cams. Tap **Set Up Device**.

Note: After the initial sync, the **Set Up Device** tap will be changed to **Connect** next time you do the auto sync.

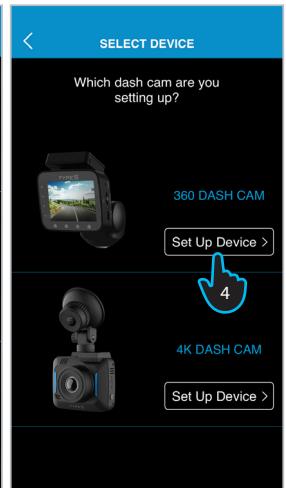
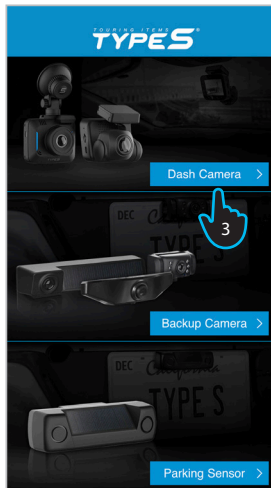

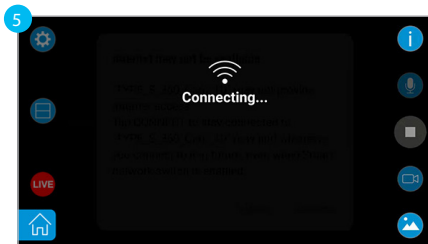

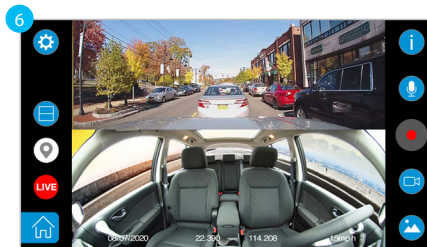

- The APP will switch to the live view screen and searches for the Dash Cam's SSID which begins with its model number "TYPE_S_360_Cam_XXXXXX" and connects to the Dash Cam automatically.

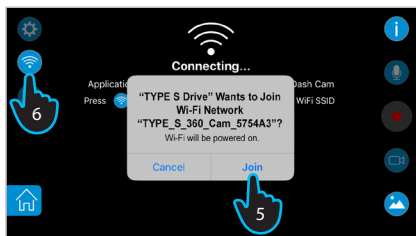

- You should see the live view of Dash Cam if the connection is successful.

iOS Device (Follow step 1 - 4 from previous instruction)



- Tap **Join** when the APP prompts you to join the Dash Cam's WiFi network "TYPE_S_360_Cam_XXXXXX"
- Or tap the  WiFi setting icon to go to APP permissions setting page.

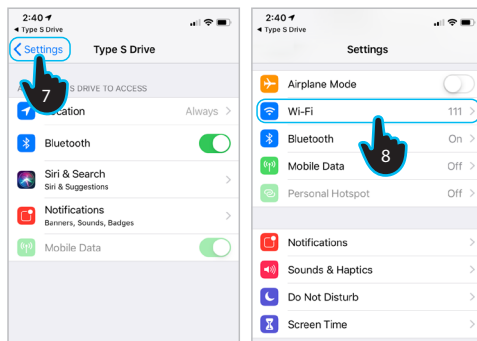

- Tap **Settings** on the APP permissions setting page.
- Scroll to the top, and tap to enter the WiFi setting page.

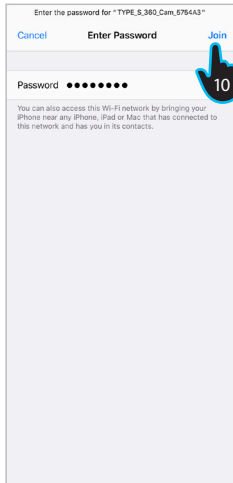
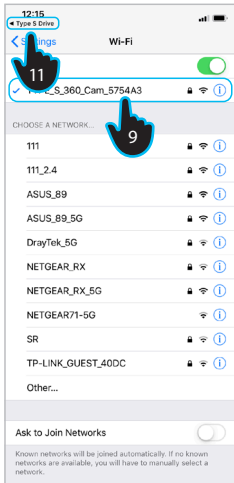

9. Choose "TYPE_S_360_Cam_XXXXXX".
10. Enter the default password "12345678" and tap **Join**.
11. Tap **Type S Drive** icon to return to the Type S Drive APP.
12. You should see the live view of the Dash Cam on the main interface.



14. USING THE APP

Main Interface



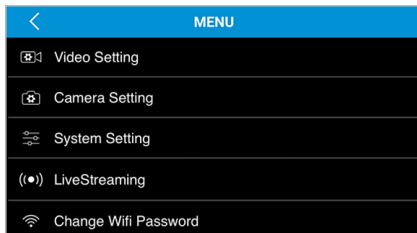

Main Menu

The default settings of the 2K 360 Dash Cam Pro will allow you to use it without the need to change any settings. However, you can still customize the Dash Cam any way you prefer. Tap the  icon to enter the Main Menu.

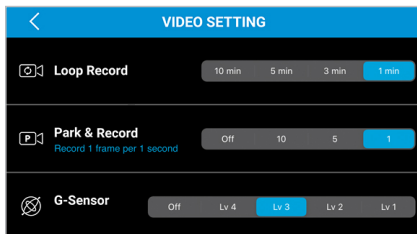

Video Setting

Loop Record - Select the duration of each recorded footage.

Park & Record - Select the interval value (in second) the Dash Cam captures each frame when the Park & Record Mode is activated.

G-Sensor - Select the level of sensitivity of G-Sensor.

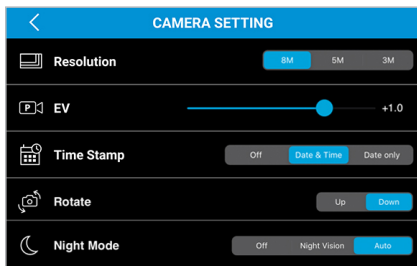

Camera Setting

- **Resolution** - Select the resolution of recorded footages.
- **EV** - Exposure Value.
- **Time Stamp** - Select choices of time stamp on recorded footages.
- **Rotate** - The default camera view is set to Down. Select rotate if your mounting angle requires you to flip the Dash Cam by 180 degrees.
- **Night Mode** - Turning the Night Vision Mode ON, OFF or AUTO,

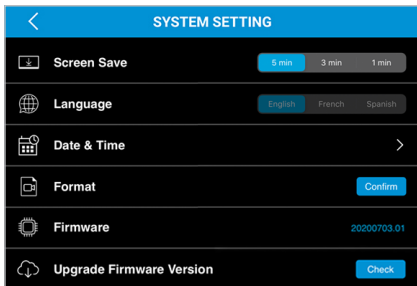

System Setting

- Screen Save - Select the period of inactivity before the Dash Cam's LCD screen shut down automatically.
- Language - Choose your preferred language for the Dash Cam's menu.
- Date & Time - Set up the date and time.
- Format - Erase everything on the MicroSD card.
- Default Setting - Reset the Dash Cam to default settings.
- Firmware - Shows the current Dash Cam firmware version.
- Upgrade Firmware Version - Tap to check and download the latest firmware and apply to the Dash Cam.
- Upgrade - Appears as Up to date if the Dash Cam has the latest firmware.

(Note: Make sure MicroSD card is present, and the Dash Cam is connected to power during firmware upgrade process.)

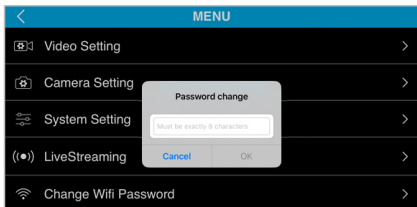

Change WiFi Password

- We suggest user to reset the Dash Cam WiFi password after the initial connection in order to block unauthorized access from other smart devices that use the same APP.

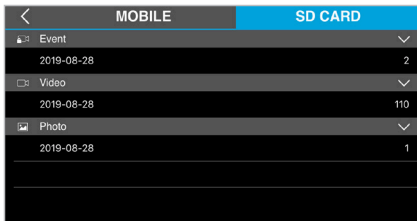

Gallery

Tap the 📁 icon on the main interface to enter the media gallery. Tap the **SD CARD** tap to access the media files stored in the MicroSD card. Scroll down the list to select the file arranging from newest to oldest.

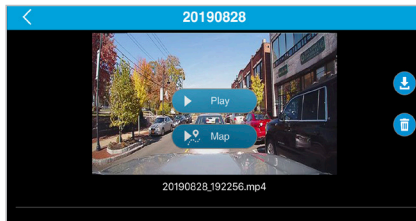

SD CARD tap

Tap the 📁 icon to download the selected file into your smartphone, or tap the 🗑 icon to delete the file from the MicroSD card.

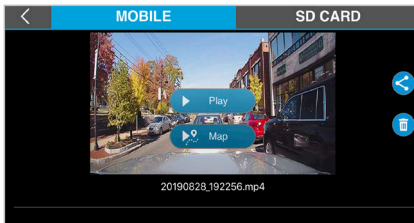

MOBILE tap

Tap the **MOBILE** tap to access the downloaded files in your smartphone. You can manage files even if your phone is not auto sync with the Dash Cam. Tap the back arrow icon to share the selected file, or tap the trash icon to delete the file.

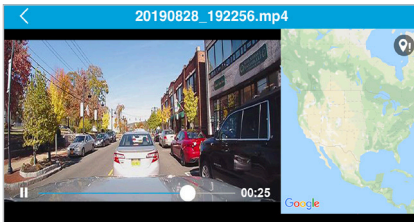

GPS Signal Status 1

This status indicates GPS receiver is waiting for GPS signal when the footage is recorded. GPS trip data will resume once it picks up the signal. If this status appeared repeatedly please call our technical support to assist in troubleshooting.

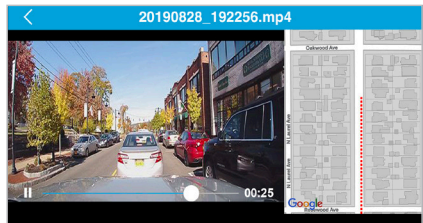

GPS Information

You can tap **Play** to play the footage or tap **Map** to show GPS location while the footage is playing back.

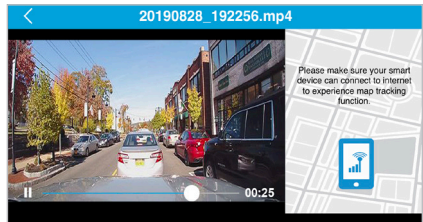

GPS Signal Status 2

This status indicates map tracking is not working. Mobile data must be turned on for map tracking to process.

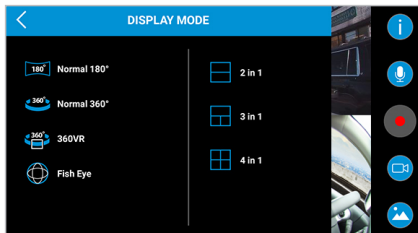

Display Mode

- Select from 7 different viewing modes.

 Normal 360°

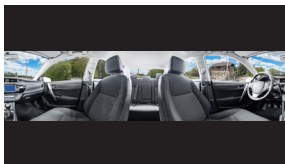

 Fish Eye

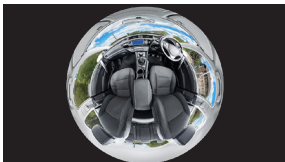

 2 in 1



 Normal 180°



Rotate the Camera Lens into front facing when switching to Normal 180° viewing mode.

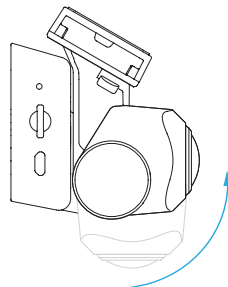

 360° VR

When 360° VR viewing mode is selected, user can change the field of view by swiping on the screen.



 3 in 1



 4 in 1



15. LIVE STREAMING

The 2K 360 Dash Cam Pro offers live streaming capability. With internet connection, you can easily share your Dash Cam footage on Facebook or YouTube anywhere you go.

Before enabling live stream feature, please make sure the following steps are checked:

- Allow the Type S Drive APP to use your smartphone's location service.
- Allow the Type S Drive APP to access your microphone.
- Choose the viewing mode you preferred before you go live, you cannot change the viewing mode during a live stream section.

Live stream on YouTube



1. Tap the **LIVE LIVE** icon.

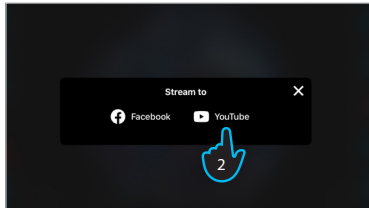

2. Tap to choose YouTube.

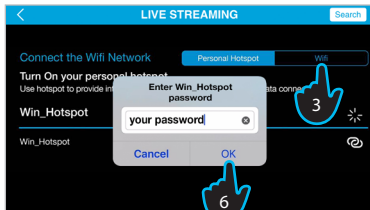

3. Choose WiFi or mobile hotspot connection.*

*If you choose to connect to your mobile hotspot, please locate it and follow step 4-6. Otherwise, if you choose to connect to WiFi, then choose your SSID and enter the password, and then follow step 7.

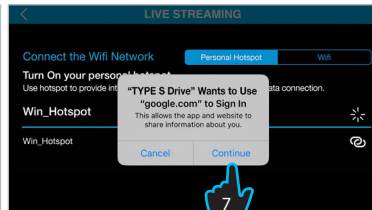
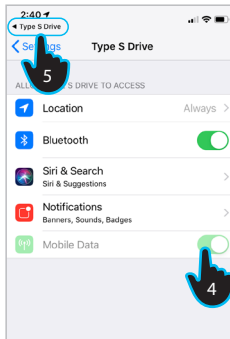

4. Turn on Mobile Data and turn it on again.

5. Tap **Type S Drive** icon to return to the APP.

6. Type in the password of your mobile hotspot and tap **OK**.

7. Tap **Continue** to sign in your Google account.

8

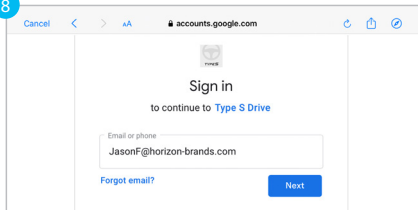

8. Sign in the Google account using the email address that is associated with your YouTube account* and tap **Next**.

***Note:** Make sure you complete the following before reaching step 8:

- i. You have already signed up for your YouTube account and have created your YouTube channel.
- ii. Confirm that your account is verified and that you have no live stream restrictions in the last 90 days.

Visit support.google.com/youtube/answer/2474026 for all questions related to Go Live on YouTube.

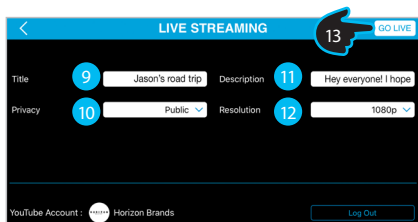

9. Create a title.
10. Select a privacy setting. Tap the down arrow under "Privacy" and choose **Public**, **Private**, or **Unlisted**.
11. Add a description.
12. Choose resolution of your live stream. Tap the down arrow under "Resolution" and choose **720p**, or **1080p**.
13. Tap **GO LIVE** to start the live stream.



Notes:

- The Dash Cam will stop recording during a live stream section.

- The Dash Cam will export full, uncropped image during a 360° VR mode live stream section on the Facebook and YouTube APP, which causes a black area to appear on the top of the image.

Live Stream View



-  Switch to Facebook/YouTube APP
-  Stop Live Stream
-  Home Screen

View live stream on YouTube APP

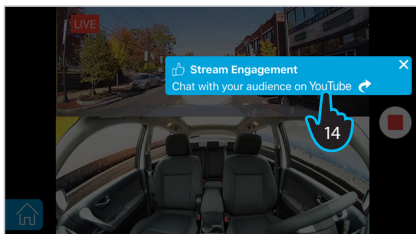

14. Tap the  icon from the Live Stream view and then tap **Stream Engagement** to switch to the YouTube APP.

15. In the YouTube APP, tab **Type S Drive** icon to return to the Type S Drive APP.

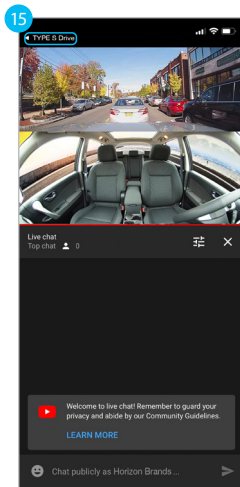

16. Press the  button on the Dash Cam to end the live streaming.

Live stream on Facebook



1. Tap the  **LIVE** icon.

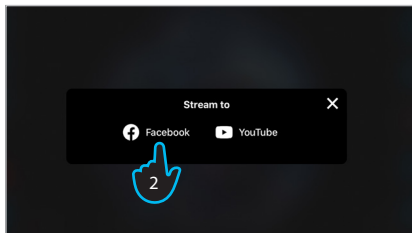

2. Tap to choose Facebook.

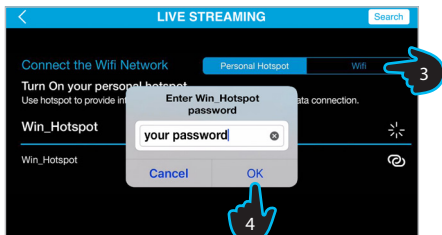

3. Choose WiFi or mobile hotspot.
*Please refer to page 18 on how to connect.
4. Type in the password and tap **OK**.

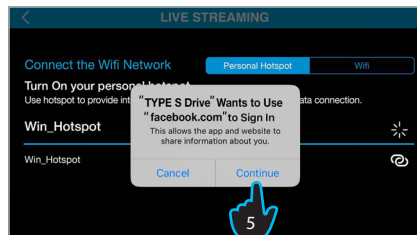

5. Tap **Continue** to sign in your Facebook account.

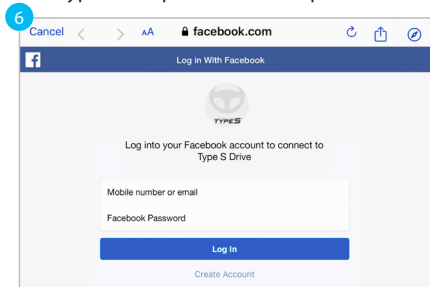

6. Log in your Facebook account.

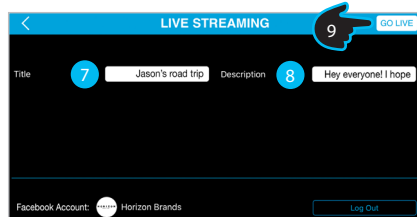
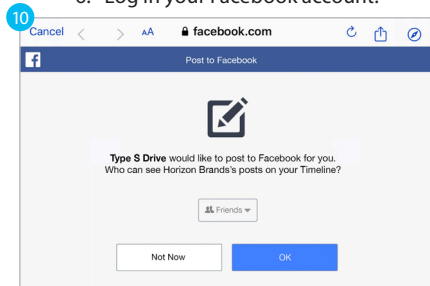



7. Create a title.
8. Add a discription.
9. Tap **GO LIVE**.
10. Choose who can see your posts online and tap **OK** to broadcast.

Notes:

- 1) Facebook allows user to broadcast up to 4 hours on each live streaming section.
- 2) Facebook APP supports 360° VR viewing mode. If you are viewing the 360° broadcast just tilt your phone or drag on the screen to spin around. However, it is not available if you watch Facebook Live on a web browser.

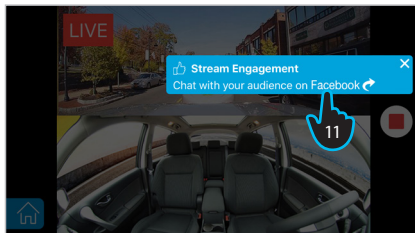
View live stream on Facebook APP



11. Tap the  icon from the Live Stream view and then tap **Stream Engagement** to switch to the Facebook APP.

12. In the Facebook APP, tap **Type S Drive** icon to return to the Type S Drive APP.

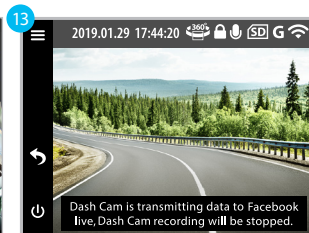
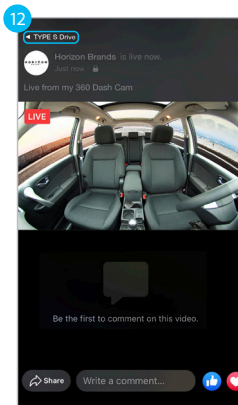

13. Press the  button on the Dash Cam to end the live streaming.

16. DASH CAM CONFIGURATION & MENU SETTINGS

Apply configuration and settings to the Dash Cam using the 4 function buttons. Refer to the screen display on the right for the buttons and their corresponding functions under Video Mode.

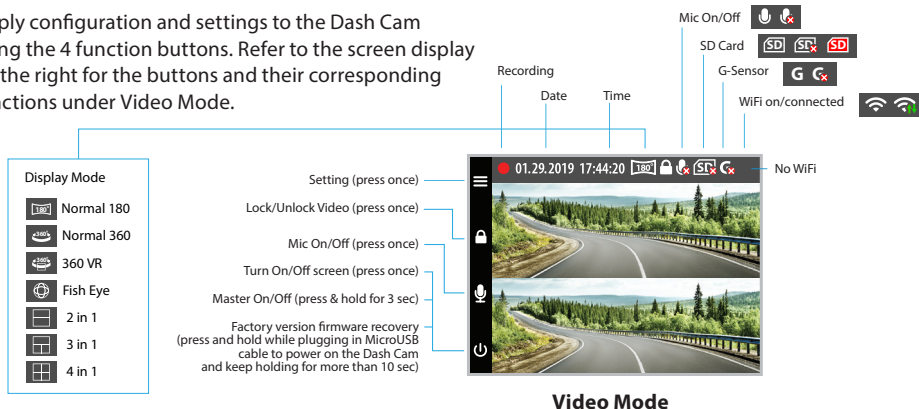

Refer to the screen display below for the buttons and their corresponding functions under Camera Mode.

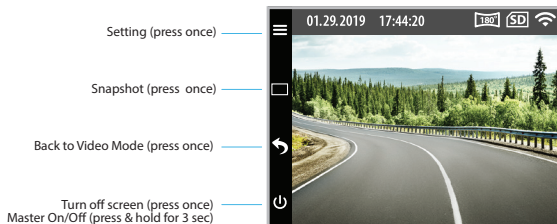
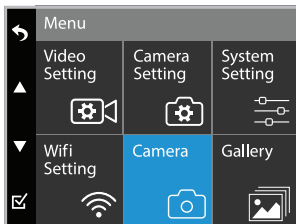

Camera Mode

Video Setting

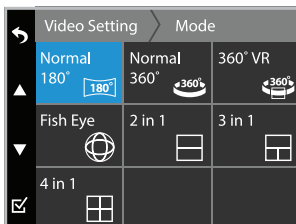

Video Mode

Mode	Resolution	Frame Per Second (fps)
Normal 180°	1920 X 1080	30
Normal 360°	3840 X 768	30
360° VR (Time stamp on video playback will appear distorted)	2784 X 1392	30
Fish Eye	1856 X 1856	30
2 in 1	2048 X 1536	30
3 in 1	2048 X 1536	30
4 in 1	2048 X 1536	30

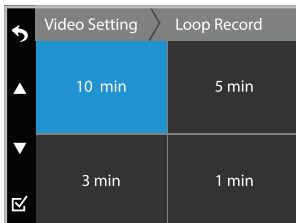

Loop Record

Select the duration of each recorded footage.

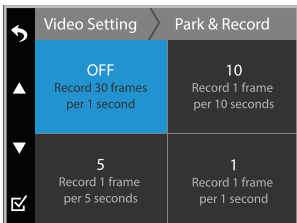

Park & Record

Mode	Behavior
Off	Without time-lapse record, captures 30 frames per 1 second.
10	Time-lapse record, captures 1 frame per 10 seconds.
5	Time-lapse record, captures 1 frame per 5 seconds.
1	Time-lapse record, captures 1 frame per 1 second.

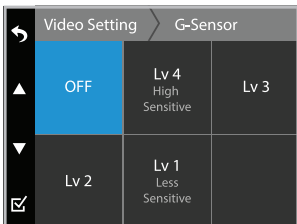

G-Sensor

When G-Sensor detects a sudden movement such as an impact or collision, it will trigger an Event Recording and the footage will be stored inside the Event folder inside the MicroSD card. The level of sensitivity can be adjusted from Lv.1-4 as Lv.1 to be the less sensitive and Lv.4 as most sensitive. Turn OFF to disable G-Sensor function.

Note: G-Sensor is set to Lv.4 automatically when the Dash Cam is recording in Park & Record Mode.

Camera Setting

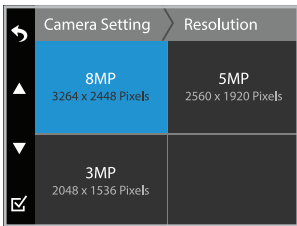

Resolution

Resolution (Megapixel)	Size 4:3
8MP	3264x2448
5MP	2560x1920
3MP	2048x1536

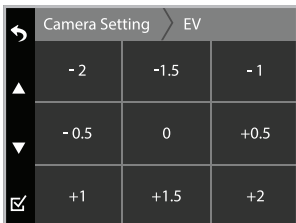

Exposure Level (EV)

- Adjust the exposure level for different lighting conditions.
- Values range from -2 to +2.

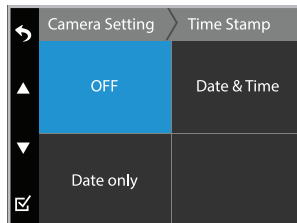

Time Stamp

Turn ON/ OFF the time stamp shown on recorded media files.

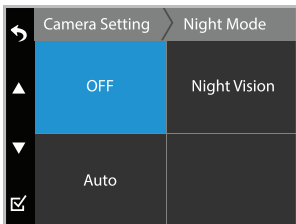

Night Mode

Select the Night Vision Mode. The light sensor detects and switches to Night Vision Mode automatically if the Dash Cam is recording in low-light environments. Display visual will be brightened and in black and white under Night Vision Mode.

Select the Auto Mode. The light sensor detects and switches to Auto Mode automatically if the Dash Cam is recording in low-light environments. Display visual will be brightened and in color under Auto Mode.

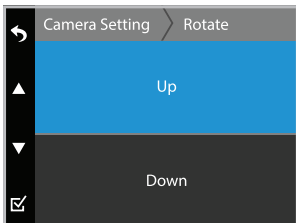

Rotate

The default camera view is set to Down. Select rotate if your mounting angle requires you to flip the Dash Cam by 180 degrees.

System Setting

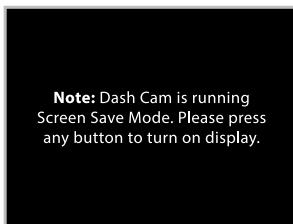
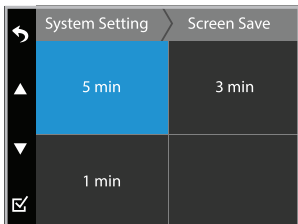

Screen Save

Turn off the display after a chosen period of inactivity. To turn on the display press any of the function buttons.

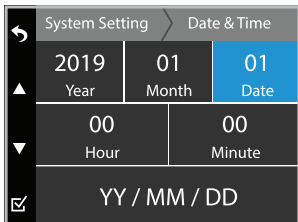

Date & Time

Set the date and time before using the 2K 360 Dash Cam Pro as this will affect the time stamp on all recorded media files.

Note: Press the ▲ and ▼ button to select different time stamp combinations: DD/MM/YY, YY/MM/DD, MM/DD/YY.

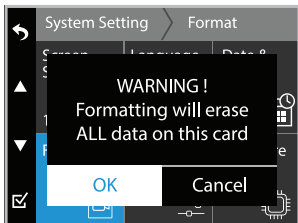

Format

Erase all data on the MicroSD card.

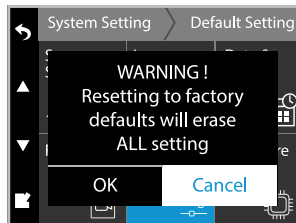

Default Setting

To reset all settings to their defaults.

17. VIEWING AND MANAGING MEDIA FILES USING A COMPUTER

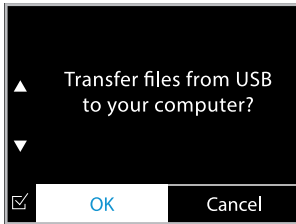
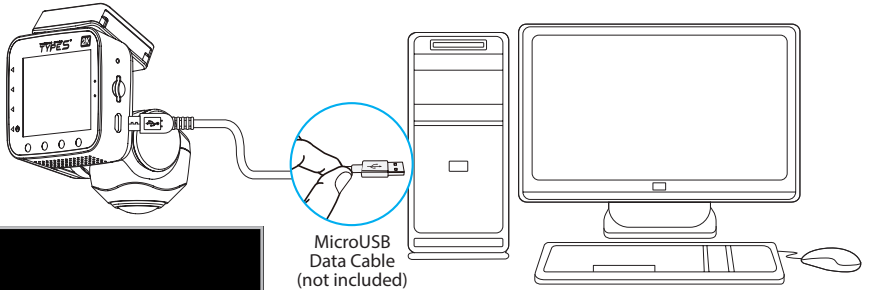

Once the Dash Cam is connected to a computer with a MicroUSB data cable (not included), this screen will show up on the Dash Cam. Select OK to proceed.

The Dash Cam will function as a card reader for the computer, and it will appear as a new USB drive. User can manage files in the MicroUSB card directly from the computer.

Note: The Dash Cam will stop recording when it is connected to a computer.

You can enjoy the 360° VR experience using the Microsoft Movies & TV app for PC or VLC Media Player for Mac. Visit the link below to download the latest version of VLC Media Player.

www.videolan.org/vlc/

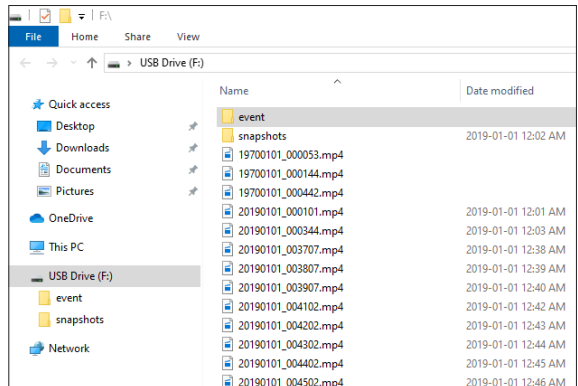

18. SAFETY INFORMATION

IMPORTANT SAFETY INSTRUCTIONS

1. SAVE THESE INSTRUCTIONS– This manual contains important safety and operating instructions of 12V Car charger for Model BT530025.
2. Before using the product, read all instructions and cautionary markings.
3. Do not expose car charger to rain, moisture, or snow.
4. Use of an attachment not recommended or sold by the product manufacturer may result in a risk of fire, electric shock, or injury to persons.
5. To reduce risk of damage to cigarette lighter connector and cord, pull by cigarette lighter connector rather than cord when disconnecting car charger.
6. Make sure cord is located so that it will not be stepped on, tripped over, or otherwise subjected to damage or stress.
7. Do not operate car charger with damaged cord or cigarette lighter connector – replace it immediately.
8. Do not operate car charger if it has received a sharp blow, been dropped, or otherwise damaged in any way; take it to a qualified serviceperson.
9. Do not disassemble car charger; take it to a qualified serviceperson when service or repair is required. Incorrect reassembly may result in a risk of electric shock or fire.
10. To reduce risk of electric shock, unplug charger before attempting any maintenance or cleaning. Turning off controls will not reduce this risk.

WARNING: A failure to read and follow these warnings and instructions may result in a serious accident, including damaged property or a serious injury, including loss of life.

- The 2K 360 Dash Cam Pro is designed as an aid to the driver in detecting large stationary objects to help avoid damaging the vehicle. However, you, the driver, must use it safely and properly. Use of the 2K 360 Dash Cam Pro is not a substitute for safe, proper and legal driving.
- Never depend on the 2K 360 Dash Cam Pro entirely when driving. The image on the screen is different from actual conditions. Objects viewed in the Dash Monitor differ from actual distance because a wide-angle lens is used.
- The 2K 360 Dash Cam Pro “night vision” feature that is high performance brightness with colorful image is an aid to a driver but is limited. Always use your own eyes to confirm the vehicle’s surroundings, as the displayed image may be faint or dark, distorted, or not entirely visible.

- Always check behind and all around the vehicle visually with mirrors before proceeding.
- The area displayed by the 2K 360 Dash Cam Pro is limited. The 2K 360 Dash Cam Pro does not display objects that are out of the Camera's field of view. The area displayed on the screen may vary according to vehicle orientation or road conditions.
 - Be sure to check the Camera's position and mounting angle before each use.
 - Do not strike the 2K 360 Dash Cam Pro. It is a precision instrument. Otherwise, it may malfunction or cause damage resulting in a fire or an electric shock.
 - This product will only provide images of items that are within the field of view of the 2K 360 Dash Cam Pro. Thus, it is imperative that the 2K 360 Dash Cam Pro should be kept clean and unobstructed.
 - Adhere to all applicable traffic laws and motor vehicle regulations applicable to the device.
 - Consult local laws and regulations for any restrictions on installation or use.
 - Never allow children to play with the device. Small parts may be a choking hazard.
 - There is a plastic cover over the 2K 360 Dash Cam Pro. Do not scratch the cover when cleaning dirt or snow from the cover.
 - If the temperature changes rapidly, the system may not operate normally.
 - When strong light directly enters a camera, objects may not be displayed clearly.
 - The screen may flicker under fluorescent light.
 - The colors of objects on the Dash Monitor may differ somewhat from those of the actual object.
 - Do not use alcohol, benzene or thinner to clean the Camera. This will cause discoloration. To clean the Camera, wipe with a clean cloth dampened with mild cleaner diluted with water and then wipe with a dry cloth.
 - Will work up to 3 Meters/ 9.84 Feet.

SAFETY AROUND AND BEHIND OTHER VEHICLES

Using a 2K 360 Dash Cam Pro is not enough to completely overcome a vehicle's blind spot. Many preventable injuries and deaths occur in driveways or parking lots when drivers do not see children, pets, or others near their vehicles. Here are a few safety tips that will help you to avoid a back-over accident:

- Walk completely around your vehicle before getting in. Check for kids, toys, and pets before

entering the vehicle and starting the engine.

- Know where children are. Have children stand in a place where they are in full view.
- Be aware of young children. Young children are small and hard to see.
- Parents, caregivers and all adults need to be vigilant in supervising children, especially when children are in the yard, driveway or parking lot playing near parked cars.
- Roll down your window so you will be able to hear what is happening outside your vehicle.
- Owners of SUVs, trucks, and vans need to take extra care to avoid hitting or running over a child.
- Teach children to move away from a vehicle whenever it is started.

19. MAINTENANCE & WARRANTY

CLEANING

- If dirt, rain or snow attaches to the Camera, the Monitor may not clearly display objects. If water droplets, snow or mud adhere to the Camera lens, rinse with water and wipe with a dry cloth.
- Do not use alcohol, benzene or thinner to clean the Camera. This will cause discoloration. To clean the Camera, wipe with a clean cloth dampened with mild cleaner diluted with water and then wipe with a dry cloth.

WARRANTY

- **TYPE S**

LIMITED WARRANTY

Type S warrants, to the original purchaser, that its products are free from defects in material and workmanship for 1 year from the date of original purchase. Where permitted by law, Type S liability shall be limited to that set forth in this limited express warranty. This limited express warranty shall be the exclusive remedy of the purchaser and Type S makes no other warranty of any kind aside from the limited express warranty stated above.

Note: Warranty only applies for North American customers of purchases made in North America.

- **CONDITIONS OF WARRANTY**

If during the 1 year warranty period your new product is found to be defective, Type S will repair such defect, or replace the product, without charge for parts or labor subject to the following conditions:

1. All repairs must be performed by Type S.
2. All warranty claims must be accompanied by a copy of the sales receipt or bill of sale.
3. The equipment must not have been altered or damaged through negligence, accident, improper operation, or failure to follow the product instructions for installation, use, or care.
4. The replacement of parts is excluded from the warranty when replacement is necessary due to normal wear and tear.
5. Repair or replacement parts supplied by Type S under this warranty are protected only for the unexpired portion of the original warranty.
6. This is a "repair or replace" warranty only, and does not cover the costs incurred for the installation, removal or reinstallation of the product, or damage to any mobile phone device or vehicle.

OWNER'S RESPONSIBILITIES:

Type S will make every effort to provide warranty service within a reasonable period of time.

SHOULD YOU HAVE ANY QUESTIONS ABOUT SERVICE RECEIVED OR IF YOU WOULD LIKE ASSISTANCE IN OBTAINING SERVICE, PLEASE CALL TOLL FREE 1.866.294.9244 DURING REGULAR BUSINESS HOURS MONDAY THROUGH FRIDAY 8:00 AM TO 5:00PM.

Note: Toll Free # is for North America Customers ONLY. See Customer service section for customer contact numbers for other regions/offices.

For customer service and technical support, please call us at 1.866.294.9244. If at that time it is determined that a replacement unit is needed, the support representative will issue a Return Authorization and instruct on how to get a new unit.

Type S makes no other warranty of any kind aside from the limited express warranty stated herein.

DISCLAIMER OF WARRANTIES, INCLUDING WARRANTY OF MERCHANTABILITY AND WARRANTY OF FITNESS FOR PARTICULAR PURPOSE: EXCEPT AS SPECIFICALLY SET FORTH HEREIN, NO WARRANTY OR REPRESENTATION, EXPRESS OR IMPLIED, IS MADE AS TO THE SOLAR WIRELESS BACKUP CAMERA. EXCEPT AS EXPRESSLY SET FORTH HEREIN, TYPE S AND/OR ITS AFFILIATES EXPRESSLY DISCLAIMS, WITHOUT LIMITATION, ANY STATUTORY WARRANTIES AND ALL IMPLIED WARRANTIES, INCLUDING ANY IMPLIED WARRANTY OF MERCHANTABILITY OR FITNESS FOR A PARTICULAR PURPOSE.

Type S and/or its affiliates do not guarantee or promise that the user of 2K 360 Dash Cam Pro will not be in an accident or otherwise not collide with an object and/or person. Our 2K 360 Dash Cam Pro is not intended in any way to be a substitute for careful and cautious driving or for the consistent adherence to all applicable traffic laws and motor vehicle safety regulations.

The 2K 360 Dash Cam Pro is not intended to be a substitute for rearview mirrors or for any other motor vehicle equipment mandated by law. Even when properly installed, our 2K 360 Dash Cam Pro has a limited field of vision and does not provide a comprehensive view of the rear area of the vehicle.

Type S and/or its affiliates are not responsible for a user's intended or actual use of the 2K 360 Dash Cam Pro. In no event shall Type S and/or its affiliates have any liability for any losses (whether direct or indirect, in contract, tort or otherwise) incurred in connection with the 2K 360 Dash Cam Pro, including but not limited to damaged property, personal injury and/or loss of life. Neither shall Type S and/or its affiliates have any liability for any decision, action or inaction taken by any person in reliance on the 2K 360 Dash Cam Pro, or for any delays, inaccuracies and / or errors in connection with the 2K 360 Dash Cam Pro and its functioning.

Type S and/or its affiliates shall have no responsibility or liability for damage and/or injury resulting from accidents occurring with vehicles having the installed, and Type S and/or its affiliates, the manufacturer, distributor and seller shall not be liable for any injury, loss or damage, incidental or consequential, arising out of the use or intended use of the product.

20. GENERAL INFORMATION

CUSTOMER SERVICE/CONTACT

IF YOU ARE EXPERIENCING ANY ISSUES WITH THE PRODUCT DURING OPERATION, DO NOT RETURN THE PRODUCT TO THE STORE. CONTACT TYPE S DIRECTLY FOR INSTRUCTIONS ON HOW TO RETURN/ EXCHANGE THE PRODUCT.

FCC / IC Compliance Statement:

This device complies with Part 15 of the FCC rules and Industry Canada license-exempt RSS standard(s). Operation is subject to the following two conditions: (1) This device may not cause harmful interference, and (2) this device must accept any interference received, including interference that may cause undesired operation.

Warning: Changes or modifications to this unit not expressly approved by the party responsible for compliance could void the user's authority to operate the equipment. The manufacturer is not responsible for any radio or TV interference caused by unauthorized modifications or change to this equipment. Such modifications or change could void the user's authority to operate the equipment.

Note: This equipment has been tested and found to comply with the limits for Class B digital device, pursuant to part 15 of the FCC Rules. These limits are designed to provide reasonable protection against harmful interference in a residential installation. This equipment generates, uses and can radiate radio frequency energy and, if not installed and used in accordance with the instructions, may cause harmful interference to radio or television reception, which can be determined by turning the equipment off and on, the user is encouraged to try to correct the interference by one or more of the following measures:

- Reorient or relocate the receiving antenna.
- Increase the separation between the equipment and the receiver.
- Connect the equipment into an outlet on a circuit different from that to which the receiver is connected.
- Consult the dealer or an experienced radio/TV technician for help.

The device has been evaluated to meet general RF exposure requirement.
To maintain compliance with FCC/IC's RF exposure guidelines, this equipment should be installed and operated with a minimum distance of 20cm between the radiator and your body.

CAN ICES-3 (B)/NMB-3(B)

2K 360 Dash Cam Pro with HDR
BT530025

Responsible Party:

TYPE S

2975 Red Hill Ave., Ste. 100,
Costa Mesa, CA 92626, U.S.A.

Tel: 1.866.294.9244

3M VHB™ is a trademark of 3M Company.

Android is a trademark of Google Inc.

iPhone, iPad, Mac and iPod touch are trademarks of Apple Inc.

Microsoft is a registered trademark of the Microsoft Corporation.

VideoLAN, VLC, VLC media player and x264 are trademarks internationally registered by the VideoLAN non-profit organization.

The Facebook logo is a trademark of Facebook, Inc.

YouTube and the YouTube logo are registered trademarks of Google Inc.

TYPE S

A Horizon Brands Company
2975 Red Hill Ave., Ste. 100, Costa Mesa, CA 92626, U.S.A.
1.866.294.9244 | info@typesauto.com
©2021 TYPE S. All rights reserved.

www.typesauto.com

ML-530025_V1