

TOURING ITEMS
TYPES[®]

JUMP STARTER & POWER BANK



ITM. / ART. 1509971
WP ITM. AC532632

User Manual

IMPORTANT, RETAIN FOR FUTURE REFERENCE: READ CAREFULLY

BC

TECHNICAL SPECIFICATIONS:

Product Dimensions:	6.2 x 3.6 x 1.2 in (158 x 91.5 x 33 mm)
Product Weight:	0.9 lbs (410g)
Internal Battery:	Lithium-Ion
Battery Capacity:	29.6 Wh
Input (Micro USB):	5V 2A
Input (USB-C):	5V 2A / 9V 2A
USB-A Output:	5V 2.4A / 9V 2A
USB-C Output:	5V 3A / 9V 2A
Jump Start Current:	400A
Operating Temperature:	-20°C ~ 34°C (-4°F ~ 93°F)
Storage Temperature:	-20°C ~ 40°C (-4°F ~ 104°F) Avg. Temp.
Charging Temperature:	0°C ~ 34°C (32°F ~ 93°F)
Charging Time:	4-5 hours
Housing Protection:	IP64 Splash-Resistant (with Ports Covered)

FEATURE OVERVIEW :

1. Safe & Smart Polarity & Overcharge Protection
2. Jumper Cables Port
3. LED Flashlight, Strobe & Hazard Modes
4. Hazard Light
5. USB-A Output
6. Micro USB Input
7. USB-C Output / Input
8. LCD Display
9. Mode Button: Power, LED & Language Selection
10. Positive Clamp (Red)
11. Negative Clamp (Black)
12. Polarity Circuit Protection Box with Built-in LED Indicators

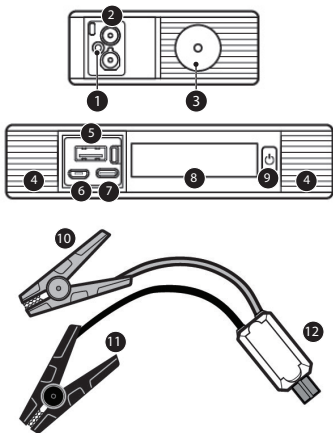

WARNING:

INSTRUCTIONS PERTAINING TO RISK OF FIRE, ELECTRIC SHOCK, OR INJURY TO PERSONS

- Always wear safety glasses when jump starting a battery (to protect your eyes), and gloves when handling a battery (to protect your hands).
- When jump starting a vehicle please ensure that the gray plug is securely fitted into the jump starter socket on the jump starter.
- Ensure the battery clamps are connected correctly, and the connectors are free from rust and dirt.
- Do not allow this product to become wet. Exposure to excessive moisture will damage the unit.
- Do not immerse the product in water.
- Do not operate the product in explosive atmospheres, such as in the presence of flammable liquid, gas or dust.
- Do not modify or disassemble this product.
- Do not store in locations where the temperature may exceed 104°F (40°C).
- Charge only using the charger provided.
- Under extreme heat conditions, battery leakage may occur. Avoid contact with your skin. In case of skin or eye contact, rinse immediately with clean water and seek medical attention.
- If battery leakage occurs, take it to your local battery recycling center for disposal. Do not attempt to use.
- This car jump starter is for use with 12V vehicles only. Using on non-12V vehicles may cause serious damage to the vehicle, jump starter, or injury to the user. Refer to the owner's manual for the vehicle if you are uncertain what voltage the vehicle runs on.

BATTERY DISPOSAL

The battery is self-contained and not consumer replaceable. The battery must be disposed of properly when it no longer holds a charge. Proper charging practices will increase the life of the product. For information on battery recycling, call toll-free 800-822-8837.

For information regarding air travel safety with batteries please check the U.S. Department of Transportation prior to travel at:
<http://phmsa.dot.gov/safetravel/batteries>
or contact your airline if traveling from a country outside the U.S.

Note: The Car Jump Starter gives 29.6 watt hours of power.

WARNING CONT.:

IMPORTANT SAFETY INSTRUCTIONS

WARNING - When using this product, basic precautions should always be followed, including the following:

- a) Read all the instructions before using the product.
- b) To reduce the risk of injury, close supervision is necessary when the product is used near children. Children should not operate this device unless under strict supervision by a person responsible for their safety.
- c) Do not put fingers or hands into the product.
- d) Do not use any attachment that is not sold by jump starter manufacturer which may result in a risk of fire, electric shock, or injury to persons.
- e) To reduce risk of damage to the electric plug and cord, pull the plug rather than the cord when disconnecting the jump starter.
- f) Do not use a battery pack or appliance that is damaged or modified. Damaged or modified batteries may exhibit unpredictable behavior resulting in fire, explosion or risk of injury.
- g) Do not operate the jump starter with a damaged cord or plug, or a damaged output cable.
- h) Do not disassemble the jump starter; take it to a qualified service person when service or repair is required. Incorrect reassembly may result in a risk of fire or electric shock.
- i) To reduce the risk of electric shock, unplug the jump starter from the outlet before attempting any instructed servicing.
- j) **WARNING - RISK OF EXPLOSIVE GASES.**
 - 1) **WORKING IN VICINITY OF A LEAD ACID BATTERY IS DANGEROUS. BATTERIES GENERATE EXPLOSIVE GASES DURING NORMAL BATTERY OPERATION. FOR THIS REASON, IT IS OF THE UTMOST IMPORTANCE THAT YOU FOLLOW THE INSTRUCTIONS EACH TIME YOU USE THE JUMP STARTER.**
 - 2) To reduce risk of battery explosion, follow these instructions and those published by battery manufacturer and manufacturer of any equipment you intend to use in vicinity of the battery. Review cautionary marking on these products and on engine.
- k) The device shall be stored indoors and protected from the elements;
- l) The unit shall not be charged outdoors;
- m) When in use, steps should be taken to reduce the exposure to rain, sleet, snow, and the like.
- n) **PERSONAL PRECAUTIONS**
 - 1) Consider having someone close enough by to come to your aid when you work near a lead-acid battery.
 - 2) Have plenty of fresh water and soap nearby in case battery acid contacts skin, clothing, or eyes.

WARNING CONT.:

- 3) Wear complete eye protection and clothing protection. Avoid touching eyes while working with battery.
 - 4) If battery acid contacts skin or clothing, wash immediately with soap and water. If acid enters eye, immediately flood eye with running cold water for at least 10 minutes and get medical attention immediately.
 - 5) NEVER smoke or allow a spark or flame within the vicinity of battery or engine.
 - 6) Be extra cautious to reduce risk of dropping a metal tool onto battery. It might spark or short-circuit battery or other electrical part that may cause explosion.
 - 7) Remove personal metal items such as rings, bracelets, necklaces, and watches when working with a lead-acid battery. A lead-acid battery can produce a short-circuit current high enough to weld a ring or the like to metal, causing a severe burn.
- o) When charging the internal battery, work in a well ventilated area and do not restrict ventilation in any way.
 - p) Under abusive conditions, liquid may be ejected from the battery; avoid contact. If contact accidentally occurs, flush with water. If liquid contacts eyes, additionally seek medical help. Liquid ejected from the battery may cause irritation or burns.
 - q) Do not expose a jump starter to fire or excessive temperature. Exposure to fire or temperature above 130°C (266°F) may cause explosion.
 - r) Have servicing performed by a qualified repair person using only identical replacement parts. This will ensure that the safety of the product is maintained.
 - s) Attach output cables to a battery and chassis as indicated below. Never allow the output clamps to touch one another.
 - t) Dropping, hitting, or other excessive amounts of force to the Jump Starter may damage the unit (external and internal), which may result in loss of operation, electrical fire, or cause other serious damage.
 - u) Do not overcharge the internal battery or short circuit output connector.
 - v) This product is suitable for use in home, office, household workshop or garage. Do not operate in rough environment such as repair facility.

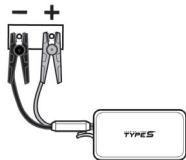

WARNING: This Jump Starter is only intended to jump start 12V cars, trucks, boats, or motorcycles with an internal combustion engine and single lead-acid battery systems. Do not use this device to jump start batteries outside of these four types of vehicles; doing so may cause a fire or other serious injuries. Refer to the user manual for additional safety information.

SAVE THESE INSTRUCTIONS

PACKAGE CONTENTS:

Jump Starter
Power Bank



Storage Case



12V USB Charger &
Micro USB
Charging Cable



Safe & Smart
Jumper Cables

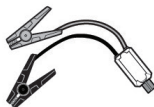

CHECKING THE POWER LEVEL





Press  to check the battery status of the Jump Starter.

When charging, the battery indicator will glow. Jump Starter is fully charged when the battery indicator is solid and reads 100%.

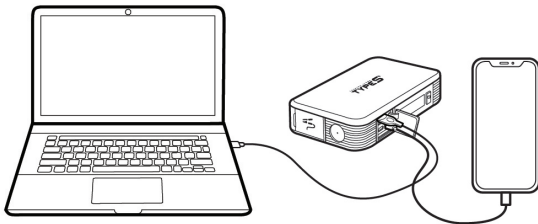
CHARGING YOUR MOBILE DEVICES:



We recommend using the original charging cable that came with your mobile device, or an approved cable certified by the mobile device manufacturer. Two mobile devices can be charged at the same time by utilizing both USB-A and USB-C Output ports. To begin charging, press  once. While charging, press  to check the battery capacity.

CHARGING THE JUMP STARTER:

At home:

Micro USB Cable

1. Plug bundled Micro USB Charging Cable into a USB-A port on a computer or 2A USB wall adapter (not included).
2. Connect the Micro USB Charging Cable into the Micro USB Charge Input Port on the Jump Starter.
3. Disconnect the Jump Starter when it is fully charged. Store the Jump Starter in a safe place when not in use.

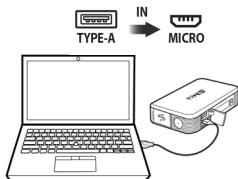

USB-A to USB-C Cable /USB-C to USB-C Cable (cables not included)

1. Plug one end of USB-C Charging Cable into a USB-A / USB-C port on a 18W (or above) wall adapter (not included).
2. Connect the other end of USB-C Charging Cable into the USB-C Charging Input Port on the Jump Starter.
3. Disconnect the Jump Starter when it is fully charged. Store the Jump Starter in a safe place when not in use.

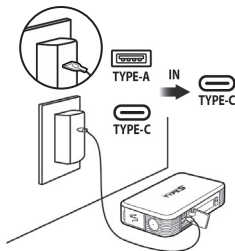

In Car:

1. Plug bundled Micro USB Charging Cable into bundled 12V USB Charger then connect it to 12V socket in vehicle.
2. Connect the Micro USB Charging Cable into the Micro USB Charge Input Port on the Jump Starter.
3. Disconnect the Jump Starter when it is fully charged. Store the Jump Starter in a safe place when not in use.

NOTE: In order to reduce the risk of fire or electric shock, an adapter shall be chosen that is suitable for the application and is certified as a Class 2 or LPS power supply or power adapter.

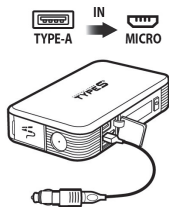

NOTE: Fully charge the Jump Starter upon receipt. Check battery status periodically and recharge every 2-3 months and after every use to maintain the efficiency and to prolong the life of the internal battery.

JUMP STARTING:

⚠ BEFORE YOU JUMP START!

Before you attempt to jump start your vehicle, ensure your vehicle is in Park. Unplug all USB charging cables. Ensure manual transmission vehicles are in Neutral with the Emergency Brake engaged.

The Cable Clamps are color-coded, **RED** for POSITIVE (+) and **BLACK** for NEGATIVE (-). DO NOT mix up the cables or allow the metal ends to touch together because this may damage the battery, charging system and/or electronics on a vehicle.

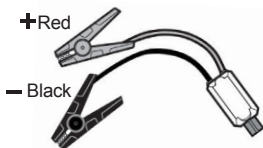

Locate the vehicle battery and follow the steps below. We recommend jump starting when the Jump Starter battery level is > 50%.

INTELLI-STEP SMART DISPLAY:

The Jump Starter is programmed to display step-by-step instructions to Jump Start your vehicle. When the Jump Starter is powered on, plug the Jumper Cables into the Jumper Cables Port and follow the progressive prompts on the LCD Display. The detailed steps are provided in the next section for reference.

JUMP STARTING:

1. Press the  to power on the Jump Starter; ensure the power level is 50% or higher.

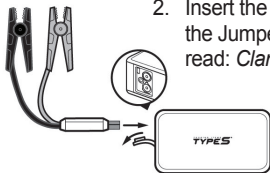

2. Insert the **GRAY** end of the Jumper Cables into the Jumper Cables Port. The LCD Display will read: *Clamp cables to battery.*

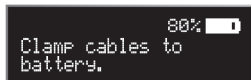

JUMP STARTING CONT.:

3. Connect the **RED** clamp to the POSITIVE (+) post on the car battery. The POSITIVE battery post will be slightly larger than the NEGATIVE post, and will be marked with a PLUS (+) sign. There may also be a **RED** plastic protective cover over the positive battery post.

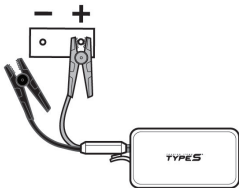

4. Connect the **BLACK** clamp to the NEGATIVE (-) post on the car battery. The NEGATIVE will be marked with a MINUS (-) sign. There may be a **BLACK** plastic protective cover over the negative battery post.

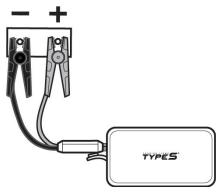

NOTE: Do not connect the **RED** clamp (+) and the **BLACK** clamp (-) at the same time. Connect the **RED** clamp first, then the **BLACK** clamp.

CAUTION: DO NOT lean directly over the battery while making jumper connections.

5. Check the LED status on the Polarity Circuit Protection Box. Proceed to the next step unless the LED is flashing **RED** and BEEPING. Reference Polarity Protection Circuit Status chart in the next section.
6. Once the clamps are properly connected to the vehicle battery, the LCD Display will read: *Ready, Start vehicle ignition.* You have 90 seconds to start your vehicle before the Jump Starter shuts off in order to prevent the vehicle battery from reverse charging the unit.

80% 
Ready, Start vehicle
ignition.

NOTE: If vehicle does not crank, or cranks very slowly, wiggle the cable clamps on the vehicle battery to ensure they are making good contact. Wait 60 seconds before trying to jump start your vehicle again. **Each new jump start attempt requires disconnection of both clamps from the vehicle battery and reconnection.**

JUMP STARTING CONT.:

The engine should start if there are no other problems (such as a bad starter or ignition circuit problem). Do not attempt to jump start the vehicle more than 3 times with the Jump Starter. If the vehicle fails to start after 3 attempts, it is likely due to alternative reasons that should be checked by an auto mechanic.

7. When the engine starts, the LED on the Polarity Circuit Protection Box will blink **RED** and beep. The LCD Display will also read: *Successful jump, unplug cables.*



8. Disconnect the cables from your vehicle within 30 seconds. First remove the **RED/POSITIVE (+)** clamp and then the **BLACK/NEGATIVE (-)** clamp.
9. Do not allow the metal ends of the jumper cable clamps to touch each other, or the **RED** clamp to touch anything metal on the car. Now unplug the **GRAY** end of the jumper cables from the Jump Starter. This will reset the jumper cables. In 30-seconds the Jump Starter will power off automatically.
10. Keep the engine running for 20 to 30 minutes, or drive the car to recharge the battery.

NOTE: If the engine dies shortly after it has been jump started, or as soon as the jumper cables are disconnected, it probably means the vehicle charging system is not working (bad alternator, voltage regulator, wiring problem, or loose/ dirty battery cables). Please seek professional help from an auto mechanic to find the root cause of the problem. The Jump Starter may not work correctly for vehicles that require remote battery jumper locations (e.g.: battery located in trunk or other location). Please consult the owner's manual for your vehicle.

JUMP STARTING CONT.:













Polarity Protection Circuit Status

Status (Light & Sound Indicator)			Status Meaning
Red Light	Green Light	Sound	
○	●	None	The car battery is ready for jump start
●	○	None	The Jump Starter needs to be charged
☀	☀	None	The car battery is ready for jump start. If the indicator doesn't turn solid Green, the car battery voltage is higher than the Jump Starter. You can still jump start your battery, but may need to charge your Jump Starter.
☀	○	Beeping	Disconnect the jumper cables from the car battery and Jump Starter. Either the car jump start is complete or there is a connection problem.
●	●	None	This status shows after 90 seconds time out. Disconnect the jumper cables from the car battery and Jump Starter to reset. Reconnect the jumper cables to jump start the vehicle.
○	○	None	Please contact TYPE S for troubleshooting





● Solid LED On ☀ Flashing LED ○ LED Off





Message on LCD Screen	Message Meaning
Low Power, charge at least 50%	Jump Starter battery below 50%
Battery Protected, Unplug, Start over	Wrong connection
Device is too hot, Cool before use	Temperature of Jump Starter is above 131°F / 55°C

LANGUAGE SELECTION:

Function	Action	Remarks
Turn on the Jump Starter	Press the 	
Switch language to Spanish	Press and hold  for 5 seconds until the word "English" is shown on the LCD screen, then press  once to enter Spanish mode. Press  twice to confirm.	Remain in Spanish mode if product is idle for 5 seconds
Switch language to French	Press  once while in Spanish mode. Press  twice to confirm.	Remain in French mode if product is idle for 5 seconds
Switch language to Japanese	Press  once while in French mode. Press  twice to confirm.	Remain in Japanese mode if product is idle for 5 seconds
Switch language to Korean	Press  once while in Japanese mode. Press  twice to confirm.	Remain in Korean mode if product is idle for 5 seconds
Switch language to English	Press  once while in Korean mode. Press  twice to confirm.	Remain in English mode if product is idle for 5 seconds

HAZARD LIGHT / FLASHLIGHT:

Hazard Light - Red Light	Press  twice
Strobe Light	Press  once while in red light mode
Hazard Light	Press  once while in strobe light mode
Turn Off	Press  once while in hazard light mode / Press  twice

Flashlight - Spotlight	Press and hold  for three seconds
Strobe Light	Press  once while in spotlight mode
Hazard Light	Press  once while in strobe light mode
Turn Off	Press  once while in hazard light mode / Press and hold  for three seconds

* Instruction messages on the LCD screen can be turned on/off by pressing  for 10 seconds.

WARRANTY:

TYPE S

LIMITED WARRANTY

TYPE S warrants, to the original purchaser, that its products are free from defects in material and workmanship for 1 year from the date of original purchase. Where permitted by law, TYPE S's liability shall be limited to that set forth in this limited express warranty. This limited express warranty shall be the exclusive remedy of the purchaser and TYPE S makes no other warranty of any kind aside from the limited express warranty stated above.

NOTE: Warranty only applies for North American customers of purchases made in North America.

CONDITIONS OF WARRANTY

If during the 1 year warranty period your new product is found to be defective, TYPE S will repair such defect, or replace the product, without charge for parts or labor subject to the following conditions:

1. All repairs must be performed by TYPE S.
2. All warranty claims must be accompanied by a copy of the sales receipt or bill of sale.
3. The equipment must not have been altered or damaged through negligence, accident, improper operation, or failure to follow the product instructions for installation, use, or care.
4. The replacement of parts is excluded from the warranty when replacement is necessary due to normal wear and tear.
5. Repair or replacement parts supplied by TYPE S under this warranty are protected only for the unexpired portion of the original warranty.
6. This is a "repair or replace" warranty only, and does not cover the costs incurred for the installation, removal or reinstallation of the product, or damage to any mobile phone, electronic device or vehicle.

WARRANTY CONT.:

OWNER'S RESPONSIBILITIES:

TYPE S will make every effort to provide warranty service within a reasonable period of time. SHOULD YOU HAVE ANY QUESTIONS ABOUT SERVICE RECEIVED OR IF YOU WOULD LIKE ASSISTANCE IN OBTAINING SERVICE, PLEASE CALL TOLL FREE 1.866.294.9244 DURING REGULAR BUSINESS HOURS, MONDAY THROUGH FRIDAY 8:00 AM TO 5:00 PM (Pacific Standard Time). For customer service and technical support, please call us at 1.866.294.9244 (English only) or email us at info@typesauto.com. If at that time it is determined that a replacement unit is needed, the support representative will issue a Return Authorization and instruct on how to get a new unit. TYPE S makes no other warranty of any kind aside from the limited express warranty stated herein.

NOTE: Toll-free number is for North American customers ONLY.

DISCLAIMER OF WARRANTIES, INCLUDING WARRANTY OF MERCHANTABILITY AND WARRANTY OF FITNESS FOR PARTICULAR PURPOSE: EXCEPT AS SPECIFICALLY SET FORTH HEREIN, NO WARRANTY OR REPRESENTATION, EXPRESS OR IMPLIED, IS MADE AS TO THE CAR JUMP STARTER. TYPE S AND/OR ITS AFFILIATES EXPRESSLY DISCLAIMS, WITHOUT LIMITATION, ANY STATUTORY WARRANTIES AND ALL IMPLIED WARRANTIES, INCLUDING ANY IMPLIED WARRANTY OF MERCHANTABILITY OR FITNESS FOR A PARTICULAR PURPOSE.

TYPE S and/or its affiliates are not responsible for a user's intended or actual use of the Car Jump Starter. In no event shall TYPE S and/or its affiliates have any liability for any losses (whether direct or indirect, in contract, tort or otherwise) incurred in connection with the Car Jump Starter, including but not limited to damaged property, personal injury and/or loss of life. Neither shall TYPE S and/or its affiliates have any liability for any decision, action taken based on relying on the stability or performance of the Car Jump Starter. TYPE S and/or its affiliates, the manufacturer, distributor and seller shall not be liable for any injury, loss or damage, incidental or consequential, arising out of the use or intended use of the product.

WARRANTY CONT.:



FCC Compliance Statement:

Jump Starter & Power Bank

Model: AC532632

Responsible Party:

TYPE S

2975 Red Hill Ave., Ste. 100, Costa Mesa, CA 92626

Tel: 1-866-294-9244

This device complies with Part 15 of the FCC Rules.

Operation is subject to the following two conditions:

- (1) This device may not cause harmful interference, and
- (2) This device must accept any interference received, including interference that may cause undesired operation.

Warning: Changes or modifications to this unit not expressly approved by the party responsible for compliance could void the user's authority to operate the equipment.

The manufacturer is not responsible for any radio or TV interference caused by unauthorized modifications or change to this equipment. Such modifications or change could void the user's authority to operate the equipment.

NOTE: This equipment has been tested and found to comply with the limits for Class B digital device, pursuant to Part 15 of the FCC Rules. These limits are designed to provide reasonable protection against harmful interference in a residential installation. This equipment generates, uses and can radiate radio frequency energy and, if not installed and used in accordance with the instructions, may cause harmful interference to radio or television reception, which can be determined by turning the equipment off and on, the user is encouraged to try to correct the interference by one or more of the following measures:

- Reorient or relocate the receiving antenna.
- Increase the separation between the equipment and the receiver.
- Connect the equipment into an outlet on a circuit different from that to which the receiver is connected.
- Consult the dealer or an experienced radio/TV technician for help.

TROUBLESHOOTING:

Issue	Cause	Remedy
Cannot jump start	Wrong clamp connection	Make sure to clamp the RED jumper cable to the POSITIVE (+) post on the car battery. And BLACK jumper cable to NEGATIVE (-) post or car interior. Refer to Page 8 for details.
	90-Second timer to jump start has expired.	Jump Starter timed out. Disconnect the cables from the vehicle battery and reconnect.
	Low battery status	Recharge the unit via USB cable until at least 50% charge.
LED light on the clamp box keeps flashing	Protection circuit is working	Refer to the status table on the indicator box or page 11 of the manual.
Hazard light or flashlight does not turn on	Low battery	Recharge the unit via USB cable.
	The unit is charging	As a safety precaution, the hazard light or flashlight will not work while the unit is charging. Please unplug the unit from charging or wait until the unit finishes charging before using the light.



A Horizon Brands Company

2975 Red Hill Ave., Ste. 100, Costa Mesa, CA 92626

Mon - Fri, 8AM - 5PM (Pacific Time)

Tel: 1-866-294-9244 (English only) | info@typesauto.com

©2021 TYPE S. All rights reserved.

www.typesauto.com

Made in China

ML-532632_V1