

TOURING ITEMS
TYPES[®]

1080P REAR CAMERA

WP ITM. BT532838
Care & Use Instructions



**Important, retain for future reference:
Read carefully**

TABLE OF CONTENTS

1. Introduction	3
2. Package Contents	4
3. Product Specifications	5
4. Product Dimension	5
5. Installation	6
6. Safety Information	9
7. Maintenance & Warranty	12
8. General Information	14

1. INTRODUCTION





Please read all of the installation instructions carefully before installing the product. Improper installation will void the manufacturer's warranty. The installation instructions do not apply to all types of vehicles, and are written as guidelines to assist in installing the system.

Consult an experienced technician if you are not comfortable installing the product. You can also contact TYPE S at **866.294.9244** to speak to one of our installation specialists if you have any specific questions regarding this product.

BEFORE using the 1080P Rear Camera, please read the safety information provided in this user manual. ALWAYS use the product as outlined in this user manual.

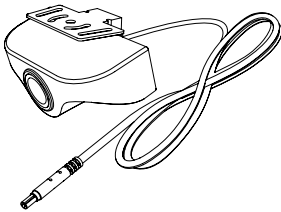
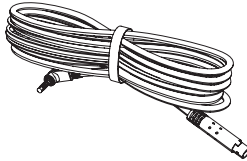
Please make sure to read and understand all local laws and regulations regarding cameras and their use in a vehicle. Laws vary by state.

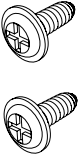
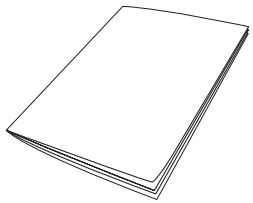
2. PACKAGE CONTENTS

<p>1.</p> 	<p>2.</p> 	<p>3.</p> 
<p>4.</p> 	<p>5.</p> 	<p>6.</p> 

1. 1 x 1080P Rear Camera

2. 1 x 6m Extended Cable

3. 1 x 3M VHB™ Double-sided Tape

4. 2 x Screw (L 11.3mm x Dia 3mm)

5. 1 x Instruction Manual

6. 1 x Warranty Card

3. PRODUCT SPECIFICATIONS

Resolution:	1080P / 30FPS
Operating Voltage:	DC 5V
Viewing Angle:	90°
Operating Temperature:	14°F~140°F (-10°C~60°C)
Camera Water Resistance:	IP65 Rating

4. PRODUCT DIMENSION

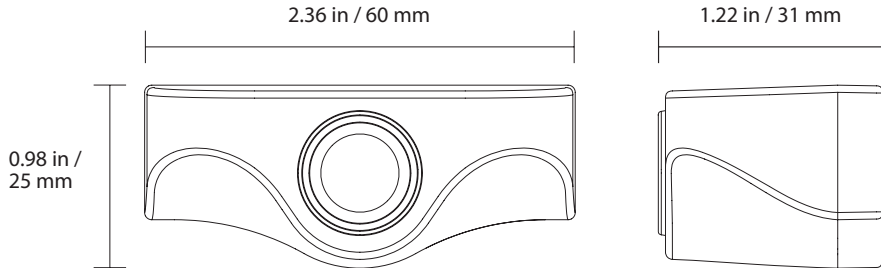

5. INSTALLATION

Follow these steps and mount the rear cam near the license plate. Route and hide the power cable in your vehicle.

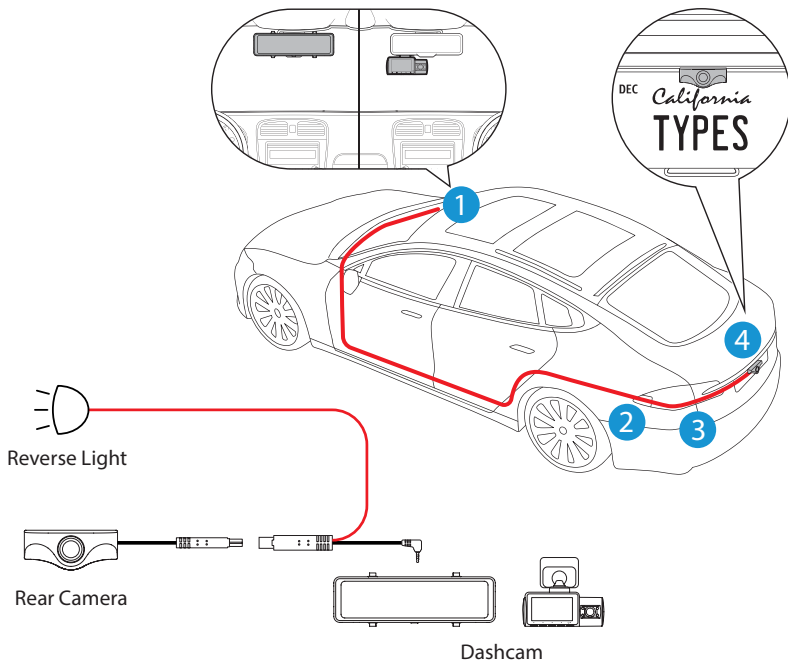

- 1 Plug the metal pin end of the cable into the AV-IN port on the dashcam.

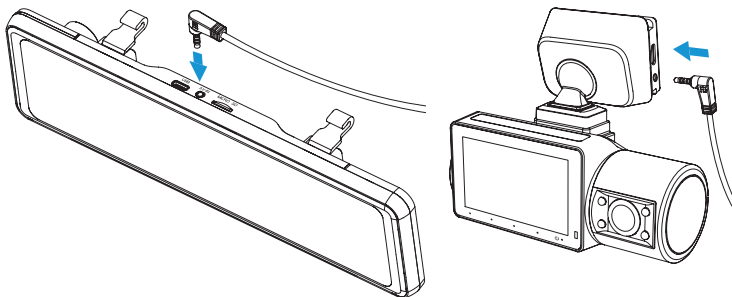

- 2 Hardwire the red cable to one of the reverse light.

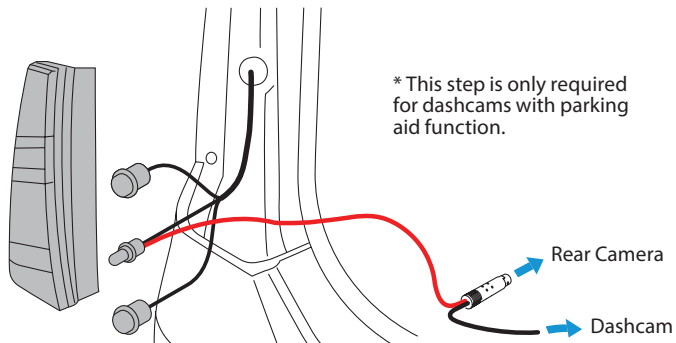

- 3 Connect the Extension Cable to the rear cam.

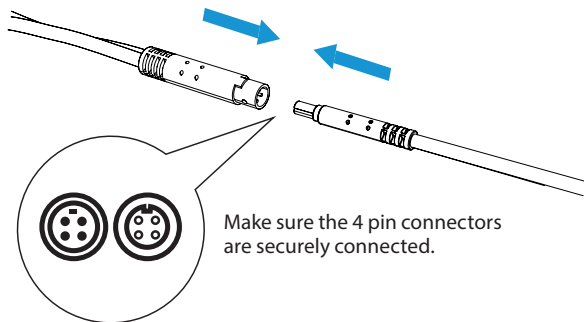

- 4 Mount the rear cam near the license plate using either the screws or the 3M VHB™ Double Sided Tape. Adjust the camera to your desired angle.

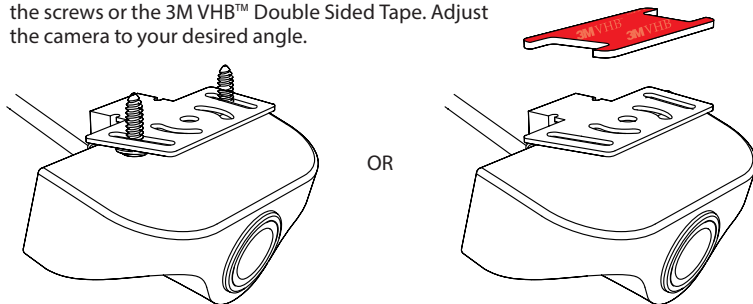

6. SAFETY INFORMATION

IMPORTANT SAFETY INSTRUCTIONS

1. SAVE THESE INSTRUCTIONS– This manual contains important safety and operating instructions for Model BT532838.
2. Before using the product, read all instructions and cautionary markings.
3. Use of an attachment not recommended or sold by the product manufacturer may result in a risk of fire, electric shock, or injury to persons.
4. Make sure cord is located so that it will not be stepped on, tripped over, or otherwise subjected to damage or stress.
5. To reduce risk of damage to the rear cam and cord, pull by the connector rather than cord when disconnecting the rear camera.
6. Do not operate the product if it has received a sharp blow, been dropped, or otherwise damaged in any way; take it to a qualified serviceperson.
7. Do not disassemble the product; take it to a qualified serviceperson when service or repair is required. Incorrect reassembly may result in a risk of electric shock or fire.
8. To reduce risk of electric shock, unplug the product before attempting any maintenance or cleaning. Turning off controls will not reduce this risk.

WARNING: A failure to read and follow these warnings and instructions may result in a serious accident, including damaged property or a serious injury, including loss of life.

- The rear camera is designed as an aid to the driver in detecting large stationary objects to help avoid damaging the vehicle. However, you, the driver, must use it safely and properly. Use of the rear camera is not a substitute for safe, proper and legal driving.
- Never back up while looking only at the rear camera image. You should always check behind and around the vehicle when backing up just as you would if the vehicle did not have the rear camera. Always make sure your intended path is clear. If you back up while looking only at the rear camera image, you may hit a vehicle, pedestrian, bicyclist, child, pet or other object resulting in injury or death. Always back up slowly.
- Never depend on the rear camera entirely when driving and backing up. The rear camera image is different

from actual conditions. Objects displayed by the rear camera differ from actual distance because a wide-angle lens is used.

- The area displayed by the rear camera is limited. The rear camera does not display objects that are close to or below the bumper, underneath the vehicle, or objects out of the rear camera's field of view. The area displayed on the screen may vary according to vehicle orientation or road conditions.
- Always check behind and all around the vehicle visually with mirrors before proceeding.
- Be sure to check the rear camera's position and mounting angle before each use.
- Make sure the trunk, hatch, or backdoor is completely and securely closed when backing up.
- If the back of the vehicle is hit, the position and mounting angle of the rear camera may change.
- When washing the vehicle with high pressure water, be sure not to spray it around the rear camera. Otherwise, water may enter the camera unit causing water condensation on the lens, a malfunction, fire or an electric shock.
- Do not strike the rear camera. It is a precision instrument. Otherwise, it may malfunction or cause damage resulting in a fire or an electric shock.
- This product will only provide images of items that are within the field of view of the rear camera. Thus, it is imperative that the rear camera should be kept clean and unobstructed, and should be mounted so that its field of view includes the entire area behind your vehicle.
- Adhere to all applicable traffic laws and motor vehicle regulations applicable to the device.
- Consult local laws and regulations for any restrictions on installation or use.
- Never allow children to play with the device. Small parts may be a choking hazard.
- If you replace the tires, the area displayed on the monitor may change and you may need to adjust the rear camera.
- There is a plastic cover over the rear camera. Do not scratch the cover when cleaning dirt or snow from the cover.
- The rear camera has a water resistant construction. Do not detach, disassemble or modify it. This may cause incorrect operation.
- Do not submerge rear camera in water, which can cause internal damage to the rear camera.
- If the temperature changes rapidly, the system may not operate normally.

- When strong light directly enters a rear camera, objects may not be displayed clearly.
- The screen may flicker under fluorescent light.
- The colors of objects on the rear view monitor may differ somewhat from those of the actual object.
- Do not use alcohol, benzene or thinner to clean the rear camera. This will cause discoloration. To clean the rear camera, wipe with a clean cloth dampened with mild cleaner diluted with water and then wipe with a dry cloth.
- ALWAYS engage Parking/Emergency/Hand Brakes of the vehicle when testing the system.

SAFETY AROUND AND BEHIND OTHER VEHICLES

Many preventable injuries and deaths occur in driveways or parking lots when drivers do not see children, pets, or others near their vehicles. Here are a few safety tips that will help you to avoid a back-over accident:

- Walk completely around your vehicle before getting in. Check for kids, toys, and pets before entering the vehicle and starting the engine.
- Know where children are. Have children stand in a place where they are in full view.
- Be aware of young children. Young children are small and hard to see.
- Parents, caregivers and all adults need to be vigilant in supervising children, especially when children are in the yard, driveway or parking lot playing near parked cars.
- Roll down your window so you will be able to hear what is happening outside your vehicle.
- Owners of SUVs, trucks, and vans need to take extra care to avoid hitting or running over a child.
- Teach children to move away from a vehicle whenever it is started.

7. MAINTENANCE & WARRANTY

CLEANING

- If water droplets, snow or mud adhere to the rear camera lens, rinse with water and wipe with a dry cloth.
- Do not use alcohol, benzene or thinner to clean the rear camera. This will cause discoloration. To clean the rear camera, wipe with a clean cloth dampened with mild cleaner diluted with water and then wipe with a dry cloth.

WARRANTY

- **TYPE S
LIMITED WARRANTY**

TYPE S warrants, to the original purchaser, that its products are free from defects in material and workmanship for 1 year from the date of original purchase. Where permitted by law, TYPE S liability shall be limited to that set forth in this limited express warranty. This limited express warranty shall be the exclusive remedy of the purchaser and TYPE S makes no other warranty of any kind aside from the limited express warranty stated above.

NOTE: Warranty only applies for North American customers of purchases made in North America.

CONDITIONS OF WARRANTY

If during the 1 year warranty period your new product is found to be defective, TYPE S will repair such defect, or replace the product, without charge for parts or labor subject to the following conditions:

1. All repairs must be performed by TYPE S.
2. All warranty claims must be accompanied by a copy of the sales receipt or bill of sale.
3. The equipment must not have been altered or damaged through negligence, accident, improper operation, or failure to follow the product instructions for installation, use, or care.
4. The replacement of parts is excluded from the warranty when replacement is necessary due to normal wear and tear.
5. Repair or replacement parts supplied by TYPE S under this warranty are protected only for the unexpired portion of the original warranty.

6. This is a “repair or replace” warranty only, and does not cover the costs incurred for the installation, removal or reinstallation of the product, or damage to any mobile phone device or vehicle.

OWNER’S RESPONSIBILITIES:

TYPE S will make every effort to provide warranty service within a reasonable period of time. SHOULD YOU HAVE ANY QUESTIONS ABOUT SERVICE RECEIVED OR IF YOU WOULD LIKE ASSISTANCE IN OBTAINING SERVICE, PLEASE CALL TOLL FREE 1.866.294.9244 DURING REGULAR BUSINESS HOURS MONDAY THROUGH FRIDAY 8:00 AM TO 5:00 PM.

NOTE: Toll Free # is for North America Customers ONLY. See Customer service section for customer contact numbers for other regions/offices.

For customer service and technical support, please call us at 1.866.294.9244. If at that time it is determined that a replacement unit is needed, the support representative will issue a Return Authorization and instruct on how to get a new unit. TYPE S makes no other warranty of any kind aside from the limited express warranty stated herein.

DISCLAIMER OF WARRANTIES, INCLUDING WARRANTY OF MERCHANTABILITY AND WARRANTY OF FITNESS FOR PARTICULAR PURPOSE: EXCEPT AS SPECIFICALLY SET FORTH HEREIN, NO WARRANTY OR REPRESENTATION, EXPRESS OR IMPLIED, IS MADE AS TO THE 1080P REAR CAMERA. EXCEPT AS EXPRESSLY SET FORTH HEREIN, TYPE S AND/OR ITS AFFILIATES EXPRESSLY DISCLAIMS, WITHOUT LIMITATION, ANY STATUTORY WARRANTIES AND ALL IMPLIED WARRANTIES, INCLUDING ANY IMPLIED WARRANTY OF MERCHANTABILITY OR FITNESS FOR A PARTICULAR PURPOSE.

TYPE S and/or its affiliates do not guarantee or promise that the user of rear camera will not be in an accident or otherwise not collide with an object and/or person. Our rear camera is not intended in any way to be a substitute for careful and cautious driving or for the consistent adherence to all applicable traffic laws and motor vehicle safety regulations.

The rear camera is not intended to be a substitute for rearview mirrors or for any other motor vehicle equipment mandated by law. Even when properly installed, our rear camera has a limited field of vision and does not provide a comprehensive view of the rear area of the vehicle. TYPE S and/or its affiliates are not responsible for a user's intended or actual use of the rear camera. In no event shall TYPE S and/or its affiliates have any liability for any losses (whether direct or indirect, in contract, tort or otherwise) incurred in connection with the rear camera, including but not limited to damaged property, personal injury and/or loss of life. Neither shall TYPE S and/or its affiliates have any liability for any decision, action or inaction taken by any person in reliance on the rear camera, or for any delays, inaccuracies and /or errors in connection with the rear camera and its functioning.

TYPE S and/or its affiliates shall have no responsibility or liability for damage and/or injury resulting from accidents occurring with vehicles having the installed, and TYPE S and/or its affiliates, the manufacturer, distributor and seller shall not be liable for any injury, loss or damage, incidental or consequential, arising out of the use or intended use of the product.

8. GENERAL INFORMATION

CUSTOMER SERVICE/CONTACT

IF YOU ARE EXPERIENCING ANY ISSUES WITH THE PRODUCT DURING OPERATION, DO NOT RETURN THE PRODUCT TO THE STORE. CONTACT TYPE S DIRECTLY FOR INSTRUCTIONS ON HOW TO RETURN/EXCHANGE THE PRODUCT.

FCC Compliance Statement:

This device complies with Part 15 of the FCC rules. Operation is subject to the following two conditions: (1) This device may not cause harmful interference, and (2) this device must accept any interference received, including interference that may cause undesired operation.

WARNING: Changes or modifications to this unit not expressly approved by the party responsible for compliance

could void the user's authority to operate the equipment. The manufacturer is not responsible for any radio or TV interference caused by unauthorized modifications or change to this equipment. Such modifications or change could void the user's authority to operate the equipment.

NOTE: This equipment has been tested and found to comply with the limits for a Class B digital device, pursuant to part 15 of the FCC Rules. These limits are designed to provide reasonable protection against harmful interference in a residential installation. This equipment generates uses and can radiate radio frequency energy and, if not installed and used in accordance with the instructions, may cause harmful interference to radio communications. However, there is no guarantee that interference will not occur in a particular installation. If this equipment does cause harmful interference to radio or television reception, which can be determined by turning the equipment off and on, the user is encouraged to try to correct the interference by one or more of the following measures:

- Reorient or relocate the receiving antenna.
- Increase the separation between the equipment and the receiver.
- Connect the equipment into an outlet on a circuit different from that to which the receiver is connected.
- Consult the dealer or an experienced radio/TV technician for help.

1080P Rear Camera

BT532838

Responsible Party:

TYPE S

2975 Red Hill Ave., Ste. 100,
Costa Mesa, CA 92626, U.S.A.

Tel: 1-866-294-9244

3M VHB™ is a trademark of 3M Company.

REGISTERED TRADEMARK
TYPES

A Horizon Brands Company
2975 Red Hill Ave., Ste. 100, Costa Mesa, CA 92626, U.S.A.
1.866.294.9244 | info@typesauto.com
©2022 TYPE S. All rights reserved.

www.typesauto.com

ML-532838_V1