

SECTION A-A
SCALE 1 : 3

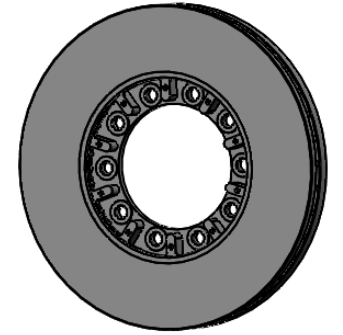

Drawn By: AD	Description: Disc Rotor
Date: 13/02/15	Part No: BD8438
Revision: Customer	Material: QT500

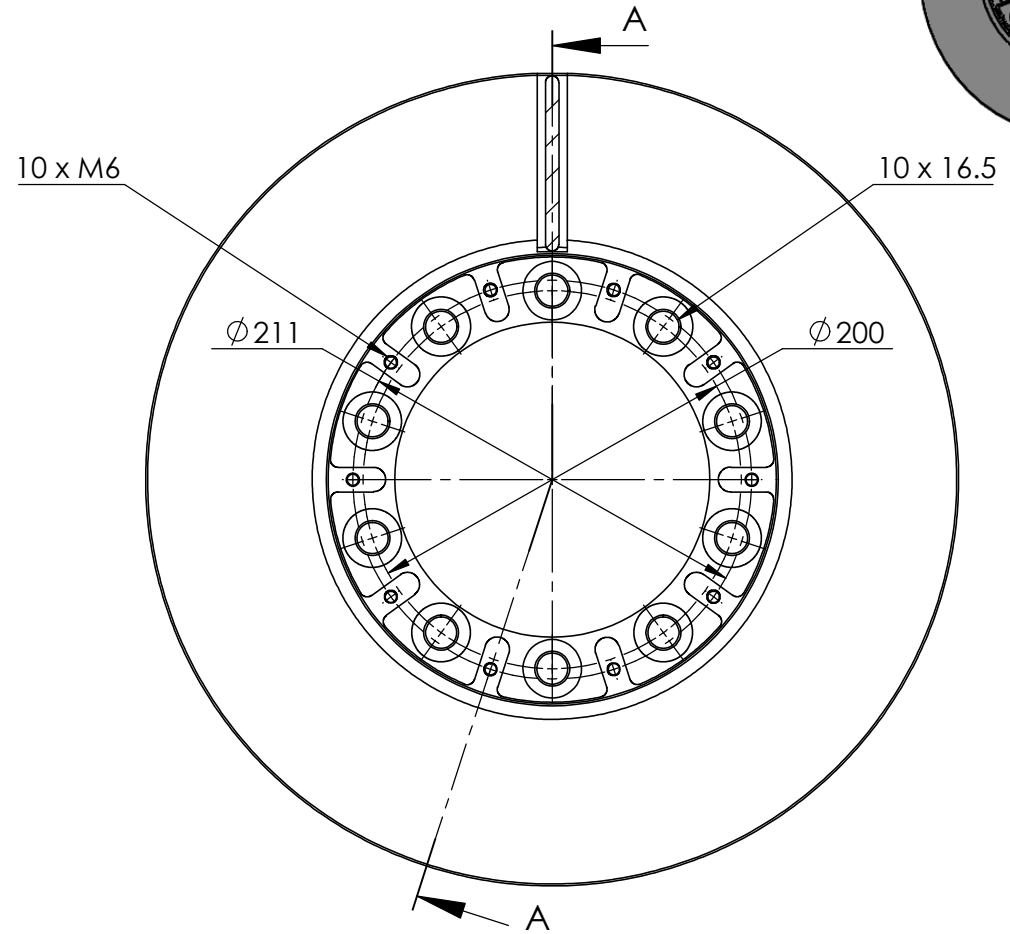