

Ω omega

8500

METAL DETECTOR

OWNER'S MANUAL

If you do not have prior experience with a metal detector, we strongly recommend you:

- 1) **Adjust the Sensitivity to a low setting in the event of false signals.** Always begin use at a reduced sensitivity level. Expect chatter or internal noise at high sensitivity.
- 2) **Do not use indoors.** This detector is for outdoor use only. Many household appliances emit electromagnetic energy, which can interfere with the detector. If conducting an indoor demonstration, turn the sensitivity down and keep the searchcoil away from appliances such as computers, televisions and microwave ovens. If your detector beeps erratically, turn off appliances and lights.

Also keep the searchcoil away from objects containing metal, such as floors and walls.

- 3) Use a 9-volt **ALKALINE** battery only. Do not use Heavy Duty Batteries.

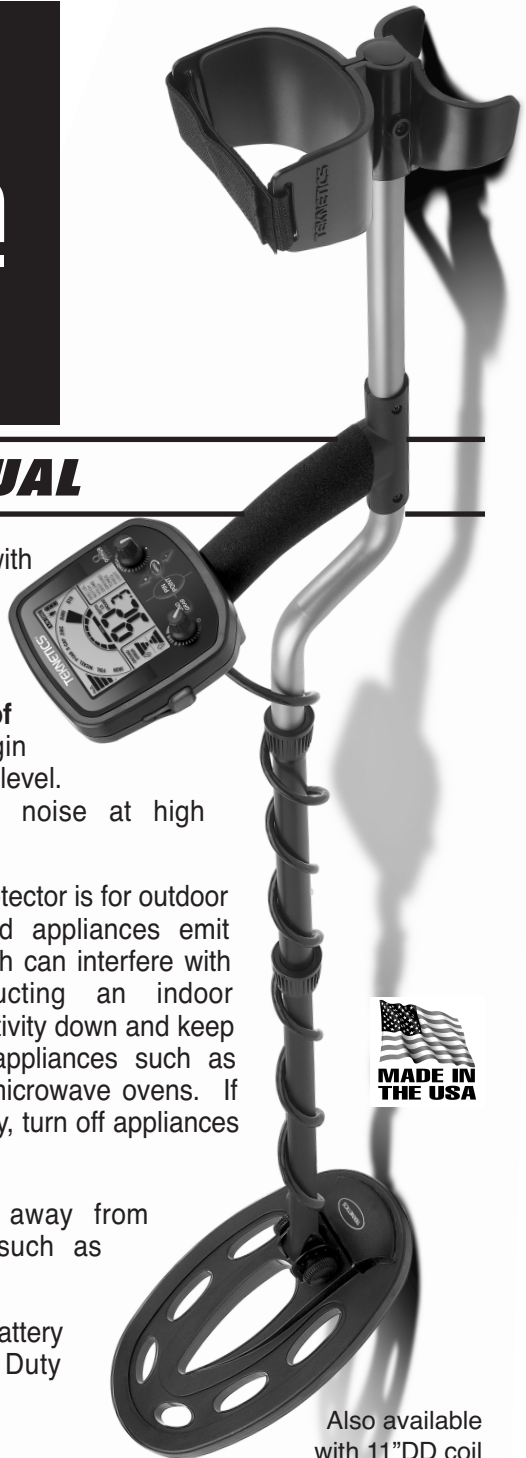

Also available
with 11"DD coil
(Item# OMEGA-11DD)

TABLE OF CONTENTS

Terminology	3
Assembly	4-5
Batteries	6
Quick-Start Demo	7-8
Basics Of Metal Detecting	9-10
Ground Minerals	9
Trash	9
Identifying Buried Objects	9
Size and Depth of Buried Objects	9
EMI	10
Headphones	10
Operation and Controls	11-14
Display and Controls	11
Control Knobs	12
On/Off/Gain	12
Disc/AM/Thresh	12
Separate Gain and Threshold Controls	13
Touchpad Controls	13
Ground Grab® Computerized Ground Balancing	13
Pinpoint	13
Pinpoint Retuning	14
Menu/Quick-Switch	14
Plus and Minus	14
Menu Items	15-18
Discrimination Level	15
Notch: Selective Target Inclusion or Exclusion	15
Volume	15
Notch Volume	16
Deep	16
Ground	16
Ground Grab Offset	17
Tones: Variable Tone Selection	17
d4 and d5 Tones	17
Frequency Shifting	18
Backlight	18
None Volatile Memory	18
Reset Factory (Factory Default)	18
Ground Balancing	19-20
Fe ₃ O ₄ Bar Graph	20
Ground Error	20-21
Depth and Target Display	22-24
Common Target Value Table	24
Search Techniques	25
Target Pinpoint	26
Code of Ethics	27
Warranty	27
Accessories	Back Cover

TERMINOLOGY

The following terms are used throughout the manual, and are standard terminology among detectorists.

ELIMINATION

Reference to a metal being "eliminated" means the detector will not emit a tone, nor light up an indicator, when a specified object passes through the coil's detection field.

DISCRIMINATION

When the detector emits different tones for different types of metals, and when the detector "eliminates" certain metals, we refer to this as the detector "discriminating" among different types of metals.

Discrimination is an important feature of professional metal detectors. Discrimination allows the user to ignore trash and otherwise undesirable objects.

RELIC

A relic is an object of interest by reason of its age or its association with the past. Many relics are made of iron, but can also be made of bronze or precious metals.

IRON

Iron is a common, low-grade metal that is an undesirable target in certain metal detecting applications. Examples of undesirable iron objects are old cans, pipes, bolts, and nails.

Sometimes, the desired target is made of iron. Property markers, for instance, contain iron. Valuable relics can also be composed of iron; cannon balls, old armaments, and parts of old structures and vehicles can also be composed of iron.

FERROUS

Metals which are made of, or contain, iron.

PINPOINTING

Pinpointing is the process of finding the exact location of a buried object. Long-buried metals can appear exactly like the surrounding soil, and can therefore be very hard to isolate from the soil.

PULL-TABS

Discarded pull-tabs from beverage containers are the most bothersome trash items for treasure hunters. They come in many different shapes and sizes. Pull-tabs can be eliminated from detection, but some other valuable objects can have a magnetic signature similar to pull-tabs, and will also be eliminated when discriminating out pull-tabs.

GROUND BALANCE

Ground Balancing is the ability of the detector to ignore, or "see through," the earth's naturally occurring minerals, and only sound a tone when a metal object is detected. This Detector incorporates proprietary circuitry to eliminate false signals from severe ground conditions.

ASSEMBLY

Adjusting the Armrest

The armrest may be moved forward or backward by removing the single screw and nut and then repositioning the 2-piece armrest. Users with shorter arms may find the armrest more comfortable in the forward position. In order to move the armrest backward, the plastic plug must be removed from the aluminum tube.

Armrest Strap

(Optional accessory)

The strap is available for purchase as a separate accessory. Some users prefer to use the strap when swinging the detector vigorously, in order to hold the detector secure against the arm.

The detector can also be used without the strap with no compromise to detector balance and stability under most conditions.

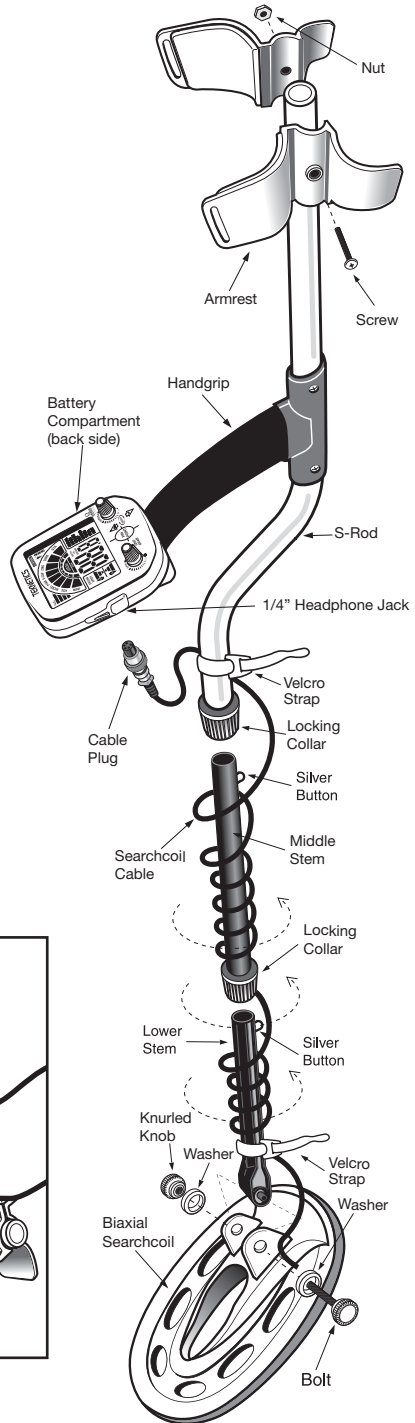
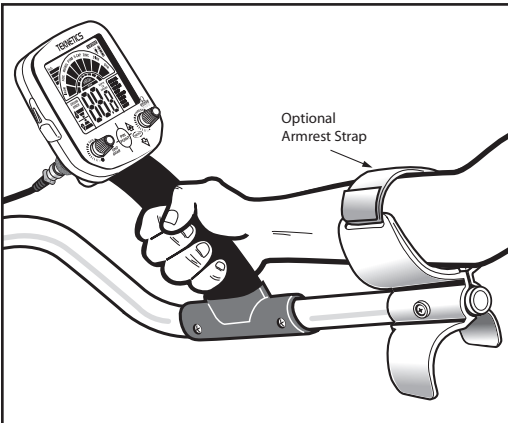

ASSEMBLY (continued)

Caution: Forcing in MIDDLE STEM with CAM LOCK raised may form a burr on cam lock. If this happens, remove burr with knife to allow insertion.

- 1 Position S-Rod upright.
- 2 Rotate the LOCKING COLLAR fully in the counterclockwise direction.
- 3 Insert your finger inside the tube and make sure the INTERNAL CAM LOCK is flush with the inside of the tube.

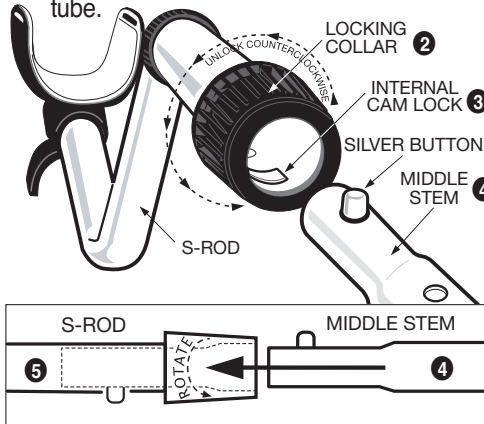

- 4 Insert the MIDDLE STEM into the S-ROD, with the SILVER BUTTON pointed upward.
- 5 Rotate the MIDDLE STEM until the SILVER BUTTON locates in the hole.
- 6 Twist the LOCKING COLLAR fully in the clockwise direction until it locks.
- 7 Repeat this process on the LOWER STEM.
- 8 Using the BOLT and KNURLED KNOB, attach the SEARCHCOIL to the LOWER STEM.
- 9 Adjust the LOWER STEM to a length that lets you maintain a comfortable upright posture, with your arm relaxed at your side, and the SEARCHCOIL parallel to the ground in front of you.
- 10 Wind the CABLE securely around the STEMS.
- 11 Connect CABLE PLUG to housing. Do not twist the Cable or Plug. Turn Locking Ring only. Use minimal finger pressure to start the threads. Do not cross-thread. When the Locking Ring is fully engaged over the threaded connector, give it a firm turn to make sure it is very tight. When the Locking Ring is fully engaged over the threaded connector, it may not cover all of the threads.
- 12 Tighten both LOCKING COLLARS.

* Note: Very tall users can purchase the optional Extended Lower Stem (TUBE5X), for extended reach.

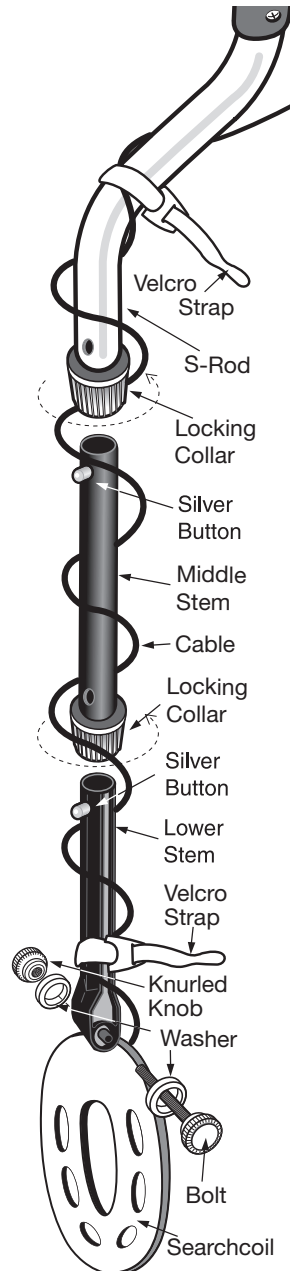

BATTERIES

The detector requires a single 9-volt **ALKALINE** battery (battery not included).

Do not use ordinary zinc carbon batteries.

Do not use “Heavy Duty” batteries.

Rechargeable batteries can also be used. If you wish to use rechargeable batteries, we recommend using a Nickel Metal Hydride rechargeable battery.

The battery compartment is located on the back side of the housing. Slide the battery door to the side and remove it to expose the battery compartment.

BATTERY LIFE

Expect 20 to 25 hours of life from a 9-volt alkaline battery, longer if using headphones. Rechargeable batteries provide about 8 hours of usage per charge. Backlight use decreases battery life with significant drain at maximum brightness.

SPEAKER VOLUME AND BATTERY CHARGE

You may notice the speaker volume drop while one battery segment is illuminated. With one segment flashing, low speaker volume will be very apparent.

BATTERY INDICATOR

The remaining battery life is proportional to the percentage of the battery icon illuminated.

After the battery indicator begins flashing, expect the detector to shut off within 10 minutes.

BATTERY DISPOSAL & RECYCLING

Alkaline batteries may be disposed of in a normal waste receptacle or recycled. Non-Alkaline batteries should be recycled. In the state of California all battery types must be recycled. Please refer to local municipalities for detailed disposal and recycling requirements.

QUICK-START DEMONSTRATION



I. Supplies Needed

- Nail
- Zinc Penny (dated after 1982)
- Nickel
- Quarter

II. Position the Detector

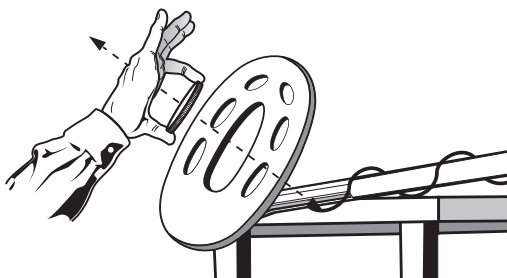
- Place the detector on a table with the searchcoil hanging over the edge. Or better, have a friend hold the detector, with the searchcoil off the ground.
- Keep the searchcoil away from walls, floors, and metal objects.
- Remove watches, rings, and jewelry.
- Turn off lights or appliances whose electromagnetic emissions may cause interference.
- Pivot the searchcoil back.



- III. Press and hold  then turn on detector with the GAIN knob. Release . Set GAIN at the 12:00 position.

- IV. Turn the THRESH knob all the way counterclockwise until it clicks.

V. Wave each object over the searchcoil.

- Notice a different tone for each object:

- Bass Tone:** Nail
Low Tone: Nickel and Zinc Penny
High Tone: Quarter

- Motion is required. Objects must be in motion over the searchcoil to be detected in this mode.

- VI. Press and release . DISC LVL will be activated.

Press  until the word "IRON" disappears from the screen. Make sure the word "FOIL" is still illuminated.



VII. Wave the nail over the searchcoil.

- The nail will not be detected.
- The nail has been "discriminated out."



Quick-Start Demo continued on next page

QUICK-START DEMONSTRATION (continued)

VIII. Firmly press and release  once. DISC LVL will be activated. Press  until the words IRON, FOIL, NICKEL, P-TAB, S-CAP and ZINC all disappear.

IX. **Wave the Nickel over the searchcoil.**

a. The nickel will not be detected.

X. **Firmly press and release  two times. NOTCH will be activated. Press  twice.**

The word “NICKEL” will start flashing. Wait until the flashing stops. “NICKEL” will be illuminated.

XI. **Wave the Nickel over the Searchcoil.**

a. The nickel is now again detected.

b. The nickel has been “notched in.”

XII. Rotating the THRESH knob clockwise places the detector in All Metal Mode. Keep rotating the knob clockwise until you hear a faint hum. Pass the quarter over the searchcoil. Vary the distance from the searchcoil on each pass. Notice the changing pitch and volume.

XIII. **Press-and-hold**



- Notice motion is not required. A motionless object induces a sound.
- Notice the single audio tone. PINPOINT produces only this single tone, regardless of the type of metal detected.
- Vary the distance of the quarter to the searchcoil and notice the changing depth-display values. The 2-digit reading indicates depth distance in inches from the searchcoil.

XIV. **Return To Factory Default**

To reset the detector to the original factory default settings:

a. Turn off detector

b. Press and hold  and then turn detector on.

c. Release 

THE BASICS OF METAL DETECTING

A hobby metal detector is intended for locating buried metal objects. When searching for metals, underground or on the surface, you have the following challenges and objectives:

1. Ignoring signals caused by ground minerals.
2. Ignoring signals caused by metal objects that you do not want to find, like pull-tabs.
3. Identifying a buried metal object before you dig it up.
4. Estimating the size and depth of objects, to facilitate digging them up.
5. Eliminating the effects of electromagnetic interference from other electronic devices.

Your metal detector is designed with these things in mind.

1. Ground Minerals

All soils contain minerals. Signals from ground minerals can interfere with the signals from metal objects you want to find. All soils differ, and can differ greatly, in the type and amount of ground minerals present. You therefore want to “calibrate” the detector to the specific ground conditions where you are detecting. This detector incorporates both automated and manual ground-balancing features which will eliminate false signals from most types of soils. If you want to maximize the detector’s target identification accuracy and depth of detection, use the GROUND GRAB®. See the section on GROUND GRAB® Computerized Ground Balancing for details.

2. Trash

If searching for coins, which will induce higher tone sounds, you want to ignore items like aluminum foil, nails, and pull-tabs. These undesirable items induce lower tones. You can listen to the sounds of all objects detected, and decide on what you want to dig up. Or you can eliminate unwanted metals from detection by using the DISCRIMINATION features.

3. Identifying Buried Objects

When searching in the DISCRIMINATION Mode, different objects induce different tones (high, medium, low, bass) and are classified on the display screen in different categories. A 3-digit numerical reading is also provided in the middle of the display for more precise target identification. The DISCRIMINATION Mode requires motion: sweep the coil over the metal object.

4. Size and Depth of Buried Objects

When using the detector in the motion DISCRIMINATION Mode, the relative depth of an object is displayed in the center of the display with the SIGNAL strength indicator. A more accurate depth reading is available in a no-motion search, using PINPOINT. PinPoint displays approximate target depth in inches. This no-motion feature does not require the coil to be in motion to detect metals. The ability to hold the searchcoil motionless over the target also aids in tracing an outline of the buried object, or in pinpointing the exact location of the object using techniques described in the pinpointing section.

Basics of Metal Detections continued on next page

THE BASICS OF METAL DETECTING (continued)

5. EMI (Electromagnetic Interference)

The searchcoil produces a magnetic field and then detects changes in that magnetic field caused by the presence of metal objects. This magnetic field is susceptible to the electromagnetic energy produced by other electronic devices. Power lines, microwave ovens, lighting fixtures, TVs, computers, motors, etc., all produce EMI which can interfere with the detector and cause it to beep when no metal is present, and sometimes to beep erratically.

The GAIN control lets you reduce the strength of the magnetic field, and thereby lessen susceptibility to EMI. You may want to operate at maximum Gain, but the presence of EMI may make this impossible, so if you experience erratic behavior or “false” signals, **reduce the sensitivity**, by adjusting your GAIN and THRESHOLD controls.

HEADPHONE JACK

The detector has a 1/4” headphone jack on the left side of the housing.

When a headphone is connected, speaker audio is disabled. The headphone jack has a rubber plug that will keep dirt and moisture from entering the control box.

USING HEADPHONES

Using a detector with headphones facilitates detection of the weakest signals and also extends the battery life.

It also allows you to hear subtle changes in the sound more clearly, particularly if searching in a noisy location. For safety reasons, do not use headphones near traffic or where other dangers are present. This device is to be used with interconnecting cables/headphone cables shorter than three meters.

Headphone
Jack with
plug installed

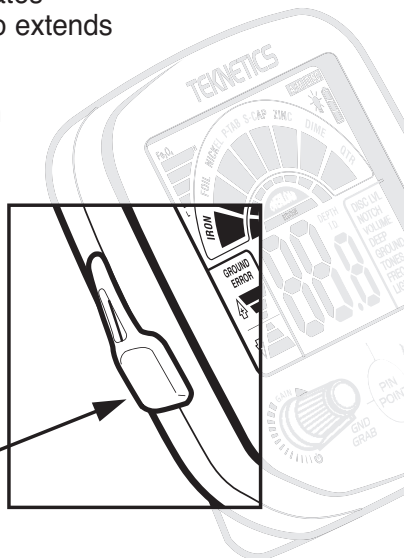

OPERATION and CONTROLS

DISPLAY AND CONTROLS

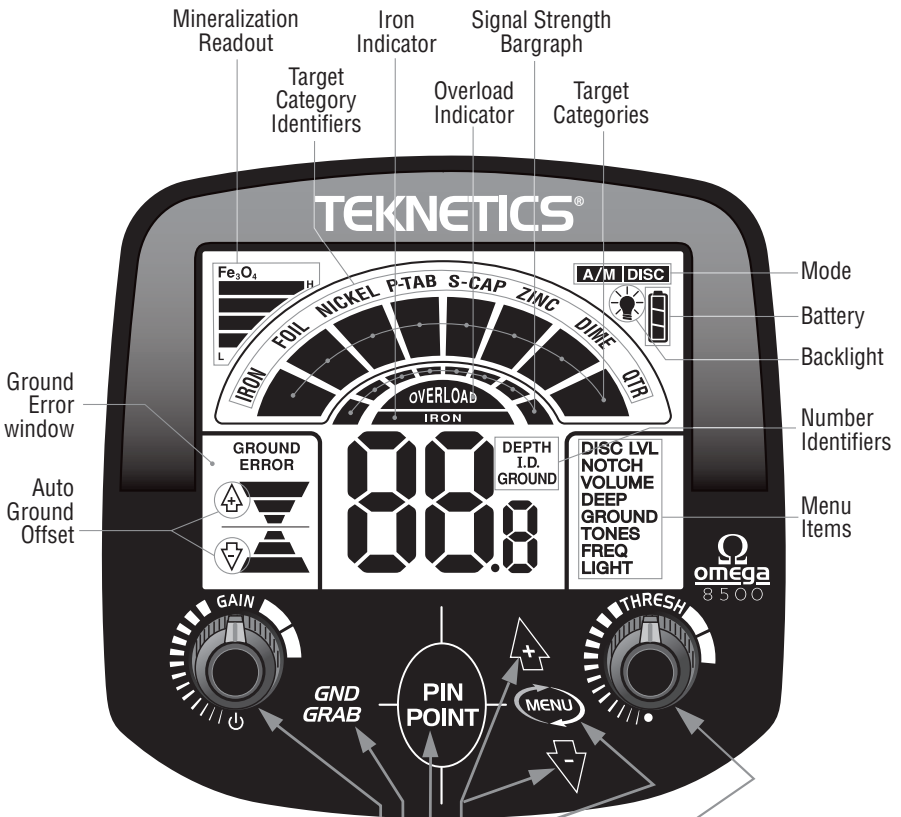

ON/OFF/GAIN: Click right to turn ON.
Turn knob to increase GAIN.

GND GRAB Press-and-hold key pad
to Ground Balance automatically.

PINPOINT Press-and-hold to pinpoint
target and view depth.
Alternate Function: Press once
while in VOLUME or GROUND
menu items, to enable
advanced options.

DISC/AM/THRESH Click left to enter
Disc mode; click right to enter
A/M mode. Turn knob to increase the
THRESHOLD setting.

MENU/QUICKSWITCH Firmly press and
release to activate the menu and change
the menu item. Press-and-hold to
momentarily change modes.

PLUS and MINUS Press keypads once
to modify the active menu item.
Press-and-hold to repeatedly modify
the active menu item.

OPERATION and CONTROLS (continued)

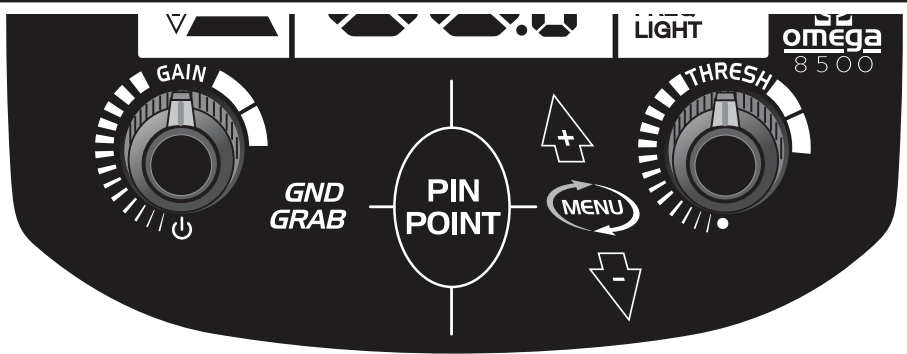

CONTROL KNOBS:

1. ON/OFF/GAIN:

- Click right to turn on. Click left to turn off.
- Turning the knob clockwise increases the detector's Gain; the higher the Gain, the deeper targets will be detected, and the more likely the detector will be able to detect very small targets.
- As you turn the knob, notice the value at the center of the screen will display your current Gain setting.
- We suggest keeping the GAIN below 70 until you become familiar with the detector's operation.
- At values greater than 70, some internal circuit noise will be noticed. The higher the number, the higher this background "static" will be. Many seasoned detectorists prefer to operate at high sensitivity level, with the accompanying noise. They call this "working into the noise". When some background level of noise is audible, small changes in the volume and tone will denote the presence of buried metal.

2. DISC/AM/THRESH

- Click clockwise to enter the All Metal Mode.
- This is the detector's most sensitive mode of operation.
- It is a motion mode of operation; the coil must be in motion to detect metal.
- All Metal Mode induces a hum whose pitch and volume vary with the size of the target. Larger targets and targets moving closer to the searchcoil will increase the tone's pitch and its volume.
- As you turn the knob, the THRESH value will be display at the center of the screen.
- Turning the knob clockwise increases the threshold, and allows more signal into the machine. At about zero threshold the noise floor should start becoming audible.
- See the section "Deep and Threshold settings interaction" (page 15).

Operation and Controls continued on next page

OPERATION and CONTROLS (continued)

Separate Gain and Threshold controls

The gain setting factors the amplitude of the signal coming from the coil. The threshold setting sets the minimum signal strength required to get a response, and audibly, the “hum” level in All Metal Mode. Together, these two settings control the overall sensitivity of the machine.

TOUCHPAD CONTROLS:



GND GRAB: Ground Grab® Computerized Ground Balancing.

This allows you to set the detector’s internal ground setting equal to the phase of the ground you are searching.

See the section on Ground Balancing (*page 19*), for a more throughout explanation of this feature.

Press-and-hold  to invoke automatic ground balancing. This will “grab” the ground value.

In order to determine the most accurate ground value, pump the coil up and down over the ground while standing in one place over a patch of ground-free of metal.

1. Locate a patch of metal free soil.
2. Start with the searchcoil about 6” above the ground. Press and hold  , lower and raise the coil to within an inch of the ground in a pumping motion.
3. Continue this pumping motion and watch the Ground Phase number in the center of the display.
4. Once this number remains constant, the detector has correctly measured the Ground Phase.
5. Release the  . This will internally set the Ground Phase to the value displayed.

To manually adjust the ground setting, see the “GROUND” menu item on page 16. If while performing Ground Grab, one of the arrows in the GROUND ERROR window is flashing, see the “Ground Grab Offset” section on page 17.

PINPOINT



Press and hold  to activate. Searchcoil motion is not required; a motionless searchcoil over a metal target will induce sound. Audio is VCO The 2 digit number displayed indicates target depth, in inches. The scale is calibrated to coin-sized objects.

After you have identified a target using a motion mode of detection, press and hold  to identify the target’s exact location. This technique can yield more information about the target’s shape and size and also find its exact location to facilitate extraction.



PINPOINT AS FOLLOWS:

1. Position the searchcoil just barely off the ground, and to the side of the target.
2. Press and hold .
3. Move the searchcoil slowly across the target and locate it by sound. The target is located directly below where the sound is the loudest.

OPERATION and CONTROLS (continued)

PINPOINT RETUNING

Retuning in Pinpoint Mode is useful in narrowing down the location of a target. To retune the detector, release the button and immediately depress it again.

1. To Narrow the response further, position the center of the searchcoil slightly off the center of the target, while still depressing .
2. Release .
3. Immediately press-and-hold again.
4. Repeat this procedure to narrow the field of detection further.

Note: Depth indication is less accurate after narrowing.

MENU/QUICK-SWITCH

This double function touchpad is used to activate and navigate the menu and to momentarily change modes. To operate the Menu, firmly press and release the touchpad. Note that the Menu actuates on the release of the touchpad. Press and Hold to momentarily switch modes.



MENU. The menu system packs the feature set in a dynamic and intuitive fashion. It also has extended hidden features for the advanced user.

Access: Press and release , to enable menu items.

QUICK SWITCH. Quick Switch alternates between ALL METAL and DISCRIMINATION Modes. It is useful when trying to listen a deeper target, or when trying to pinpoint the target without using the static signal.

Access: Press and hold  to alternate between DISCRIMINATION and ALL METAL Modes



PLUS and MINUS

Use  and  to modify and adjust the active menu item. Press and release once to modify menu items, or press and hold for continuous adjustment.

MENU ITEMS



DISC LVL: Discrimination Level

Discrimination allows you to eliminate metal objects from detection. It is adjustable from 0 to 80. A discrimination setting of zero is not the same as All Metal. Discrimination incurs some loss of sensitivity to small and deep objects. As you adjust the discrimination level, a number will appear in the center of the LCD. All targets that report a number LOWER than the set discrimination level will not report a sound or display activity. They have been eliminated from detection. Note also that target category identifiers will start disappearing from the top of the LCD screen as you increase the discrimination level. When a target icon disappears, it means the whole category has been eliminated from detection. Lowering the DISC LVL setting will make the target category identifiers return to the screen, even if they are partially eliminated by the numerical setting.

Access: Press and release the MENU/Quick-Switch button until DISC LVL menu item becomes active. Then use  and  to adjust the discrimination level.



NOTCH: Selective Target Inclusion or Exclusion

- a. The purpose of the NOTCH function is to change the detection status of a target category and it functions only in DISCRIMINATION Mode.
 - If a category was not eliminated from detection, then notching that category will eliminate it from detection and the category icon will disappear.
 - If a category was eliminated from detection (category's icon not illuminated), then notching the category will return the category to an active state and the icon will reappear.
- b. The following target categories can be notched in or out:
Foil, Nickel, P-Tab, S-Cap, Zinc, Dime, Qtr. After the Qtr category, pressing NOTCH will exit the NOTCH function.
- c. To select a category for notching, press NOTCH until the desired category identifier flashes. After a few seconds, the flashing will time out and the current target category will be notched.
- d. Practice pressing NOTCH a few times and its function will become obvious. The NOTCH feature is not available in ALL METAL Mode.

Access: Press and release  until NOTCH menu item becomes active. Then use  and  to select desired target category. Repeat the operation to notch additional categories.

VOLUME





The audio response is limited by the volume setting and it applies to all of the detector settings in all modes including user interface sounds and alarms. In addition to target volume it affects PINPOINT, Overload alarm, Ground Grab over metal alarm and all keypad button "beeps". It does NOT affect the sensitivity of the detector. The adjustable range is from 0 to 10.

Access: Press and release  until VOLUME menu item is activated. Use  and  to modify the audio volume.

MENU ITEMS (continued)

NOTCH VOLUME – Adjustable Volume Offset by Target Category

Each target category can have its volume adjusted independently. This advanced setting affects the Master Volume setting and functions only in DISCRIMINATION Mode.

Access: In Disc Mode, press and release  until VOLUME menu is activated. Press  repeatedly to cycle through the various target categories. NOTCH VOLUME will be displayed on the LCD and each category will blink when it is the active. Select desired category and use the  and  to set a negative notch volume offset. This offset will apply to the Master Volume setting. For example, if the master volume is set at 10, and your Notch Volume offset is -3, the volume for that target category will be at “7”. If you set an offset of -5, the volume would be “5”. Notch Volume range is from 0 to -9. Changing the master volume will change Notch Volume offsets accordingly. Make note when you set Notch Volume offsets because there is no indication on the screen when they are active.

DEEP

This allows 4 settings with varying filters that may increase depth under certain conditions.



- D0.**Fast filter. Best for target separation and searching in heavy trash. It is the least sensitive of the Deep settings.
- D1.**Regular filter. Best for general conditions.
- D2.**Deep filter plus 60 Hz notch. This is a slower return setting that will eliminate some EMI. The noise floor will be increased. This mode is best used in cleaner soils and Sensitivity must be adjusted for proper use.
- D3.**Deep filter plus 50 Hz notch. Same as D2, but with a 50 Hz noise filter.

Access: Press and release the  until DEEP menu is activated. Use  and  to select desired mode.

Deep and Threshold relationship. The DEEP Mode settings can affect the gain of the detector, most notable in the All Metal Mode. You may have to adjust the threshold. If Threshold knob seems ineffective, momentarily press  to reset internal offsets.



GROUND





This menu item allows you to manually change the ground balance setting. It is active only when in the All Metal Mode. By contrast, the Ground Grab feature automatically matches the detectors ground balance with the actual ground phase; with GROUND you can manually adjust it up or down. This can be beneficial, depending on the conditions you encounter. For example, if you are in very clean soil with no mineralization, you could adjust the GROUND setting up several digits. This would allow a slight increase the capability of the detector. Or if you are in highly mineralized soil and hearing a lot of “chatter” you could manually adjust the setting down several digits. This would quiet the detector down and allow you hear desirable targets easier.

Access: In All Metal Mode, press and release  until GROUND menu item becomes active. Then use  and  to modify the detectors ground setting. Adjust the setting while pumping the coil up and down. Some users prefer to manually adjust ground after a GROUND GRAB operation, to fine tune it. See the GROUND BALANCING section for more information.

MENU ITEMS (continued)

GROUND GRAB OFFSET

This advanced feature is only available while in the All Metal Mode. You can program an automatic Ground Grab offset, positive or negative. When an offset is programmed, you will see a visible indicator on the LCD each time you perform a Ground Grab. A “plus” or “minus” blinking arrow will displayed in the Ground Error section. ( )



Access: In All Metal Mode, press and release  until GROUND menu item becomes active. Then press . Use  and  to set a Ground Grab offset value. This number will be added or subtracted from the Ground Grab setting, depending on your entry.

TONES: Variable Tone Selections

In Discrimination Mode, the Omega 8500 has 5 different pre-set tone variations to choose from. See the table below detailing the settings of the 5 options. Select the option that best suits your needs or conditions.

d4 and d5 Tone Options



These two settings give the most varied audio tones and are identical except for one thing. The d5 Tone eliminates proportional audio and gives full audio response to even the smallest signals. This option is often preferred when searching for deep targets, enhancing the audio and making them very easy to hear. The d5 tone option also affects the Multiple Target Category System (see **Target-ID Indicators**, page 23.) Normally, the primary Target-ID indicator icon is black and the secondary target indicators will be grayed-out or half-tone. In d5 tone setting, both primary and secondary Target-ID indicators will be solid black. This will help when light conditions make it difficult to see the half-tone indicators.

Access: In Disc Mode, press and release  until TONES menu become enabled. Then use  and  to select desired tone option.

Setting	Iron	Foil	Nickel	Pulltab	S-Cap	Zinc	Dime	Qtr	
5	Bass	Low	Medium	Low	Low	Low	High	High	No Proportional audio
4	Bass	Low	Medium	Low	Low	Low	High	High	Proportional audio
3	Bass	Low	Low	Low	Low	Low	High	High	Proportional audio
2	Bass	Low	Low	Low	Low	Low	Low	Low	Proportional audio
1	VCO	VCO	VCO	VCO	VCO	VCO	VCO	VCO	Proportional audio

In All Metal Mode, the TONES feature allows the user to vary the pitch of the VCO tone by selecting one of four frequencies.

Variable VCO Tone. The audio pitch of the VCO base tone can be varied by selecting one of four pre-set frequencies. This allows users to select the base tone they are comfortable with.

Access: In All Metal Mode, use the Threshold knob to set a slightly audible threshold sound. Press and release  until TONES menu item is activated. Use the   to select one of the 4 tone options, A1 through A4. Note the change in audio pitch. This setting will carry over to all functions and modes using the VCO tone.

d5 Tone continued on next page

MENU ITEMS (continued)



FREQ: Frequency Shifting

If the detector chatters or is noisy while the coil is motionless, the cause is either internal circuit noise due to too high sensitivity setting or from electromechanical interference (EMI). If reducing the gain does not improve the operation, try switching between the alternate frequency settings. You may find a frequency option that eliminates the noise. Shifting the frequency may have an effect on the ground balance so as a precaution; we recommend you re-ground balance after changing the frequency.

Changing frequency may require you to change the ground balance setting. See section on ground balancing.

LIGHT: Adjustable Backlight

The Omega 8500 has an adjustable backlight option, with adjustments levels from 0 to 5 in increasing levels of intensity. Use of the backlight feature will drain the battery power at a faster rate.

Access: Press and release  until LIGHT menu item is activated. Use the  to select desired backlight setting. Use the "0" setting to turn backlight off.



NONVOLATILE MEMORY

The Omega 8500 will save in memory your settings when the detector is turned off, with the exception of the backlight and ground balance. Backlight default is OFF and Ground Balance is 82.9.

Access: Automatic when powering detector off.

RESET Function

This operation restores all the original factory default settings.

Access: Turn detector off. Press and hold  and turn detector on. The number displayed on the LCD is the software version. Release the  and the detector has been reset to default settings below.

Setting	Factory Default
DISC LVL	0
NOTCH	NONE
VOLUME	7
NOTCH VOLUME IRON	0
NOTCH VOLUME FOIL	0
NOTCH VOLUME NICKEL	0
NOTCH VOLUME P-TAB	0
NOTCH VOLUME S-CAP	0
NOTCH VOLUME ZINC	0

Setting	Factory Default
NOTCH VOLUME DIME	0
NOTCH VOLUME QTR	0
DEEP	1
GROUND	82.9
GROUND OFFSET	0
TONES DISC	d3
TONES A/M	A1
FREQ	0
LIGHT	0

GROUND BALANCING

WHAT IS GROUND BALANCING?

Why do I need to Ground Balance?

All soils contain minerals. Signals from ground minerals are often tens or hundreds of times as strong as the signal from a buried metal object. The magnetism of iron minerals, found in nearly all soils, causes one type of interfering signal. Dissolved mineral salts, found in some soils, are electrically conductive, causing another type of interfering signal.

Ground Balancing is the process by which the metal detector cancels the unwanted signals coming from the ground minerals while still detecting the signals from buried metal objects. This is accomplished by matching the detector's ground balance setting to the phase of the ground signal.

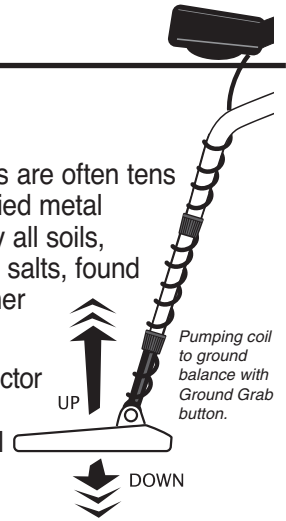

When the detector is calibrated to the soil, the result will be deeper target detection, quieter operation, and more accurate target identification.

How to Ground Balance your Detector:

1. Turn the detector on and set GAIN at the 12 o'clock position.
2. Click the right knob to All Metal Mode.
3. Adjust the THRESHOLD control knob to the point where you can hear a slight background hum.
4. Sweep searchcoil across the ground to find a clear patch of ground with no metal present.
5. Press and hold **GND GRAB** touch pad, and pump searchcoil repeatedly over the clean ground, keeping it level with the ground. Start about 6" above the ground and lower to within 1" of the ground. See illustration above.
6. When the ground phase value number displayed in the screen center settles down to an unchanging number, the detector has been ground balance. Release **GND GRAB** touch pad.

If during this process you see a blinking arrow in the Ground Error window that indicates an automatic GROUND GRAB OFFSET has been programmed.

Understanding ground conditions assists the user in setting up the detector, knowing when to readjust ground balance, and in understanding the responses of the detector while searching.

This detector provides two kinds of ground data:

1. The type of mineralization (which affects where the ground phase should be set.) This is **GND PHASE**.
2. The amount of mineralization (the greater the amount of mineralization, the greater the loss of detection depth & ID accuracy; the loss is more pronounced in Discrimination Mode. This is the **Fe₃O₄**.

Ground Balancing continued on next page

GROUND BALANCING -Technical Info

Fe₃O₄ BAR GRAPH

The Fe₃O₄ 4-segment bar graph indicates the amount of ground mineralization, independent of type, expressed as an equivalent volume concentration of magnetite (Fe₃O₄). It updates every second. It is sensitive to motion and will give the most accurate readings if you “pump” the searchcoil up and down several times over the ground. The presence of metal or “hot rocks” will cause the readings to be inaccurate. If you stop moving the searchcoil, the bar graph will go blank.

INDICATION	% Fe ₃ O ₄	SUSCEPTIBILITY
4 Bars -High	0.4 - 1.6	1,000 - 4,000
3 Bars -Medium	0.1 - 0.4	250 - 1,000
2 Bars -Low	0.025 - 0.1	60 - 250
1 Bars -Very Low	0.006 - .025	15 - 60
None - -	less than .006	less than 15

Magnetic susceptibility is expressed in micro-cgs units. In a salt water environment in the absence of iron minerals, the bar graph indicates relative electrical conductivity.

In soils with greater than 4,000 micro-cgs units magnetic susceptibility, the signal from the soil may saturate (“overload”) the circuits. This will not harm the detector but the machine will not be usable in that condition. The solution is to hold the searchcoil several inches above the soil surface so it isn’t “seeing as much dirt”. By listening and watching you will know how high you need to hold the searchcoil in order to avoid overload.

The highest magnetic susceptibilities are usually found in soils developed over igneous rocks, in alluvial “black sand” streaks on beaches, and in red clay soils of humid climates.

The lowest magnetic susceptibilities are usually found in white beach sands of tropical and subtropical regions, and soils developed over limestone.



Ground Error

The bottom left-hand corner of the display contains a graphic which indicates if your detector’s ground balance setting needs to be adjusted.

The Omega has a tracking system which continually analyzes the phase of the ground you are scanning. It then compares this *ground phase* value with the internal Ground Setting established at the time the detector was ground balanced using GND GRAB or the manual ground balance method.

- * If the detector’s internal Ground Setting is equal to the actual phase of the ground, the detector is properly ground balanced and the Ground Error window is clear.
- * When the detector’s internal Ground Setting is higher than the actual phase of the ground, the bars on the *top* of the graph will be illuminated. The bigger the error is, the more bars will show up.

GROUND ERROR (continued)

- * When the detector’s internal Ground Setting is lower than the actual phase of the ground, the bars on the *bottom* of the graph will be illuminated. The bigger the error is, the more bars will show up.
- * If the Ground Error *exceeds the level of three bars*,  or  will appear, indicating the maximum error has been reached, and action must be taken to adjust the Ground Setting.

To maintain maximum detector performance, keep the Ground Error to a minimum by adjusting the Ground Setting.

Before making an adjustment, it is best to verify the Ground Error as follows:



1. Place the detector into All Metal Mode.
2. Pump the searchcoil up and down over *a patch of ground free of metal*, repeatedly moving the coil to within 1” of the ground and lifting it up about 6” over the ground.

If bars appear at the top of the graph, manually **adjust** the Ground Setting negatively until all of the bars disappear. If bars appear at the bottom of the graph, manually **adjust** the Ground Setting positively until all of the bars disappear.

While in ALL METAL Mode, pumping the searchcoil over the ground, you will also hear audible evidence of an out-of-adjustment Ground Setting. If the Ground Setting is too low, there will be a difference in the sound as the searchcoil **is moving away** from the ground. It will sound like you are pulling the sound out of the ground. If the Ground setting is too high, it will sound like you are pushing the sound into the ground.

- If the sound is louder as you raise the searchcoil, manually adjust the ground setting to increase the ground balance setting.
- If the sound is louder as you lower the searchcoil, manually adjust the ground setting to reduce the ground balance setting.

GROUND ADJUSTMENT CHART

If bars appear	or in Auto-Tune pumping coil sounds like	then
AT TOP 	PUSHING SOUND OUT OF GROUND	DECREASE THE GROUND SETTING
AT BOTTOM 	PULLING SOUND INTO GROUND	INCREASE THE GROUND SETTING
NO BARS	SAME SOUND WHEN RAISING AND LOWERING	NO ADJUSTMENT NECESSARY

DEPTH AND TARGET DISPLAY

READING THE DISPLAY

The Liquid Crystal Display (LCD) shows the PROBABLE identification of the targeted metal, as well as the PROBABLE depth of the target.

The detector will register a consistent target identification, upon each sweep of the coil, when a buried target has been located and identified. If, upon repeated passes over the same spot, the target identification reads inconsistently, the target is probably a trash item, or oxidized metal. With practice, you will learn to unearth only the repeatable signals.

The segment identifications are highly accurate when detecting the objects described on the label. However, if an object registers in a given category for an unknown buried object, you could be detecting a metallic object other than the object described on the label, but with the same metallic signature. Also, the greater the distance between the target and the coil, the less accurate the target identification.

GOLD TARGETS Gold objects will register toward the middle or left-of-center on the LCD scale.

Gold flakes will register under iron.

Small gold items will register under foil or 5¢.

Large gold items will register toward the center of the scale.

SILVER TARGETS: Silver objects will register to the right of the scale, under DIME or QTR.

IRON: All sizes of iron objects will register on the far-left side of the scale. This could indicate on item such as a nail, or a historic iron relic.

FOIL: Aluminum foil, such as a gum wrapper, will register as foil. A small broken piece of pull tab may also register here.

NICKEL: Most newer pull-tabs from beverage cans, the type intended to stay attached to the can, will register here. Many gold rings will also register here.

P-TAB: Older pull tabs, which always detached completely from the can, register here. Many medium size gold ring also register here. Pull-tabs from older beverage cans will also register here. Some newer pull-tabs will also register here. Many gold rings will also register here.

S-CAP: Older screw caps from glass bottles will register here. Large gold rings, like a class ring, could also register here. Some non-U.S. coins of recent vintage will also register here.

Depth and Target Display continued on next page

DEPTH AND TARGET DISPLAY (continued)

Reading the display (cont.)

ZINC: Medium conductivity objects and many non-U.S. coins of recent vintage are classified here.

Caution: The target indications are visual references. Many other types of metal can fall under any one of these categories. While the detector will eliminate or indicate the presence of most common trash items, it is impossible to accurately classify ALL buried objects.

DEPTH INDICATOR:

The Depth Indicator is calibrated for coin-sized objects. It indicates the probable depth of the target, in inches.

While holding  and passing over a metal object, “DEPTH” will appear under to the two-digit number in the middle of the screen.

TARGET-ID INDICATORS (TID)

In Discrimination Mode the three-digit target indicator, in the middle of the LCD display, provides a specific target value to help identify buried targets. When in All Metal Mode, it is a two-digit number. With practice you will learn to associate target values with the probable identification of buried objects. The target value can vary each time the coil passes over the target, depending upon the angle of the object and the distance from the coil. For reference, see the chart on the next page for some common Target-ID numbers.

Note Discrimination and All Metal TID systems are separated. You can double-check Target-IDs by using the quick switch feature.

Multiple Target Category System.

This feature is available only in Discrimination Mode. For each target, the Omega 8500 calculates four independent numerical Target-ID's on each pass of the coil; one primary and three secondary. Each one of the Target-ID's will correlate to a target category on the LCD. There will be one solid primary category lighting up and up to three additional secondary target categories. All are different readings of the same target, with the primary category being the one with most reliable signal. If the Target-ID's vary, they will show up as multiple illuminated categories, and this could indicate the detector is picking up noise, a faint/weak signal or that the target is irregularly shaped.

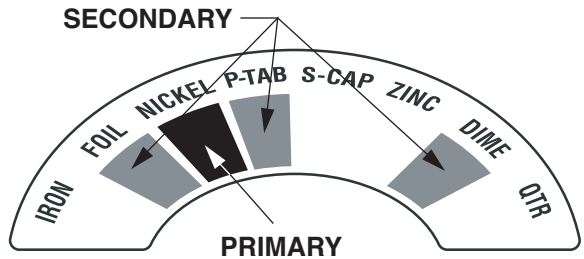

DEPTH AND TARGET DISPLAY (continued)

Reading the display (cont.)

Noise can trigger secondary TIDs without a primary, so it is possible to see secondary TID categories light up on the display, without a primary solid TID category.

Secondary Target-IDs don't produce any audio report and cannot be discriminated out. All the audio reports correspond to the primary TID, and any category that has been discriminated or notched out will not be able to display a primary TID or audio report. You will still have the benefit of all the secondary IDs even if the secondary IDs fall in categories that have been discriminated or notched out.

If you see only a primary TID, it means all primary and secondary TIDs agreed on that category.

A bottle cap that reads as iron in air will most likely have all TIDs agree that it is in fact iron. A bottle cap that reads as nickel or foil due to oxidation or orientation relative to the coil will most likely have TIDs disagree and several secondary TID categories will show up. All TIDs can agree and still miss-identify a target. Please use your skills as the ultimate discriminator.

IRON INDICATOR:

The iron indicator will react to every iron signal and promptly illuminate in the presence of iron. This signal is speed dependent, so it may blink rapidly if the coil is swung too fast. Heavily mineralized soil can also illuminate the Iron Segment Indicator.

In All Metal Mode, the iron indicator will be faded when over a weak iron signal or heavily mineralized ground. The iron indicator will be solid over strong iron targets.

TARGET Readout

The table below lists some common target values. With experience you will recognize many types of metal object by their numeric value.

TYPICAL VALUE	POSSIBLE OBJECTS
10-39	Iron
56-57	Nickel
60-62	Pull-Tab (old style)
62-65	Pull-Tab (new style)
66-72	Screw Cap
76-78	Zinc Penny
82-83	Dime & Copper Cent
86-87	Quarter
90-91	Half Dollar
94-95	Silver Dollar

SEARCH TECHNIQUES *(Motion modes)*

Target Verification

After detecting a target, do the following:

1. Walk around the target in a circle.

2. While circling the target, continue sweeping the searchcoil across the target.

3. Sweep once every 30° or 40° of the circle.

- If the tone does not change and the Target-ID value is consistent as you circle the target, you can be highly confident of the target's identification.

- If the tone or Target-ID changes as you circle the target, you may have multiple targets or an irregularly shaped object.

- If the tone completely disappears at different angles, the target may be trash or a low-value metal.

- If you are new to the hobby, dig all targets. With practice in the field, you will soon identify audible and visual target feedback with certain types of metal objects.

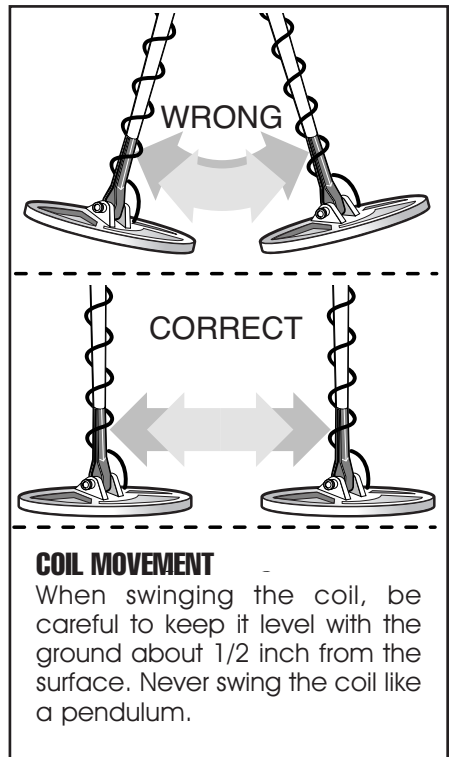

Pinpointing process in motion modes:

1. Sweep over target in narrowing side-to-side pattern.

2. Take visual note of spot on ground where “beep” occurs.

3. Rotate 90° to one side of the target.

4. Sweep coil over same area, at 90° to 1st sweep pattern.

5. This pinpoints the target location with an “X”.



TARGET PINPOINTING *(static search)*

After you have identified a target using a motion mode of detection, press-and-hold  to identify the target's exact location. This technique can yield more information about the target's shape and size and also find its exact location to facilitate extraction. Pinpoint also changes the readout to indicate target depth in inches.

Pinpoint as follows:

1. Position the searchcoil just barely off the ground and to the side of the target. Press and hold .
2. Now move the searchcoil slowly across the target, and you can locate it by the sound. The target is located directly under where the sound is loudest.

Narrow It Down:

1. To narrow the response further, position the center of the searchcoil near the center of the response pattern, but not directly over the center.
2. Release .
3. Press-and-hold  again.
4. Repeat this narrowing procedure to narrow the field of detection further.

Note: Depth indication is less accurate after narrowing.

COIL DRIFT

If you plan to use the PINPOINT Mode for continuous searching, realize that drift will occur over time, causing the detector to gain or lose sensitivity. Periodic retuning of the detector is required to minimize drift; release and press PINPOINT again to retune.

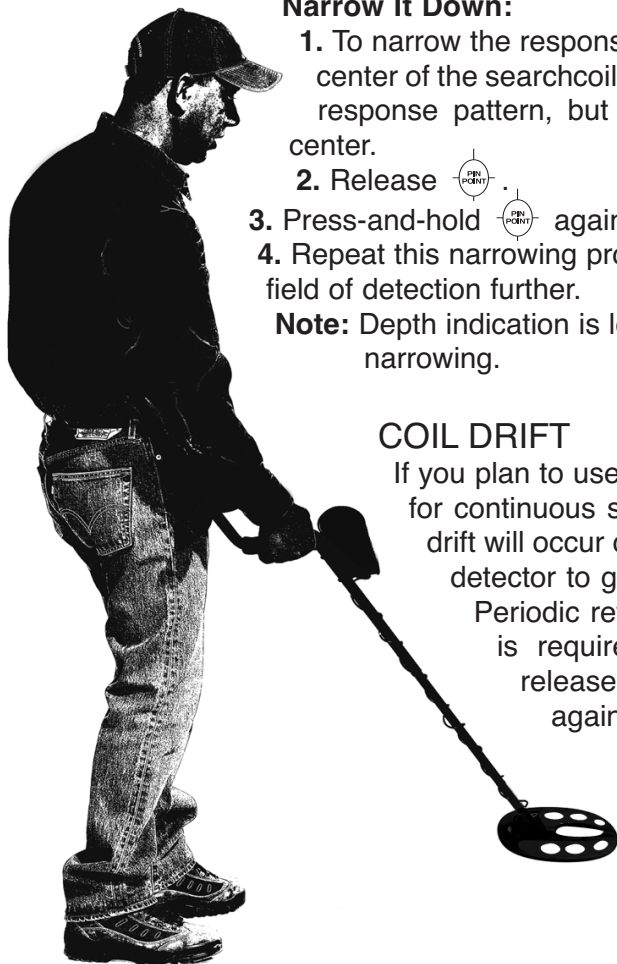

TREASURE HUNTER'S CODE OF ETHICS:

- Always check Federal, State, County and local laws before searching.
- Respect private property and do not enter private property without the owner's permission.
- Take care to refill all holes and leave no damage.
- Remove and dispose of any and all trash and litter found.
- Appreciate and protect our inheritance of natural resources, wildlife and private property.
- Act as an ambassador for the hobby, use thoughtfulness, consideration and courtesy at all times.
- Never destroy historical or archaeological treasures.
- All detectorists may be judged by the example you set; always conduct yourself with courtesy and consideration of others

5-YEAR LIMITED WARRANTY

Register your warranty on-line for a chance to win a
FREE DETECTOR
For details, visit www.tekneticst2.com

The **Omega** metal detector is warranted against defects in materials and workmanship under normal use for five years from the date of purchase to the original owner.

Damage due to neglect, accidental damage, or misuse of this product is not covered under this warranty. Decisions regarding abuse or misuse of the detector are made solely at the discretion of the manufacturer.

Proof of Purchase is required to make a claim under this warranty.

Liability under this Warranty is limited to replacing or repairing, at our option, the metal detector returned, shipping cost prepaid to First Texas Products. Shipping cost to First Texas Products is the responsibility of the consumer.

To return your detector for service, please first contact First Texas for a Return Authorization (RA) Number. Reference the RA number on your package and return the detector within 15 days of calling to:

First Texas Products L.L.C.
1465 Henry Brennan Dr.
El Paso, TX 79936
Phone: 915-633-8354

NOTE TO CUSTOMERS OUTSIDE THE U.S.A.

This warranty may vary in other countries, check with your distributor for details.
Warranty does not cover shipping costs.

According to FCC part 15.21 Changes or Modifications made to this device not expressly approved by the party responsible for compliance could void the users authority to operate this equipment.
This device complies with FCC Part 15 Subpart B Section 15.109 Class B.

Copyright© 2015 by First Texas Products, L.L.C.

All rights reserved, including the right to reproduce this book, or parts thereof, in any form, except for the inclusion of brief quotations in a review.

Published by First Texas Products, L.L.C.

Copyright© 2015

All rights reserved, including the right to reproduce this book, or parts thereof, in any form.

TEKNETICS®

1465 Henry Brennan • El Paso, TX 79936 • (915) 633-8354
MADE IN THE USA

ACCESSORIES

Teknetics® Padded Carrying Bag.

Made of rugged double-stitched nylon construction. Includes handy outside zip-pocket for extra batteries or small accessories. – *CBAG-T*

Teknetics® Camo Pouch

Camo pouch with two inside pockets, belt included. – *PCH-T*

Stereo Headphones

Use with Teknetics® metal detectors with true stereo. Utilizes 1/4-inch stereo & 1/8-inch plug. Compatible with all Teknetics® models with 1/4-inch & 1/8-inch jacks. – *HEADT*

Pinpointer

Pinpoints the exact location of buried metal objects. Audio signal indicator and vibrator. No assembly required, runs on (1) 9-Volt Battery. – *PINPOINTER*

Teknetics® Gold Pick

Tempered steel head is 10" long and the edge is 3 1/4" wide. The overall length is 19" with a durable fiberglass handle and a rubberized hand grip. Includes a powerful super magnet attached to the head to quickly discriminate iron targets and magnetic hot rocks. – *GOLDPICK*

Replacement/Accessory Searchcoils

11" Biaxial Standard Coil – *11COIL-TEK*

5" Biaxial Accessory Coil – *5COIL-TEK*

10" Elliptical Concentric Coil – *10COIL-TEK*

10" Biaxial Accessory Coil – *10COILDD-TEK*

Coil Covers

Specially made to protect your coil from abrasion and damage.

11" Biaxial Standard Coil Cover – *COVER-11DD*

5" Biaxial Coil Cover – *5COVER-CZ3*

Lesche Knife

Made from high quality heat-treated tempered steel. The ultimate digging tool. Comes with a durable sheath.

12" in length with a 7" serrated blade – *LESCHE KNIFE*

Teknetics® T-Shirt

100% cotton with Teknetics® Logo.

Sizes: S, M, LG, XL & XXL – *TKTSHIRT*

Teknetics® Baseball Cap

One size fits all. – *TKCAP*

Neoprene Face Rain Cover

Specially made to protect from weather – *FACE-COVER*

Gold Prospecting Kits

	Gold Kit PART NUMBER: GOLDKIT1	Deluxe Kit PART NUMBER: GOLDKIT2	Hardrock Kit PART NUMBER: GOLDKIT3
Items Included:			
10 1/2" Gold Pan	x	x	x
14" Gold Pan	x	x	x
Classifier		x	x
2 Shatterproof Vials	x	x	x
Snuffer Bottle	x	x	x
Black Sand Magnet		x	x
Treasure Scoop		x	x
Tweezers			x
Magnifier			x
Crevice Tool			x
Rock Pick			x
Instruction Booklet	x	x	x
Backpack		x	x

FOR COMPLETE DETAILS VISIT WWW.TEKNETICST2.COM • 1-800-413-4131