

AZEA 3260

WITH INTEGRATED TILING FLANGE AND SKIRT

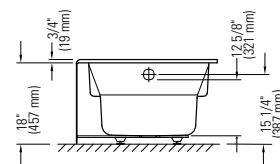

59 3/4" x 31 7/8" x 18" [54 gallons]

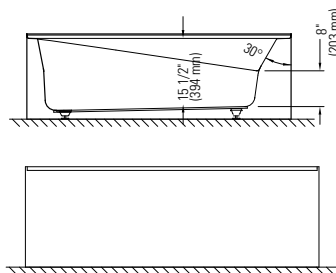
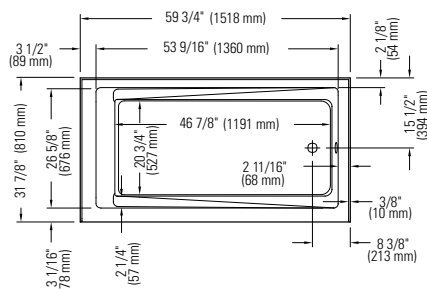

GENERAL SPECIFICATIONS

- Acrylic thermoformed and reinforced with fiberglass
- Gloss finish resistant to stains and discoloration
- Immersion 12 5/8" - Adjustable legs
- Weight: 68 pounds

GENERAL OPTIONS

Acrylic colors: white
 biscuit* or bone* (allow 3 weeks for delivery)
 Available in left or right version (integrated tiling flange)
 Integrated skirt

White mood light: white, biscuit, bone or chrome finish

Handle: white, biscuit, bone or chrome finish 95.7077.106.XX
 (max. 2) (submit drawing with order)

Drain D105 (20"): chrome finish 62.4020.102.60

Black neck pillow (12" x 4") 18.6000.100.20

WHIRLPOOL OPTIONS

Finish for Whirlpool jets: white, biscuit or bone
 Other: chrome

Inline heater 110 V

ACTIV-AIR OPTIONS

Finish for Activ-Air jets: white, biscuit or bone
 Other: chrome

Blower hose extension 36" 95.5013.116.00

Blower hose extension 72" 95.5013.167.00

Blower hose extension 96" 95.5013.168.00

Blower extensions are necessary when the blower is located more than 4' from the pneumatic control.

DIMENSIONS ARE NOMINAL AND MAY VARY BY ± 1/4" (6MM).
 WEIGHT MAY VARY BY ± 5 LBS (2,3KG).
 DRAWING IS NOT SCALE. THESE DIMENSIONS MAY BE CHANGED AT THE MANUFACTURER'S DISCRETION.
 CONSULT THE INSTALLATION GUIDE FOR MORE INFORMATION.

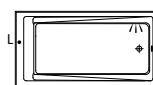

Bathtub only left drain E10.21512.5500
 Bathtub only right drain E10.21512.5000

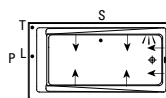

Whirlpool left drain E15.21512.550030
 Whirlpool right drain E15.21512.500030
 Included: 6 round jets, two air controls, one 7.5 A (120 V) pump and one pneumatic control.

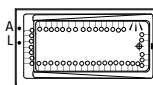

Activ-Air left drain E15.21512.550010
 Activ-Air right drain E15.21512.500010
 Included: 32 Activ-Air micro-jets, one blower 9.5 A (120 V) with heating element (200 W) and one pneumatic control.

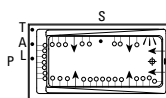

Whirlpool/Activ-Air combo left drain E15.21512.550031
 Whirlpool/Activ-Air combo right drain E15.21512.500031
 Included: 6 round jets, 30 Activ-Air micro-jets, two air controls, one 7.5 A pump (120 V), one blower 9.5 A (120 V) with heating element (200 W) and two pneumatic controls.

- ➔ : Whirlpool jets
- : Activ-Air jets
- S : Suction
- T : Whirlpool control
- A : Activ-Air control
- P : Pump
- L : Light control
- ≡ : Mood light (option)

Note: The blower is never installed.



COMPLIANCE ATTESTATION
 Standard bathtubs
 CAN / CSA.B45.5
 Hydromassage Standards
 CAN / CSA.B45.10 / CSA.C22.2 / UL-1795



Certification ECORESPONSIBLE
 First manufacturer of bathroom products in North America to be certified ecoresponsible.



Produits Neptune

ENTREPRENEUR

6635, Picard street, Saint-Hyacinthe (Quebec) J2S 1H3
 Phone: (450) 773-7058 - Fax: (450) 773-5063
 produitsneptune.com

AZEA 3260

WITH INTEGRATED TILING FLANGE AND SKIRT



59 3/4" x 31 7/8" x 18" [54 gallons]

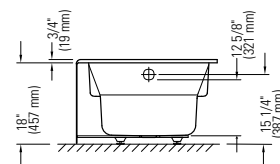
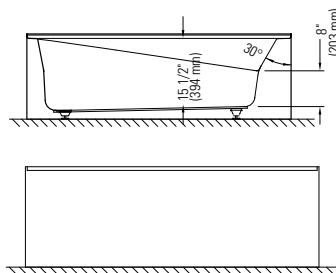
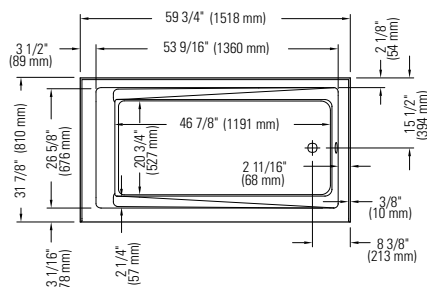

GENERAL SPECIFICATIONS

- Acrylic thermoformed and reinforced with fiberglass
- Gloss finish resistant to stains and discoloration
- Immersion 12 5/8" - Adjustable legs
- Weight: 68 pounds

GENERAL OPTIONS

Acrylic colors: white
 biscuit* or bone* (allow 3 weeks for delivery)
 Available in left or right version (integrated tiling flange)
 Integrated skirt

White mood light: white, biscuit, bone or chrome finish

Handle: white, biscuit, bone or chrome finish 95.7077.106.XX
 (max. 2) (submit drawing with order)

Drain D105 (20"): chrome finish 62.4020.102.60

Black neck pillow (12" x 4") 18.6000.100.20

WHIRLPOOL OPTIONS

Finish for Whirlpool jets: white, biscuit or bone
 Other: chrome

Inline heater 110 V

ACTIV-AIR OPTIONS

Finish for Activ-Air jets: white, biscuit or bone
 Other: chrome

Blower hose extension 36" 95.5013.116.00

Blower hose extension 72" 95.5013.167.00

Blower hose extension 96" 95.5013.168.00

Blower extensions are necessary when the blower is located more than 4' from the pneumatic control.

DIMENSIONS ARE NOMINAL AND MAY VARY BY ± 1/4" (6MM).
 WEIGHT MAY VARY BY ± 5 LBS (2,3KG).
 DRAWING IS NOT SCALE. THESE DIMENSIONS MAY BE CHANGED AT THE MANUFACTURER'S DISCRETION.
 CONSULT THE INSTALLATION GUIDE FOR MORE INFORMATION.

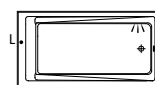

Bathtub only left drain E10.21512.5500
 Bathtub only right drain E10.21512.5000

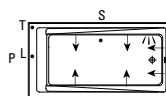

Whirlpool left drain E15.21512.550030
 Whirlpool right drain E15.21512.500030
 Included: 6 round jets, two air controls,
 one 7.5 A (120 V) pump and one pneumatic control.

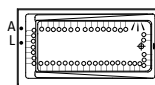

Activ-Air left drain E15.21512.550010
 Activ-Air right drain E15.21512.500010
 Included: 32 Activ-Air micro-jets,
 one blower 9.5 A (120 V) with heating element (200 W) and one pneumatic control.

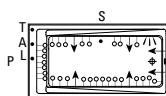

Whirlpool/Activ-Air combo left drain E15.21512.550031
 Whirlpool/Activ-Air combo right drain E15.21512.500031
 Included: 6 round jets, 30 Activ-Air micro-jets,
 two air controls, one 7.5 A pump (120 V), one blower
 9.5 A (120 V) with heating element (200 W) and two
 pneumatic controls.

- ➔ : Whirlpool jets
- : Activ-Air jets
- S : Suction
- T : Whirlpool control
- A : Activ-Air control
- P : Pump
- L : Light control
- ≡ : Mood light (option)

Note: The blower is never installed.



COMPLIANCE ATTESTATION
 Standard bathtubs
 CAN / CSA.B45.5
 Hydromassage Standards
 CAN / CSA.B45.10 / CSA.C22.2 / UL-1795



Certification ECORESPONSIBLE
 First manufacturer of bathroom products in
 North America to be certified ecoresponsible.



Produits Neptune

ENTREPRENEUR

6635, Picard street, Saint-Hyacinthe (Quebec) J2S 1H3
 Phone: (450) 773-7058 - Fax: (450) 773-5063
 produitsneptune.com



Produits Neptune

AZEA 3260 WITH INTEGRATED TILING FLANGE AND SKIRT

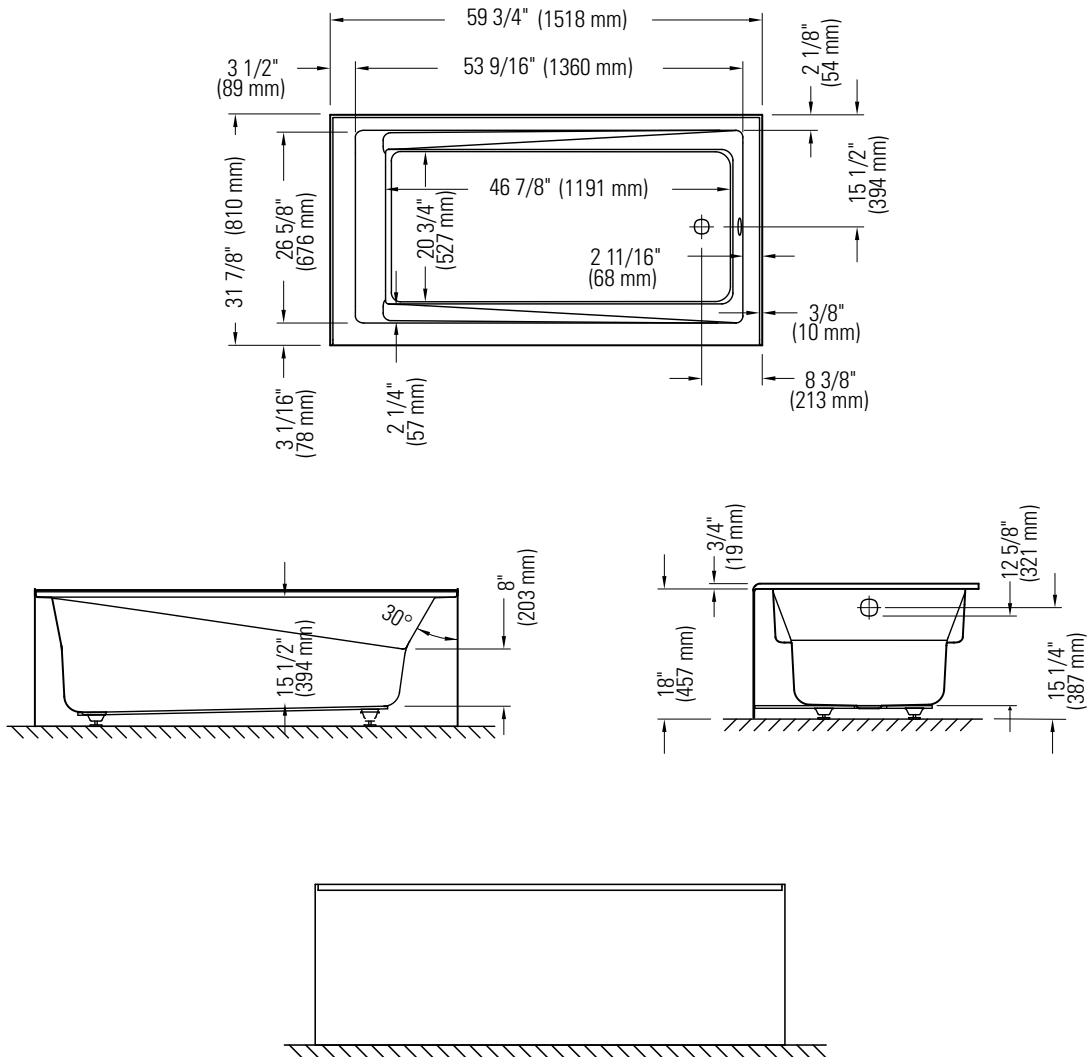

*All dimensions are approximate and subject to change without notice.
Please refer to the installation guide before beginning the installation.